

Technology Data for Energy Plants for Electricity and District heating generation

August 2016

Danish Energy Agency

Amaliegade 44
DK-1256 Copenhagen K

P: +45 3392 6700
E: ens@ens.dk

www.ens.dk

Amendment sheet

Publication date

Publication date for this catalogue “Technology Data for Energy Plants” is august 2016. In June 2017 this amendment sheet has been added and also the possibility to add descriptions of amendments in the individual chapters if required. Hereby the catalogue can be updated continuously as technologies evolve, if the data changes significantly or if errors are found.

The newest version of the catalogue will always be available from the Danish Energy Agency’s web site.

Amendments after publication date

All updates made after the publication date will be listed in the amendment sheet below.

Date	Ref.	Description
November 18	Introduction to Peak Power Plants and Reserve Technologies, 50 Diesel Engine Farm, 51 Natural Gas Engine Plant, 52 Open Cycle Gas Turbine	Chapters added
October 18	03 Rebuilding Large Coal Power Plants to Biomass	Datasheets updated
October 18	07 CCS, 10 Stirling engines, 22 PV, 23 Wave energy, 45 Geothermal DH	Chapters transferred from previous catalogue
October 18	46 Solar District Heating	Qualitative description and datasheets updated
October 18	01 Advanced Pulverized Fuel Power Plant	Qualitative description updated
September 18	08, 09, 42, 43, 99 Biomass and waste section	Description of WtE (08) and Biomass (09) updated. CHP and HOP descriptions have been merged for WtE and Biomass respectively and Introduction, Biomass and Waste sections moved
July 18	22 Photovoltaics	Datasheets for small residential and medium commercial size systems updated
March 18	99 Introduction, Biomass and Waste	Chapter added that gives a common introduction to the biomass and waste sheets (chapter 08, 09, 42 and 43)

	sections	
March 18	08,09,42,43 Waste and Biomass CHP and boilers	Datasheet included, chapters will be included soon
March 18	11 Solid oxide fuel cell CHP (Natural gas/biogas)	Chapter added
March 18	12 Low temperature proton exchange membrane fuel cell CHP (hydrogen)	Chapter added
January 18	05 Combined cycle gas turbine	Additional references have been included
January 18	06 Gas engines	Reference sheet have been updated
January 18	40 Heat pumps, DH and 44 gas fired DH boiler	Updated prices for auxiliary electricity consumption in data sheet
November 2017	01 Advanced Pulverized Fuel Power Plant	Datasheet for Advanced Pulverized Fuel Power Plant - Coal CHP included
October 2017	22 Photovoltaics	Datasheet for large ground mounted PV plants included
June 17	Preface	Small changes explaining the amendment sheet
June 17	21 Wind Turbines Offshore	Financial data (Investment cost and O&M) updated
June 17	41 Electric Boilers	Revised chapter added

Preface

The *Danish Energy Agency* and *Energinet*, the Danish transmission system operator, publish catalogues containing data on technologies for Energy Plants. This current catalogue includes updates of a number of technologies which replace the corresponding chapters in the previous catalogue published in May 2012 with updates published in October 2013, January 2014 and March 2015. The intention is that all technologies in the previous catalogue will be updated and represented in this catalogue. Also the catalogue will continuously be updated as technologies evolve, if data change significantly or if errors are found. All updates will be listed in the amendment sheet on the previous page and in connection with the relevant chapters, and it will always be possible to find the most recently updated version on the Danish Energy Agency's website.

The primary objective of publishing technology catalogues is to establish a uniform, commonly accepted and up-to-date basis for energy planning activities, such as future outlooks, evaluations of security of supply and environmental impacts, climate change evaluations, as well as technical and economic analyses, e.g. on the framework conditions for the development and deployment of certain classes of technologies.

With this scope in mind, it is not the target of the technology data catalogues, to provide an exhaustive collection of specifications on all available incarnations of energy technologies. Only selected, representative, technologies are included, to enable generic comparisons of technologies with similar functions in the energy system e.g. thermal gasification versus combustion of biomass or electricity storage in batteries versus fly wheels.

Finally, the catalogue is meant for international as well as Danish audiences in an attempt to support and contribute to similar initiatives aimed at forming a public and concerted knowledge base for international analyses and negotiations.

Data sources and results

A guiding principle for developing the catalogue has been to rely primarily on well-documented and public information, secondarily on invited expert advice. Where unambiguous data could not be obtained, educated guesses or projections from experts are used. This is done to ensure consistency in estimates that would otherwise vary between users of the catalogue.

Cross-cutting comparisons between technologies will reveal inconsistencies which may have several causes:

- Technologies may be established under different conditions. As an example, the costs of off-shore wind farms might be established on the basis of data from ten projects. One of these might be an R&D project with floating turbines, some might be demonstration projects, and the cheapest may not include grid connections, etc. Such a situation will result in inconsistent cost estimates in cases where these differences might not be clear.
- Investors may have different views on economic attractiveness and different preferences. Some decisions may not be based on mere cost-benefit analyses, as some might tender for a good architect to design their building, while others will buy the cheapest building.
- Environmental regulations vary from between countries, and the environment-related parts of the investment costs, are often not reported separately.
- Expectations for the future economic trends, penetration of certain technologies, prices on energy and raw materials vary, which may cause differences in estimates.
- Reference documents are from different years. The ambition of the present publication has been to reduce the level of inconsistency to a minimum without compromising the fact that the real world is ambiguous. So, when different publications have presented different data, the publication which appears most in compliance with other publications has been selected as reference.

In order to handle the above mentioned uncertainties, each catalogue contains an introductory chapter, stating the guidelines for how data have been collected, estimated and presented. These guidelines are not perfect, but they represent the best balance between various considerations of data quality, availability and usability.

Danish preface

Energistyrelsen og Energinet udarbejder teknologibeskrivelser for en række el- og varmeproduktionsteknologier. Dette nuværende katalog indeholder opdateringer af en stor del af teknologibeskrivelserne, som erstatter de tilsvarende kapitler i det gamle katalog, som blev udgivet i 2012 og senere opdateret i 2013, 2014 og 2015. Det er hensigten, at alle teknologibeskrivelserne fra det gamle katalog skal opdateres og integreres her. Desuden vil kataloget løbende opdateres i takt med at teknologierne udvikler sig, hvis data ændrer sig væsentligt eller hvis der findes fejl. Alle opdateringer vil registreres i rettelsesbladet først i kataloget, og det vil altid være muligt at finde den seneste opdaterede version på Energistyrelsens hjemmeside.

Hovedformålet med teknologikataloget er at sikre et ensartet, alment accepteret og aktuelt grundlag for planlægningsarbejde og vurderinger af forsyningssikkerhed, beredskab, miljø og markedsudvikling hos bl.a. de systemansvarlige selskaber, universiteterne, rådgivere og Energistyrelsen. Dette omfatter for eksempel fremskrivninger, scenarieanalyser og teknisk-økonomiske analyser.

Desuden er teknologikataloget et nyttigt redskab til at vurdere udviklingsmulighederne for energisektorens mange teknologier til brug for tilrettelæggelsen af støtteprogrammer for energiforskning og -udvikling. Tilsvarende afspejler kataloget resultaterne af den energirelaterede forskning og udvikling. Også behovet for planlægning og vurdering af klima-projekter har aktualiseret nødvendigheden af et opdateret databeredskab.

Endeligt kan teknologikataloget anvendes i såvel nordisk som internationalt perspektiv. Det kan derudover bruges som et led i en systematisk international vidensopbygning og -udveksling, ligesom kataloget kan benyttes som dansk udspil til teknologiske forudsætninger for internationale analyser og forhandlinger. Af disse grunde er kataloget udarbejdet på engelsk.

Tabel of Contents

Amendment sheet.....	2
Preface	3
Danish preface.....	5
Tabel of Contents	6
Introduction	8
01 Supercritical Pulverized Fuel Power Plant	27
02 Life Time Extensions of Coal Power Plants	41
03 Rebuilding Large Coal Power Plants to Biomass	48
04 Gas Turbine, Simple-Cycle.....	64
05 Gas Turbine Combined-Cycle	73
06 Gas Engines.....	81
07 CO ₂ Capture and Storage.....	89
Introduction to Waste and Biomass plants	97
08 WtE CHP and HOP plants	110
09 Biomass CHP and HOP plants	129
10 Stirling engines, gasified biomass	167
11 Solid oxide fuel cell CHP (natural gas/biogas)	170
12 Low temperature proton exchange membrane fuel cell CHP (hydrogen)	179
20 Wind Turbines onshore.....	185
21 Wind Turbines, Offshore.....	209
22 Photovoltaics	233
23 Wave Energy.....	249
40 Heat pumps	253

41 Electric Boilers	270
42 WtE HOP (go to chapter 08)	279
43 Biomass Fired HOP (go to chapter 09).....	279
44 District Heating Boiler, Gas Fired	280
45 Geothermal District Heating	285
46 Solar District Heating	294
Introduction to Peak Power Plants and Reserve Technologies.....	312
50 Diesel Engine Farm.....	320
51 Natural Gas Engine Plant	328
52 Open Cycle Gas Turbine	336
ANNEX 1: FEATURES OF STEAM EXTRACTION TURBINES	346
ANNEX 2: Emissions limitations for peak- and reserve plants	349

Introduction

This catalogue covers data regarding energy plants for generation of electricity and district heating. Three distinct categories of plants are included:

- **Heat-only generation:** technologies producing only heat to be provided to the district heating network (e.g. boilers and heat pumps);
- **Thermal electricity generation:** plants producing electricity with thermal processes (for example steam cycle or internal combustion engines), including combined heat and power plants (CHP).
- **Non-thermal electricity generation:** technologies producing electricity without thermal processes, such as wind power, solar power or hydroelectric power plants.

The main purpose of the catalogue is to provide generalized data for analysis of energy systems, including economic scenario models and high-level energy planning.

These guidelines serve as an introduction to the presentations of the different technologies in the catalogue, and as instructions for the authors of the technology chapters. The general assumptions are described in the section below. The following sections (1.2 and 1.3) explain the formats of the technology chapters, how data were obtained, and which assumptions they are based on. Each technology is subsequently described in a separate technology chapter, making up the main part of this catalogue. The technology chapters contain both a description of the technologies and a quantitative part including a table with the most important technology data.

General assumptions

The boundary for both cost and performance data is the generation assets plus the infrastructure required to deliver the energy to the main grid. For electricity, this is the nearest land-based substation of the transmission/distribution grid, while district heat is delivered to the nearest district heating network. In other words, the technologies are described as they are perceived by the electricity or district heating systems receiving their energy deliveries. Thus, stated capacities are net capacities, which are calculated as the gross generation capacity minus the auxiliary power consumption “capacity” at the plant. Similarly, efficiencies are also net efficiencies.

Unless otherwise stated, the thermal technologies in the catalogue are assumed to be designed and operated for approx. 4000-5000 full load hours annually. 75 % of generation is expected to take place in full load and the remaining 25 % in part load. Some of the exceptions are municipal solid waste incineration facilities and stand-alone biogas plants, which are designed for continuous operation, i.e. approximately 8000 full load hours annually. The assumed numbers of full load hours are summarized in table 1.

For electricity and heat production technologies dependent on wind and solar resources, estimates of annual full load hours of production are made for each technology.

	Full load hours (electricity)	Full load hours (heat)
CHP back pressure units	4000	4000
CHP extraction units	5000	4000
Municipal solid waste / biogas stand alone	8000	8000
Boilers and heat pumps		4000
Geothermal heat		6000
Electric boilers		500

Table 1: Assumed number of full load hours.

1.2. Qualitative description

The qualitative description describes the key characteristics of the technology as concise as possible. The following paragraphs are included where relevant for the technology.

Contact information

Containing the following information:

- Contact information: Contact details in case the reader has clarifying questions to the technology chapters. This could be the Danish Energy Agency, Energinet.dk or the author of the technology chapters.
- Author: Entity/person responsible for preparing the technology chapters
- Reviewer: Entity/person responsible for reviewing the technology chapters.

Brief technology description

Brief description for non-engineers of how the technology works and for which purpose.

An illustration of the technology is included, showing the main components and working principles.

Input

The main raw materials and primarily fuels, consumed by the technology.

Output

The forms of generated energy, i.e. electricity and heat, and any relevant by-products.

Typical capacities

The stated capacities are for a single unit capable of producing energy (e.g. a single wind turbine or a single gas turbine), not a power plant consisting of a multitude of unit such as a wind farm.

In the case of a modular technology such as PV or solar heating, a typical size of a solar power plant based on the market standard is chosen as a unit. Different sizes may be specified in separated tables, e.g. Small PV, Medium PV, Large PV.

Space requirement

Space requirement is expressed in 1000 m² per MW. The value presented only refers to the area occupied by the facilities needed to produce energy.

In case the area refers to the overall land use necessary to install a certain capacity, or a certain minimum distance from dwellings is required, for instance in case of a wind farm, this is specified in the notes. The space requirements may for example be used to calculate the rent of land, which is not included in the financial cost, since this cost item depends on the specific location of the plant.

Regulation ability and other power system services

Regulation abilities are particularly relevant for electricity generating technologies. This includes the part-load characteristics, start-up time and how quickly it is able to change its production when already online.

If relevant, the qualitative description includes the technology's capability for delivering the following power system services:

- Inertia
- Short circuit power
- Black start
- Voltage control
- Damping of system oscillations (PSS)

Advantages/disadvantages

A description of specific advantages and disadvantages relative to equivalent technologies. Generic advantages are ignored; e.g. renewable energy technologies mitigating climate risks and enhance security of supply.

Environment

Particular environmental characteristics are mentioned, for example special emissions or the main ecological footprints.

The energy payback time or energy self-depreciation time may also be mentioned. This is the time required by the technology for the production of energy equal to the amount of energy that was consumed during the production and the installation of the equipment.

Research and development perspectives

This section lists the most important challenges to further development of the technology. Also, the potential for technological development in terms of costs and efficiency is mentioned and quantified if possible. Danish research and development perspectives are highlighted, where relevant.

Examples of market standard technology

Recent full-scale commercial projects, which can be considered market standard, are mentioned, preferably with links. A description of what is meant by “market standard” is given in the introduction to the quantitative description section. For technologies where no market standard has yet been established, reference is made to best available technology in R&D projects.

Prediction of performance and costs

Cost reductions and improvements of performance can be expected for most technologies in the future. This section accounts for the assumptions underlying the cost and performance in 2015 as well as the improvements assumed for the years 2020, 2030 and 2050.

The specific technology is identified and classified in one of four categories of technological maturity, indicating the commercial and technological progress, and the assumptions for the projections are described in detail.

In formulating the section, the following background information is considered:

Data for 2015

In case of technologies where market standards have been established, performance and cost data of recent installed versions of the technology in Denmark or the most similar countries in relation to the specific technology in Northern Europe are used for the 2015 estimates.

If consistent data are not available, or if no suitable market standard has yet emerged for new technologies, the 2015 costs may be estimated using an engineering based approach applying a decomposition of manufacturing and installation costs into raw materials, labor costs, financial costs, etc. International references such as the IEA, NREL etc. are preferred for such estimates.

Assumptions for the period 2020 to 2050

According to the IEA:

“Innovation theory describes technological innovation through two approaches: the technology-push model, in which new technologies evolve and push themselves into the marketplace; and the market-pull model, in which a market opportunity leads to investment in R&D and, eventually, to an innovation” [6].

The level of “market-pull” is to a high degree dependent on the global climate and energy policies. Hence, in a future with strong climate policies, demand for e.g. renewable energy technologies will be higher, whereby innovation is expected to take place faster than in a situation with less ambitious policies. This is expected to lead to both more efficient technologies, as well as cost reductions due to economy of scale effects. Therefore, for technologies where large cost reductions are expected, it is important to account for assumptions about global future demand.

The IEA’s New Policies Scenario provides the framework for the Danish Energy Agency’s projection of international fuel prices and CO₂-prices, and is also used in the preparation of this catalogue. Thus, the

projections of the demand for technologies are defined in accordance with the thinking in the New Policies Scenario, described as follows:

“New Policies Scenario: A scenario in the World Energy Outlook that takes account of broad policy commitments and plans that have been announced by countries, including national pledges to reduce greenhouse gas emissions and plans to phase out fossil energy subsidies, even if the measures to implement these commitments have yet to be identified or announced. This broadly serves as the IEA baseline scenario” [7].

Alternative projections may be presented as well relying for example on the IEA’s 450 Scenario (strong climate policies) or the IEA’s Current Policies Scenario (weaker climate policies).

Learning curves and technological maturity

Predicting the future costs of technologies may be done by applying a cost decomposition strategy, as mentioned above, decomposing the costs of the technology into categories such as labor, materials, etc. for which predictions already exist. Alternatively, the development could be predicted using learning curves. Learning curves express the idea that each time a unit of a particular technology is produced, learning accumulates, which leads to cheaper production of the next unit of that technology. The learning rates also take into account benefits from economy of scale and benefits related to using automated production processes at high production volumes.

The potential for improving technologies is linked to the level of technological maturity. The technologies are categorized within one of the following four levels of technological maturity.

Category 1. Technologies that are still in the *research and development phase*. The uncertainty related to price and performance today and in the future is highly significant (e.g. wave energy converters, solid oxide fuel cells).

Category 2. Technologies in the *pioneer phase*. The technology has been proven to work through demonstration facilities or semi-commercial plants. Due to the limited application, the price and performance is still attached with high uncertainty, since development and customization is still needed. The technology still has a significant development potential (e.g. gasification of biomass).

Category 3. *Commercial technologies with moderate deployment*. The price and performance of the technology today is well known. These technologies are deemed to have a certain development potential and therefore there is a considerable level of uncertainty related to future price and performance (e.g. offshore wind turbines)

Category 4. *Commercial technologies, with large deployment*. The price and performance of the technology today is well known and normally only incremental improvements would be expected. Therefore, the future price and performance may also be projected with a relatively high level of certainty. (e.g. coal power, gas turbine)

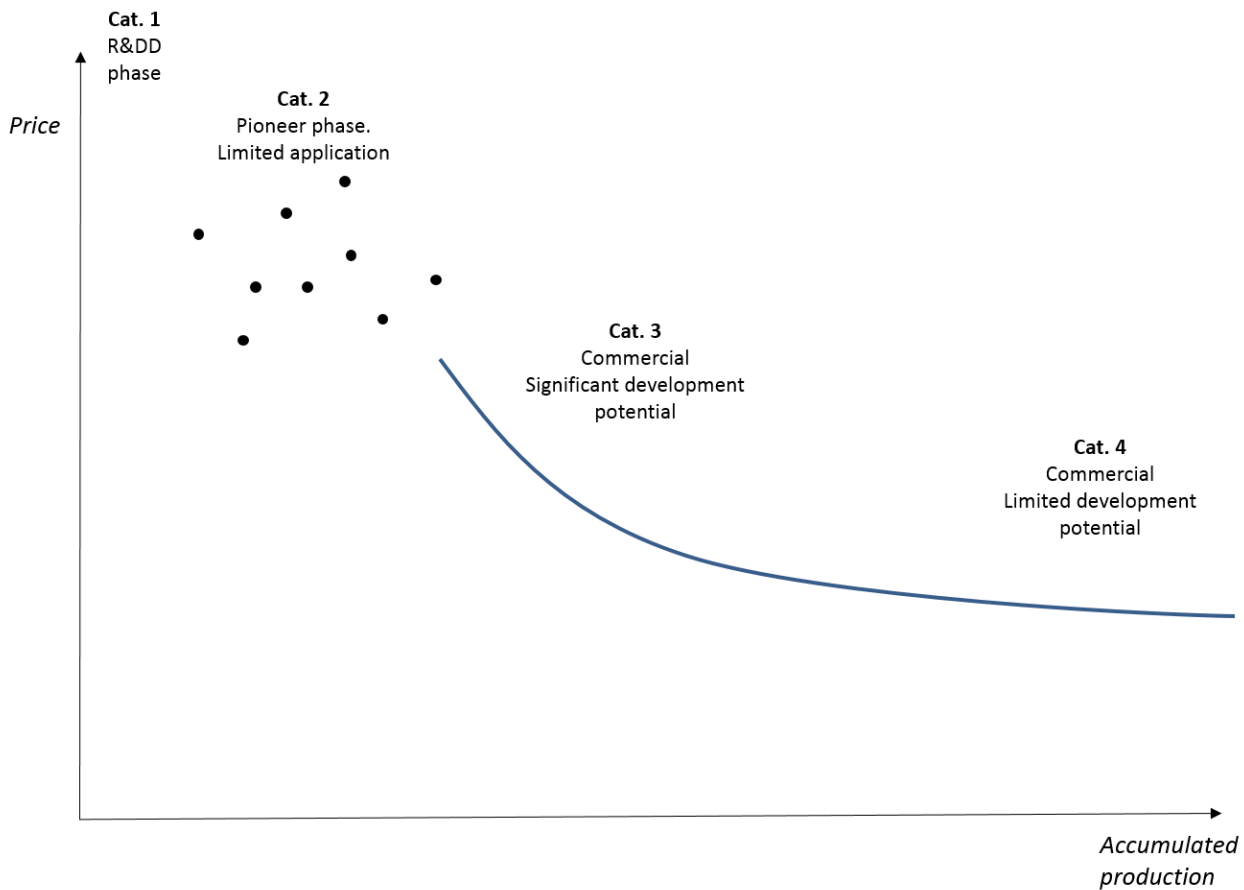

Figure 1: Technological development phases. Correlation between accumulated production volume (MW) and price.

Uncertainty

The catalogue covers both mature technologies and technologies under development. This implies that the price and performance of some technologies may be estimated with a relatively high level of certainty whereas in the case of others, both cost and performance today as well as in the future are associated with high levels of uncertainty.

This section of the technology chapters explains the main challenges to precision of the data and identifies the areas on which the uncertainty ranges in the quantitative description are based. This includes technological or market related issues of the specific technology as well as the level of experience and knowledge in the sector and possible limitations on raw materials. The issues should also relate to the technological development maturity as discussed above.

The level of uncertainty is illustrated by providing a lower and higher bound beside the central estimate, which shall be interpreted as representing probabilities corresponding to a 90% confidence interval. It should be noted, that projecting costs of technologies far into the future is a task associated with very large uncertainties. Thus, depending on the technological maturity expressed and the period considered, the confidence interval

may be very large. It is the case, for example, of less developed technologies (category 1 and 2) and long time horizons (2050).

Additional remarks

This section includes other information, for example links to web sites that describe the technology further or give key figures on it.

References

References are numbered in the text in squared brackets and bibliographical details are listed in this section.

1.3. Quantitative description

To enable comparative analyses between different technologies it is imperative that data are actually comparable: All cost data are stated in fixed 2015 prices excluding value added taxes (VAT) and other taxes. The information given in the tables relate to the development status of the technology at the point of final investment decision (FID) in the given year (2015, 2020, 2030 and 2050). FID is assumed to be taken when financing of a project is secured and all permits are at hand. The year of commissioning will depend on the construction time of the individual technologies.

A typical table of quantitative data is shown below, containing all parameters used to describe the specific technologies. The table consists of a generic part, which is identical for groups of similar technologies (thermal power plants, non-thermal power plants and heat generation technologies) and a technology specific part, containing information, which is only relevant for the specific technology. The generic part is made to allow for easy comparison of technologies.

Each cell in the table contains only one number, which is the central estimate for the market standard technology, i.e. no range indications.

Uncertainties related to the figures are stated in the columns named *uncertainty*. To keep the table simple, the level of uncertainty is only specified for years 2020 and 2050.

The level of uncertainty is illustrated by providing a lower and higher bound. These are chosen to reflect the uncertainties of the best projections by the authors. The section on uncertainty in the qualitative description for each technology indicates the main issues influencing the uncertainty related to the specific technology. For technologies in the early stages of technological development or technologies especially prone to variations of cost and performance data, the bounds expressing the confidence interval could result in large intervals. The uncertainty only applies to the market standard technology; in other words, the uncertainty interval does not represent the product range (for example a product with lower efficiency at a lower price or vice versa).

The level of uncertainty is stated for the most critical figures such as investment cost and efficiencies. Other figures are considered if relevant.

All data in the tables are referenced by a number in the utmost right column (Ref), referring to source specifics below the table. The following separators are used:

; (semicolon) separation between the four time horizons (2015, 2020, 2030, and 2050)

/ (forward slash) separation between sources with different data

+ (plus) agreement between sources on same data

Notes include additional information on how the data are obtained, as well as assumptions and potential calculations behind the figures presented. Before using the data, please be aware that essential information may be found in the notes below the table.

The generic parts of the tables for thermal power plants, non-thermal power plants and heat generation technologies are presented below:

Technology	Thermal elec. generation CHP or ELEC only									
	2015	2020	2030	2050	Uncertainty (2020)		Uncertainty (2050)		Note	Ref
Energy/technical data					Lower	Upper	Lower	Upper		
Generating capacity for one unit (MW)										
Electricity efficiency (condensation mode for extraction plants), net (%), name plate										
Electricity efficiency (condensation mode for extraction plants), net (%), annual average										
Cb coefficient (50°C/100°C)										
Cv coefficient (50°C/100°C)										
Forced outage (%)										
Planned outage (weeks per year)										
Technical lifetime (years)										
Construction time (years)										
Regulation ability										
Primary regulation (% per 30 seconds)										
Secondary regulation (% per minute)										
Minimum load (% of full load)										
Warm start-up time (hours)										
Cold start-up time (hours)										
Environment										
SO ₂ (degree of desulphuring, %)										
NO _x (g per GJ fuel)										
CH ₄ (g per GJ fuel)										
N ₂ O (g per GJ fuel)										
Financial data										
Specific investment (M€/MW)										

- of which equipment										
- of which installation										
Fixed O&M (€/MW/year)										
Variable O&M (€/MWh)										
Startup cost (€/MW/startup)										

Technology	Non-thermal electricity generation									
	2015	2020	2030	2050	Uncertainty (2020)		Uncertainty (2050)		Note	Ref
Energy/technical data					Lower	Upper	Lower	Upper		
Generating capacity for one unit (MW)										
Average annual full-load hours										
Forced outage (%)										
Planned outage (weeks per year)										
Technical lifetime (years)										
Regulation ability										
Primary regulation (% per 30 seconds)										
Secondary regulation (% per minute)										
Financial data										
Specific investment (M€/MW)										
- of which equipment										
- of which installation										
Fixed O&M (€/MW/year)										
Variable O&M (€/MWh)										

Technology	Heat only generation tech (boilers, heat pumps, geothermal)									
	2015	2020	2030	2050	Uncertainty (2020)		Uncertainty (2050)		Note	Ref
Energy/technical data					Lower	Upper	Lower	Upper		
Heat generation capacity for one unit (MW)										
Total efficiency, net (%), name plate										
Total efficiency , net (%), annual average										
Auxiliary electricity consumption (% of heat gen)										
Forced outage (%)										
Planned outage (weeks per year)										
Technical lifetime (years)										
Construction time (years)										
Regulation ability										
Primary regulation (% per 30 seconds)										
Secondary regulation (% per minute)										
Minimum load (% of full load)										
Warm start-up time (hours)										
Cold start-up time (hours)										
Environment										
SO ₂ (g per GJ fuel)										
NO _x (g per GJ fuel)										
CH ₄ (g per GJ fuel)										
N ₂ O (g per GJ fuel)										
Financial data										
Specific investment (M€ per MW)										
- of which equipment										
- of which installation										
Fixed O&M (€/MW/year)										
Variable O&M (€/MWh)										
Startup cost (€/MW/startup)										

Energy/technical data

Generating capacity for one unit

The capacity, preferably a typical capacity (not maximum capacity), is stated for a single unit, capable of producing energy e.g. a single wind turbine (not a wind farm), or a single gas turbine (not a power plant consisting of multiple gas turbines).

In the case of a modular technology such PV or solar heating, a typical size of a solar power plant based on the historical installations or the market standard is chosen as a unit. Different sizes may be specified in separated tables, e.g. Small PV, Medium PV, Large PV.

The capacity is given as net generation capacity in continuous operation, i.e. gross capacity (output from generator) minus own consumption (house load), equal to capacity delivered to the grid. For heat only technologies, any auxiliary electricity consumption for pumps etc. is not counted in the capacity. For combined heat and power generation, only the electric capacity is stated. For extraction plants, the capacity is stated in condensation mode.

The unit MW is used both for electric generation capacity and heat production capacity. While this is not in accordance with thermodynamic formalism, it makes comparisons easier and provides a more intuitive link between capacities, production and full load hours.

The relevant range of sizes of each type of technology is represented by a range of capacities stated in the notes for the “capacity” field in each technology table, for example 200-1000 MW for a new coal-fired power plant.

It should be stressed that data in the table is based on the typical capacity, for example 600 MW for a coal-fired power plant. When deviations from the typical capacity are made, economy of scale effects need to be considered inside the range of typical sizes (see the section about investment cost). The capacity range should be stated in the notes.

Energy efficiencies

Efficiencies for all thermal plants (both electric, heat and combined heat and power) are expressed in percent at lower calorific heat value (lower heating value) at ambient conditions in Denmark, considering an average air temperature of approximately 8 °C.

The electric efficiency of thermal power plants equals the total delivery of electricity to the grid divided by the fuel consumption. Two efficiencies are stated: the nameplate efficiency as stated by the supplier and the expected typical annual efficiency. Total efficiency of thermal power plants can be calculated as described in the formulas of the Annex in the previous catalogue for energy plants available from the Danish Energy Agency’s web site.

For extraction plants, the electric efficiency is stated in condensation mode.

For heat only technologies, the total efficiency equals the heat delivered to the district heating grid divided by the fuel consumption. The auxiliary electricity consumption is not included in the efficiency, but stated separately in percentage of heat generation capacity (i.e. MW auxiliary/MW heat).

The energy supplied by the heat source for heat pumps (both electric and absorption) is not counted as input energy. The temperatures of the heat source are specified in the specific technology chapters.

The expected typical annual efficiency takes into account a typical number of start-ups and shut-downs and is based on the assumed full load hours stated in the introduction (table 1). Regarding the assumed number of start-ups for different technologies, an indication is given in the financial data description, under start-up costs.

Often, the electrical efficiency decreases slightly during the operating life of a thermal power plant. This degradation is not reflected in the stated data. As a rule of thumb 2.5 – 3.5 % may be subtracted during the lifetime (e.g. from 40 % to 37 %). Specific data are given in [3].

Some combined heat and power plants and heat producing boilers are equipped with flue gas condensation equipment, a process whereby the flue gas is cooled below its water dew point and the heat released by the resulting condensation of water is recovered as low temperature heat. In these cases, the stated efficiencies include the added efficiency of the flue gas condensation equipment.

If a combined heat and power plant is equipped with a turbine bypass enabling the plant to produce only heat – for example during periods with low electricity prices – this is mentioned in a note. Per default, it is assumed that the heat efficiency equals the plant's total efficiency when the turbine bypass is applied. Moreover, it is assumed that in by-pass mode the heat capacity corresponds to the sum of the heat and electrical capacities in back-pressure mode.

In a Danish context, seawater is normally used for cooling/condensation, when there is a surplus of heat generation from a CHP plant. Therefore, cooling towers are not considered, for the CHP plant in this catalogue.

The energy efficiency for intermittent technologies (e.g. PV and wind) is expressed as capacity factor. The capacity factor is calculated as the annual production divided by the maximum potential annual production. The maximum potential annual production is calculated assuming the plant has been operating at full load for the entire year, i.e. 8760 hours /year.

Auxiliary electricity consumption

For heat-only technologies the consumption of electricity for auxiliary equipment such as pumps, ventilation systems, etc. is stated separately in percentage of heat generation capacity (i.e. MW auxiliary/MW heat).

For heat pumps, internal consumption is considered part of the efficiency (coefficient of performance, COP), while other electricity demand for external pumping, e.g. ground water pumping, is stated under auxiliary electricity consumption.

For CHP generation, auxiliary consumption is not stated separately but included in the net efficiency and for non-thermal plants, as a reduction in the number of full load hours.

Cogeneration values

The C_b -coefficient (backpressure coefficient) is defined as the maximum power generation capacity in backpressure mode divided by the maximum heat production capacity (including flue gas condensation if applicable).

The C_v -value for an extraction steam turbine is defined as the loss of electricity production, when the heat production is increased one unit at constant fuel input.

Values for C_b and C_v are given – unless otherwise stated – at 100 °C forward temperature and 50 °C return temperature, corresponding to heat delivered to district heating transmission systems. For technologies where delivery to district heating distribution systems are more relevant a temperature set of 80/40 °C may also be used, and this is stated in the data sheet.

Average annual full load hours

The average annual capacity factor mentioned above describes the average annual net generation divided by the theoretical maximum annual net generation if the plant were operating at full capacity for 8760 hours per year. The equivalent full load hours per year is determined by multiplying the capacity factor by 8760 hours, the total number of hours in a year.

The full load hours for non-thermal technologies represent the expected production considering planned and forced outage and auxiliary consumption, if any.

Full load hours vary largely depending on the location and the technology choice. The value stated refers to the Danish context, in an average location and with market standard technology.

Forced and planned outage

Forced outage is defined as the number of weighted forced outage hours divided by the sum of forced outage hours and operation hours. The weighted forced outage hours are the sum of hours of reduced production caused by unplanned outages, weighted according to how much capacity was out.

Forced outage is given in percent, while planned outage (for example due to renovations) is given in days per year.

Technical lifetime

The technical lifetime is the expected time for which an energy plant can be operated within, or acceptably close to, its original performance specifications, provided that normal operation and maintenance takes place. During this lifetime, some performance parameters may degrade gradually but still stay within acceptable limits. For instance, power plant efficiencies often decrease slightly (few percent) over the years, and O&M costs increase due to wear and degradation of components and systems. At the end of the technical lifetime, the frequency of unforeseen operational problems and risk of breakdowns is expected to lead to unacceptably

low availability and/or high O&M costs. At this time, the plant is decommissioned or undergoes a lifetime extension, which implies a major renovation of components and systems as required to make the plant suitable for a new period of continued operation.

The technical lifetime stated in this catalogue is a theoretical value inherent to each technology, based on experience. As stated earlier, the thermal technologies producing electricity and/or heat are in general assumed to be designed for operated for approximately 4,000-5,000 full loads hours annually. The expected technical lifetime takes into account a typical number of start-ups and shut-downs (an indication of the number of start-ups and shut-downs is given in the Financial data description, under Start-up costs).

In real life, specific plants of similar technology may operate for shorter or longer times. The strategy for operation and maintenance, e.g. the number of operation hours, start-ups, and the reinvestments made over the years, will largely influence the actual lifetime.

Construction time

Time from final investment decision (FID) until commissioning completed (start of commercial operation), expressed in years.

Regulation ability

Five parameters describe the electricity regulation capability of the technologies:

- A. Primary regulation (% per 30 seconds): frequency control
- B. Secondary regulation (% per minute): balancing power
- C. Minimum load (percent of full load).
- D. Warm start-up time, (hours)
- E. Cold start-up time, (hours)

For several technologies, these parameters are not relevant, e.g. if the technology is regulated instantly in on/off-mode.

Parameters A and B are spinning reserves; i.e. the ability to regulate when the technology is already in operation.

Parameter D. The warm start-up time used for boiler technologies is defined as the time it takes to reach operating temperatures and pressure and start production from a state where the water temperature in the evaporator is above 100°C, which means that the boiler is pressurized.

Parameter E. The cold start-up time used for boiler technologies is defined as the time it takes to reach operating temperature and pressure and start production from a state where the boiler is at ambient temperature and pressure.

Environment

All plants are assumed to be designed to comply with the regulation that is currently in place in Denmark and planned to be implemented within the 2020 time horizon.

The emissions below are stated in mass per GJ of fuel at the lower heating value.

CO₂ emission values are not stated, as these depend only on the fuel, not the technology.

SO_x emissions are calculated based on the following sulfur contents of fuels:

	Coal	Ori- mulsion	Fuel oil	Gas oil	Natural gas	Peat	Straw	Wood- fuel	Waste	Biogas
Sulphur, kg/GJ	0.27	0.99	0.25	0.07	0.00	0.24	0.20	0.00	0.27	0.00

For technologies, where desulphurization equipment is employed (typically large power plants), the degree of desulphurization is stated in percent.

NO_x . NO_x equals NO₂ + NO, where NO is converted to NO₂ in weight-equivalents.

Greenhouse gas emissions include CH₄ and N₂O in grams per GJ fuel.

Particles includes the fine particle matters (PM 2.5). The value is given in grams per GJ of fuel.

Financial data

Financial data are all in Euro (€), fixed prices, at the 2015-level and exclude value added taxes (VAT) and other taxes.

Several data originate in Danish references. For those data a fixed exchange ratio of 7.45 DKK per € has been used.

The previous catalogue was in 2011 prices. Some data have been updated by applying the general inflation rate in Denmark (2011 prices have been multiplied by 1.0585 to reach the 2015 price level).

European data, with a particular focus on Danish sources, have been emphasized in developing this catalogue. This is done as generalizations of costs of energy technologies has been found to be impossible above the regional or local levels, as per IEA reporting from 2015 [4]. For renewable energy technologies this effect is even stronger as the costs are widely determined by local conditions.

Investment costs

The investment cost is also called the engineering, procurement and construction (EPC) price or the overnight cost. Infrastructure and connection costs, i.e. electricity, fuel and water connections inside the premises of a plant, are also included.

The investment cost is reported on a normalized basis, i.e. cost per MW. The specific investment cost is the total investment cost divided by the capacity stated in the table, i.e. the capacity as seen from the grid, whether electricity or district heat. For electricity generating technologies, incl. combined heat and power generation, the denominator is the electric capacity.

The investment cost of extraction steam turbines, which can be operated in condensation mode, is stated as cost per MW-condensation mode capacity.

Where possible, the investment cost is divided on equipment cost and installation cost. Equipment cost covers the components and machinery including environmental facilities, whereas installation cost covers engineering, civil works, buildings, grid connection, installation and commissioning of equipment.

The rent of land is not included but may be assessed based on the space requirements, if specified in the qualitative description.

The owners' predevelopment costs (administration, consultancy, project management, site preparation, approvals by authorities) and interest during construction are not included. The costs to dismantle decommissioned plants are also not included. Decommissioning costs may be offset by the residual value of the assets.

Cost of grid expansion

The costs of grid expansion from adding a new electricity generator or a new large consumer (e.g. an electric boiler or heat pump) to the grid are not included in the presented data.

The most important costs are related to strengthening or expansion of the local grid and/or substations (voltage transformation, pumping or compression/expansion). The costs vary significantly depending on the type and size of generator and local conditions. For planning purposes, a generic cost of 0.14 M€2015 may be added to the stated investment costs per MW the grid needs be strengthened. This is due for a single expansion. If more generators (or consumers) are connected at the same time, the aggregated capacity addition may be smaller than the sum of the individual expansions, since peak-loads do not occur simultaneously.

Business cycles

The cost of energy equipment shows fluctuations that can be related to business cycles. This was the case of the period 2007-2008 for example, where costs of many energy generation technologies surged dramatically. The trend was general and global. An example is combined cycle gas turbines (CCGT), for which prices increased sharply from \$400-600 per kW to peaks of \$1250. When projecting the costs of technologies, it is attempted to compensate, as far as possible, for the effect of any business cycles, that may influence the current prices.

Economy of scale

The main idea of the catalogue is to provide technical and economic figures for particular sizes of plants. Where plant sizes vary in a large range, different sizes are defined and separate technology chapters are developed.

For assessment of data for plant sizes not included in the catalogue, some general rules should be applied with caution to the scaling of plants.

The cost of one unit for larger power plants is usually less than that for smaller plants. This is called the 'economy of scale'. The basic equation [2] is:

$$\frac{C_1}{C_2} = \left(\frac{P_1}{P_2}\right)^a$$

Where: C_1 = Investment cost of plant 1 (e.g. in million EUR)

C_2 = Investment cost of plant 2

P_1 = Power generation capacity of plant 1 (e.g. in MW)

P_2 = Power generation capacity of plant 2

a = Proportionality factor

Usually, the proportionality factor is about 0.6 – 0.7, but extended project schedules may cause the factor to increase. It is important, however, that the plants are essentially identical in construction technique, design, and construction time frame and that the only significant difference is in size.

The relevant ranges where the economy of scale correction applies are stated in the notes for the capacity field of each technology table. The stated range represents typical capacity ranges.

Large-scale plants, such as coal and nuclear power plants, seems to have reached a size limit, as few investors are willing to add increments of 1000 MW or above. Instead of the scaling effect, multiple unit configurations may provide savings by allowing sharing of balance of plant equipment and support infrastructure. Typically, about 15 % savings in investment cost per MW can be achieved for combined cycle gas turbines and big steam power plants from a twin unit arrangement versus a single unit [3].

Operation and maintenance (O&M) costs

The fixed share of O&M is calculated as cost per generating capacity per year (€/MW/year), where the generating capacity is the one defined at the beginning of this chapter and stated in the tables. It includes all costs, which are independent of how many hours the plant is operated, e.g. administration, operational staff, payments for O&M service agreements, network or system charges, property tax, and insurance. Any necessary reinvestments to keep the plant operating within the technical lifetime are also included, whereas reinvestments to extend the life are excluded. Reinvestments are discounted at 4 % annual discount rate in real terms. The cost of reinvestments to extend the lifetime of the plants may be mentioned in a note if data are available.

The variable O&M costs (€/MWh) include consumption of auxiliary materials (water, lubricants, fuel additives), treatment and disposal of residuals, spare parts and output related repair and maintenance (however not costs covered by guarantees and insurances).

Planned and unplanned maintenance costs may fall under fixed costs (e.g. scheduled yearly maintenance works) or variable costs (e.g. works depending on actual operating time), and are split accordingly.

Fuel costs are not included.

Auxiliary electricity consumption is included for heat only technologies. The electricity price applied is specified in the notes for each technology, together with the share of O&M costs due to auxiliary consumption. This enables corrections from the users with own electricity price figures. The electricity price does not include taxes and PSO.

It should be noticed that O&M costs often develop over time. The stated O&M costs are therefore average costs during the entire lifetime.

Start-up costs

The O&M costs stated in this catalogue includes start-up costs and takes into account a typical number of start-ups and shut-downs. Therefore, the start-up costs should not be specifically included in more general analyses. They should only be used in detailed dynamic analyses of the hour-by-hour load of the technology.

Start-up costs, are stated in costs per MW of generating capacity per start up (€/MW/startup), if relevant. They reflect the direct and indirect costs during a start-up and the subsequent shut down.

The direct start-up costs include fuel consumption, e.g. fuel which is required for heating up boilers and which does not yield usable energy, electricity consumption, and variable O&M costs corresponding to full load during the start-up period.

The indirect costs include the theoretical value loss corresponding to the lifetime reduction for one start up. For instance, during the heating-up, thermal and pressure variations will cause fatigue damage to components, and corrosion may increase in some areas due to e.g. condensation.

An assumption regarding the typical amount of start-ups is made for each technology in order to calculate the O&M costs. This assumption is specified in the notes. The following table shows the assumed number of start-ups per year included in the O&M costs for some technologies.

	Assumed number of start-ups per year
Coal CHP	15
Natural gas CHP (except gas engines)	30
Gas Engines	100
Wood pellet CHP	15
Heat only boilers	50
Municipal solid-waste / biogas stand alone	5
Geothermal heat	5
Heat pumps	30

Electric boilers	100
------------------	-----

The stated O&M costs may be corrected to represent a different number of start-ups than the one presented in the table by using the stated start-up costs with the following formula:

$$O\&M_{new} = O\&M_{old} - (Startup\ cost * n_{startup}^{old}) + (Startup\ cost * n_{startup}^{new})$$

where $n_{startup}^{old}$ is the number of start-ups specified in the notes for the specific technology and $n_{startup}^{new}$ is the desired number of start-ups.

Technology specific data

Additional data is specified in this section, depending on the technology.

Definitions

The steam process in a CHP (co-generation of heat and power) plant can be of different types:

1. **Condensation:** All steam flows all the way through the steam turbine and is fed into a condenser, which is cooled by water at ambient temperature. A condensing steam turbine produces only electricity, no heat.
2. **Back-pressure:** All steam flows all the way through the steam turbine and is fed into a condenser, which is cooled by the return stream from a district heating network or an industrial process heating network. The condensation takes place at elevated temperatures enabling utilization of the produced heat. A back-pressure turbine produces electricity and heat, at an almost constant ratio.
3. **Extraction:** Works in the same way as condensation, but steam can be extracted from the turbine to produce heat (equivalent to back-pressure). This enables flexible operation where the electricity to heat ratio may be varied.

References

Numerous reference documents are mentioned in each of the technology chapters. The references mentioned below are for Chapter 1 only.

- [1] Forudsætninger for samfundsøkonomiske analyser på energiområdet (Generic data to be used for socio-economic analyses in the energy sector), Danish Energy Agency, May 2009.
- [2] Economy of Scale in Power Plants, August 1977 issue of Power Engineering Magazine.
- [3] Projected Costs of Generating Electricity, International Energy Agency, 2010.
- [4] Projected Costs of Generating Electricity, International Energy Agency, 2015.
- [5] Konvergensprogram Danmark 2015, Social- og Indenrigsministeriet, March 2015.
- [6] Energy Technology Perspectives, International Energy Agency, 2012.
- [7] International Energy Agency. Available at: <http://www.iea.org/>. Accessed: 11/03/2016.

01 Supercritical Pulverized Fuel Power Plant

This chapter has been moved here from the previous Technology Data Catalogue for Electricity and district heating production from May 2012. Therefore, the text and data sheets do not follow the same guidelines as the remainder of the catalogue.

Contact information:

Danish Energy Agency: Rikke Næraa, rin@ens.dk

Author: Ea Energy Analyses

Publication date

May 2012

Amendments after publication date

Date	Ref.	Description
October 2018	01 Supercritical Pulverized Fuel Power Plant	Section for prediction of performance and costs added
November 2017	01 Supercritical Pulverized Fuel Power Plant	Datasheet for Supercritical Pulverized Fuel Power Plant - Coal CHP included

Brief technology description

Large base-load units with pulverised fuel (PF) combustion and advanced (supercritical) steam data.

Supercritical steam data are above 240-260 bar and 560-570 °C. The term ‘ultra-supercritical’ has been used (e.g. by ref. 4) for plants with steam temperatures of approximately 580 °C and above. Advanced data (AD) goes up to 350 bar and 700 °C (ref. 3). The advanced steam cycle includes up to ten pre- heaters and double re-heating.

The AD plants obtain higher efficiencies, both the electricity efficiency in condensing mode and the total energy efficiency in backpressure mode. The higher efficiencies are obtained in full load mode as well as part load and the high efficiencies remain even after many years of operation.

The integrated coal gasification combined-cycle (IGCC) plants are a fundamentally different coal technology, expected to achieve efficiencies above 50% in demonstration projects before year 2020 (ref. 4). Data for this technology are not presented below, since the AD technology appears to have better performance data.

Input

The process is primarily based on coal, but will be applicable to other fuels such as wood pellets and natural gas.

Output

Power and possibly heat.

The auxiliary power need for a 500 MW plant is 40-45 MW, and the net electricity efficiency is thus 3.7-4.3 percentage points lower than the gross efficiency (ref. 3).

Typical capacities

AD plants are built in capacities from 400 MW to 1000 MW.

Regulation ability

Pulverized fuel power plants are able to deliver both primary load support (frequency control) and secondary load support.

The units are in general able to deliver 5% of their rated capacity as primary load support within 30 seconds at loads between 50% and 90%. This fast load control is achieved by utilizing certain water/steam buffers within the unit. The secondary load control takes over after approximately 5 minutes, when the primary load control has utilized its water/steam buffers. The secondary load control is able to sustain the 5% load rise achieved by the primary load control and even further to increase the load (if not already at maximum load) by running up the boiler load.

Negative load changes can also be achieved by by-passing steam (past the turbine) or by closure of the turbine steam valves and subsequent reduction of boiler load.

A secondary regulation ability of 4% per minute is achievable between approximately 50% and 90% load on a pulverized fuel fired unit. The unit will respond slower below 50% and above 90%, approximately at 2% per minute (ref. 5).

Advantages/disadvantages

The efficiencies are not reduced as significantly at part load compared to full load as with CC-plants.

Coal fired power plants using the advanced steam cycle possess the same fuel flexibility as the conventional boiler technology. However, AD plants have higher requirements concerning fuel quality. Inexpensive heavy fuel oil cannot be burned due to materials like vanadium, unless the steam temperature (and hence efficiency) is reduced, and biomass fuels may cause corrosion and scaling, if not handled properly.

Environment

The main ecological footprints from coal-fired AD plants are bulk waste (disposal of earth, cinder, and rejects from mining), climate change and acidification. The fly ash can be utilized 100% in cement and concrete.

Research and development

Conventional super critical coal technology is fairly well established and so there appear to be no major breakthroughs ahead. There is very limited scope to improve the cycle thermodynamically. It is more likely that the application of new materials will allow higher efficiencies, though this is unlikely to come at a significantly lower cost (ref. 6).

Best-available-technology plants today operate at up to 600 °C. An electricity efficiency of 55 % requires steam at 700 °C and the use of nickel-based alloys (ref. 2). Further RD&D in such alloy steels is required in order to obtain increased strength, lower costs and thereby cheaper and more flexible plants.

Examples of best available technology

- Avedøre Power Station (Copenhagen), Unit 2; 570 MW; gas fired; steam at turbine inlet 580 °C and 300 bar; pre-coupled gas turbines.
- Nordjylland Power Station, Unit 3; 400 MW, commissioned 1998, coal fired.
- Skærbæk Power Station, Unit 3; 400 MW, gas fired; commissioned 1997.

Prediction of performance and costs

In Denmark, most thermal units are combined heat and power plants (CHP). Most other countries do not have the demand for residential heating to utilize the waste heat from power plants, and are therefore using pure condensing plants. It is assumed that all new coal fired CHP units in Denmark will be extraction units.

The following section follows the steps of (1) analysing the possible differences between CHP and condensing units which could impact the CAPEX and OPEX, then (2) analysing and comparing data of coal fired power plants from different sources. In this connection, OPEX is considered a total of fixed and variable O&M costs. Thereafter (3) an estimation of the split between fixed and variable O&M cost is performed.

The data is based upon the following publications and projects:

1. The IEA World Energy Outlook 2014 coal fired Ultra-supercritical power plants in Europe.
Values used are the projection for 2020.

2. The IEA Projected Cost of Generating Electricity 2015 for coal fired power plants. Here both the ‘world median’ is used, and data from recently commissioned plants in the Netherlands. The three units in the Netherlands are chosen because of the proximity to Denmark, because the socio-economic parameters (labour cost etc) are assumed to be similar and because the units are new (all from 2015).
3. EIA Updated Capital Cost Estimates for Utility Scale Electricity Generating Plants 2013 for pulverizes coal fired advanced single units.¹
4. Aggregated data from different projects on existing units that Ea Energy Analyses have been working on since 2010. Data is used for estimating O&M costs.

All prices in this analysis are in €2015. The cost from each source have been converted to its original value and currency, and then converted to €2015. All specific values are in MW electricity output. Due to economy-of-scale relationships, only larger power plants are considered, i.e. above 400 MW.

	Exchange rate to €2015	Used by source
€2011	1.059	DEA TC 2011
\$2012	0.824	[1]
\$2013	0.767	[2],[3]

Table 1: Exchange rates from currency used in source to €2015.

In the evaluation, European plants are weighted higher than overseas (USA) plants, and newer plants (2015-2020) are weighted higher than older (before 2015). And data from newer sources are weighted higher than older.

Differences between CHP and condensing units

The main difference between a condensing power plant and an extraction CHP plant, is that an extraction plant needs an additional heat exchanger compared to a condensing plant (see Figure 1). This additional district heating heat exchanger utilizes extracted intermedia steam from the turbines. From Danish experiences, the whole district heating installation is only

¹ In the report the costs estimates were based on information derived from actual or planned projects known to the consultant, when possible. When this information was not available, the project costs were estimated using costing models that account for the current labor and materials rates necessary to complete the construction of a generic facility as well as consistent assumptions for the contractual relationship between the project owner and the construction contractor. All costs were weighted average of the sources.

around 5% of the total CAPEX, which suggest only a small increase in the overall cost. There is therefore assumed 5 % higher costs of both CAPEX and OPEX on CHP compared to condensing power plants.

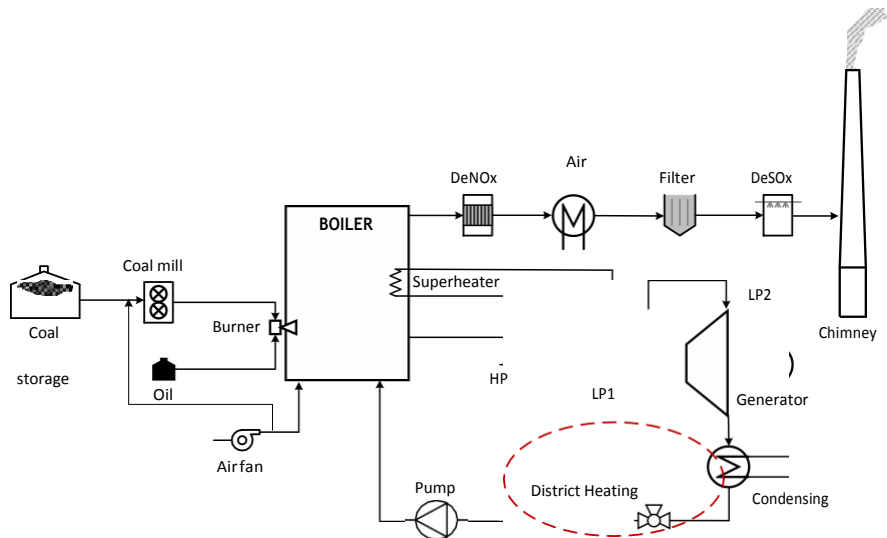

Figure 1: A schematic diagram of an extraction plant.

CAPEX and OPEX cost of new coal fired power plants

All values compared are for new units (year 2020 is chosen when possible – assumed year of commissioning). The specific investment costs for the different sources are plotted in Figure 2 below. The MW is the unit’s full load condensing power capacity. For condensing units, it is assumed that the costs are for a power plant cooling with sea water, which is known to be the case for the three units in the Netherlands.

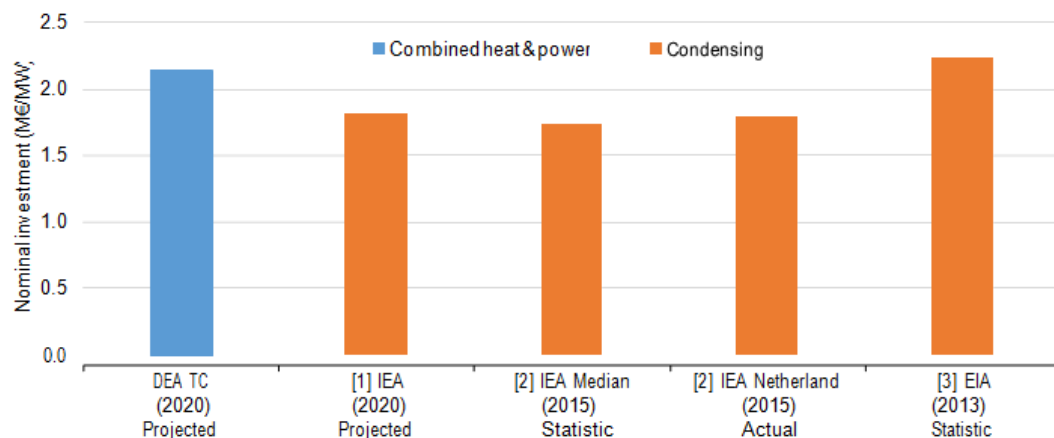

Figure 2: Nominal investment in coal fired power plants (2015M€/MW). The years in () indicate the year of the commission or statistic.

The investment cost from the European sources [1-2] is around 1.8 M€/MW, where the exception is the current value from the Technology Catalogue of 2.15 M€/MW, which is app. 20% higher. The cost listed by EIA for the USA is on the same level as the Technology Catalogue. According to the IEA the price of coal power is around 5 % higher in the USA compared to Europe. Under this assumption the EIA price for the USA can be translated to around 2 M€/MW for a European plant.

Weighting the newest projects and European sources highest, 1.8 M€/MW is proposed as the central estimate for condensing power plants. Assuming a 5% additional investment cost for adding the district heating units, the 1.9 M€/MW for coal fired CHP plants is proposed.

In the data sheet in the Technology Catalogue the OPEX is split into variable and fixed O&M costs. However, it is not always clear when a cost is going from fixed to variable and vice versa, and therefore different sources list O&M cost differently. To be sure that we can directly compare the costs we therefore look at O&M as a yearly sum (see Figure 3). And here used the amount of full load hours that each source assuming². All sources assume a lifetime of 40 years.

² For the current DEA TC and the data from Ea are assumed 4500 hours and for the IEA and EIA sources are assumed 7500 hours.

Most sources project a decrease in the O&M cost for future plants (not shown in the figure), except the data in the current (before June 2017) Technology Catalogue, which surprisingly project an increase over time. The increase in the electrical efficiency over time is further increasing the O&M per input to the boiler, because the costs are given per MW and MWh electricity.

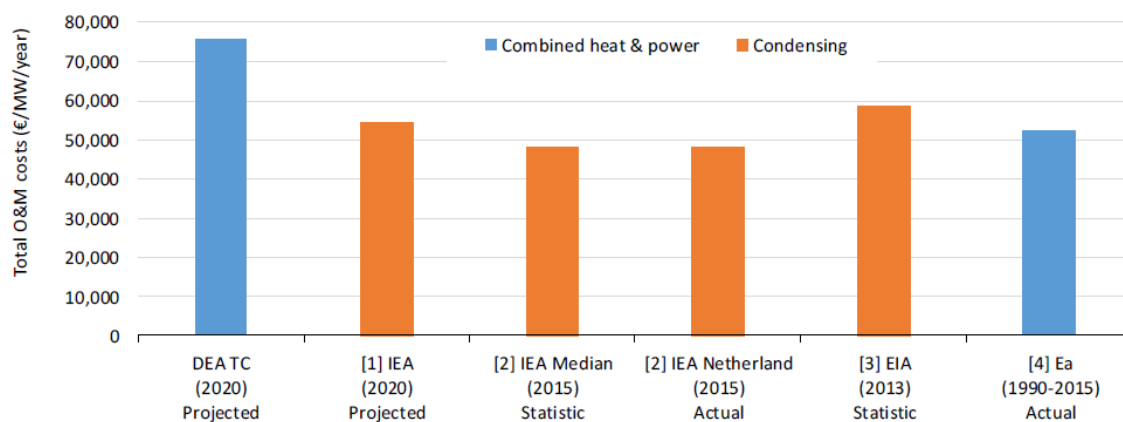

Figure 3: Total annual O&M costs for coal fired power plants (2015€/MW/year). The year in () indicate the year of the projection or statistic.

The current data in the Technology Catalogue again list highest value, which is around 75,000 €/MW/year – i.e. 50% higher compared to the weighted average of the other sources of around 50,000 €/MW/year [1-4]. CHP plants are assumed to have a 5% higher O&M costs due to the extra heat element in the unit. So, the total O&M costs of a coal fired CHP unit are evaluated to be around 52,500 €/MW/year.

Split between variable and fixed O&M cost

As mentioned, it is not always clear when a cost is going from fixed to variable and vice versa. To evaluate the split, variable costs from the sources that list these are used (see Figure 4). The prices seem to be between 2-4 €/MWh.

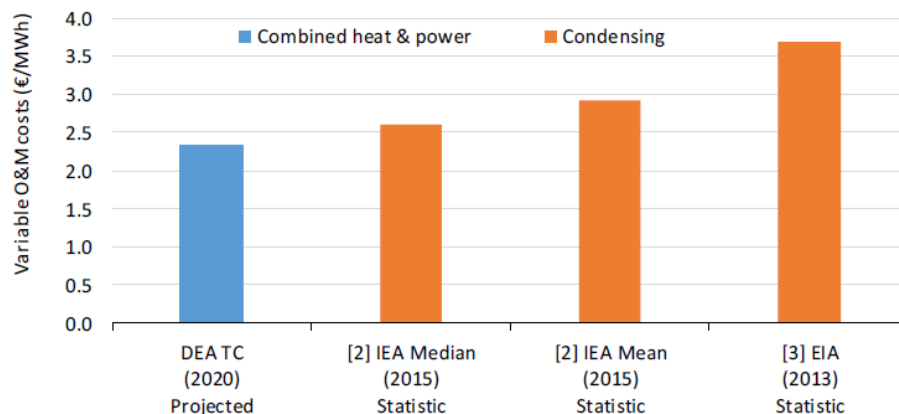

Figure 4: Variable O&M cost (2015€/MWh). The year in () indicate the year of the projection or statistic.

Choosing 2.75 €/MWh as variable O&M cost for a condensing plant (weighting the newer sources highest) and adding 5% for the CHP part gives around 2.9 €/MWh. Using 7500 full load hours as used above, and 52,500 €/MW/year in total O&M costs, this yields a fixed O&M of 31,000 €/MW/year.

Updated financial numbers

The table below summarise the findings and updated financial figures of coal power CHP plants in the Danish Technology Catalogue for commission year 2020. Newer and European data are weighted higher than older data and data from overseas.

Year 2020	Previous catalogue	New financial figures	Difference
Nominal investment (M€/MW)	2.15	1.9	-12%
Fixed O&M (€/MW/year)	65,000	31,000	-52%
Variable O&M (€/MWh)	2.3	2.9	+24%

Note: Data for plant with a max. capacity of 400-1000 MW. The costs are given in relation to the maximum electricity output, e.g. in condensing mode. The fixed and variable O&M are assumed to be independent of the amount of full load hours.

According to the NREL report³ mature power plant costs are generally expected to follow the overall general inflation rate over the long term. And since the suggested prices listed in

³ Black & Veatch for NREL (2012), "Cost and performance data for power generation technologies"

the table are in real 2015 prices, then no, or very little (annually 0% -1%), development is expected.

Prediction of the cost in 2030 and 2050

To predict the costs in 2030 and 2050, it is assumed that the cost is falling by 0.2 % p.a. This is based on an assumption of accumulation of capacity commissioned from 2020 to 2050 deduced from predictions of the future global installed electricity capacity in the 4D scenario in the Energy Technology Perspectives⁴ [IEA,2016], and a assumed learning rate⁵ of app. 8 % for coal technologies.

Additional remarks

The efficiencies shown in the tables below assume the availability of sufficient cooling water at low temperatures (North European oceans).

A steam extraction turbine enables a large degree of freedom in varying the electricity and heat generation. This is shown by the below (ideal) figure:

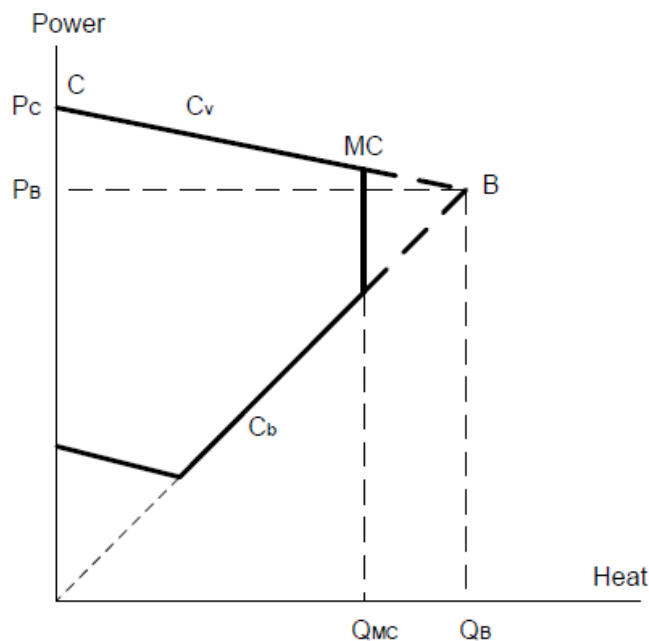

P_c : Power capacity in full condensation mode; point C. No heat production.

$\eta_{E,C}$: Electricity efficiency in full condensation mode.

4 IEA(2016),Energy Technology Perspectives

5 E.S. Rubin et al. / Energy Policy 86 (2015) page 198–218, A review of learning rates for electricity supply technologies

Q_B : Heat capacity in full back-pressure mode (no low-pressure condensation); point B. P_B : Power capacity in full back-pressure mode.
 Q_{MC} : Heat capacity at minimum low-pressure condensation; point MC.
 c_v : Loss of electricity generation per unit of heat generated at fixed fuel input; assumed constant. c_b : Back-pressure coefficient (electricity divided by heat); assumed constant.

The fuel consumption H for any given combination of power generation (P) and heat generation (Q):

$$H = \frac{P + c_v \cdot Q}{\eta_{e,c}}$$

At point MC the efficiencies can be determined by:

$\eta_{e,MC}$: Electricity efficiency at minimum low-pressure condensation:

$$\eta_{e,MC} = \eta_{e,c} \cdot \left\{ 1 - \frac{c_v}{c_b + c_v} \cdot \frac{Q_{MC}}{Q_B} \right\}$$

$\eta_{q,MC}$: Heat efficiency at minimum low-pressure condensation:

$$\eta_{q,MC} = \frac{\eta_{e,c}}{c_b + c_v} \cdot \frac{Q_{MC}}{Q_B}$$

$\eta_{tot,MC}$: Total efficiency (electricity plus heat) at minimum low-pressure condensation:

$$\eta_{tot,MC} = \eta_{e,c} \cdot \left\{ 1 + \frac{1 - c_v}{c_b + c_v} \cdot \frac{Q_{MC}}{Q_B} \right\}$$

In 2009, 3 out of 13 Danish extraction steam turbines had $Q_{MC}/Q_B = 1.0$, the average of all units being 0.80. This excludes a number of extraction steam turbines, which to a large extent were operated as condensation turbines, since the district heating loads were very small.

More details are given in **Annex 1**.

The biggest capital items of a coal plant are boiler, steam turbine and generator, with the boiler alone accounting for over 25% of costs. The civil works component falls around 20%, while the fuel handling is larger item than for most other technologies, except solid fuel biomass. Flue gas desulphurisation (FGD), which once accounted for some 15-20% of

investment cost has fallen over time such that FGD and SCR (selective catalytic reduction of NO_x) together typically account for some 10-15% of investment (ref. 6).

References

1. Elsam's and Elkraft's update of the Danish Energy Authority's technology catalogue (in Danish), 'Teknologidata for el- og varmeproduktionsanlæg', 1997.
2. Elforsk: "El från nya anläggningar", Stockholm, 2000.
3. www.ad700.dk
4. "Energy technology perspectives 2008", International Energy Agency, 2008.
5. DONG Energy, 2009.
6. "UK Electricity Generation Costs Update", Mott MacDonald, June 2010; commissioned by the Department of Energy and Climate Change, United Kingdom.

Datasheet

Technology	Pulverized coal fired, Supercritical steam process, extraction plant					
	2015	2020	2030	2050	Note	Ref
Energy/technical data						
Generating capacity for one unit (MW)	400 - 700					
Electricity efficiency, condensation mode, net (%)	44-48	46-51	52	52-55	C	8;7;9;11
Cb coefficient (50°C/100°C)	0.75	0.84	1.01		A	
Cv coefficient (50°C/100°C)	0.15	0.15	0.15			1
Availability (%)	95	95	95		E	7
Technical lifetime (years)	25	25	25	25		6
Construction time (years)	4.5	4.5	4.5			2;3;3
Environment						
SO ₂ (degree of desulphuring, %)	97	97	97	97	B	5
NO _x (g per GJ fuel)	38	35	35	35	B	12;5;5;5
CH ₄ (g per GJ fuel)	1.5	1.5	1.5	1.5		13;5;5;5
N ₂ O (g per GJ fuel)	0.8	0.8	0.8	0.8		13;5;5;5
Financial data (in 2015€)						
Nominal investment (M€/MW)	1.93	1.9	1.86	1.78	J	17,18,19,20,21,22
Fixed O&M (€/MW/year)	31,500	31,000	30,355	29,105	J	17,18,19,20,21,22
Variable O&M (€/MWh)	3.0	2.9	2.8	2.7	J	17,18,19,20,21,22
Regulation ability						
Primary load support (% per 30 seconds)	5	5	5	5	D	14
Secondary load support (% per minute)	4	4	4	4	D	14
Minimum load (% of full load)	18	15	15	10		10+14

References:

- 1 Elsam, November 2003
- 2 Elsam's and Elkraft's update of the Danish Energy Agency's 'Teknologidata for el- og varmeproduktionsanlæg', December 1997

- 3 Eltra, September 2003
- 5 Danish Energy Agency, 2009.
- 6 "Projected costs of generating electricity", International Energy Agency (IEA), 2005.
- 7 "Energy technology perspectives 2008", International Energy Agency, 2008.
- 8 Danish Energy Agency, 2008. Measured data (1994-2006) from newest power plants in Denmark.
- 9 Own estimate by Danish Energy Agency and Energinet.dk, 2011.
- 10 Energinet.dk, 2009
- 11 www.ad700.dk
- 12 "En opdateret analyse af Danmarks muligheder for at reducere emissionerne af NOx" (Updated analysis of Denmark's options to reduce NOx emissions; in Danish), Danish Environmental Protection Agency, 2009.
- 13 National Environmental Research Institute, Denmark, 2009 (data from 2007).
- 14 DONG Energy, 2009.
- 15 "UK Electricity Generation Costs Update", Mott MacDonald, June 2010.
- 16 "The Costs of CO2 Capture, Transport and Storage", Zero Emissions Platform (ZEP), July 2011
- 17 The IEA World Energy Outlook 2014 coal fired Ultra-supercritical power plants in Europe. Values used are the projection for 2020.
- 18 The IEA Projected Cost of Generating Electricity 2015 for coal fired power plants. Here both the 'world median' is used, and data from recently commissioned plants in the Netherlands. The three units in the Netherlands are chosen because of the proximity to Denmark, because the socio-economic parameters (labour cost etc) are assumed to be similar and because the units are new (all from 2015).
- 19 EIA Updated Capital Cost Estimates for Utility Scale Electricity Generating Plants 2013 for pulverizes coal fired advanced single units.[1]
- 20 Aggregated data from different projects on existing units that Ea Energy Analyses have been working on since 2010. Data is used for estimating O&M costs.
- 21 IEA(2016),Energy Technology Perspectives
- 22 E.S. Rubin et al. / Energy Policy 86 (2015) page 198–218, A review of learning rates for electricity supply technologies

Notes:

- A The C_b values have been calculated from the electricity efficiencies in condensation mode, the C_v values and a total efficiency (electricity plus heat) in full back-pressure mode of 90%. Cf. Annex 1.
- B The data for SO₂ and NO_x emissions assume flue gas desulphurisation (wet gypsum) and DeNO_x equipment of the "high dust" SCR type.
- C Supercritical in 2010 and ultra-supercritical from 2020.
- D Please refer to section 'Regulation ability' in the above qualitative description.
- E Outage rates are generally about 5% for plants that are 10-20 years old. Unless the plant is refurbished, the rate increases to 20% for plants that are 40 years old (ref. 7)
- F It is assumed that the cost is falling by 0.2 % p.a.

02 Life Time Extensions of Coal Power Plants

Contact information:

Danish Energy Agency: Rikke Næraa, rin@ens.dk

Author: Ea Energy Analyses

Publication date

August 2016

Amendments after publication date

Date	Ref.	Description

Qualitative description

Brief technology description

Large coal power plants have been a major source of combined electricity and heat generation in Denmark for the last decades. When a plant has been in operation for 25 years or more, the reliability of its components and systems will likely decrease leading to reduced availability and/or increased O&M costs. Therefore, based on experience, it will usually be necessary and beneficial to carry out a larger package of work that addresses repairs, renovation, and replacement of selected components and systems depending on their actual condition. Often also, improvement of environmental performance may be required, e.g. by improving the flue gas cleaning performance. This 'Life Time Extension' (LTE) is done with the purpose of restoring the plant to come close to its original conditions in terms of availability, efficiency and O&M costs. The exact scope and extent of such a campaign though, shall be tailored to the actual plant in question and will depend on its design, previous records of operation, earlier major works carried out, etc. Also, the expected/desired future operation of the plant is taken into account. Whether or not to extend the life of a power plant is therefore not a simple decision, but involves complex economic and technical factors [1].

In this technology catalogue it is assumed that the life time extension

- takes place after approx. 25 years of normal operation, during which
- the maintenance of the plant has been carried out as planned, and
- enables the plant to be operated with the availability rate close to that of the original new plant
- within the originally expected O&M budget,
- for an extended life time of approx. 15-20 years

It may be convenient to carry out all necessary works in one campaign, to reduce the overall down time, or to distribute the work over several years. For this case it is assumed that all work is done in one campaign. It is expected that the original plant comply with the environmental legislation at the time of the LTE. The costs of bringing it up to date prior to the LTE are therefore not taken into account.

The LTE described here does not take specific measures to increase the efficiency, emissions level standards, or regulation abilities of the plant. Such required or desirable improvements may follow as a consequence without further investments, or may be possible at a reduced investment when major overhauls and component replacements are carried out anyhow.

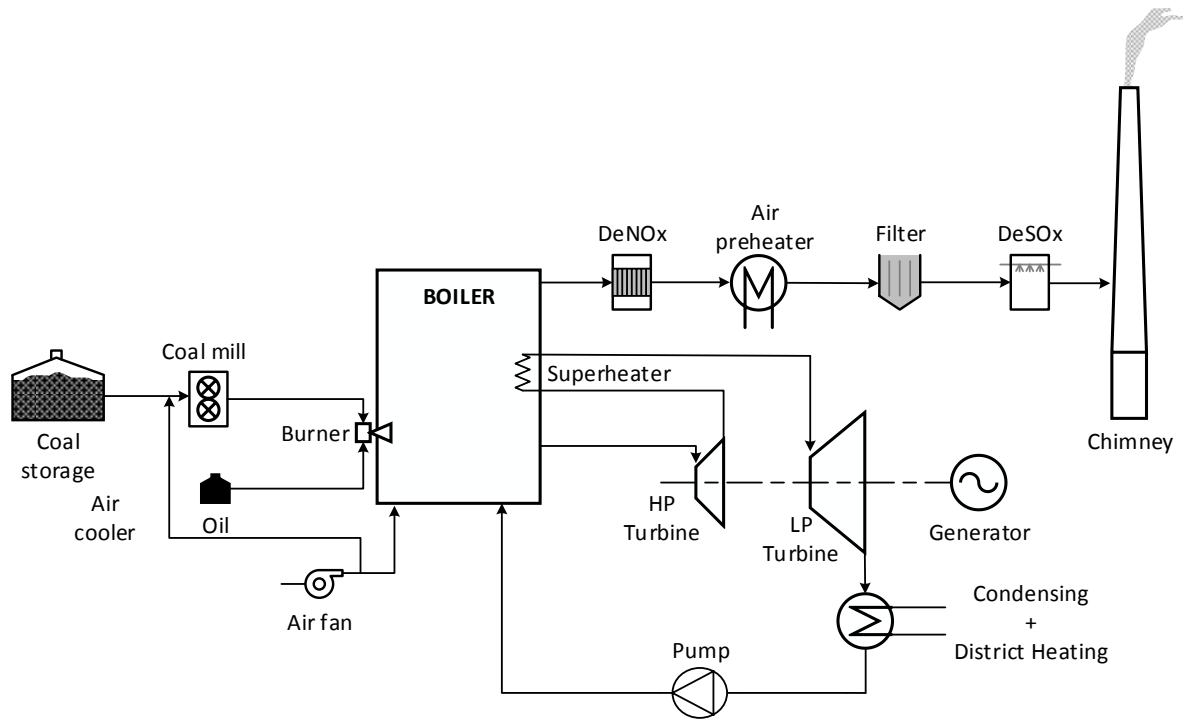

Figure 1: Sketch of the main elements of a large coal fired CHP plant.

In connection with the LTE the plant will be out of operation for a period, typically 6-9 months.

The LTE will typically involve considerable project costs for planning and management since it requires establishing a project organisation for engineering, purchase, construction management, test, and commissioning.

The distribution of works and costs involved with a LTE of an existing coal fired plant could typically be as follows, however depending widely on the actual scope [1]

Main elements can be:

- Revision of electrical systems
- Instrumentation and control systems replacement
- Pulverizers upgrade or replacement (fuel supply and disposal)
- Boiler upgrade,
- Turbine refurbishment (possibly generator refurbishment)
- Water systems (heat exchanges for condensers and district heating)

- Buildings
- Flue gas cleaning.

At top of that, there is a relatively large share of project- and unexpected costs (see figure 2). The basis for deciding which works to include in the LTE is an understanding of the plant’s condition, which can be obtained using diagnostic systems and making a detailed remaining life assessment [2].

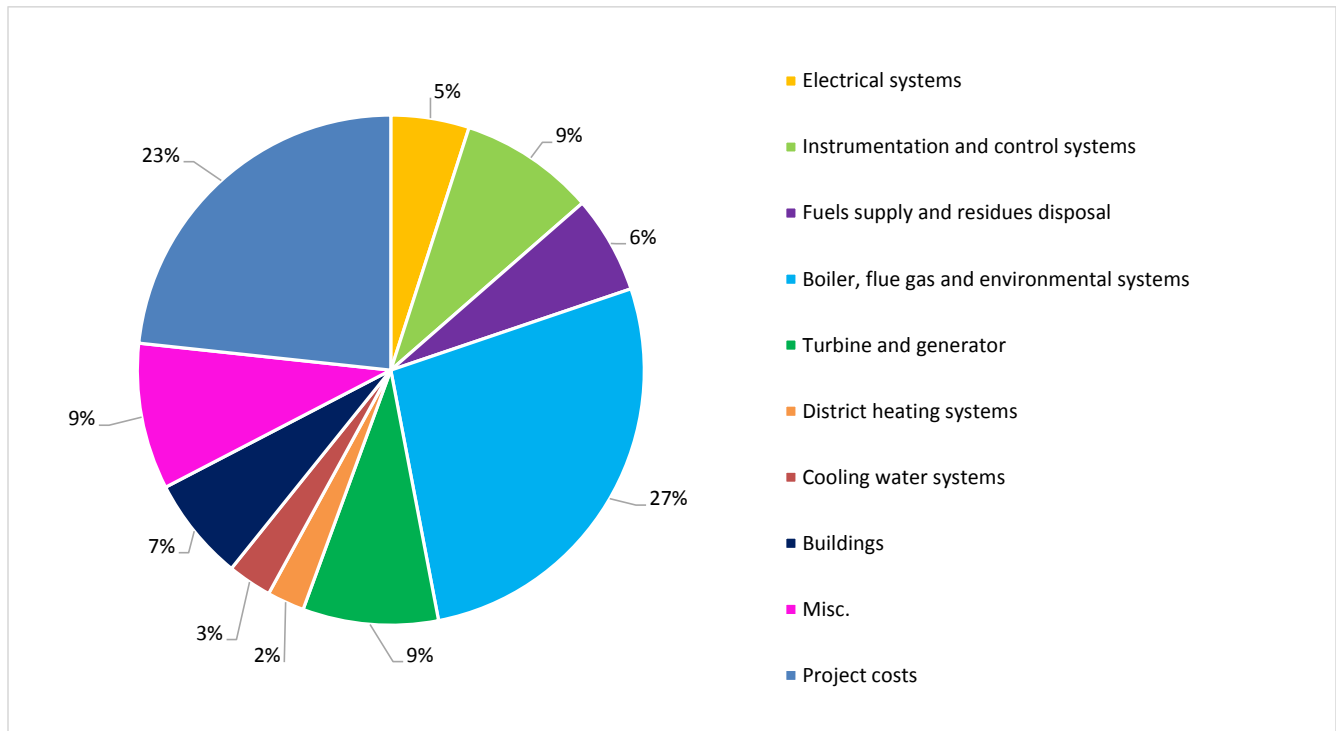

Figure 2: Diagram showing an example of the share of investment cost for an LTE project.

Life time extension of existing plants is also relevant when rebuilding to other fuels e.g. biomass as discussed in chapter 03 on conversion of power plants.

Input

Primary fuels are coal. Oil and/or natural gas are typically used for auxiliary start-up burners.

Output

The output is electricity and possibly heat for use in district heating systems.

Typical capacities

The capacity range considered is 200-400 MW_e.

Space requirement

The space requirements are not considered to change due to LTE.

Regulation ability and other power system services

The regulation abilities of coal fired power plants, e.g. start-up time and ramp rates may improve in connection with LTE due to implementation of better control systems [2]. This effect is, however, not possible to quantify on a general level. In general, start-up times and -costs are not considered to change due to LTE.

Advantages/disadvantages

Advantages

Life time extension of existing large coal fired power plants offers a relatively quick and easy solution to keep existing capacity in operation, since the costs are typically several times lower than investments in new capacity. Typical Danish power plants of age 20-25 years have quite high efficiencies and environmental performance compared with today's standard, so the difference in comparison to a new plant may not be crucial. The overall difference in efficiency compared to a new plant will be 3-5% points.

Disadvantages

One disadvantage is that the original performance data of the plant are difficult to alter significantly. Also, the future operation of coal fired plants is challenged by their environmental effects (especially CO₂ emissions), which may be deemed politically unacceptable on a medium to longer term.

Environment

The lifetime extension is not in itself expected to change the environmental performance characteristics beyond the maximum allowed emission values at the time of LTE, that probably are more stringent than the original requirements. If advantageous or required, such further improvements may be implemented in connection with LTE campaign.

Research and development perspectives

It is not anticipated that there will be a considerable further development in the technology relevant for life time extension of Danish large coal fired power plants. However, with the large number of coal power plants running world-wide, it is expected that LTE methods will generally improve.

Examples of market standard technology

The life time extension (LTE) of DONG Energy's Studstrupværket blok 3, 350 MW, 2012-2013 is one of the most recent Danish examples [3]. There have only been few recent LTE projects in Denmark.

Uncertainty

The investment costs of a LTE presented in the table are connected with relatively large uncertainties. The main reasons for this are the differences among the existing power plants in terms of design, technical condition, previous works carried out, etc. Also, some uncertainty is expected related to general variations of prices and markets in the energy sector, e.g. raw materials like steel and copper, and the supply situation in the construction sector.

Additional remarks

NIL

Data sheets

The following datasheet shows the technical, environmental and financial data for the specific technology. For more explanation, see the section about Quantitative description in the Introduction chapter. The columns “uncertainty” indicates the uncertainty or range of the parameter. The uncertainties only apply to the row, and cannot be read vertically, i.e. the lower uncertainty of the investment cost does not apply to the lower uncertainty of the capacity

Technology	Life time extension of coal power plant, extraction plant									
	2015	2020	2030	2050	Uncertainty (2020)		Uncertainty (2050)		Note	Ref
Energy/technical data					Lower	Upper	Lower	Upper		
Generating capacity for one unit (MW)	300	300	300		200	400	200	400		
Electricity efficiency (condensation mode for extraction plants), net (%), name plate	+0	+0	+0		-1	+1			EF	7
Electricity efficiency (condensation mode for extraction plants), net (%), annual average	+0	+0	+0		-1	+1			EF	7
Cb coefficient (50°C/100°C)	+0	+0	+0		+0	+0			AF	7
Cv coefficient (50°C/100°C)	+0	+0	+0		+0	+0			AF	7
Forced outage (%)	+0	+0	+0		+0	+0			AF	7
Planned outage (weeks per year)	+0	+0	+0		+0	+0			AF	7
Technical lifetime (years)	15	15	15							4, 5, 6, 7
Construction time (years)	0.5	0.5	0.5							7
Space requirement (1000m ² /MW)	+0	+0	+0		+0	+0			AF	
Regulation ability										
Primary regulation (% per 30 seconds)	+0	+0	+0		+0	+0			AF	7
Secondary regulation (% per minute)	+0	+0	+0		+0	+0			AF	7
Minimum load (% of full load)	+0	+0	+0		+0	+0			AF	7
Warm start-up time (hours)	+0	+0	+0		+0	+0			AF	7
Cold start-up time (hours)	+0	+0	+0		+0	+0			AF	7
Environment										
SO ₂ (degree of desulphuring, %)	+0	+0	+0		+0	+0			AFG	8
NO _x (g per GJ fuel)	+0	+0	+0		+0	+0			AFG	8
CH ₄ (g per GJ fuel)	+0	+0	+0		+0	+0			AFG	8
N ₂ O (g per GJ fuel)	+0	+0	+0		+0	+0			AFG	8
Financial data										
Nominal investment (M€/MW)	0.24	0.24	0.24		0.15	0.34			CF	4, 5, 6, 7
- of which equipment	-	-	-		-	-				
- of which installation	-	-	-		-	-				
Fixed O&M (€/MW/year)	+0	+0	+0		+0	+8,000			ABF	7
Variable O&M (€/MWh)	+0	+0	+0		+0	+0			ADF	7

Notes:

- A Values will generally be similar to those of the plant prior to Life Time Extension (LTE).
- B Values will depend on those of the plant prior to LTE, however the average fixed O&M cost may increase slightly for the extension period compared with the original life time to accommodate the necessary reinvestments during the extended life time.
- C Investment costs will vary largely, depending on the necessary scope of work. The indicated range represents typical cases where 20-25 years Danish coal power CHP plants have been life time extended to obtain additional 15 years life time (based mainly on budgetted values).

- D Variable O&M costs will in general be similar or a bit smaller to those of the plant prior to LTE. The reason for the small improvement is when you compare it to just before the LTE. When compared to the average over the lifetime the O&M costs will be similar.
- E Values will generally be similar to those of the plant prior to LTE. Average efficiencies over the lifetime will be similar to the plant prior to LTE, but the efficiencies just after the LTE will be better than that of the plant just before the LTE.
- F Values for year 2050 are not considered relevant since new coal fired power plants are not expected to be built
- G It is assumed that plant emissions prior to the LTE are within the legal limits.

References

- [1] Electricity Generation Costs, Department of Energy and Climate Change (UK), Dec 2013 [Online]. Available: https://www.gov.uk/government/uploads/system/uploads/attachment_data/file/269888/131217_Electricity_Generation_costs_report_December_2013_Final.pdf.
- [2] R. Ambrosini, Life extension of coal-fired power plants, IEA, Dec 2005.
- [3] AFTALE MELLEM DONG Energy Power A/S OG Aarhus Kommune VEDR. Betaling af omkostninger til levetidsforlængelse af Studstrupværkets produktionsblok 3 og fællesanlæg, Århus Kommune, April 2012. [Online]. Available: <http://www.aarhus.dk/~media/eDoc/C/1/2/C125711F0048D96EC12579C1004C66F3attach2.pdf>
- [4] Projected Costs of Generating electricity edition 2015, IEA, NEA and OECD, 2015
- [5] Baggrundsnotat omhandlende metode for Energinet.dk's forventninger til kraftværksudviklingen i Danmark, Energinet.dk, 27. august 2014 (Background note concerning method for Energinet.dk's expectations for power plant development in Denmark , Energinet.dk , August 27, 2014).
- [6] Studstrupværket kører videre på kul frem til 2015, Ingeniøren, 10. maj 2012, (Studstrupværket continues to run on coal until 2015, Engineer , May 10, 2012).
- [7] Ea Energy Analysis, based on experience from various commercial projects.
- [8] It is assumed by Ea Energy Analyses that plants emissions prior to the LTE is within the legal limits.

03 Rebuilding Large Coal Power Plants to Biomass

Contact information:

Danish Energy Agency: Rikke Næraa, rin@ens.dk

Author: Ea Energy Analyses

Publication date

August 2016

Amendments after publication date

Date	Ref.	Description
October 18	03 Rebuilding Large Coal Power Plants to Biomass	Datasheets updated

Qualitative description

Brief technology description

Existing coal power plants may be rebuilt for biomass combustion, mainly in order to reduce CO₂ emissions without discarding existing generating capacity. The conversion to biomass in existing pulverized coal fired power plants may be done partly by co-firing a fraction of biomass together with the coal, or by converting the plant fully to biomass. The data and descriptions in this chapter only consider the full conversion options.

The power plants for rebuilding are assumed to be of age approximately 25 years meaning that a life time extension will be necessary in any case. Thus, the expected costs of lifetime extension are included for those parts of the plant that remain in operation after the rebuilding. It is further assumed that the rebuilt power plant will have a technical life time of 15 years, i.e. the O&M costs will cover the necessary refurbishments in this period.

The necessary works and associated costs for life time extension and rebuilding of existing power plants will in any case vary over a large span since the original power plants are all unique in terms of technical design and condition.

Coal power plants can be modified for biomass in a number of ways. Here the following three concepts are considered:

- a) Wood pellets, existing boiler
- b) Wood chips, new boiler
- c) Wood chips, existing boiler

These options will determine the requirements for the necessary technical modifications and replacements of the fuel handling equipment, boiler systems etc. of the plants.

a) Wood pellets

The easiest and cheapest (concerning the investment costs) solution is to convert the fuel from coal to wood pellets, which is a fuel with the most similar characteristics to coal, meaning that the same boiler can be used. Pellets is a homogeneous and pre-dried fuel of various standardized qualities, produced from biomass material such as wood, wood residues, other energy crops or residues of agricultural production, etc., typically produced abroad and transported to the power plants in large vessels. The pellets have controlled water content, typically below 10% [1]. The energy consumption in the production of the pellets is around 10% of the energy content of the finished product [2], whereas the energy consumption for transportation depends on e.g. the type of ship, the distance and whether or not the ship is returning empty or with cargo. Shipping of pellets from Canada consume around 4% of the energy content in the finished product (efficient ship and full cargo), whereas transportation from the Baltic countries consume approximately 1.5% of the energy content of the finished product [3].

The figure below shows a principle sketch of the plant and which elements are expected to be added, replaced, or refurbished. Among these are:

- New storage silos and transport systems for the pellets
- Coal mills, to be modified and with extended capacity due to lower calorific value
- Larger fans for pneumatic transport systems
- New burners
- Boiler modifications , e.g. soot blowers to avoid deposits
- Other life time extensions, as relevant

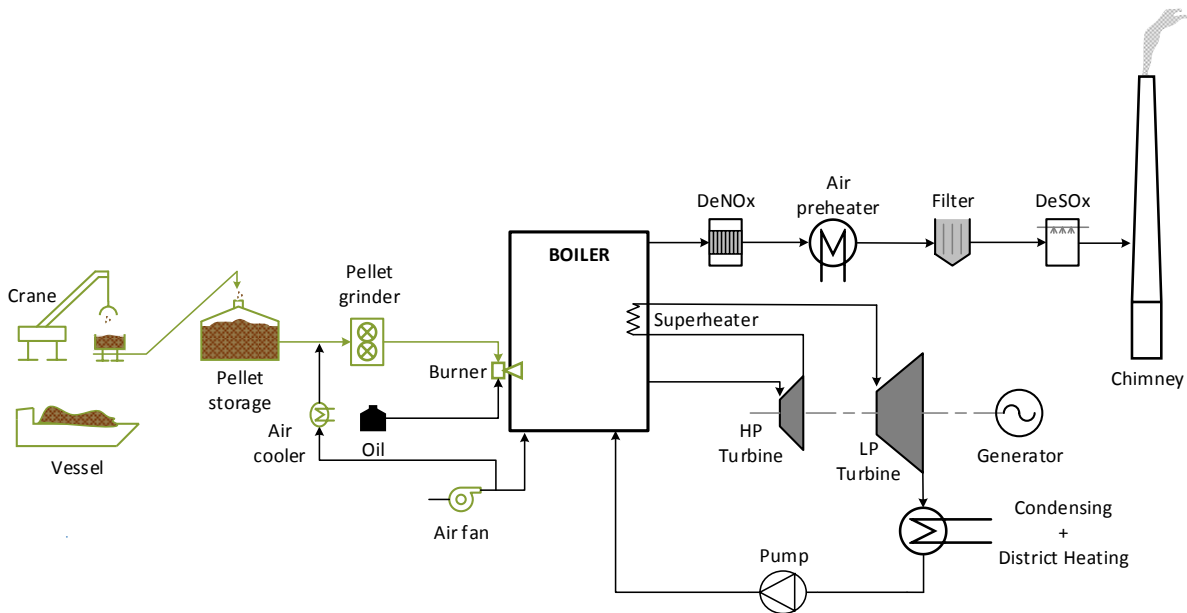

Figure 1:

Sketch of a CHP plant converted to firing with wood pellets. The green elements indicate the equipment that needs to be added, replaced or refurbished.

The existing boilers, flue gas systems, and steam systems can be kept in operation with minor modifications done in connection with the life time extension. It should be considered to by-pass the desulphurization plant as the sulphur content in wood is much lower than in coal. This has been done on Amagerværket Unit 1 to attain higher efficiency. In such cases boiler efficiency and steam data will probably only be marginally affected. Since cold air is used for the fuel feeding less combustion air is heated in the air preheater, and subsequently the heat extracted from flue gas is less than in the original plant resulting in a minor reduction of the boiler efficiency. Application of flue gas condensation is not relevant due to the low water content of the pellets. In the boiler, increased formation of ash and slag deposits, e.g. corrosive chlorines, may normally be expected when shifting from coal to wood firing. This may be remedied by use of steam soot blowers. To improve the chemical processes and avoid deposits and dust formation, an amount of coal or fly ash from coal can be added to the boiler. The lower calorific value of wood compared with coal increases the necessary fuel amounts to approximately double volume. Storage of pellets requires new covered storage facilities. Therefore expansions of harbor facilities and land use for storage may be required. The possible additional costs for this are not considered.

It is here assumed that the boiler can be reused. In case existing boiler steam parameters are outdated or the boiler is worn out it can be beneficial to replace the boiler completely as done on Amagerværket Unit 1.

b) Wood chips, new boiler

Conversion of the fuel type from coal to wood chips requires major changes and is more time consuming and costly than conversion to pellets. However, this could be counterbalanced by a lower fuel price. One

option for converting to wood chips is to install an entire new boiler. Wood chips are a less homogeneous fuel than pellets, with large variations in quality and size. Its water content is high, typically from 20% and up to more than 50%, and it may as well contain fractions of soil. The chipping can take place in the forest where smaller branches and treetops can also be used. Due to the low energy density and high water content wood chips are less suitable for transport over long distances and are most often locally sourced. However, logs can be transported by boat and chopped at the destination site.

The need for boiler replacement is due to the inability of the coal dust fired boiler to be adapted to the larger and inhomogeneous wood chips. For larger units > 200 MWth it is assumed that a circulating fluid bed (CFB) type furnace will be chosen (a chapter on large biomass circulating fluidized bed combustion systems (CFBC) will soon be included in the catalog), whereas bubbling fluid bed (BFB) and grate fired boilers are typically preferred for smaller units up to 150 MWth, but not feasible above this size due to physical limitations. For existing larger plants it is an option though, to build more than one grate fired boiler in parallel when converting to biomass. The data given here are based on the CFB type boiler. Due to the high water content in the fuel the boiler system will be equipped with flue gas condensation for increasing the heat output. The condensation will normally use the district heating return water, but further energy may be recovered by applying heat pumps (not considered in the data sheet).

The amount of condensate water is high due to the fuel's high moisture content. Therefore water treatment costs can be considerable.

Flue gas cleaning and dust filters need to be provided. Due to the lower combustion temperature in CFB the creation of NO_x is lower than in other boilers [4, 5]. Still some kind of DeNO_x plant probably is required. SCR (selective catalytic reduction) will probably be necessary to achieve the NO_x emission limit value in the upcoming European standards⁶. A low duct tail end SCR can be integrated with flue gas cleaning [2]. Due to low sulfur content of woodchips, DeSO_x is normally not required.

Further, the plant needs to be supplemented by a system for storage and handling of the wood chips, which can normally be stored outdoors. As for wood pellets expansions of harbor facilities and land use for storage may be required, but the possible additional costs for this are not considered here.

The figure below shows a principle sketch of the plant and which elements are expected to be added, replaced or refurbished. Among these are:

- New storage and transport systems for the wood chips
- New CFB boiler and air fans
- New high pressure turbine due to lower steam pressure. CFB boiler can also be made as super critical with high steam parameters
- New flue gas system, filters and condensation scrubber and probably also SCR
- Other life time extensions, as relevant

⁶ LCP BREF (140 mg NO_x/Nm³ @ 6% O₂ for plant above 100 MWth)

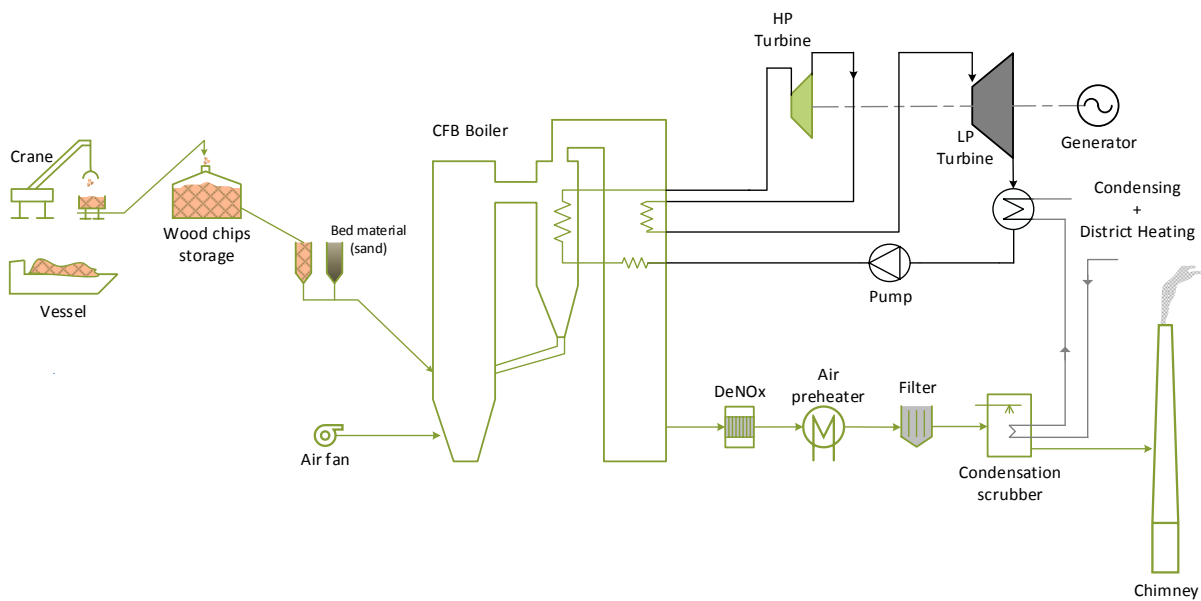

Figure 2: Sketch of a CHP plant converted to firing with wood chips with a new CFB boiler. The green elements indicate the equipment that needs to be added, replaced or refurbished.

c) Wood chips, existing boiler

Another option for converting to wood chips is to reuse the existing boiler but install a plant for processing the chips into dry and fine grained matter, i.e. comparable to the fuel obtained by grinding wood pellets.

Thus, the existing boilers, flue gas systems, and steam systems can be kept in operation with minor modifications done in connection with the life time extension.

The water content of the wood chips must be lowered to usually below 10%, which may be achieved by adding a separate wood chip fired furnace or by using heat from the boiler flue gas. Before the drying the wood chips must be ground down to smaller sizes e.g. in hammer mills, depending on the quality of the raw material. After the drying the final grinding takes place for the fuel to be suitable for the dust-type burners.

Due to the large fuel volumes the storage and preparation plant may constitute a considerable extension of the existing plant. In the cost estimates, no potential expansions of harbor facilities and land use for storage are considered.

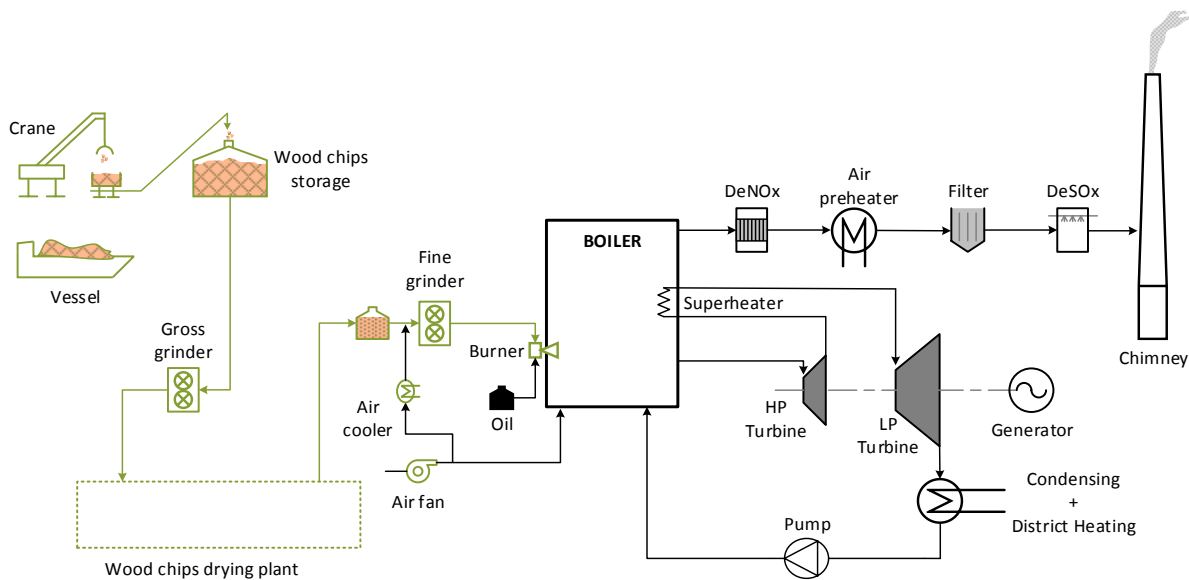

Figure 3: Sketch of a CHP plant converted to firing with wood chips with its existing boiler. The green elements indicate the equipment that needs to be added, replaced or refurbished.

As an alternative to converting the wood chips into pulverized fuel quality the boiler can be modified by installing a grate below the boiler. In such case the heat input on the grate is typically smaller than the original heat input and the plant is down rated accordingly.

Input

Primary fuels are biomass in the form of either a) dried and compressed wood pellets, or b) and c) Wood chips.

Output

The output is electricity and heat for use in district heating systems.

Typical capacities

The capacity range considered is in the range of 200-400 MW_e.

Regulation ability and other power system services

The regulation abilities will in most cases not change much, in case existing boilers of coal fired plants are rebuilt to biomass firing.

The regulation abilities of coal fired power plants with respect to primary and secondary load support are described in the Technology Catalogue item 01. The start-up times from cold state to initial generation for pulverized fuel (PF) and CFB boilers normally vary between 8 and 15 hours the higher end represent the CFB boilers. Typically, a power output of 25% of full capacity can be reached after 3 hours following the initial start-up time during which oil- or gas burners are used [6].

Start-up costs

The direct start-up costs include the fuel consumption for heating up boilers (which is not utilised for energy production), the electricity consumption, and other costs related to operation. The costs of a start-up also depend on the type of fuel used in the start-up period. As for a conventional plant it is normal to use oil or gas to pre-heat the boiler in a biomass converted plant, before the primary fuel is inserted. Thus, the direct start-up costs will not change much due to the shift of fuel from coal to biomass, assuming that fossil fuel could still be used for start-up purpose.

The indirect costs are the lost value corresponding to the lifetime reduction for one start up. For instance, during the heating-up, thermal and pressure variations will cause fatigue damage to components, and corrosion may increase in some areas due to e.g. condensation. This will depend on the initial plant.

Advantages/disadvantages

In general, rebuilding of coal fired power plants to biomass combustion is a relatively fast and cost effective way to reduce the use of fossil fuels (coal). Compared to building entire new units, investments are likely to be significantly lower. Also, the outage periods is likely to be shorter than if an entire new plant should be built at the same location as the one that is assumed rebuild. However, in case of building a new boiler and HP turbine, the advantage in time may not be significant.

One of the disadvantages is that the performance data will be more or less locked by those of the old plant, for instance the efficiencies will depend largely on the allowable steam temperature and pressure. The original plants may be 20-30 years old and therefore not fully live up to the standards of present technology regarding efficiencies etc. Compared to coal, the chemistry of wood combustion causes increased challenges with ash and slag formation and corrosion in the boiler. This makes it necessary to reduce the boiler and steam temperature slightly, and thereby the plant's electrical efficiency is typically also lowered a few percent.

The three rebuilding options have various advantages and disadvantages compared to each other. The use of pre-fabricated wood pellets offers a quick solution for rebuilding older coal power plant with less investment than the other options. On the other hand, the fuel costs are higher.

Wood chips are a cheaper fuel than wood pellets. However, in case of both replacing the boiler and building a fuel drying and processing plant, the investment is higher.

When installing a new boiler for combustion of wood chips, which have a relatively high water content, a higher heat efficiency can be obtained when recovering the condensation heat from the flue gas, though with a somewhat lower electric efficiency. Still, the overall fuel efficiencies may be higher and even above 100% (LHV).

In the case of a CFB-type boiler, and possibly also with converted boilers, the steam pressure is often lower than in the original plant and therefore the high pressure turbine has to be replaced with a new one. However a number of CFB suppliers are able to offer also super critical boilers. Otherwise, the pressure drop over the

high pressure turbine will condense the steam too much, and the low pressure turbine will get steam that is too “wet” and will eventually break faster than it should.

It is common to add coal ashes or coal in the combustion of biomass to prevent slag formation and corrosion in the boiler, this will most likely make the ashes unsuitable for spreading in the environment. At the same time, the recycling of the ashes for use in concrete products, which is normal practice with coal ashes, is questionable with wood ashes due to its high alkali content. The ashes from firing with coal or biomass can be used for producing synthetic gypsum.

Environment

The environmental issues when using biomass as a fuel in rebuilt coal power plants are generally similar to those of new biomass plants. Central issues are emission of particulate matter, NO_x emissions and condensate water. Existing plant configuration often results in higher cost for flue gas cleaning than for new plants.

Another environmental issue is heavy metals in ashes. The ashes from biomass combustion contain minerals that are valuable in agriculture and forestry, and may be recycled. This is subject to regulation involving chemical analysis and controlling concentrations of heavy metals. Especially the cadmium and lead concentrations in the ashes will limit the amounts that can be spread over a certain area per year.

There are several specific health and safety issues connected with the transportation, handling and storage of wood pellets and chips. These involve e.g. the risk of suffocation, self-ignition, explosion, and formation of poisonous molds in storages and transport systems.

Research and development perspectives

Among the areas for further research activities within wood firing is the emission control and handling of residues.

Improvements in operation and maintenance may be gained when further experience is obtained, e.g. in process and emissions control, reduced corrosion rates, material selection for use in boilers, etc. In a wider perspective, a major area for discussion and development is the issue of sustainability connected with the sourcing of the wood material for fueling rebuilt power plants.

Examples of Market Standard technology

Conversion to wood pellets:

DONG Energy Avedøreværket Unit 1, 254 MW_e, ongoing, expected completed in 2016.

DONG Energy has converted several other power plant units to biomass, for example Skærbækværket in 2015-2017 and Herningværket in 2002 and 2009. [7].

GDF Suez plant, Poland, 205 MW_e 2012.

HOFOR Amagerværket Unit 1 pulverized fuel plant converted to wood pellets and a small fraction of straw pellets in 2009.

Prediction of performance in the future

As the technologies for rebuilding power plants have reached a mature stage, only incremental improvements of processes and equipment can be expected. These are largely driven by the emission limitation requirements and therefore not likely to lead to significant cost reductions.

Specific operation and maintenance issues with large biomass units can still be improved along with further experience being gained, and this knowledge can be utilized for converted coal units as well.

In principle, rebuilding will only be interesting as long as existing coal power plants are available, which offer financially interesting investments in competition with other electricity generation technologies.

Uncertainty

The relatively large uncertainty intervals in the investment costs for the rebuilding options reflect mainly the following, in order of magnitude:

- The existing power plants are quite different in terms of design, technical condition size etc. This will widely influence the necessary works for life time extension and adding of new equipment in connection with rebuilding projects.
- There is some uncertainty expected related to general variations of prices and markets in the energy sector, e.g. raw materials like steel and copper, and the supply situation in the construction sector.

Data sheets

The following datasheet shows the technical, environmental and financial data for the specific technology. For more explanation see the section about Quantitative description in the Guideline chapter. The boxes “uncertainty” indicate the uncertainty or range of the parameter. The uncertainty only applies to the row, and cannot be read vertically, i.e. the lower uncertainty of the investment cost does not apply to the lower uncertainty of the capacity.

Technology	03 Rebuilding power plants from coal to biomass									
	a) Wood pellets, existing boiler, extraction plant									
	2015	2020	2030	2050	Uncertainty (2020)		Uncertainty (2050)		Note	Ref
Energy/technical data					Lower	Upper	Lower	Upper		
Generating capacity for one unit (MW)	300				200	400				
Electricity efficiency (condensation mode for extraction plants). net (%). name plate	-1	-1	-1		-0	-2			ABCI	10
Electricity efficiency (condensation mode for extraction plants). net (%). annual average	-1	-1	-1		-0	-2			ABCI	10

Cb coefficient (50°C/100°C)	-0.02	-0.02	-0.02		-0	-0.05			ABCI	10
Cv coefficient (50°C/100°C)	+0	+0	+0		-0.01	+0.01			AC	10
Forced outage (%)	+0	+0	+0		-1	+1			A	10
Planned outage (weeks per year)	+0	+0	+0		+0	+0			A	10
Technical lifetime (years)	15	15	15						C	10
Construction time (years)	2	2	2		1.5	2.5			C	10
Space requirement (1000m2/MW)	+0	+0	+0		+0	+0			AD	
Regulation ability										
Primary regulation (% per 30 seconds)	+0	+0	+0		+0	+0			A	10
Secondary regulation (% per minute)	+0	+0	+0		+0	+0			A	10
Minimum load (% of full load)	+0	+0	+0		+0	+0			A	10
Warm start-up time (hours)	+0	+0	+0		+0	+0			A	10
Cold start-up time (hours)	+0	+0	+0		+0	+0			A	10
Environment										
SO2 (degree of desulphuring. %)	98.3	98.3	98.3		-	-				
NO _x (g per GJ fuel)	20	21	18		19	53			G	
CH4 (g per GJ fuel)	0	0	0		3.1	3.1			G	
N2O (g per GJ fuel)	1	1	1		0.8	0.8			G	
Particles (g per GJ fuel)	0.3	0.3	0.3							
Financial data										
Nominal investment (M€/MW)	0.57	0.56	0.55		0.4	1.1			CE	10, 11, 12
- of which equipment	-	-	-		-	-				
- of which installation	-	-	-		-	-				
Fixed O&M (€/MW/year)	+4,725	+4,725	+4,725		+3,150	+6,300			AF	10
Variable O&M (€/MWh)	+0	+0	+0		+0	+1			AF	10

Notes:

- A Value depends on the original plant. Value indicates the estimated change from the original value (unit is the same as the parameter).
- B Typically the electricity efficiency will be 1-2 % point lower than that of the plant prior to conversion. The thermal efficiency is typically unchanged, thus the C_b value decreases, meaning more heat is produced compared to electricity.
- C Values for year 2050 are not considered relevant since it is assumed that all coal fired plants in Denmark have been rebuilt or decommissioned.
- D Some additional under roof space (or silos) will be required for storage of pellets compared to coal (estimated 50%-100% extra m³ storage). But not more floor space (m²).
- E The nominal investment assumes that the original plant is aged and therefore include investment for a general life time extension campaign
- F The variable O&M costs will be similar to those of the original plant, however fixed O&M costs are likely to increase by 10-20%
- G Assumed the same emission values from the datasheet of new biomass plants (wood chips). See references and notes in the datasheet '09 Biomass CHP, Steam Turbine - Large steam turbine, Woodchips.'
- I It is assumed that plants that are refurbished in 2015 have an electric efficiency of 41% and a C_B coefficient of 0.57. Plants refurbished in 2020 have an electric efficiency of 42% and a C_B coefficient of 0.64. Plants refurbished in 2030 have an electric efficiency of 44% and a C_B coefficient of 0.77. The estimates are made based on Danish CHP plants that are commissioned in 1990, 1995 and 2005.

Technology	03 Rebuilding power plants from coal to biomass b) Wood chips. new boiler, extraction plant									
	2015	2020	2030	2050	Uncertainty (2020)		Uncertainty (2050)		Note	Ref
Energy/technical data					Lower	Upper	Lower	Upper		
Generating capacity for one unit (MW)	300				200	400				
Electricity efficiency (condensation mode for extraction plants). net (%). name plate	-1	-1	-1		-0	-2			ABJ	10
Electricity efficiency (condensation mode for extraction plants). net (%). annual average	-1	-1	-1		-0	-2			ABJ	10
Cb coefficient (50°C/100°C)	-0.07	-0.07	-0.07		-0.02	-0.1			ABJ	10
Cv coefficient (50°C/100°C)	+0	+0	+0		-0.01	+0.01			A	10
Forced outage (%)	+0	+0	+0		-1	+1			A	10
Planned outage (weeks per year)	+0	+0	+0		+0	+0			A	10
Technical lifetime (years)	15	15	15						C	10
Construction time (years)	2.5	2.5	2.5		2	3			C	10
Space requirement (1000m ² /MW)	+0.03	+0.03	+0.03		+0.02	+0.05			AD	10
Regulation ability										
Primary regulation (% per 30 seconds)	-2	-0	-0		-0	-5			AI	10
Secondary regulation (% per minute)	-2	-0	-0		-0	-5			AI	10
Minimum load (% of full load)	+0.05	+0.05	+0		+0	+0.1			A	10
Warm start-up time (hours)	+0.5	+0.5	+0		+0	+2			AI	10
Cold start-up time (hours)	+1	+1	+1		+0	+2			AI	10
Environment										
SO ₂ (degree of desulphuring. %)	98	98	98		-	-				
NO _x (g per GJ fuel)	30	24	20		19	53			G	
CH ₄ (g per GJ fuel)	3	2	2		0	0.5			G	
N ₂ O (g per GJ fuel)	10	8	6		2	20			G	
Particles (g per GJ fuel)	0.3	0.3	0.3							
Financial data (in 2015€)										
Nominal investment (M€/MW)	1.6	1.6	1.6		1.3	2.1			CE	10. 12
- of which equipment	-	-	-		-	-				
- of which installation	-	-	-		-	-				
Fixed O&M (€/MW/year)	+4,725	+4,725	+4,725		+3,150	+6,300			F	10
Variable O&M (€/MWh)	+1,5	+1,5	+1,5		+1	+2			F	10

Notes:

- A Value depends on the original plant.
- B Typically the electricity efficiency will be 1-2 % point lower than that of the plant prior to conversion. The thermal efficiency will typically increase to around 105%, thus the C_b value decreases, meaning more heat is produced compared to electricity. This is mainly due to implementation of flue gas condenser.
- C Values for year 2050 are not considered relevant since it is assumed that all coal fired plants in Denmark have been rebuilt or decommissioned.
- D Some additional space will be required for storage of chips (estimated 50%-100% extra).
- E The nominal investment assumes that the original plant is aged and therefore include investment for a general life time extension campaign
- F The fixed O&M costs are likely to increase by 10-20%, whereas the variable O&M costs are likely to increase approx. 50%.
- G Emission values from the datasheet of new CFB biomass plants. See references and notes in the datasheet 'Large Biomass Circulating Fluidized Bed Combustion Systems (CFBC) for wood'.
- I The regulation time of the boiler will often increase, due to slower burning of chips compared to pulverized fuel. Depending of the other thermal limitations in the cycle (e.g. in the turbines) this will have no change or an increase in the regulation time.
- J It is assumed that plants that are refurbished in 2015 have an electric efficiency of 41% and a C_B coefficient of 0.57. Plants refurbished in 2020 have an electric efficiency of 42% and a C_B coefficient of 0.64. Plants refurbished in 2030 have an electric efficiency of 44% and a C_B coefficient of 0.77. The estimates are made based on Danish CHP plants that are commissioned in 1990, 1995 and 2005.

Technology	03 Rebuilding power plants from coal to biomass c) Wood chips, existing boiler, extraction plant									
	2015	2020	2030	2050	Uncertainty (2020)		Uncertainty (2050)		Note	Ref
Energy/technical data					Lower	Upper	Lower	Upper		
Generating capacity for one unit (MW)	300				200	400				
Electricity efficiency (condensation mode for extraction plants), net (%), name plate	-3	-3	-3		-2	-4			ABI	10
Electricity efficiency (condensation mode for extraction plants), net (%), annual average	-3	-3	-3		-2	-4			ABI	10
Cb coefficient (50°C/100°C)	-0.07	-0.07	-0.07		-0.02	-0.1			ABI	10
Cv coefficient (50°C/100°C)	+0	+0	+0		-0.01	+0.01			A	10
Forced outage (%)	+0	+0	+0		-1	+1			A	10
Planned outage (weeks per year)	+0	+0	+0		+0	+0			A	10
Technical lifetime (years)	15	15	15						C	10
Construction time (years)	2	2	2		1.5	2.5			C	10
Space requirement (1000m ² /MW)	+0.04	+0.04	+0.04		+0.03	+0.06			AD	10
Regulation ability										
Primary regulation (% per 30 seconds)	+0	+0	+0		+0	+0			A	10
Secondary regulation (% per minute)	+0	+0	+0		+0	+0			A	10
Minimum load (% of full load)	+0	+0	+0		+0	+0			A	10
Warm start-up time (hours)	+0	+0	+0		+0	+0			A	10
Cold start-up time (hours)	+0	+0	+0		+0	+0			A	10
Environment										
SO ₂ (degree of desulphuring, %)	98	98	98		-	-			G	
NO _x (g per GJ fuel)	30	24	20		19	53			G	
CH ₄ (g per GJ fuel)	3	2	2		3.1	3.1			G	
N ₂ O (g per GJ fuel)	10	8	6		0.8	0.8			G	
Particles (g per GJ fuel)	0.3	0.3	0.3						G	
Financial data										
Nominal investment (M€/MW)	1.6	1.6	1.6		1.3	2.1			CE	10
- of which equipment	-	-	-		-	-				
- of which installation	-	-	-		-	-				
Fixed O&M (€/MW/year)	+14,175	+14,175	+14,175		+12,600	+15,750			F	10
Variable O&M (€/MWh)	+1,5	+1,5	+1,5		+1	+2			F	10

Notes:

- A Value depends on the original plant.
- B Typically the electricity efficiency will be 3-4 % point lower than that of the plant prior to conversion. The thermal efficiency is increased to approximately 100% because of flue gas condensation in drying process, thus the C_b value decreases, meaning more heat is produced compared to electricity.
- C Values for year 2050 are not considered relevant since it is assumed that all coal fired plants in Denmark have been rebuilt or decommissioned.
- D Some additional space will be required for storage of chips (estimated 50%-100% extra) and for the drying plant.
- E The nominal investment assumes that the original plant is aged and therefore include investment for a general life time extension campaign
- F Both variable and fixed O&M costs are likely to increase by 40-50% from the original plant.
- G Assumed the same emission values from the datasheet of new biomass plants (wood chips). See references and notes in the datasheet '09 Biomass CHP, Steam Turbine - Large steam turbine, Woodchips'.
- I It is assumed that plants that are refurbished in 2015 have an electric efficiency of 41% and a CB coefficient of 0.57. Plants refurbished in 2020 have an electric efficiency of 42% and a CB coefficient of 0.64. Plants refurbished in 2030 have an electric efficiency of 44% and a CB coefficient of 0.77. The estimates are made based on Danish CHP plants that are commissioned in 1990, 1995 and 2005.

References

- [1] Biomass pelleting, European Biomass Industry Association, 2015.
<http://www.eubia.org/index.php/about-biomass/biomass-pelleting>
- [2] Status overview of torrefaction technologies – IEA Bioenergy Task 32, Koppejan et. al, 2012.
- [3] Analysis of biomass prices – future Danish prices for straw, wood chips and wood pellets, Ea Energy Analyses for Danish Energy Agency, 2013.
- [4] Circulating fluidised bed technology - clean, efficient & fuel-flexible, Alstom, 2013.
<http://alstomenergy.gepower.com/Global/Power/Resources/Documents/Brochures/circulating-fluidised-bed-boiler-technology-coal-oil-power-epslanguage=en-GB.pdf>
- [5] Dansk Gasteknisk Center A/S, 2013.
- [6] Assessment of startup period at coal-fired electric generating units, EPA 2013.
- [7] DONG Energy Power plans and experience in Biomass, Presentation Jesper Staal.
https://www.essent.eu/content/Images/90684_04_DONG%20plans%20in%20biomass_Jesper%20Staal.pdf
- [8] Recirkulering af aske i skov -tekniske, økonomiske og økologiske aspekter, I. Callesen, S. Skov og N. Heding, Arbejdsrapport Skov & Landskab nr. 7-2004.
- [9] Informed by BWE A/S, Dec. 2015.
- [10] Ea Energy Analysis, based on experience from various commercial projects.

- [11] Government response to the consultation on proposals for the levels of banded support under the Renewables Obligation for the period 2013-17 and the Renewables Obligation Order 2012, UK Department of Energy and Climate Change, July 2012.
- [12] A strategy for converting coal fueled power plants to biomass, Future Metrics, September 2014

04 Gas Turbine, Simple-Cycle

Contact information:

Danish Energy Agency: Rikke Næraa, rin@ens.dk

Author: Dansk Gasteknisk Center

Publication date

August 2016

Amendments after publication date

Date	Ref.	Description

Qualitative description

Brief technology description

The major components of a simple-cycle (or open-cycle) gas turbine power unit are: a gas turbine, a gear (when needed) and a generator. For cogeneration (combined heat and power production), a flue gas heat exchanger (hot water or steam) is also installed, see the diagram below.

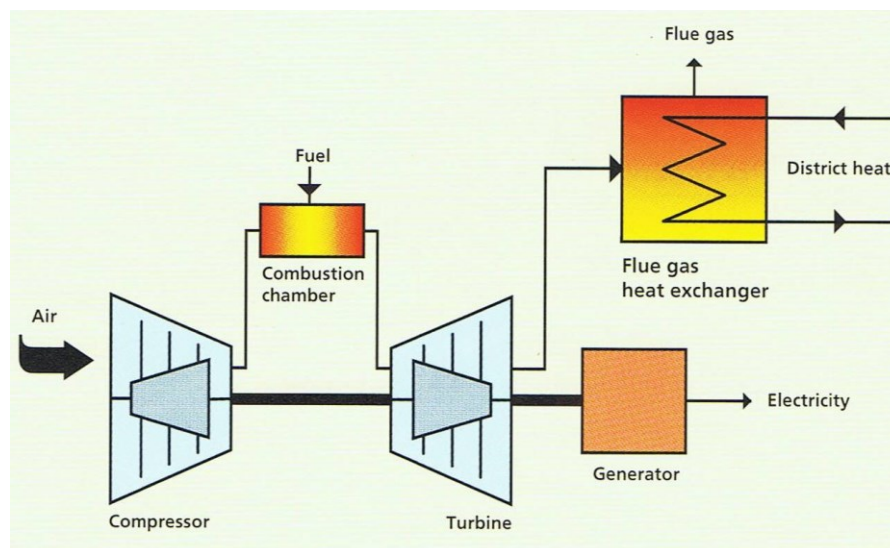

Figure 1 Diagram of a simple cycle plant designed for combined heat and power production.

If applying heat pumps for extra cooling of the exhaust gas, even higher total fuel efficiency can be reached. Depending on priorities, the flue gas heat pumps can be electrical or absorption type.

Simple cycle gas turbines can be used for preheating the feed water of steam power plants. This is the case at the Danish Avedøre 2 power station.

There are in general two types of gas turbines;

1. industrial turbines (also called heavy duty)
2. aero-derivative turbine

Industrial gas turbines differ from aero-derivative turbines in the way that the frames, bearings and blading are of heavier construction. Additionally, industrial gas turbines have longer intervals between services compared to the aero-derivatives.

Aero-derivative turbines benefit from higher efficiency than industrial ones and the most service-demanding module of the aero-derivative gas turbine can normally be replaced in a couple of days, thus keeping a high availability.

Gas turbines can be equipped with compressor intercoolers where the compressed air is cooled to reduce the power needed for compression. The use of integrated recuperators (preheating of the combustion air) to increase efficiency can also be made by using air/air heat exchangers - at the expense of an increased exhaust pressure loss. Gas turbine plants can have direct steam injection in the burner to increase power output through expansion in the turbine section (Cheng Cycle). Direct steam injection is not common for turbines in Denmark

Small (radial) gas turbines below 100 kWe are now on the market, the so-called micro-turbines. These are often equipped with preheating of combustion air based on heat from gas turbine exhaust (integrated recuperator) to achieve reasonable electrical efficiency (25 - 30 %).

Input

Typical fuels are natural gas and light oil. Some gas turbines can be fuelled with other fuels, such as LPG, biogas etc., and some gas turbines are available in dual-fuel versions (gas/oil).

Gas fired gas turbines need an input pressure of the fuel (gas) of 20-60 bar, dependent on the gas turbine compression ratio, i.e. the entry pressure in the combustion chamber. Typically, aero derivative gas turbines need higher fuel (gas) pressure than industrial types.

Output

Electricity and heat (optional). All heat output is from the exhaust gas and is extracted by a flue gas heat exchanger (heat recovery boiler).

The heat output is usually either as steam or hot water.

Typical capacities

Simple-cycle gas turbines are available in the 30 kWe – 450 MWe range [1].

The enclosed data tables cover large scale (40 – 125 MW), medium and small scale (5 - 40 MW) installations. Data on micro gas turbines (0.03 – 0.100 MW) is also presented.

All data are for gas turbines operating in simple cycle cogeneration mode without flue gas condensation, if no additional notes are made.

Regulation ability and other power system services

A simple-cycle gas turbine can be started and stopped within minutes, supplying power during peak demand. Because they are less power efficient than combined cycle plants, they are in most places used as peak or reserve power plants, which operate anywhere from several hours per day to a few dozen hours per year.

However, every start/stop has a measurable influence on service costs and maintenance intervals. As a rule-of-thumb, a start costs 10 hours in technical life expectancy [5].

The flue gas heat exchanger (heat recovery boiler) may lead to some constraints on start-up gradients. This can be solved by including a flue gas bypass.

Gas turbines are able to operate at part load. This reduces the electrical efficiency and at lower loads the emission of e.g. NO_x and CO will increase. The increase in NO_x emissions with decreasing load places a regulatory limitation on the regulation ability. This can be solved in part by adding de-NO_x units.

The heat produced from cooling of the exhaust gas can be either hot water (for district heating or low-temperature process needs) or steam for process needs. Variations in steam production may be achieved by varying the gas turbine load, by supplementary firing in the heat recovery boiler or via a bypass stack.

To operate a simple cycle gas turbine of a cogeneration plant in power-only mode, the exhaust gas is directed to a bypass stack.

Most simple cycle gas turbine plants installations for CHP include short time heat storage. This leads to more flexibility in production planning.

Advantages/disadvantages

Advantages

Simple-cycle gas turbine plants have short start-up/shut-down time, if needed. For normal operation, a hot start will take some 10 - 15 minutes [5,6]. Construction times for gas turbine based simple cycle plants are shorter than steam turbine plants [6].

Disadvantages

Concerning larger units above 15 MW, the combined cycle technology has so far been more attractive than simple cycle gas turbine, when applied in cogeneration plants for district heating [3]. Steam from other sources (e.g. waste fired boilers) can be led to the steam turbine part as well. Hence, the lack of a steam turbine can be considered a disadvantage for large-scale simple cycle gas turbines.

Environment

Gas turbines have continuous combustion with non-cooled walls. This means a very complete combustion and low levels of emissions (other than NO_x). Developments focusing on the combustors have led to low NO_x levels

as stated elsewhere. To lower the emission of NO_x further, post-treatment of the exhaust gas can be applied, e.g. with SCR catalyst systems.

Research and development perspectives

Increased efficiency for simple-cycle gas turbine configurations has also been reached through inter-cooling and recuperators. Research into humidification (water injection) of intake air processes (HAT) is expected to lead to increased efficiency due to higher mass flow through the turbine.

Additionally continuous development for less polluting combustion is taking place. Low-NO_x combustion technology is assumed. Water or steam injection in the burner section may reduce the NO_x emission, but also the total efficiency and thereby possibly the financial viability. The trend is more towards dry low-NO_x combustion, which increases the specific cost of the gas turbine [3]

Examples of market standard technology

The best technology on the market today is a medium size gas turbines with integrated recuperator that can reach approx. 38 % electrical efficiency (5 MWe unit).

Prediction of performance and costs

Gas turbine technology is a well-proven commercial technology with numerous power generating installations worldwide, making simple cycle gas turbines a category 4 technology. Technological improvements are continuously being made; new materials, new surface treatments or improved production methods can lead to higher electrical efficiency, improved lifetime and less service needs.

Developments now also focus on broader gas quality acceptance during operation and improved dynamic performance.

The efficiency of the simple-cycle turbine can be increased, if inlet temperatures to the turbine section can be increased. Therefore development of ceramic materials that can withstand high temperatures used in the hot parts of the gas turbine is taking place.

However, the expectations for the gas turbine market in Denmark are limited, since gas turbines are currently predominantly used in the reserve power market. This means that no significant reductions in investment and/or operation/maintenance costs are expected to be seen in the years to come. In a longer perspective, gas turbines may become relevant for green gas based power production.

Uncertainty

Uncertainty stated in the tables both covers differences related to the power span covered in the actual table and differences in the various products (manufacturer, quality level, extra equipment, service contract guarantees etc.) on the market.

A span for upper and lower product values is given for the year 2020 situation. No sources are available for the 2050 situation. Hence the values have been estimated by the authors.

Additional remarks

Figures for service and maintenance costs are usually based on generated electricity. Service contract may also be on this basis; pricing may be influenced by the number of starts/stops.

Data sheets

Technology	Gas turbine, simple cycle (large), back pressure									
	2015	2020	2030	2050	Uncertainty (2020)		Uncertainty (2050)		Note	Ref
					Lower	Upper	Lower	Upper		
Energy/technical data										
Generating capacity for one unit (MW)	40 - 125								F	
Electricity efficiency (condensation mode for extraction plants), net (%)	41	42	43	45	38	42	40	44		6, 12
Electricity efficiency (condensation mode for extraction plants), net (%), annual average	39	40	41	43	36	40	38	42		6, 11
Cb coefficient (50°C/100°C)	0.95	0.96	1	1	0.8	1.2	0.8	1.2		6, 12
Cv coefficient (50°C/100°C)	-	-	-	-	-	-	-	-	J	
Forced outage (%)	2	2	2	2	2	3	2	3		6
Planned outage (weeks per year)	3	3	2.5	2.5	2	3.5	1.5	3		6
Technical lifetime (years)	25	25	25	25	25	>25	25	>25	E	6, 7
Construction time (years)	1.5	1.5	1.5	1.5	1	2	1	2		6
Space requirement (1000m ² /MW)	0.02	0.02	0.02	0.02	0.015	0.03	0.015	0.03	G	7
Plant Dynamic Capabilities										
Primary regulation (% per 30 seconds)	0	0	0	0	0	0	0	0	I	
Secondary regulation (% per minute)	20	20	20	20	20	50	20	50	C	6
Minimum load (% of full load)	25	23	20	20	20	25	20	25	A	6
Warm start-up time (hours)	0.25	0.23	0.2	0.2	0.1	0.5	0.1	0.4		5, 6, 8
Cold start-up time (hours)	0.5	0.5	0.5	0.5	0.4	1	0.4	1		5, 6, 8
Environment										
SO ₂ (degree of desulphuring, %)	0	0	0	0	0	0	0	0		
NO _x (g per GJ fuel)	20	15	10	10	10	30	7.5	20	D	7, 9
CH ₄ (g per GJ fuel)	1.5	1.5	1.5	1.5	1	8	1	8	G	9
N ₂ O (g per GJ fuel)	1.0	1.0	1.0	1.0	0.7	1.2	0.7	1.2	G	9
Financial data										
Nominal investment (M€/MW)	0.6	0.59	0.56	0.52	0.4	0.9	0.35	0.85		6, 10
- of which equipment	NA	NA	NA	NA	NA	NA	NA	NA	K	
- of which installation	NA	NA	NA	NA	NA	NA	NA	NA	K	
Fixed O&M (€/MW/year)	20,000	19,500	18,600	18,000	NA	NA	NA	NA	B	6
Variable O&M (€/MWh)	4.5	4.4	4.2	4	4	6	3	5		6

Technology	Gas turbine, simple cycle (small and medium scale plant) , back pressure									
	2015	2020	2030	2050	Uncertainty (2020)		Uncertainty (2050)		Note	Ref
Energy/technical data					Lower	Upper	Lower	Upper		
Generating capacity for one unit (MW)	5 - 40								F	
Electricity efficiency (condensation mode for extraction plants), net (%)	36	37	39	40	32	40	34	42	G, H	6, 12
Electricity efficiency (condensation mode for extraction plants), net (%), annual average	34	35	37	38	30	38	32	40		6, 11
Cb coefficient (50°C/100°C)	0.71	0.73	0.8	0.8	0.61	0.8	0.7	0.9		6, 12
Cv coefficient (50°C/100°C)	-	-	-	-	-	-	-	-	J	
Forced outage (%)	2	2	2	2	2	3	2	3		6
Planned outage (weeks per year)	3	2.8	2.5	2.5	2	3.5	1.5	3		6
Technical lifetime (years)	25	25	25	25	25	>25	25	>25	E	6, 7
Construction time (years)	1.5	1.5	1.5	1.5	1	1.5	1	1.5		6
Space requirement (1000m2/MW)	0.04	0.04	0.04	0.04	0.03	0.07	0.03	0.07	G	7
Plant Dynamic Capabilities										
Primary regulation (% per 30 seconds)	0	0	0	0	0	0	0	0	I	
Secondary regulation (% per minute)	20	20	20	20	20	50	20	50	C	6
Minimum load (% of full load)	25	23	20	20	20	25	20	25	A	6
Warm start-up time (hours)	0.25	0.23	0.2	0.2	0.1	0.5	0.1	0.4		5, 6, 8
Cold start-up time (hours)	0.5	0.5	0.5	0.5	0.4	1	0.4	1		5, 6, 8
Environment										
SO ₂ (degree of desulphuring, %)	0	0	0	0	0	0	0	0		
NO _x (g per GJ fuel)	20	15	10	10	10	30	8	20	D	7, 9
CH ₄ (g per GJ fuel)	1.5	1.5	1.5	1.5	1	8	1	8		9
N ₂ O (g per GJ fuel)	1.0	1.0	1.0	1	0.7	1.2	0.7	1.2		9
Financial data										
Nominal investment (M€/MW)	0.75	0.73	0.70	0.68	0.6	1	0.55	0.95		6, 10
- of which equipment	NA	NA	NA	NA	NA	NA	NA	NA	K	
- of which installation	NA	NA	NA	NA	NA	NA	NA	NA	K	
Fixed O&M (€/MW/year)	20,000	19,500	18,600	18,000	NA	NA	NA	NA	B	6
Variable O&M (€/MWh)	5.5	5.4	5.1	4.6	5	7	4	6		6

Technology	Gas turbine, simple cycle (micro) , back pressure									
	2015	2020	2030	2050	Uncertainty (2020)		Uncertainty (2050)		Note	Ref
					Lower	Upper	Lower	Upper		
Energy/technical data										
Generating capacity for one unit (MW)	0.015 - 0.200									
Electricity efficiency (condensation mode for extraction plants), net (%)	30	30	30	30	23	32	25	35	M	7
Electricity efficiency (condensation mode for extraction plants), net (%), annual average	28	28	28	28	21	29	23	33		
Cb coefficient (50°C/100°C)	0.6	0.6	0.6	0.6	0.4	0.85	0.4	0.85		7, 13
Cv coefficient (50°C/100°C)	-	-	-	-	-	-	-	-	J	
Forced outage (%)	5	5	5	5	NA	NA	NA	NA		
Planned outage (weeks per year)	NA	NA	NA	NA	NA	NA	NA	NA		
Technical lifetime (years)	15	15	15	15	10	20	10	20	L	
Construction time (years)	0.5	0.5	0.5	0.5	0.3	0.8	0.2	0.7	L	13
Space requirement (1000m2/MW)	0.06	0.06	0.06	0.06	0.05	0.15	0.05	0.15		7
Plant Dynamic Capabilities										
Primary regulation (% per 30 seconds)	0	0	0	0	0	0	0	0		
Secondary regulation (% per minute)	0	0	0	0	0	0	0	0		
Minimum load (% of full load)	40	40	40	40	30	50	25	50	L	7, 13
Warm start-up time (hours)	0.25	0.25	0.25	0.25	NA	NA	NA	(NA)		
Cold start-up time (hours)	0.5	0.5	0.5	0.5	NA	NA	NA	(NA)		
Environment										
SO ₂ (degree of desulphuring, %)	0	0	0	0	0	0	0	0		13
NO _x (g per GJ fuel)	10	10	10	10	6	15	6	15		7, 13
CH ₄ (g per GJ fuel)	6	6	6	6	NA	NA	NA	NA		13
N ₂ O (g per GJ fuel)	NA	NA	NA	NA	NA	NA	NA	NA		13
Financial data										
Nominal investment (M€/MW)	1.2	1.2	1.1	1.0	NA	NA	NA	NA		13, 14
- of which equipment	0.85	0.85	0.8	0.7	NA	NA	NA	NA		13, 14
- of which installation	0.35	0.35	0.3	0.3	NA	NA	NA	NA		13, 14
Fixed O&M (€/MW/year)	NA	NA	NA	NA	NA	NA	NA	NA		
Variable O&M (€/MWh)	15	15	14	13	10	15	8	15		13

Notes:

- A Very low efficiency at low loads and often increased Nox emission
- B Insurance excluded, unknown. Daily start assumed
- C Power related
- D Based on Dry Low NOx (DLN) techniques
- E Technical- and design life most often > 25 years
- F Electrical output
- G Combined with DGC assumptions, CHP configuration
- H GT's (5 MWe) are available including internal recuperator; the electrical nominal efficiency is then 37 % (LCV basis)
- I No data available, no known use
- J Not relevant for this CHP configuration
- K No data available
- L DGC Estimate
- M Air preheating by internal recuperation included

References

- [1] Major Gas Turbine Suppliers product information available on the Web, 2015 (Online).
- [2] Diesel & Gas Turbine World Wide Catalogue, Brookfield, US (annual publication).
- [3] Cogeneration and On-site Power Production, Ltd., Penwell International.
- [4] Opportunities for Micropower and Fuel Cell/Gas Turbine Hybrid Systems in Industrial Applications, A. D. Little, US, 2000.
- [5] Danish Gas Technology Centre, Analysis on gas engine and gas turbine dynamics, 2013.
- [6] Wärtsilä Technical Journal in detail 02-2014.
- [7] Data specs from manufacturers, 2015 (Web).
- [8] Danish Gas Technology Centre, Analysis and discussion with manufacturers, April 2013.
- [9] Danish Gas Technology Centre, Environmental survey, 2012.
- [10] Smart Power Generation - The future of electricity production, J. Klimstra & M. Hotakainen, 2011.
- [11] IEA: Projected cost of generating electricity, 2010.
- [12] COWI 2015 input.
- [13] The Omes Project results, 2005.
- [14] WBDG-Publication, B. L. Capehart, Microturbines, 2014.

05 Gas Turbine Combined-Cycle

Contact information:

Danish Energy Agency: Rikke Næraa, rin@ens.dk

Energinet.dk: Rune Grandal, rdg@energinet.dk

Author: Dansk Gasteknisk Center

Publication date

August 2016

Amendments after publication date

Date	Ref.	Description
January 2018	05 Combined cycle gas turbine	Additional references have been included

Qualitative description

Brief technology description

Main components of combined-cycle gas turbine (CC-GT) plants include: a gas turbine, a steam turbine, a gear (if needed), a generator, and a heat recovery steam generator (HRSG)/flue gas heat exchanger, see the diagram below.

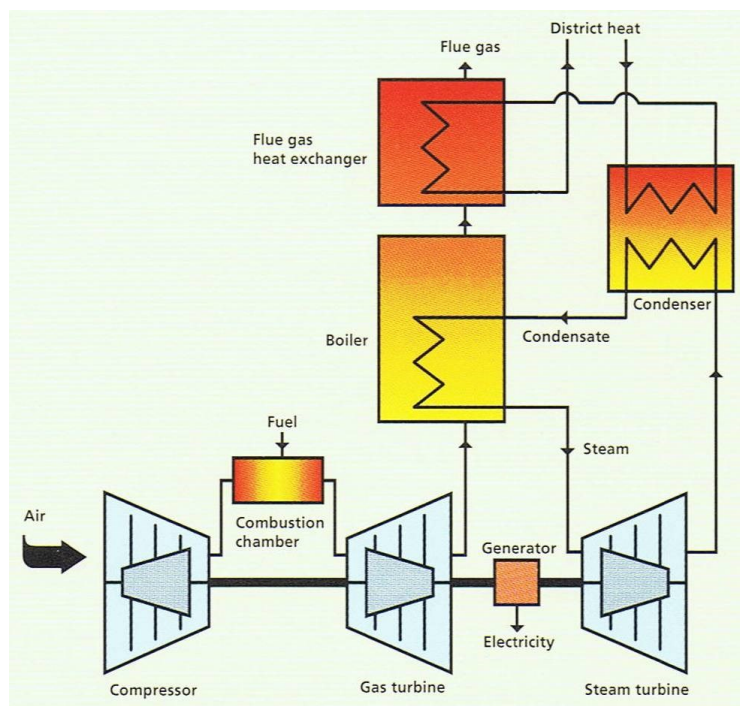

Figure 1 Diagram showing an example of a CC-GT plant designed for combined heat and power production.

The gas turbine and the steam turbine are shown driving a shared generator. In real plants, the two turbines might drive separate generators. Where the single-shaft configuration contributes with higher reliability, the multi-shaft has a slightly better overall performance.

The condenser is cooled by the return water from the district heating network. Since this water is afterwards heated by the flue gas from the gas turbine, the condensation temperature can be fairly low.

The overall energy efficiency depends on the flue gas stack temperature, while the electricity efficiency depends, besides the technical characteristics and the ambient conditions, on the district heating flow temperature. However, some plants do not have the option to sell district heating, and the condenser is therefore cooled by a sea/river/lake or a cooling tower.

If applying heat pumps for extra cooling of the exhaust gas, even higher total fuel efficiency can be reached. Depending on priorities, the flue gas heat pumps can be electrical or absorption type.

The heat recovery steam generator (HRSG) is defined through the number of pressure levels, each producing steam for the steam turbine. Small, medium and large scale units usually have one or two steam pressure stages whereas very large units may have three steam pressure stages. Steam is fed to the turbine both at the inlet and at a later stage between the two adjacent steam turbine sections; this is one of the special features of steam turbines in CC-GT.

Plants being able to shift between condensation mode (power only) and back-pressure mode (power and district heat) include a so-called extraction steam turbine. Such turbines are not available in small sizes, and dual-mode plants are therefore only feasible in large scale.

The power generated by the gas turbine is typically two to three times the power generated by the steam turbine. An extraction steam turbine shifting from full condensation mode at sea temperature to full back-pressure mode at district heat return temperature will typically lose about 10% of its electricity generation capacity. For example, a 40 MW gas turbine combined with a 20 MW steam turbine (condensation mode), loses 2 MW, (10% of 20 MW) or 3% of the total generating capacity (60 MW).

Input

Typical fuels are natural gas and light oil. Some gas turbines can be fuelled with other fuels, such as LPG, biogas etc., and some gas turbines are available in dual-fuel versions (gas/oil).

Gas fired gas turbines need a fuel gas pressure of 20-60 bar, typically aero-derivative gas turbines need higher pressure than industrial gas turbines.

Additional steam from other sources may be fed to the steam turbine section.

Output

Electricity and heat. The heat is most often supplied as hot water.

Typical capacities

The enclosed datasheets cover large scale CC-GT (100 – 400 MW with extraction steam turbine) and medium scale (10 – 100 MW with back pressure steam turbine).

Most CC-GT units has an electric power of > 40 MWe

Regulation ability and other power system services

CC-GT units are to some extent able to operate at part load. This will reduce the electrical efficiency and often increase the NOx emission.

If the steam turbine is not running, the gas turbine can still be operated by directing the hot flue gasses through a boiler designed for high temperature or into a bypass stack.

The larger gas turbines for CC-GT installations are usually equipped with variable inlet guide vanes, which will improve the part-load efficiencies in the 85-100 % load range, thus making the part-load efficiencies comparable with conventional steam power plants in this load range. Another means to improve part-load efficiencies is to split the total generation capacity into several CC-GTs. However, this will generally lead to a lower full load efficiency compared to one larger unit.

The NOx emission is generally increased during part load operation.

Some suppliers have developed CC-GT system designs enabling short start up both regarding the electrical output and the steam circuit as well.

Most CC-GT plants installations include a short time heat storage. This leads to more flexibility in production planning.

Advantages/disadvantages

Advantages

Large gas turbine based combined-cycle units are world leading with regard to electricity production efficiency among fuel based power production.

Smaller CC-GT units have lower electrical efficiencies compared to larger units. Units below 20 MWe are few and will face close competition with single-cycle gas turbines and reciprocating engines.

Gas fired CC-GTs are characterized by low capital costs, high electricity efficiencies, short construction times and short start-up times.

Disadvantages

The economies of scale are substantial, i.e. the specific cost of plants below 200 MWe increases as capacity decreases.

The high air/fuel ratio for gas turbines leads to lower overall efficiency for a given flue gas cooling temperature compared to steam cycles and cogeneration based on internal combustion engines.

Environment

Gas turbines have continuous combustion with non-cooled walls in the combustion chamber. This means a very complete combustion and low levels of emissions (except for NO_x). Developments focusing on the combustor(s) have led to low NO_x levels.

Flue gas post-treatment can consist of SCR catalyst systems etc.

Research and development perspectives

Continuous research is done concerning higher inlet temperature at first turbine blades to achieve higher electricity efficiency. This research is focused on materials and/or cooling of blades.

Continuous development for less polluting combustion is taking place. Increasing the turbine inlet temperature may increase the NO_x production. To keep a low NO_x emission different options are at hand or are being developed, i.e. dry low-NO_x burners, catalytic burners etc.

Development to achieve shorter time for service is also being done.

Examples of market standard technology

Large CC-GT units have demonstrated an electrical efficiency of 60 % (LHV reference). Systems are now being offered and built with an electrical efficiency close to 62 %. The units are large units with an output in the 500 – 600 MWe [3].

In 2009, Eon opened one of the most efficient power plants in Europe, the CHP plant Öresundsverket in Malmö, Sweden. The 440 MW CC-GT has an electrical efficiency of 58% and an overall fuel efficiency in full cogeneration mode of 90%. The total investment figure for the project was €300 million [12].

Prediction of performance and costs

Gas turbine based combined cycle plants are a well-proven, widespread and available technology, making CC-GT a category 4 technology. Improvements are still being made primarily on the gas and steam turbines used. Developments for faster load response and dynamic capabilities are now also in focus. In [13] examples is given for a large (>250 MWe) CC-GT plant with full GT power in less than 15 minutes and approx. 70 % power supply from the steam turbine. Full steam turbine power is achieved in less than one hour.

The expected market in Denmark is limited and declining for the time being. This means that no significant reductions in investment and/or operation/maintenance cost is expected in the years to come. In a longer perspective, gas turbines or gas turbine combined cycle plants may become relevant for green gas based balancing power.

Uncertainty

Uncertainty stated in the tables both covers differences related to the power span covered in the actual table and differences between the various products (manufacturer, quality level, extra equipment, service contract guarantees etc.) on the market.

A span for upper and lower product values is given for the year 2020 situation. No sources are available for the 2050 situation. Hence the values have been estimated by the authors.

Additional remarks

The main rotating parts (the gas turbine, steam turbine and the generator) tend to account for around 45-50% of the investment costs (EPC price), the heat recovery steam generator, condenser and cooling system for around 20%, the balance of plant components for around 15%, the civil works for around 15% and the remainder being miscellaneous other items [10].

Data sheets

Technology	Gas turbine, combined cycle, extraction plant									
	2015	2020	2030	2050	Uncertainty (2020)		Uncertainty (2050)		Note	Ref
Energy/technical data					Lower	Upper	Lower	Upper		
Generating capacity for one unit (MW)	100 - 500								F	
Electricity efficiency (condensation mode for extraction plants), net (%),	58	59	61	63	55	61	58	65		5
Electricity efficiency (condensation mode for extraction plants), net (%), annual average	55	56	58	60	52	58	55	62		5, 9
Cb coefficient (50°C/100°C)	1.7	1.8	2	2.2	1.5	2.2	1.5	2.4		
Cv coefficient (50°C/100°C)	0.15	0.15	0.15	0.15	N.A	N.A	N.A	N.A	J	
Forced outage (%)	3	3	3	3	2	4	2	4		5
Planned outage (weeks per year)	2.5	2.3	2	2	2	4	2	4		5
Technical lifetime (years)	25	25	25	25	25	>25	25	>25	E	5, 3
Construction time (years)	2.5	2.5	2.5	2.5	2	3	2	3		5
Space requirement (1000m ² /MW)	0.02	0.02	0.02	0.02	0.015	0.03	0.015	0.03	G	3
Plant Dynamic Capabilities										
Primary regulation (% per 30 seconds)	-	-	-	-	-	-	-	-	K	
Secondary regulation (% per minute)	15	15	15	15	5	15	5	15		5, 3, 11
Minimum load (% of full load)	40	40	40	40	30	50	30	50	A	5, 3, 11
Warm start-up time (hours)	1	1	1	1	0.5	1.5	0.5	1.5	H	5, 6, 1, 11
Cold start-up time (hours)	2.5	2.5	2.5	2	2	5	1.5	5		5, 6, 1, 11
Environment										
SO ₂ (degree of desulphuring, %)	0	0	0	0	0	0	0	0		
NO _x (g per GJ fuel)	20	15	10	8	10	30	5	15	D	3, 7
CH ₄ (g per GJ fuel)	1.5	1.5	1.5	1.5	1	8	1	8	G	7
N ₂ O (g per GJ fuel)	1	1	1	1	0.7	1.2	0.7	1.2	G	7

Financial data										
Nominal investment (M€/MW)	0.9	0.88	0.83	0.8	0.8	1.2	0.7	1.1		5, 8
- of which equipment	0.7	0.68	0.64	0.61	0.65	1.02	0.6	0.95		10
- of which installation	0.2	0.20	0.19	0.19	0.15	0.18	0.1	0.15		10
Fixed O&M (€/MW/year)	30,000	29,300	27,800	26,000	25,000	35,000	20,000	30,000	B	5
Variable O&M (€/MWh)	4.5	4.4	4.2	4	3	7	3	7		5

Technology	Gas turbine, combined cycle (back-pressure)									
	2015	2020	2030	2050	Uncertainty (2020)		Uncertainty (2050)		Note	Ref
Energy/technical data					Lower	Upper	Lower	Upper		
Generating capacity for one unit (MW)	10 -100								F	
Electricity efficiency (condensation mode for extraction plants), net (%),	50	51	53	55	42	55	45	58		5
Electricity efficiency (condensation mode for extraction plants), net (%), annual average	47	48	50	52	39	52	42	55		5, 9
Cb coefficient (50°C/100°C)	1.2	1.3	1.4	1.55	0.9	1.6	1.1	1.7		
Cv coefficient (50°C/100°C)	-	-	-	-	-	-	-	-	L	
Forced outage (%)	3	3	3	3	2	4	2	4		5
Planned outage (weeks per year)	2.5	2.3	2	2	2	4	1.5	4		5
Technical lifetime (years)	25	25	25	25	25	>25	25	>25	E	5, 3
Construction time (years)	2.5	2	2	2	2	3	2	3		5
Space requirement (1000m2/MW)	0.025	0.025	0.025	0.025	0.019	0.038	0.019	0.038	G	3
Plant Dynamic Capabilities										
Primary regulation (% per 30 seconds)	-	-	-	-	-	-	-	-	I	
Secondary regulation (% per minute)	15	15	15	15	5	15	5	15	C, M	5, 3, 11
Minimum load (% of full load)	40	40	40	40	30	50	30	50	A	5, 3, 11
Warm start-up time (hours)	1	1	1	1	0.5	1.5	0.5	1.5	H	5, 6, 1, 11
Cold start-up time (hours)	2.5	2.5	2.5	2	2	5	1.5	5		5, 6, 1, 11
Environment										
SO ₂ (degree of desulphuring, %)	0	0	0	0	0	0	0	0		
NO _x (g per GJ fuel)	20	15	10	8	10	30	5	15	D	3, 7
CH ₄ (g per GJ fuel)	1.5	1.5	1.5	1.5	1	8	1	8	G	7
N ₂ O (g per GJ fuel)	1	1	1	1	0.7	1.2	0.7	1.2	G	7
Financial data										
Nominal investment (M€/MW)	1.3	1.3	1.2	1.1	1.1	1.8	0.9	1.6		5, 9
- of which equipment	1	1.0	0.9	0.8	0.8	1.4	0.65	1.25		10
- of which installation	0.3	0.3	0.3	0.3	0.3	0.4	0.25	0.35		10
Fixed O&M (€/MW/year)	30,000	29,300	27,800	26,000	25,000	35,000	20,000	30,000	B	5
Variable O&M (€/MWh)	4.5	4.4	4.2	4	3	7	3	7		5

Notes:

- A Low efficiency at low loads and often increased NOx emission
- B Limited availability of data
- C Power related
- D Based on Dry Low NOx (DLN) techniques
- E Technical- and design life most often > 25 years
- F Electrical output
- G CHP configuration, Including DGC assumptions
- H Manufacturers says down to 30 minute
- I No data available
- J Data on Cv from the 2012 version roughly adjusted for higher electricity efficiency
- K No known use
- L No Relevance for Back Pressure Lay Out
- M Upward regulation is typically 10 - 15 %/min, while downward regulation is > 30 % /min

References

- [1] Danish Gas Technology Centre, Analysis on Gas Engine and Gas Turbine Dynamics, 2013.
- [2] Major Gas Turbine Suppliers product information available on the Web, 2015 [Online].
- [3] Data specs from manufacturers (Web), 2015.
- [4] Opportunities for Micropower and Fuel Cell/Gas Turbine Hybrid Systems in Industrial Applications, A. D. Little, US, 2000.
- [5] Wärtsila Technical Journal in detail 02-2014.
- [6] Danish Gas Technology Centre, Analysis and discussion with manufacturers, April 2013.
- [7] Danish Gas Technology Centre, Environmental survey, 2012.
- [8] Smart Power Generation - The future of electricity production, J. Klimstra & M. Hotakainen, 2011.
- [9] IEA: Projected cost of generating electricity, 2010.
- [10] UK Electricity Generation Costs Update, M.M. Donald, June 2010.
- [11] Siemens: Data on GT-CC, 2010.
- [12] EuroHeat&Power, vol. 6, III/2009
- [13] Siemens Flex-Plant™ CC-GT concepts, presentations 2013

06 Gas Engines

Contact information:

Danish Energy Agency: Rikke Næraa, rin@ens.dk

Energinet.dk: Rune Grandal, rdg@energinet.dk

Author: Dansk Gasteknisk Center

Publication date

August 2016

Amendments after publication date

Date	Ref.	Description
January 2018	06 Gas engines	Reference sheet have been updated

Qualitative description

Brief technology description

A gas engine for co-generation of heat and power drives an electricity generator for the power production. Electrical efficiency up to 45- 48 % can be achieved. The engine cooling water (engine cooling, lube oil and turbocharger intercooling) and the hot exhaust gas can be used for heat generation, e.g. for district heating or low-pressure steam.

In district heating systems with low return temperatures both sensible and latent heat in the exhaust gas can be recovered by using a condensing cooler as the final cooling of the flue gasses and a total efficiency of approx. 96-98% can be reached. If applying heat pumps for extra cooling of the exhaust gas system, 5-7% higher total efficiency can be reached. The flue gas heat pumps can be electrical or absorption type.

Two combustion concepts are available for spark ignition engines; lean-burn and stoichiometric combustion engines. Lean-burn engines have a high air/fuel-ratio. The combustion temperature and hence the NO_x emission is thereby reduced. The engines can be equipped with oxidation catalysts for CO-reduction.

In stoichiometric combustion engines, the amount of air is just sufficient for (theoretically) complete combustion. For this technology, the NO_x emission must be reduced in a 3-way catalyst. Only few of such engines are used for combined heat and power production in Denmark. These engines are usually in the lowest power range (< 150 kWe).

Pre-chamber lean-burn combustion system is a common technology for engines with a bore size typically larger than 200 mm. This technology helps to maximize electrical efficiency and increases combustion stability along with low NO_x emissions.

Another ignition technology is used in dual-fuel engines. A dual-fuel engine (diesel-gas) with pilot oil injection is a gas engine that - instead of spark plugs - uses a small amount of light oil (1 - 6%) to ignite the air-gas mix by compression (as in a diesel engine). Dual fuel engines can often operate on diesel oil alone as well as on gas with pilot oil for ignition.

More than 800 gas engines for combined heat and power production are installed in Denmark [4].

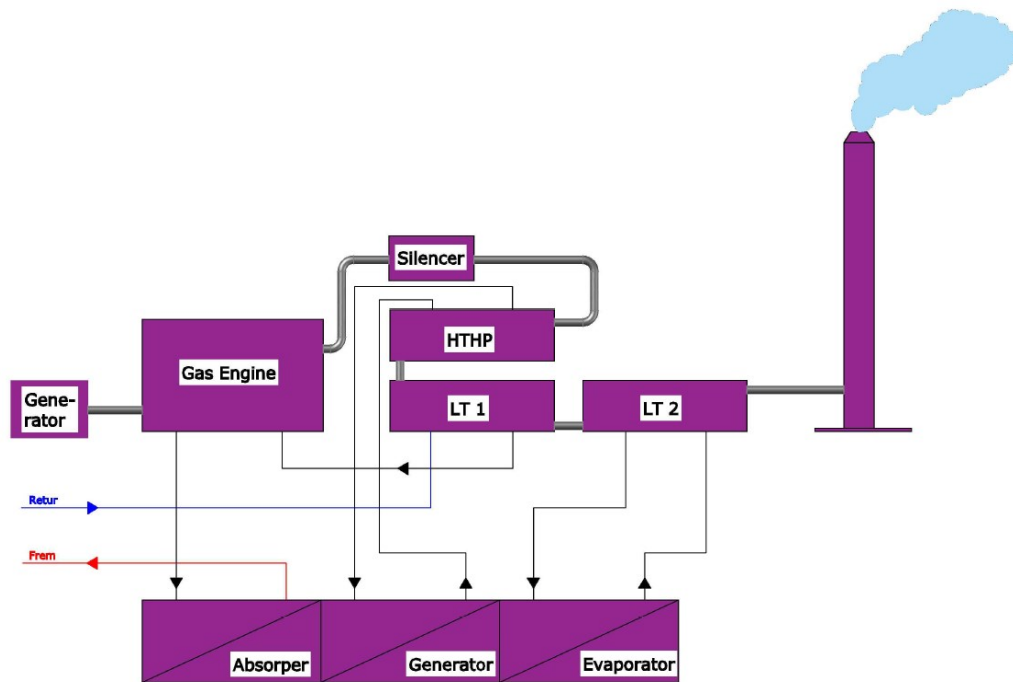

Figure 1 A gas engine based cogeneration unit with heat recovery boilers and an absorption heat pump to obtain a high heat production and highest possible overall efficiency. The heat pump is steam driven [9].

Input

Gas, e.g. natural gas, biogas, landfill gas, special gas and syngas (from thermal gasification) can be input to gas engines. Multi-fuel engines are also on the market, and installations are in service in Denmark and abroad.

In recent years, engines have been developed to use gasses with increasingly lower heating values.

Output

Electricity and heat (district heat; low-pressure steam; industrial drying processes; absorption cooling) are output of the gas engine.

Typical capacities

5 kW_e - 10 MW_e per engine.

Regulation ability and other power system services

Gas engines can start faster than most other electricity production technologies. For many engines 5-15 minutes are needed. Large gas engines have been successfully developed and tested for start to full electrical load in less than one minute. Engines have been developed for fuel switch during operation [7].

Part load is possible with only slightly decreased electric efficiency. The dual-fuel engines have the least decrease of efficiency at part load. Gas engines have better part load characteristics than gas turbines.

To operate a gas engine in power-only mode, the exhaust gas can be emitted directly to the atmosphere without heat extraction (but with de-NO_x if required), whereas engine heat (about 50% of total heat) must be removed by a cooler. Approximately 10% of O&M costs can be saved in power-only mode [7].

Most gas engine based CHP plants installations include a short time heat storage. This leads to more flexibility in production planning.

Advantages/disadvantages

Advantages

Gas engines are known and proven technology making it a highly reliable technology.

Gas engines can operate on moderate gas pressures. Gas engines can be supplied by a gas pressure of less than 1 bar(g). The pre-chamber lean-burn technology often requires a pressure for the pre-chambers of approx. 4 bar(g).

Disadvantages

Gas engines cannot be used to produce considerable amounts of high-pressure steam, as approx. 50 % of the waste heat is released at lower temperatures.

Environment

Spark ignition engines comply with national regulations within EU by using catalyst and/or lean-burn technology to reduce the NO_x emission.

The content of other air pollutants than NO_x in the flue gas from a gas engine is generally low.

Research and development perspectives

Multi-fuel or flexible fuel operation has been introduced, and R&D efforts are continuously put into this. Engines with almost instantaneous shift from gas to diesel and vice versa have been developed and demonstrated.

Short start-up, fast load response and other grid services are becoming more important as more fluctuating power sources are supplying power grids. Gas engines have a potential for supplying such services, and R&D efforts are put into this.

R&D in further emission reduction is continuously taking place; biogas and other such gasses may lead to new catalytic post treatment solutions.

Examples of market standard technology

Best available technology from an efficiency point of view will be a large gas engine with approx. 48-50 % electrical efficiency and a total fuel efficiency of some 106% if fitted with an absorption heat pump using the outlet flue gas as heat source.

Engine based cogeneration units can be fitted with a small low pressure steam turbine for extra power generation.

From a grid service point of view (power balancing and backup) engines with a start to full electrical load in less than one minute is the best available technology.

Prediction of performance and costs

Cogeneration based on gas engines is a proven and commercial technology in Denmark and abroad. Development still takes place mostly related to advanced control and diagnostic systems, making gas engines a category 4 technology. Development also takes place related to efficiency improvements, auxiliary equipment as heat pumps and/or heat driven cooling systems (tri-generation).

Gas engines are now being developed for wider acceptance of various fuel compositions. This includes operation on upgraded biogas.

Even higher electrical production efficiency can be reached by including small low pressure steam turbines to the shaft. This is being tested and supplied to some larger gas engine makes; it improves the mechanical/electrical efficiency by 2-4 percentage points.

A number of gas engine based cogeneration plants have increased their heat output and the total overall efficiency by including heat driven absorption heat pumps in the cogeneration system configuration. The outlet flue gas can be cooled to a temperature less than the available cooling water, and total efficiencies up to approx. 106% have been achieved.

For shorter start-up time services, new designs/solutions on the water side are needed to avoid sudden temperature disturbances in the heat supply.

The expected market in Denmark is limited and declining as well as the annual operation hours. This means that no significant reductions in investment and/or operation/maintenance cost are expected to be seen in the years to come.

Uncertainty

Uncertainty stated in the tables both covers differences related to the power span covered in the actual table and differences between the various products (manufacturer, quality level, extra equipment, service contract guarantees etc.) on the market.

A span for upper and lower product values is given for the year 2020 situation. No sources are available for the 2050 situation. Hence the values have been estimated by the authors.

Additional remarks

The information given in tables is for gas fired (n-gas and biogas) engines only. The natural gas basis is the natural gas supplied in Denmark according to regulations. The biogas basis is a methane/CO₂ mixture (digestion of manure and/or industrial organic waste).

Data sheets

Technology	06 Spark ignition engine, natural gas									
	2015	2020	2030	2050	Uncertainty (2020)		Uncertainty (2050)		Note	Ref
Energy/technical data	Lower		Upper		Lower		Upper			
Generating capacity for one unit (MW)	1 -10 MWe									
Electricity efficiency (condensation mode for extraction plants), net (%)	46	47	48	50	40	48	44	52	A	3, 4
Electricity efficiency (condensation mode for extraction plants), net (%), annual average	44	45	47	48	38	46	42	50	A	3, 4, 7
Cb coefficient (50°C/100°C)	0.9	0.95	0.99	1.04	0.65	1.02	0.65	1.15		3, 4, 7
Cv coefficient (50°C/100°C)	-	-	-	-	-	-	-	-	G	
Forced outage (%)	3	3	3	3	2	5	2	5		5, 6
Planned outage (weeks per year)	0.8	0.8	0.8	0.8	N.A	N.A	N.A	N.A	H	5, 6
Technical lifetime (years)	25	25	25	25	25	>25	25	>25	D	4, 5, 7
Construction time (years)	1	1	1	1	0.5	1.5	0.5	1.5	B	3, 6
Space requirement (1000m ² /MW)	0.04	0.04	0.035	0.03	0.03	0.05	0.025	0.04		
Plant Dynamic Capabilities										
Primary regulation (% per 30 seconds)	25	30	35	50	10	40	25	100		12
Secondary regulation (% per minute)	25	30	40	50	20	100	25	100	C	6, 12, 13
Minimum load (% of full load)	50	50	50	50	30	50	25	50		6
Warm start-up time (hours)	0.05	0.05	0.05	0.05	0.015	0.15	0.015	0.15	C	6, 10
Cold start-up time (hours)	0.3	0.3	0.3	0.3	0.2	0.4	0.2	0.4	E	6, 10
Environment										
SO ₂ (degree of desulphuring, %)	0	0	0	0	0	0	0	0		4
NO _x (g per GJ fuel)	75	60	60	60	50	100	50	100		4
CH ₄ (g per GJ fuel)	315	315	280	250	300	400	250	350		4
N ₂ O (g per GJ fuel)	0.6	0.6	0.6	0.6	N.A	N.A	N.A	N.A	H	
Financial data										
Nominal investment (M€/MW)	1	0.95	0.9	0.85	0.9	1.1	0.8	1.1		3, 5, 11
- of which equipment	0.65	0.6	0.55	0.55	N.A	N.A	N.A	N.A	H	3, 5
- of which installation	0.35	0.35	0.35	0.3	N.A	N.A	N.A	N.A	H	3, 5
Fixed O&M (€/MW/year)	10,000	9,750	9,300	8,500	7,000	20,000	6,000	15,000	F	5
Variable O&M (€/MWh)	5.4	5.4	5.1	4.9	4	12	4	10	F	3, 5, 11

Technology	06 Spark ignition engine, biogas									
	2015	2020	2030	2050	Uncertainty (2020)		Uncertainty (2050)		Note	Ref
Energy/technical data					Lower	Upper	Lower	Upper		
Generating capacity for one unit (MW)	1-10 MWe									
Electricity efficiency (condensation mode for extraction plants), net (%),	42	43	45	47	38	44	42	48	A	3, 4
Electricity efficiency (condensation mode for extraction plants), net (%), annual average	40	41	43	45	36	42	40	46	A	3, 4, 7
Cb coefficient (50°C/100°C)	0.82	0.86	0.92	1	0.59	0.96	0.75	1.1		3, 4, 7
Cv coefficient (50°C/100°C)	-	-	-	-	-	-	-	-	G	
Forced outage (%)	3	3	3	3	2	5	2	5		5, 6
Planned outage (weeks per year)	1	1	1	1	N.A	N.A	N.A	N.A	H	5, 6
Technical lifetime (years)	25	25	25	25	25	>25	25	>25	D	4, 5, 7
Construction time (years)	1	1	1	1	0.5	1.5	0.5	1.5	B	3, 6
Space requirement (1000m ² /MW)	0.04	0.04	0.035	0.03	0.03	0.05	0.025	0.05		
Plant Dynamic Capabilities										
Primary regulation (% per 30 seconds)	25	30	40	50	10	40	25	100	J	8
Secondary regulation (% per minute)	25	30	40	50	20	100	25	100	C	6, 8, 13
Minimum load (% of full load)	50	50	50	50	30	50	25	50		6
Warm start-up time (hours)	0.05	0.05	0.05	0.05	0.015	0.15	0.015	0.15	C	6, 10
Cold start-up time (hours)	0.3	0.3	0.3	0.3	0.2	0.4	0.2	0.4	E	6, 10
Environment										
SO ₂ (degree of desulphuring, %)	(l)	(l)	(l)	(l)	0	99.9	0	99.9	K	8
NO _x (g per GJ fuel)	100	100	100	100	90	120	90	120		4
CH ₄ (g per GJ fuel)	300	300	300	300	300	400	300	400		4
N ₂ O (g per GJ fuel)	1.0	1.0	1.0	1.0	N.A	N.A	N.A	N.A	J	
Financial data										
Nominal investment (M€/MW)	1	0.95	0.9	0.85	0.8	1.2	0.8	1.2		3, 5, 11
- of which equipment	0.65	0.6	0.55	0.55	N.A	N.A	N.A	N.A		3, 5
- of which installation	0.35	0.35	0.35	0.3	N.A	N.A	N.A	N.A		3, 5
Fixed O&M (€/MW/year)	10,000	9,750	9,300	8,500	7,000	20,000	6,000	15,000	F	5
Variable O&M (€/MWh)	8	7.5	7	6	6	13	4	12	F	3, 5, 11

Notes:

- A Ref 1, 2 and 3 is used for 2015 values for 3 - 10 MWe engine, 1 MWe engine 4-5 % points less. Ref 4 & 5 is used for predictions for the future years.
- B The construction time given is for a medium size installation; small installations can be erected in a shorter period
- C Engines have been build and demonstrated for short start up < 1 minute for full electrical load. This includes large engines
- D Technical- and design life most often > 25 years
- E For a medium size engine; small engines with less thermal mass might be faster
- F When operating 4000 hours a year
- G Only relevant for steam based CHP
- H No data available
- I DGC estimate for years 2030, 2050
- J No known use, data from n-gas engines
- K Sulphur is removed in the biogas processing, according to manufactures spec. Lower values for biogas from waste water

References

- [1] Cogeneration and On-site Power Production, Ltd., Penwell International.
- [2] Opportunities for Micropower and Fuel Cell/Gas Turbine Hybrid Systems in Industrial Applications, A. D. Little, US, 2000.
- [3] ASUE BHKW Kenndata 2014/2015.
- [4] DGC statistics, Efficiency and emission test reports.
- [5] DGC analysis, The gas fired cogeneration sector, Bilagsrapport 9, Energiforligsanalyse 2013.
- [6] Features and parameters of various power plant technologies, Wartsila In Detail 02-2014 etc.
- [7] Dansk Fjernvarme and FDKV reports from CHP installations, the Dansk Fjernvarme information is from a 2012 survey for an earlier version of the report.
- [8] Ongoing Sulpur research project at DGC (MUDP).
- [9] AEA.dk
- [10] Danish Gas Technology Centre, Analysis on gas engine and gas turbine dynamics, 2013.
- [11] Blockheizkraftwerke 2013, M. Buller et al, GWF Gas Erdgas, Juni 2014.
- [12] Suppliers association information etc.
- [13] MAN Turbo Presentation of Gas Engine with fuel switch, 2012

07 CO₂ Capture and Storage

This chapter has been moved here from the previous Technology Data Catalogue for Electricity and district heating production from May 2012. Therefore, the text and data sheets do not follow the same guidelines as the remainder of the catalogue.

Brief technology description

In fossil fired power plants the CO₂ content in the flue gas varies between 3 and 15 per cent of total flue gas volume, depending on the type of fuel and power plant process.

CO₂ capture and storage (CCS) is best suited for large point sources of CO₂ such as power plants. The process involves three main steps:

1. Capture of CO₂.
2. Transportation to an injection sink.
3. Underground geological injection.

Several CO₂ capture systems are already available on a smaller scale, but generally they can be divided into three groups:

- Post-combustion capture
- Pre-combustion capture
- Oxy-fuel combustion

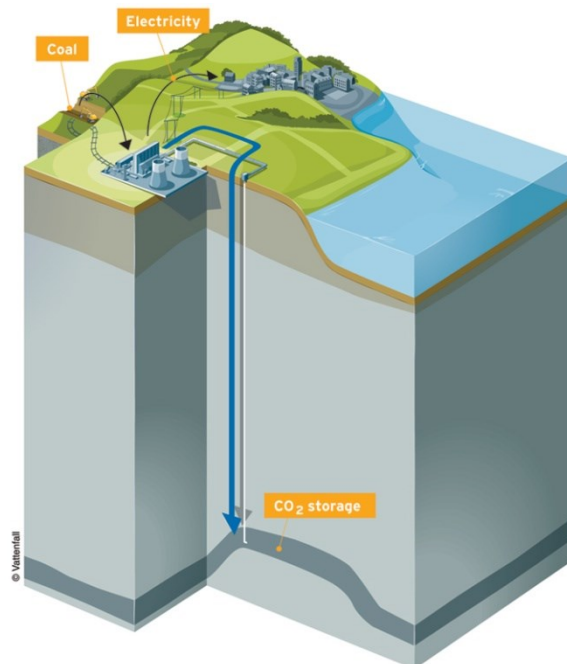

Illustration provided by Vattenfall (www.vattenfall.com).

Illustrator: www.kjell-design.com

In post-combustion capture the CO₂ is separated from the flue gas. Several technologies have been proposed. The dominant post-combustion technology is CO₂ capture by absorption in chemical solvents, like aqueous amine solutions, which is a commercial technology for some industrial purposes, but not yet for power plants. After the absorption the CO₂ is stripped from the solvent by raising the temperature, dried, compressed and transported to the storage.

Pre-combustion capture means that the CO₂ is removed prior to the actual combustion process in connection to coal gasification or decarbonisation of natural gas, which essentially produce hydrogen and CO₂. The hydrogen is then used as fuel. The removed CO₂ is compressed and transported to the storage.

In the Oxy-fuel approach the nitrogen in the air is removed prior to combustion and the fuel is combusted in an atmosphere of oxygen and recycled CO₂. The flue gas will only consist of water vapour and CO₂. The water vapour can easily be condensed giving a highly concentrated CO₂ stream, which can be compressed, purified and transported to the storage.

The major barrier for a broad use of CO₂ removal technology is the current high costs of separating and compressing the CO₂. The extra amount of energy required for this process typically reduces the overall efficiency by around 10 percentage points.

It is necessary to transport the captured CO₂ from the power plant to a location where it can be injected into a suitable (permanent) storage reservoir. This is believed to be feasible primarily by using pipelines, alternatively ships, similar to LPG tankers [1].

Relevant concepts for storage are either use of CO₂ for enhanced oil or gas recovery or storage in deep saline formations – either offshore or onshore. CO₂ is also utilised in the industry for manufacture of chemical products and in the food and drink industry, but due to the large amounts of CO₂ from power plants the only relevant utilisation is for enhanced oil or gas recovery [4].

Input

CO₂ in flue gas.

Output

Stored CO₂ and CO₂-lean flue gas.

Regulation ability

The regulation ability of a power plant is not influenced by adding post-combustion CO₂ capture. However, the CO₂ content in the flue gas decreases at part load, and thus the capture costs (in € per tonne) increases. Therefore, operating CCS power plants as base load plants may become the preferred option [4].

Research and development

Considerable research and development work is required in order to further develop and optimise techniques that reduce barriers for a wider use, i.e. to achieve greater efficiency, confidence and monitoring of storage, mitigation strategies (if there should be a leak), and integration of technologies that require scale and lower cost.

The European Commission supports RD&D on CO₂ capture and storage. The 7th Framework Programme for research, technological development and demonstration activities (2007-2013) intends to support about ten

demonstration plants. The key European stakeholders formed the Zero Emission Technology Platform (ZEP, www.zeroemissionsplatform.eu) in 2005.

Examples of best available technology

Examples of best available technology for capture projects are [4]:

- The Castor pilot plant at Esbjerg Power Station that cleans a 0.5% slip stream from the power plant using post combustion technology; operated by Dong Energy. The CO₂ is released after capture.
- The 30 MJ/s Oxyfuel pilotplant at Schwarze Pumpe Power Plant in Germany that demonstrates the oxyfuel technology; operated by Vattenfall.

In 2007, three large-scale storage projects (over 0.5 Mt injected per year) were in operation around the world [8]:

- Offshore in Norway Statoil is injecting CO₂ from the Sleipner oil field in the Utsira aquifer. The field has a special feature as the gas has a CO₂ content of around 9%, which must be reduced to 2.5% before it is sold. The CO₂ that is stripped from the gas is injected into a structure 800 metres below the seabed is around one million tonnes of CO₂ per year. Injection began in 1996. The injection and storage is intensively monitored and provides data to various projects.
- CO₂ is extracted from natural gas from the In Salah gas field in Algeria. The CO₂ is injected into a carboniferous reservoir containing water, underlying the gas producing zone.
- CO₂ is extracted from natural gas from the Snohvit gas field in the Barents Sea, Norway. The CO₂ is injected 2600 metres underneath the gas producing zone.

Additional remarks

The costs of CCS are often divided according to the three main steps of the process:

1. Capture of CO₂, including compression for transport.
2. Transportation to an injection sink.
3. Underground geological storage.

The bulk of the costs of CCS projects are associated with CO₂ capture. For the most cost effective technologies, total capture costs (capital plus O&M costs) are USD 25 to 50 per tonne of CO₂ emissions avoided, with transport and storage about USD 10 per tonne [8]. For typical European offshore settings the transport and storage cost is higher than this, and the variation from project to project is substantial [12].

Carbon capture technologies at the scale needed for power plants have not yet been demonstrated. Hence, most reported cost figures are only estimates, based on scaling up of smaller components used in other

industries or on manufacturers' expert judgement based on experience from other (near-) proven technologies. The accuracy of the resulting estimates usually lies within the range of $\pm 30\%$ [13].

CO₂ capture and compression consumes energy, which may result in additional emissions that must be taken into account when evaluating the impact and the cost-efficiency of CCS. The terms CO₂ capture cost and CO₂ avoidance cost are used for these two different evaluation methods.

Capture cost: Cost of capturing one tonne of CO₂.

Avoidance cost: Cost of reducing the CO₂ emission by one tonne, assuming same electricity generation.

For power plants, capture cost can be translated into avoidance cost based on the equation:

$$Cost(avoided) = \frac{Cost(captured) \cdot CE}{\frac{\eta_{new}}{\eta_{old}} - 1 + CE}$$

Where η_{new} and η_{old} are the electricity efficiencies of the power plants with and without CO₂ capture, and CE is the fraction that is captured. For example, if η_{new} and η_{old} are 35% and 43% and CE is 0.90, the cost ratio (avoided/captured) is 1.26.

Expressing CCS costs in terms of the cost per tonne of CO₂ avoided allows those costs to be directly compared with other CO₂ abatement measures in terms of the cost of the environmental effects that have been achieved.

As most coal-fired power plants have a long lifespan, any rapid expansion of CCS into the power sector would include retrofitting. The costs of retrofitting depend much on local circumstances:

- A case study from Norway has suggested that a retrofit would reduce efficiency by 3.3% more than a new integrated system [8]. The average cost of CO₂ avoided for retrofits is about 35 % higher than for new plants. Several factors significantly affect the economics of retrofits, especially the age, smaller sizes and lower efficiencies typical of existing plants relative to new builds. The energy requirement for CO₂ capture also is usually higher because of less efficient heat integration for sorbent regeneration [10].
- A case study from Denmark indicates that retrofitting results in very little additional costs and that the electricity efficiency is only marginally lower compared with new projects [4].

There are two main methods of CO₂ transportation [14]:

- Pipeline costs are roughly proportional to distance.

- Shipping costs are fairly stable over distance, but have ‘step-in’ costs, including a stand-alone liquefaction unit potentially remote from the power plant. The cost is less dependent on distance.

For short to medium distances and large volumes, pipelines are therefore by far the most cost-effective solution.

Pipeline costs may increase in congested and heavily populated areas by 50 to 100 % compared to a pipeline in remote areas, or when crossing mountains, natural reserves, rivers, roads, etc.; and offshore pipelines are 40 – 70 % more expensive than similar pipelines built on land [10].

References

1. Putting Carbon Back in the Ground, IEA Greenhouse Gas R&D Program, February 2001
2. CO₂ Capture and Storage in Geological Formations, by Jacek Podkanski, IEA 2003
3. CO₂ Capture at Power Stations and Other Major Point Sources, Jacek Podkanski, IEA 2003
4. Vattenfall, 2010.
5. Uncertainties in Relation to CO₂ Capture and Sequestration. Preliminary Results, Dolf Gielen, IEA/EET Working Paper 2003
6. The Future Role of CO₂ - Capture and Storage Results of the IEA-ETP Model, Dolf Gielen, 2003
7. www.ieagreen.org.uk
8. “Energy technology perspectives 2008”, International Energy Agency, 2008.
9. “CO₂ Capture and Storage. A key carbon abatement option”, the International Energy Agency, 2008.
10. “Carbon Dioxide Capture and Storage”, International Panel on Climate Change (IPCC), 2005.
11. “Carbon Sequestration Leadership Forum Technology Roadmap” (CSLF; www.cslforum.org), 2009.
12. DONG Energy, 2009.
13. "The Cost of Carbon Capture and Storage Demonstration Projects in Europe", JRC Scientific and Technical Reports, European Commission, 2009.
14. "The Costs of CO₂ Capture, Transport and Storage", Zero Emissions Platform (ZEP), July 2011.

Data sheets

JRC [13] made a thorough review and analysis of most recent (in 2009) cost assessments of CCS. As a unique feature, all assumptions are presented in the report. All data on this page are from this report.

The mentioned reference values are calculated by a weighted average of data from 13 reviewed reports, the weighting factors determined by the robustness of the reported figures.

The following capture technologies are included:

IGCC-CCS: Integrated Gacification (of coal) Combined Cycle with pre-combustion capture

PF-CCS: Pulverized Fuel (coal) with post-combustion capture

NGCC-CCS: Natural Gas Combined Cycle with post-combustion capture

Oxyfuel: Oxyfuel combustion with post-combustion capture

		IGCC-CCS	PF-CCS	Oxyfuel	NGCC-CCS
Electricity efficiency					
Low	%	32	29	35	45
High	%	35	43	41	47
Reference value	%	35	35	35	46

All plants have a net capacity of 400 MW, and all costs are in Euro 2008:

		Carbon capture			
		IGCC-CCS	PF-CCS	Oxyfuel	NGCC-CCS
Specific investment cost					
Low	M€/MW	1.835	1.641	2.122	0.937
High	M€/MW	3.241	3.710	4.279	1.766
Reference cost	M€/MW	2.7	2.5	2.9	1.3
Fixed O&M cost					
Low	€/MW/year	60000	42000	44000	27000
High	€/MW/year	86000	80000	104000	56000
Reference cost	€/MW/year	75000	65000	90000	38000
Variable O&M cost					
Low	€/MWh	1.6	3.7	0.1	0.6
High	€/MWh	2.9	5.8	3.6	1.2
Reference cost	€/MWh	2.1	4.5	0.9	0.9
		CO2 transport and storage			
Low	€/tonne	5			
High	€/tonne	40			
Reference cost	€/tonne	20			

JRC calculated the costs of CCS plants including pipelines and storage compared to reference state-of-the-art conventional plants that use the same fuel and are of the same net electricity output. The average costs per

tonne of CO₂ avoided for the coal-fired CCS plants and the NGCC-CCS plant were 87 €/t and 118 €/t respectively.

The below table, in the same format as other technologies in this report, has been developed using other sources than the above-referenced JRC-report.

Technology	CO ₂ capture (post-combustion), pulverized coal power plant					
	2010	2020	2030	2050	Note	Ref
Energy/technical data						
Generating capacity for one unit (MW)	500 - 740					1+2+3+4
Capture efficiency (%)	90	90	90	90	A	1
Generation efficiency decrease (%-points)	8-10%	8-10%	8-10%	8-10%	B	1+2+3
Financial data						
Capture, post-combustion						
Nominal investment (M€/MW)	2.3-4.3	3.07	3.00	2.86	C	1+2+3+4; 2;2;2
Fixed O&M (€/MW/year)	72000-87000	72000-87000	72000-87000	72000-87000	D	1+2
Variable O&M (€/MWh)	3.4-4.1	3.4-4.1	3.4-4.1	3.4-4.1	D	1+2

References:

- 1 "The Costs of CO₂ Capture, Transport and Storage", Zero Emissions Platform (ZEP), July 2011
- 2 "UK Electricity Generation Costs Update", Mott MacDonald, June 2010.
- 3 "Energy Technology Perspectives", IEA 2010
- 4 "ProjectCosts of generating Electricity", IEA & NEA, 2010

Notes:

- A The non-captured CO₂ is released into the atmosphere.
- B Some of the electricity consumption may be regained as useful heat. The displayed efficiency decreases do most probably take the usage of heat into account.
- C The nominal investment is per net generating capacity, i.e. after deducting the power consumed for CO₂ capture. If you compare two power plants, with CCS (this element) and without CCS (element 01), and with the same net power generating capacity, the difference in nominal investment (e.g. 3.07-2.03 = 1.04 M€/MW in 2020) is the value of the capture equipment. If CO₂ capture is added on to an existing power plant, the loss in generating capacity shall be taken into account.
- D The O&M costs are per net generating capacity and net generation, i.e. after deducting the power consumer for CO₂ capture.

The ZEP report [14] is probably the most complete analysis of CO₂ transport costs to date. The report describes three methods of transportation and for each of these present detailed cost elements and key cost drivers. The three methods are:

- Onshore pipeline transport
- Offshore pipeline transport
- Ship transport, including utilities.

The following table shows the unit transportation cost (EUR/tonne) for such projects, depending on transport method and distance, and with typical capacities in million tonnes per annum (Mtpa):

Typical capacity of 2.5 Mtpa, 'point-to-point' connections					
Distance	km	180	500	750	1500
Onshore pipe	€/tonne	5.4	n.a.	n.a.	n.a.
Offshore pipe	€/tonne	9.3	20.4	28.7	51.7
Ship	€/tonne	8.2	9.5	10.6	14.5
Liquafaction (for ship transport)	€/tonne	5.3	5.3	5.3	5.3
Typical capacity of 20 Mtpa, 'point-to-point' connections					
Distance	km	180	500	750	1500
Onshore pipe	€/tonne	1.5	3.7	5.3	n.a.
Offshore pipe	€/tonne	3.4	6.0	8.2	16.3
Ship (including liquefaction)	€/tonne	11.1	12.2	13.2	16.1

The ZEP report [14] also provides an update on storage costs:

Case			Cost range (€/tonne CO2 stored)		
			Low	Medium	High
Onshore	Depleted oil and gas fields	Existing well	1	3	7
Onshore	Depleted oil and gas fields	New well	1	4	10
Onshore	Saline aquifer	New well	2	5	12
Offshore	Depleted oil and gas fields	Existing well	2	6	9
Offshore	Depleted oil and gas fields	New well	3	10	14
Offshore	Saline aquifer	New well	6	14	20

Introduction to Waste and Biomass plants

Due to large similarities the qualitative description of biomass and waste fired plants are presented with a common technology description. Also, the chapters describing combined heat and power (CHP) and heat only plants (HOP) for biomass and waste respectively have been merged in an effort to make the catalogue easier to read.

Contact information

Danish Energy Agency: Rikke Næraa/Filip Gamborg
Author: Rambøll: Claus Hindsgaul, Tore Hulgaard
Reviewer: Niels Houbak

Publication date

March 2018

Amendments after publication date

Date	Ref.	Description
September 2018	Introduction, biomass and waste sections	Version 3: Updated introduction to waste and biomass and merging of CHP and HOP descriptions for waste and biomasse respectively.

Qualitative description

Brief technology description

The description includes technologies that have large similarities when used for CHP and HOP fired with biomass or waste, the latter named Waste-to-Energy (WtE) facility. The main systems are presented in Figure 9, illustrated by a WtE CHP facility.

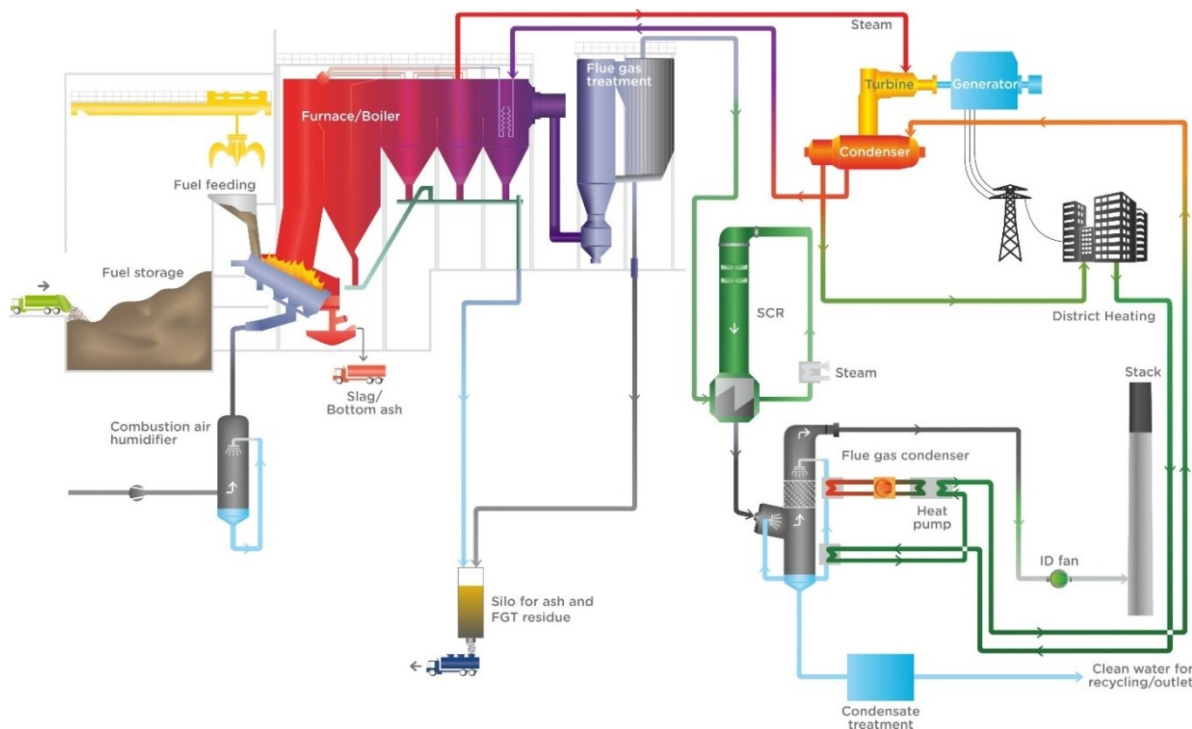

Figure 1 Main

systems of a CHP (or Heat only) facility, example WtE CHP facility

The main systems of a biomass or waste fired CHP plant are:

- Fuel reception and storage area,
- Furnace or firing system including fuel feeding
- Steam boiler
- Steam turbine and generator,
- Flue gas treatment (FGT) system potentially including a SCR-system for NO_x reduction
- Systems for handling of combustion and flue gas treatment residues
- Optional flue gas condensation system
- Optional combustion air humidification system

In case of HOP, the steam boiler is replaced with a hot water boiler, and no turbine/generator set is included. Other main systems are in principle the same as for the CHP-plants. New Danish plants with a heat capacity >1 MW are currently imposed to be designed as CHP [6]. This requirement for combined heat and power production is debated and changes in legislation must be checked up on.

Input

Wood chips, wood pellets and straw are considered for biomass plants. Other types of biomass e.g. other forest residues; sawdust and nut shells may be relevant as energy source, while different fuels set different technical requirements for the plant, these differences will not be adressed.

Waste to energy (WtE) facilities receive non-recyclable municipal solid waste (MSW), commercial waste and certain fractions of industrial waste and construction & demolition waste. It may also include refuse derived

fuel (RDF), for instance imported from the United Kingdom. Certain types of hazardous waste may be included but dedicated hazardous waste plants are not covered here. More on fuel follows in the respective chapters on WtE and biomass.

Fuel reception and storage

The fuel is received by ship or lorry. Storage is usually available on site for a minimum of two days full load operation. For wood chips and wood pellets the fuel storage will typically have a capacity of 1-2 weeks. Straw is received in bales and stored in an enclosed building in order to avoid exposure to moisture, wood pellets are stored in a closed silo, wood chips may be stored outside, but often under roof to limit exposure to rain. The investment costs in the datasheets include two days' storage, only. In many cases the optimal fuel storage capacity would be larger. Therefore, specific cost of fuel storage per day in excess of 2 days is listed separately in the datasheet.

Waste is received and stored in a closed building to avoid escape of odour and it is unloaded into a dedicated bunker from where a grab brings it to the feeding hopper. The bunker would usually be sized for 4 days of operation.

Furnace

The furnace is where the fuel is injected, dried, pyrolysed and burnt and the energy content is converted to hot flue gas for subsequent uptake in the boiler. The typical furnace technologies can be divided into: grate firing, different types of fluidised beds (FB) and suspension firing (where the fuel is pulverized or chopped and blown into the furnace, optionally in combination with a fossil fuel).

Grate combustion is a well-established and robust technology with regard to using different types of biomass. There are examples of combined boiler technologies with both suspension- and grate firing. For geometrical reasons there is a limit to how big a grate fired plant can be constructed – of the order slightly below 200 MW thermal input.

Only a few biomass FB boilers exist in Denmark. Large FB boilers are of the type Circulating Fluid Bed (CFB) and they are typically used for CHP plants in situations where the plant size exceeds the maximum for grate firing. In particular wood chips is an excellent fuel for FB boilers.

Alternatively, suspension firing is suitable for very large biomass power plants (substantially above 200 MW thermal input) and it requires a pulverisation of the fuel before it is fed into the furnace. Pulverisation of biomass is not an easy task but in particular pellets can be disintegrated into its finer particles using a (coal) mill. These particles are often adequate directly for combustion.

WtE facilities in Denmark are all grate fired. At WtE plants an afterburning chamber ensures that temperature and residence time requirements are met. During boiler start-up biomass or auxiliary burners in the furnace fired by oil or gas are needed to ensure heating to the required temperature. During normal operation, no auxiliary fuel is added.

Boiler

The boiler is where the energy content of the flue gas is transferred by heat exchange to the heat media, which is usually hot water and in case of CHP, water and steam. As flue gas passes through the boiler, it is cooled, and the heat media is heated by heat exchange. In a heat only boiler, water is heated to supply the necessary district heating (DH) supply temperature, which is typically up to 90°C in Denmark for distribution networks and somewhat higher when the DH water is led to the transmission networks.

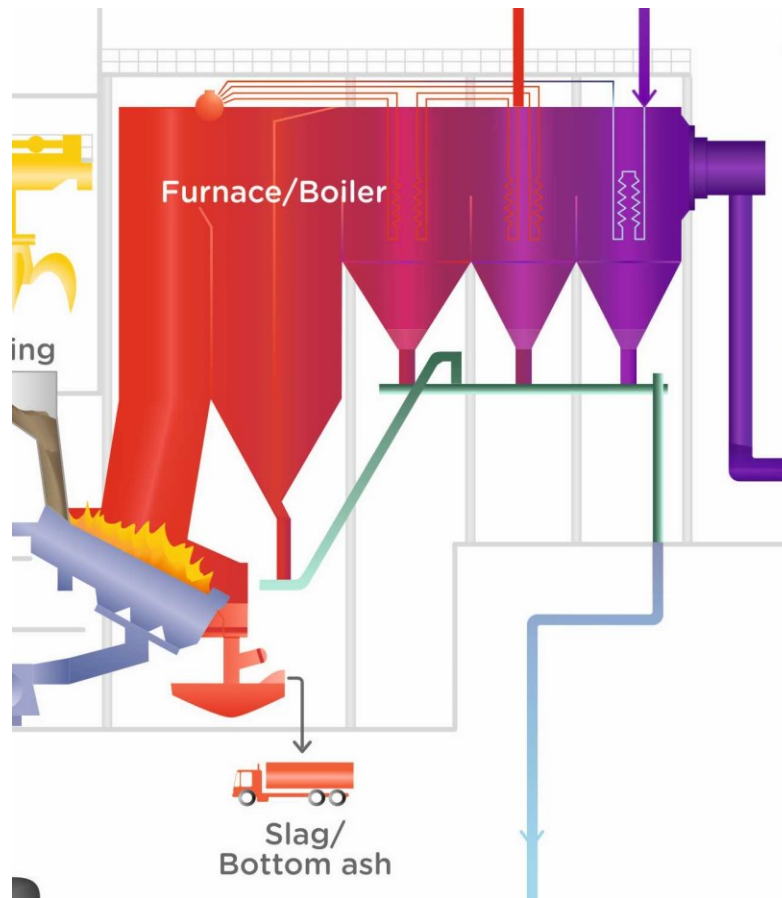

Figure 2 Furnace/boiler system

The output from the boiler of a CHP facility is superheated steam, i.e. steam that is heated above the boiling point. The plant includes feed water pumps supplying high pressure water to the boiler, an economiser, where the input water is heated towards the boiling temperature, evaporators, where the water is evaporated to steam, a drum vessel for separation of steam and water, and super heaters, where the steam is heated above the boiling temperature. Large biomass facilities may use different boiler types.

Turbine/generator

The turbine/generator set is only included in CHP (or power only) facilities. The superheated high-pressure steam from the boiler is led to the turbine where the energy content of the steam is converted to rotation energy in the turbine. Through its connection to the generator, the rotation energy is converted to electricity.

The temperature and pressure of the steam decrease as the steam drives the rotation of the turbine blades. The low-pressure steam is extracted from the turbine to DH condensers at the pressure and temperature levels that suit the requirements of the DH network. The condensation heat is delivered to the DH network. This is different from a power-only facility where condensation happens at lower temperatures and the heat of condensation is wasted, e.g. in an air-cooled condenser. The power efficiency of a CHP facility is therefore lower than the corresponding power-only facility, but the total efficiency is much higher. Power-only facilities are not included in the present technology sheets.

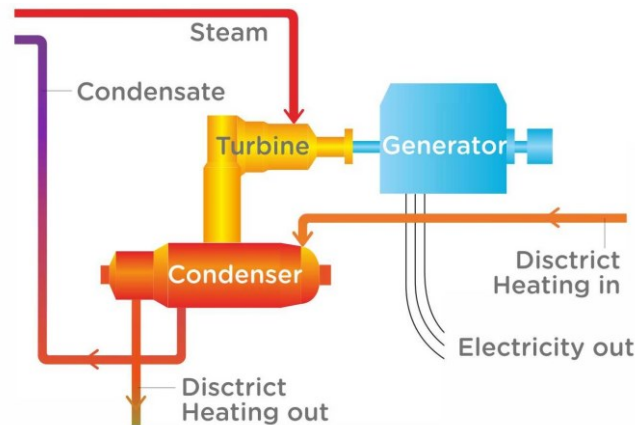

Figure 3 Turbine/generator system

Flue gas treatment (FGT)

The flue gas is treated to meet the emission requirements of biomass and waste, respectively. The FGT always includes a particle filter, either an electrostatic precipitator (ESP) or a bag house filter (BHF). Acid gases (HCl, SO₂ and HF) are mitigated in a dry process by injection of hydrated lime, for subsequent capture in a BHF, or in a wet scrubbing system. Using a wet scrubbing system reduces the amount of solid residue, but effluent water must be treated before discharge to meet stringent emission levels. In WtE dioxin and mercury may be captured by injection of activated carbon.

NO_x is mitigated by the SNCR or SCR process (SNCR and SCR are Selective Reduction of NO_x by ammonia injection, by the respective Non-Catalytic or Catalytic process). The SNCR process works by injection of ammonia in the furnace at around 900°C. It has limited efficiency, and to meet stringent emission limit values it may be necessary to install the highly efficient catalytic SCR system. With biomass and waste an SCR system would usually be located downstream of the main FGT (tail-end) or at least downstream the particle filter to avoid that certain elements in the flue gas deactivate the catalyst.

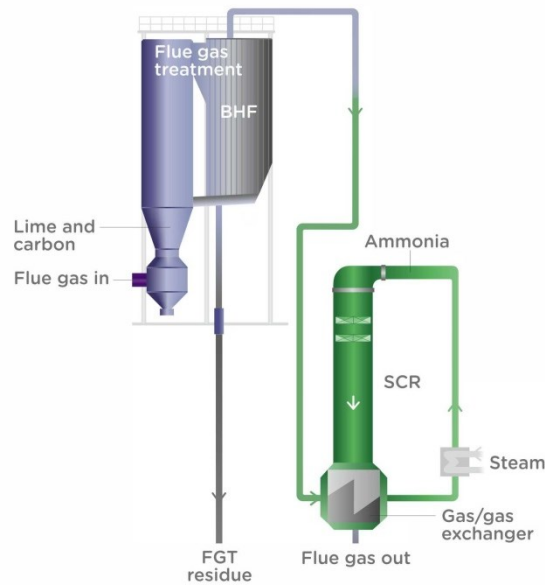

Figure 4 Flue gas treatment system (dry/semi-dry) including reactor with injection of hydrated lime, a bag house filter and an SCR system with gas/gas heat exchanger, steam reheater, ammonia injection and catalyst.

Handling of solid residues

Solid residues include incombustible matter (ash) and flue gas treatment (FGT) residues. With biomass most of the ash is segregated in the boiler or particle filter and collected in a silo for disposal together with the FGT residue. In case of WtE the ash makes up 15-20% of input waste, and around 90% thereof leaves the facility as bottom ash, segregated from the furnace grate.

Flue gas condensation system

The flue gas condensation system is installed for increased heat recovery primarily through condensation of the water vapours of the flue gas. The energy efficiency could thereby be increased by more than 20%-point. Flue gas condensation is currently customary in WtE facilities and biomass fired facilities, particularly when using wood chips, waste, and similar relatively wet fuels.

Flue gas condensation may be arranged as a wet scrubbing system (Figure 13) in which the scrubbing liquid is cooled by heat exchange with DH water. The relatively cold DH water cools the scrubber and it is thereby heated. When the cooled scrubbing liquid meets the warmer flue gas that has been saturated with water vapour, the vapour condenses, thereby releasing the heat of condensation. The condenser may also be arranged with flue gas running in vertical tubes exchanging heat with DH water surrounding the tubes or plate heat exchangers in the flue gas path. The flue gas condensation system may be divided into two systems. First stage is direct condensation where heat recovery happens by direct heat exchange with DH water and in the second stage condensation is assisted by heat pumps. The heat recovery by direct condensation is limited by the DH return temperature. The lower the temperature, the higher the heat recovery. The heat pump allows cooling the flue gas and condensation of water vapour to quite low temperature (20-30°C), corresponding to very high energy recovery at the expense of driving energy for the heat pump (typically steam or electricity).

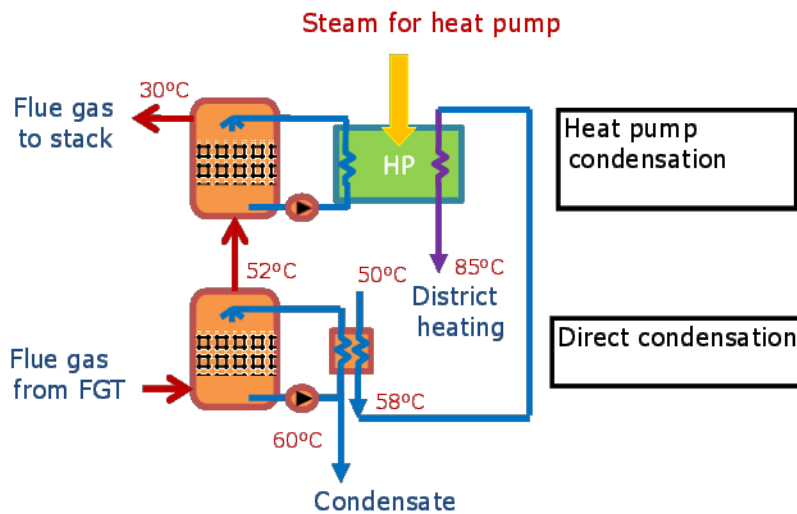

Figure 5 Flue gas condensation, direct and heat pump driven with 50°C DH return temperature, and typical WtE adiabatic scrubber temperature of 60°C.

In the datasheets, only direct condensation is included to the level limited by the DH return temperature of 40°C. The heat pump condensation potential is listed separately (“Additional heat potential for heat pump (%)”), and not included in the listed efficiencies. Section 0 below describes how to quantify the total efficiency for a biomass or WtE facility with flue gas condensation given a specific fuel and DH temperature.

Running the flue gas through several wet scrubbers of the flue gas condensation system contributes to reaching very low emissions of HCl, SO₂, dust, heavy metals and ammonia.

Condensate and wastewater treatment

Process waste water from a wet scrubber (if included) must be treated prior to discharge to the sewage system or the sea. In any case stringent requirements apply, governed for instance by [7]. Treatment includes neutralisation, precipitation of heavy metal ions and filtering, and generation of a small amount of sludge.

Condensate from flue gas condensation has low content of salts and pollutants when the condensation system is located downstream the FGT-system. Condensate treatment includes reverse osmosis to yield very clean water useful for industrial applications including boiler make-up water and make-up water for the DH network. The net water production may significantly exceed the original fuel moisture content, due to water formed from hydrogen and oxygen during combustion. For relatively wet fuel the excess water may be more than 500 kg per tonne of fuel input.

Combustion air humidification system

Combustion air humidification may to some extent substitute the use of heat pump driven condensation for increased heat production. Combustion air humidification works by adding water vapour to the combustion air, thereby increasing the content of water vapour in the flue gas as it enters the flue gas condensation system, in turn increasing the heat output of the direct flue gas condensation. The energy needed to generate the water vapour input to the combustion air is recovered from the last stage of the flue gas condensation system, at the

temperature level below the DH temperature. This low temperature heat, at e.g. 50°C, is used as heat source for evaporation of water in the combustion air humidification system.

The high-level effect of combustion air humidification is that the flue gas is cooled further than it is possible by heat exchange with the DH water, thereby representing an increase in energy recovery from the fuel. In the data tables it is assumed that combustion air humidification (if included) reduces the flue gas condensation temperature by 5°C and 8°C at DH return temperatures 40°C and 50°C, respectively. Currently no WtE facilities in Denmark are equipped with air humidification, but the system is customary in biomass fired facilities having flue gas condensation.

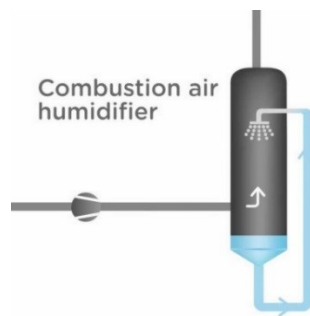

Figure 6 Combustion air humidifier, where water heated by a low-temperature source is evaporated into the combustion air flow.

The energy model for the technology datasheets

A new approach has been introduced to generate the data tables for the biomass and waste combined heat and power (CHP) and heat only plants in this version of the datasheets. Due to the technological similarities, a common model has been used to populate the sheets for biomass and waste. This ensures a better consistency of the data spanning many scenarios and feedstocks. It is believed that this will eliminate skewness caused by interpretation of reference data and differences in conditions for the reference plants, such as fuel and DH infrastructures.

The energy efficiency estimates in the datasheets were calculated using a thermodynamic model of flue gas energy recovery to steam and DH, including flue gas condensation [4]. A steam cycle model estimated the steam-to-power efficiency based on the steam parameters and turbine sizes. The same models were used to estimate efficiencies for the datasheets covering heat only and CHP plants for WtE as well as biomass plant types at all size ranges. The different performances are thus a consequence of different plant design data assumed in each case and the fuel properties.

Table 1 shows the basis plant design assumptions made for the “2015” scenarios for different feedstocks. Conservative and optimistic variations of these assumptions were made to produce the future, “Upper” and “Lower” performance data. For example, “Lower” WtE models would assume steam at 400°C/40bar and no combustion air humidification, while “Upper 2050” assume 500°C/90bar, which will require advances in the technology. For small-to-medium biomass plants, “Upper” models assume the lower excess air offered by the Dall boiler already today etc.

Fuel	Waste	Wood chips	Wood pellets	Straw
Firing system	Grate	Grate/ CFB (large)	Suspension	Grate
Live steam, CHP	425°C/50 bar	540°C/90 bar	560°C/90 bar	540°C/90 bar
Flue gas temperature after steam boiler	160°C	130°C	130°C	130°C
Excess air ratio	1,5	1,3	1,3	1,3
Boiler losses other than flue gas (% of LHV)	2%	2%	2%	2%
Turbine losses (gear/generator) (% of gross power), CHP	3%	3%	3%	3%
Flue gas condensation	Yes	Yes	Yes	Yes
Combustion air humidification	No	Yes	Yes	Yes
Flue gas cleaning type	Wet	Dry	Dry	Dry
NOx abatement (small and medium size)	SNCR	SNCR	SNCR	SNCR
NOx abatement (large facilities)	SNCR	SNCR	SCR	SCR

Table 1 Base assumptions for “2015” model CHP plants for energy performance estimation.

The total efficiency of plants with flue gas condensation is calculated assuming “direct condensation”, where the condensation heat is recovered directly with the available DH water without the use of heat pumps.

DH plants share base assumptions with the CHP plants, except that live steam parameters are not applicable, and the turbine losses do not exist for these plants.

At some plants, condensation heat recovery is augmented by cooling the flue gas further, typically to 30°C using heat pumps. In the datasheets, the row “Additional heat potential for heat pump (%)” contains the additional heat that a heat pump would recover from the flue gas by cooling it further to 30°C. The so produced additional heat is the sum of this recovered amount of heat and any external driving energy (electricity or steam) supplied to drive the heat pump. The efficiencies listed in the data tables do not include the contribution from heat pump driven condensation, and the heat pump investments are not included in the listed investments.

As an example, the plant Amager Bakke would belong to the “Large WtE” plants with high DH temperature levels of 50/100°C. The 2015 data from the datasheets provide name plate values of 21.1% for power and 74.4% for heat, summing up to 95.5%. The additional heat from heat pumps is given as 10.0%, increasing the sum to 105.5%.

Without heat pumps, the actual design power efficiency of 25% at Amager Bakke is higher than the 21.1% that the tables suggest. This is mainly due to the high steam parameters (440°C/70bar), and the lower forward temperature of the actual DH water (85°C instead of the 100°C assumed in the tables). The total design efficiency is 95% without using heat pumps, which is on level with the 95.5% from the tables.

With heat pumps activated, the total efficiency at Amager Bakke reaches 107%. This is slightly higher than the 105.5 % in the tables, which is due to the flue gas being cooled to 20 °C instead of 30 °C, and some additional component cooling heat recovery is performed by the installed heat pumps as well. The power efficiency is reduced to 22.5% when using the heat pumps, mainly due to the transfer of driving steam for the heat pumps. The system coefficient of performance (COP) of the heat pump system is estimated at around 5.5, meaning that 5.5 MWh of heat is generated for one MWh reduction of electricity production.

The loss of power production caused by the steam consumption of the heat pumps is system specific and cannot be tabulated here. If electrically driven heat pumps had been used instead, the power production loss would be avoided, but instead the heat pump would consume power themselves. Please refer to the heat pump technology sheets for more information.

Total energy efficiency determination with flue gas condensation

Flue gas condensation is a technology that can significantly increase the heat efficiency of biomass and WtE plants by recovering the heat of condensation from water vapour in the flue gases. It is now implemented at the majority of the WtE plants (more than 70% of the installed capacity in 2018, [5]) and at most biomass plants in Denmark.

The heat of condensation is not included in the heating value definition of the lower heating value, LHV, which is usually used in Europe as basis for defining the energy input. Thus, total efficiencies based on LHV at plants with flue gas condensation may exceed 100%. Further the total efficiency of such plants can vary significantly for different fuels with different compositions and moisture contents when using the LHV as the basis.

For flue gas condensation the relevant heating value definition to describe the heat recovery and the total plant efficiency is the higher heating value (HHV), which takes into account the energy recovery potential from condensation. Thus, we will in the specific section below need to make references to the HHV. The rest of the technology data sections as well as all the data tables will refer to the usual LHV only. The total HHV-based efficiency of a given plant with flue gas condensation is almost the same for any fuel, when the flue gasses are cooled, and water vapour condensed to a certain temperature. The total HHV-based efficiency with flue gas condensation depends mainly on the temperature of the DH return water, which is used to recover the low temperature heat through heat exchange.

Figure 15 shows the HHV-based total gross efficiency for typical biomass plants and WtE plants. This curve is generally applicable to such plants, for CHP as well heat only configurations. Biomass plants with flue gas condensation have slightly higher HHV-based gross efficiencies because they typically operate with lower excess air ratios than WtE plants. The dashed boiler efficiency indications in Figure 15 show the no-condensation lower efficiency limit, which is fuel specific. Wood chips were selected for the example to give a low lower limit.

Total HHV-based efficiency, flue gas condensation

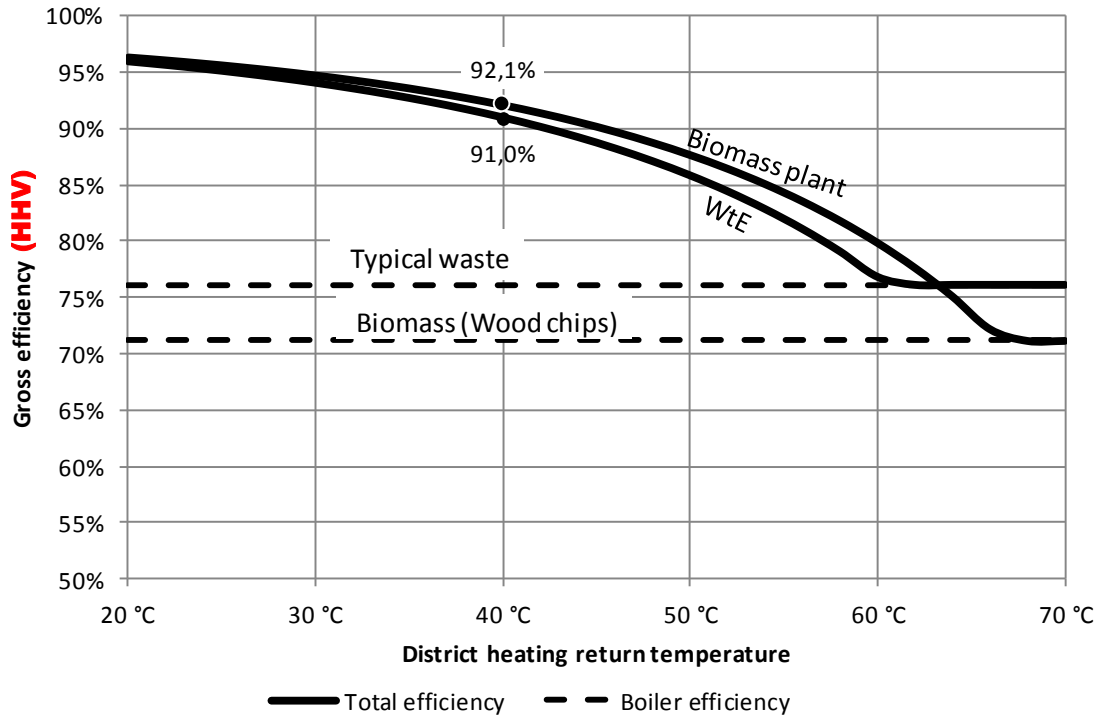

Figure 7. Total HHV-based efficiency estimate for WtE plants⁷ and biomass plants⁸ given varying DH return temperatures [5] – or temperature of the cold media of a heat pump.

Figure 15 can be used generally with good accuracy to estimate the total efficiency (based on HHV) of a WtE or solid biomass plant equipped with flue gas condensation, based only on the available DH return temperature. The estimate is even valid for marginal efficiencies of single waste fractions such as organic waste, paper, plastics etc. The conversion to the usual LHV-based total efficiency is straight-forward. As an example, typical municipal solid waste with a LHV of 10.6 MJ/kg and a HHV of 12.2 MJ/kg treated at a plant with flue gas condensation fed with 40°C DH water would according to Figure 15 have a total efficiency of 91.0% based on HHV. This can be calculated to the LHV-based gross total energy efficiency as: $91.0\% \cdot \frac{12.2 \text{ MJ/kg}}{10.6 \text{ MJ/kg}} = 104.7\%$. This value can be found in the WtE “2015” tables. For wet organic waste with a HHV of 6.5 MJ/kg and LHV of 4.4 MJ/kg treated at the same plant, gross total energy efficiency would be $91.0\% \cdot \frac{6.5 \text{ MJ/kg}}{4.4 \text{ MJ/kg}} = 134.9\%$. Table 2 shows examples of gross total efficiencies calculated the same way for different fuels at WtE and biomass plants connected to DH networks with return temperatures of 50, 40 and 30°C.

Gross total efficiencies with flue gas condensation	Heating value	Total efficiency (LHV)
---	---------------	------------------------

⁷ Assumptions for WtE: Excess air ratio $\lambda=1.5$. Ash content 25% of dry matter. Flue gases cooled to 2°C above the DH return temperature.

⁸ Assumptions for biomass: Excess air ratio $\lambda=1.3$. Wood chips with an ash content of 2% of dry matter. Flue gases cooled to 2°C above the DH return temperature.

Fuel or fuel fraction	LHV [MJ/kg]	HHV [MJ/kg]	DH	DH	DH
			50°C	40°C	30°C
WtE configuration HHV boiler efficiency (from Figure 7)			85.8%	91.0%	94.1%
Mixed waste 10.6 GJ/t (31% moisture)	10.6	12.2	98.8%	104.7%	108.3%
Organic waste (70% moisture)	4.4	6.5	127.3%	134.9%	139.5%
Green waste (50% moisture)	9.5	11.5	103.4%	109.6%	113.3%
Paper	11.1	12.6	97.4%	103.3%	106.8%
Plastic	35.0	37.5	91.9%	97.5%	100.8%
Biomass configuration HHV boiler efficiency (from Figure 7)			87.7%	92.1%	94.7%
Wood chips (50% moisture)	8.1	10.0	107.7%	113.1%	116.3%
Wood chips (40% moisture)	10.3	12.0	102.5%	107.7%	110.8%
Wood pellets (5% moisture)	17.7	19.0	94.3%	99.0%	101.9%
Straw (11% moisture)	15.0	16.4	95.8%	100.6%	103.5%

Table 2 Gross total efficiencies for different fuels at biomass and waste fired plants with access to different DH return temperatures using flue gas condensation.

At some plants, large heat pumps have been installed to supply condenser cooling water at even lower temperatures than the DH return temperature in order to further increase the heat recovery. In these cases, the total efficiency can still be read from Figure 15 by replacing the DH return temperature on the x-axis by the (lower) chilled water temperature from the heat pump. The use of a heat pump to extend the flue gas condensation is considered an add-on, the feasibility of which is judged as a separate project (cf. technology sheets on heat pumps). The heat pump constitutes most of the necessary additional investment.

Even higher total efficiencies can be achieved by recovering the heat from component cooling at the plant, which is usually lost. This would require the use of heat pumps. Recovery of component cooling energy is being implemented both at the WtE plants Amager Bakke and Fjernvarme Fyn in Odense during 2017, both reaching total net total efficiencies around 105-110 %.

All efficiencies in the main data tables of all ENS technology data sheets are given based on the usual LHV basis for the specifically assumed waste and biomass composition. Given other waste or biomass compositions, the total efficiency at plants with flue gas condensation is much more accurately estimated using the table or

procedure described above with the given fuel. The power efficiency should however be taken directly from the technology data sheets, as it is not significantly affected by flue gas condensation.

1.1 References:

- [1] Dansk Fjernvarme, Input and comments 2015, 2017, not published
- [2] ARC, Kirstine Hansen, Email 2015-05-07.
- [3] Vestforbrænding I/S, Grønt regnskab (Green accounts) of 2013 and 2015, respectively. Available at <http://www.vestfor.dk/Om-Vestforbraending/Nogletal> (last visited 01.08.2018).
- [4] Veronica Martinez-Sanchez, Tore Hulgaard, Claus Hindsgaul, Christian Riber, Bettina Kamuk, Thomas F. Astrup; Estimation of marginal costs at existing waste treatment facilities, Article in Waste Management 50, p 364-375. March 2016.
- [5] Ramboll, internal statistics and calculations. Not published.
- [6] Danish Energy Agency, Second act of project evaluation for district heating, §11. Available at <https://www.retsinformation.dk/Forms/R0710.aspx?id=183229> (last visited 01.08.2018).
- [7] Danish environmental protection agency, Tilslutning af industrispildevand til offentlige spildevandsanlæg, Vejledning fra Miljøstyrelsen Nr. 2 2006 (guideline on connection of industrial wastewater to municipal wastewater treatment facilities, in Danish), <https://www2.mst.dk/udgiv/publikationer/2006/87-7052-055-0/pdf/87-7052-055-0.pdf>.

08 WtE CHP and HOP plants

Contact information:

Danish Energy Agency: Rikke Næraa/Filip Gamborg

Author: Claus Hindsgaul, Tore Hulgaard, Rambøll

Publication date

March 2018

Amendments after publication date

Date	Ref.	Description
September 2018	08 Waste CHP and HOP	Updated qualitative description and merging of CHP and HOP descriptions

Qualitative description

Brief technology description

WtE plants incinerate waste and produce energy. HOP's produce only heat, while CHP's also produce electricity.

Flue gas condensation technology was introduced at WtE plants in Denmark in 2004 and has been installed in every new built WtE line in Denmark since 2007. It recovers the heat of condensation of the flue gas content of water vapour. The heat i.e. recovered as low temperature heat and thereby increases the energy efficiency by additional 10-25%-points for mixed waste.

Common technology description for biomass and WtE is found in Introduction to Waste and Biomass plants. Also, flue gas condensation, combustion air humidification, fuels and an improved energy model for technology data is described there.

Input

The fuels used in WtE plants include mainly municipal solid waste (MSW) and other combustible non-recyclable wastes. Biomass may be used mainly for starting up and closing down. Some plants in Denmark are feeding green waste from gardens and parks and challenging forest residues such as stubs. In addition, imported Refuse Derived Fuel (RDF) may be used as fuel. Other fuels include gasoil or natural gas for burners used mainly for start-up.

The fuel, waste, is characterised by being heterogeneous having large variation in physical appearance, heating value and chemical composition. The heating value of the waste fed to the furnace is a result of controlled mixing of available waste sources fed to the bunker of the WtE facility. It is usually in the range 7-15 MJ/kg, typically averaging 10-11 MJ/kg, referring to the lower heating value, LHV. For instance, the average heating value was 9.5 MJ/kg varying from 8-11 MJ/kg in 2014 in the WtE facility owned by Amager Resource Center

(ARC) in the Copenhagen area. At the time ARC had about 50% waste from trade and industry, which is a high ratio in Denmark [2].

The table below shows the trend of the heating value at Vestforbrænding I/S – the largest MSW plant in Denmark, and also located in the Copenhagen area.

Year	2011	2012	2013	2014	2015
MJ/kg	10.32	10.30	9.80	10.0	10.4

Table 1 Development of lower heating value at Vestforbrænding, Denmark. [3]

The heating value of the waste received at the WtE plants may be affected by increased focus on recycling, which on one hand may divert organic waste with relatively low heating value and on the other hand divert plastics, paper and wood with relatively high heating value. Many Danish WtE plants are importing RDF waste with relatively high heating value.

Output

The products from WtE CHP plants are electricity and heat as steam, hot (> 110°C) or warm (< 110°C) water.

The output from WtE HOP is hot water for district heat or low-pressure steam for industrial purposes. The energy efficiency of the WtE plant has increased over the last decade, driven by focus on combustion control, limiting the flue gas temperature at boiler exit and the excess air level, assisted by the increased use of flue gas condensation [7] and [8]. The total energy efficiency is identical for heat and CHP plants, except that for HOP some minor heat losses in the generator and turbine gearbox of the CHP plant is avoided. The heat production from a HOP is thus identical (or slightly higher) than the sum of produced electricity and heat from an equivalent CHP plant.

In case of flue gas condensation, excess condensate (which represents up to 50% of mass input of waste) may be upgraded to high quality water useful for technical purposes such as boiler water or for covering water losses of the district-heating network.

Typical capacities

The capacity of a WtE plant is typically in the range 10-35 tonnes of waste per hour, corresponding to a thermal input of approx. 30 - 110 MW. The furnace capacity is limited to around 120 MW thermal input at the current state of development.

WtE HOPs are typically relatively small with a capacity of 5-15 tonnes of waste per hour, corresponding to a thermal input in the range 15-50 MW.

The initial costs for WtE CHP plants are so high that smaller plants (< 5-10 t waste/h) are rarely financially attractive. The typical production line has a capacity of 10-35 t waste/h. More lines are installed if required. In Scandinavia WtE plants are typically located close to larger cities with a district heating system and they are designed to treat the waste amounts produced in the vicinity. During periods where local waste generation is below the treatment capacity, it is possible to supplement with waste from other regions, including imported

waste (as RDF). The size of the moving grate defines the upper limit waste mass capacity for each boiler line (approximately 40 t waste/h).

Regulation ability and other power system services

The CHP plants can be down regulated to about 70 % of the nominal capacity. Below the limit the boiler may not be capable of providing adequate steam quality and compliance with the requirement of high temperature residence time of the flue gas, cf. environmental section. WtE plants are preferably operated as base load due to high initial investments and that longer term storage of some types of waste is problematic and therefore it must be incinerated continuously. This also ensures continuous district-heating supply. In order to be able to maintain a waste treatment capacity (and heat supply) during outages WtE plants are sometimes built as 2 (or more) parallel lines instead of one large unit depending on alternative disposal options of waste.

Most CHP facilities are constructed with fully flexible and fast reacting electricity production meaning that the turbine may be taken in or out of operation through the use of a turbine by-pass, which may also be used partly. When the turbine is out, the output is 100% heat for district-heating, and furnace/boiler operation continues unaffected. Turbine operation can usually be maintained down to around 15% of nameplate load.

Advantages/disadvantages

A WtE plant is not just an energy producing unit but a multi-purpose facility. Main purpose is the treatment of waste by which the waste is sterilised, and its mass and volume are greatly reduced. Compared to landfilling and anaerobic digestion the WtE prevents emissions of methane, a powerful greenhouse gas, from the waste handling.

Recovery of energy from waste is a main feature for resource recovery as part of the circular economy system for waste. It provides the opportunity of recovering resource from wastes that are not recyclable, e.g. contaminated waste, rejects from recycling operations and wastes that are too demanding to recycle [14].

The energy recovery process also provides the opportunities of recovering secondary raw materials from waste such as metals eventually replacing virgin metals produced from excavated metal ore. Metals (including iron, steel, aluminium and copper) are recovered from the bottom ashes. Metals contained in compound waste products that would otherwise be difficult to recycle may be recycled after the thermal treatment in the WtE facility. The remaining bottom ash is used as aggregate for road construction. Furthermore, clean water may be recovered as a result of flue gas condensation.

The disadvantage is that a polluted, corrosive flue gas is formed, requiring extensive treatment, and that the flue gas treatment generates residues usually classified as hazardous waste. The capital costs are relatively high due to the flue gas treatment system, other environmental requirements, the heterogeneous nature of the fuel and corrosive properties of the flue gas. The corrosive nature of the flue gas also limits the permissible steam data to approximately 40 - 70 bar and 400-440°C [10] and hence the net power efficiency to around 20-30%. Due to the corrosive flue gasses the hottest parts of new boilers are often coated with expensive corrosion resistant alloys (Inconel).

The main advantage of a WtE HOP compared to a WtE CHP plant is lower investment and maintenance costs.

The main disadvantage of a WtE HOP is the lack of electricity sale and thus lower energy sales revenue and higher dependence on the sale of energy at the local heat market.

Environment

The environmental impact includes emissions to air and water, bottom ash (slag), and residues from flue gas treatment, including fly ash. Bottom ash making up around 15% of the mass input of waste is sorted to recover metals for recycling and production of aggregates for road construction.

Flue gas treatment residues and fly ash (totalling around 2-4% of the mass input of waste) are treated, e.g. through neutralisation with similar acid residues, and stored in a geologically stable underground deposit designed for the purpose. If the flue gas is treated by wet methods, there may also be an output of chloride containing waste water, which is treated at the plant to a purity that fulfils the requirements for discharge to the municipal sewerage system or to the sea. The discharged chloride salt substitutes deposition of a large quantity of solid residue.

On the positive side the recovered energy replaces energy produced from other resources and the emissions from this production, and recovered metals replace metals production from virgin ore.

Excess condensate from flue gas condensation may be considered a secondary raw material recycled for replacing water for technical purposes such as covering losses of district-heating networks to which the energy system is attached. The flue gas condensation system is usually located downstream of the flue gas treatment system, making the condensate low in salts and pollutants when leaving the condenser. The condensate could be treated further by electro deionization (EDI) and reverse osmosis to reach the quality required for its subsequent use or discharge to sensitive water recipients.

The air emissions from energy recovery of waste must comply with the environmental permit setting limit values on a range of pollutants including dust, CO, total organic carbon (TOC), HCl, SO₂, HF, NO_x, heavy metals and dioxins/furans. The limit values are based on the EU Industrial Emissions Directive (IED, [15]) of 2010 and the EU reference note on best available techniques for waste incineration (BAT-reference note or BREF [1]) supplemented by assessment of local conditions. Energy recovery also involves the generation of climate-relevant emissions of which mainly CO₂ and N₂O may be contributors. Methane, CH₄, is not emitted in any significant amount. It is destroyed in the combustion process and its potential emission included under the restrictive limit value of TOC.

Waste is a mixture of CO₂ neutral biomass and products of fossil origin, which are mostly plastics. The CO₂-emission from energy recovery of plastics is defined as fossil CO₂ emitted from the WtE-facility. Typically, 32% ±5% of the emitted CO₂ originates from fossil sources [3].

A typical emission factor for fossil CO₂ is 37.0 kg/GJ (LHV-basis) for the waste mixture currently incinerated in Denmark.

The IED includes a residence time requirement of the hot flue gas, meaning that the flue gas must be heated to min. 850°C for at least 2 seconds after the last air injection. This is to ensure conditions for complete burnout of the combustible gases and hence, ensure low emissions of CO, TOC and dioxins. HCl, HF and SO₂ are captured in the course of flue gas treatment and leave the facility in the solid flue gas treatment residue in the case of a dry or semi-dry FGT process. In case HCl, HF and SO₂ are removed by wet processes, the chloride in HCl will instead leave the facility in a chloride containing wastewater stream, which is treated to fulfil the local water emission limit values in addition to the IED limit values.

In general, political and economic framework conditions define the emission limits from WtE. A revised BAT reference note has been published in draft in 2017. The implications in terms of revised environmental requirements in the final version are uncertain.

Decision on pollutant abatement technology and hence, emission levels, are also affected by taxation. Currently (2018) emission tax is imposed on NO_x and SO₂.

Technical development in deNO_x-technology and gradually more stringent emission requirements are expected to lower emissions of NO_x for new facilities.

The solid residues from treatment of flue gas and wastewater are classified as hazardous wastes and they are usually treated before they are placed in an underground storage for hazardous waste (cf. Council Decision 2003/33) [17].

Research and development perspectives

The electrical efficiency of WtE CHPs may be increased with higher steam temperature and pressure. However, this may reduce the lifetime of the super-heater, due to corrosion by chloride and other aggressive ingredients in the flue gas, thereby increasing super-heater replacement rates and/or decreasing the operational availability. Simple solutions, which are common in the US, are to replace the super-heater regularly, and to protect the super-heater with a layer of Inconel, a corrosion resistant alloy. Another solution is to use a clean fuel (e.g. natural gas or self-produced gas) for heating an external super-heater, as implemented at Maabjerg Kraftvarmeværk, Holstebro. A novel proposed solution ("Steamboost" being developed by company Babcock & Wilcox Vølund) is to separate a less corrosive part of the flue gas from the last part of the furnace. An additional high temperature superheater installed in this flue gas can increase the steam temperature from the usual 400-440 °C to 480 °C. Operating at a higher temperature the new superheater will increase the electricity efficiency by 3-6 percentage points [12].

Technology with net power efficiency 25% is available now (up to 30% for power-only) but the future development is depending on the price on electrical power, which is currently low in Denmark. New plants are optimised for best net present value over the planning period which currently makes it unattractive to strive for very high power efficiency considering the increased capital cost and risk of corrosion. Optimisation may even question the concept of CHP compared to heat only boilers, depending on forecast of electricity prices and heat market availability and pricing. In Denmark, Scandinavia and other countries having district heating systems we expect the total energy efficiency to increase in the future due to increased penetration of flue gas

condensation possibly augmented by combustion air humidification, and decreasing return temperatures from the district heating (please, refer to Examples of best available technology).

Other energy conversion technologies may find its place such as organic rankine cycle (ORC), the use of which may significantly reduce the capital cost of a plant at the expense of some percent points of power generation efficiency.

Combustion air humidification is a method to increase the energy recovery by flue gas condensation without using a heat pump, as described in the Introduction to Waste and biomass. This technology is in successful use in several biomass plants in particularly Sweden and Finland. Combustion air humidification is expected to be introduced at the first WtE plant in Denmark within a few years.

Similarly, the amount of hazardous waste (fly ash and flue gas cleaning residue) may be reduced by optimisation of the overall process. In addition, treatment of residues may be further developed for recovery of salts and metals Zinc, in particular. Treatment may also render the residue non-hazardous easing the landfilling and possibly over time and development allowing use for construction purposes.

Advances in the metal recovery from the bottom ashes may increase the recycling rate. Dry bottom ash extraction systems are demonstrated at plants in Switzerland and allow increased metal recovery rates as sub-millimetre metal particles can be extracted and mechanically sorted in a non-corroded form. Even for wet extracted bottom ash metals recovery is expected to increase significantly through further development of sorting systems.

Prediction of performance and cost

When it comes to technological maturity, WtE is under Category 4, *Commercial technologies, with large deployment*. The technology has been used for 50 years, and more than 400 WtE plants are currently in operation in Europe most of which produce electricity and many of which are CHP-facilities, mainly in the Northern Europe [16].

Examples of market standard technology

Amager Bakke at ARC put in operation in 2017 has a waste capacity of 2 x 35 tonnes/hour, steam data 440°C and 70 bars. It is equipped with flue gas condensation augmented by large heat pumps that cool the flue gas to 22°C. The net power efficiency and total energy efficiency based on a lower heating value of 11.5 MJ/kg depends on the selected operation [11]:

CHP-operation without heat pumps: η_{el} : 25%, η_{total} : 95%

CHP-operation with heat pumps: η_{el} : 22%, η_{total} : 107%

Amager Bakke is expected to be one of the WtE plants with the highest total energy efficiency in the world. Only Fjernvarme Fyn in Odense will achieve a similar total efficiency when heat pump assisted flue gas condensation cooling the flue gas to 24°C is implemented here during 2017.

The Afval Energie Bedrijf in Amsterdam is the largest incineration plant in the world (1.5 million tonnes per year). The most recent extension (2007) involved 2 units of 34 tonnes/hour, steam data 440°C and 130 bar and river cooled condensers, which together with steam re-heating results in a net electricity efficiency of 30% when producing power-only [2]. This is the current world record power efficiency for WtE plants.

Uncertainty

The amount and the heating value of the available waste are dynamic properties, which change with time. Waste sorting (at source and central) and liberalization of commercial waste in DK are factors that might reduce the amount of residual waste and change its properties. In Sweden, relatively high recycling rates have not significantly changed the heating value of waste used in WtE.

Other more exotic processes such as thermal gasification may in a distant future develop and take over specific fractions from WtE.

Additional remarks

Contrary to other fuels used for energy generation, waste has a negative price and is received at a gate fee. The primary objective of a waste-to-energy plant is the treatment of waste. Produced energy may be considered a useful by-product although with increasing importance for the future Danish energy system with extensive use of district-heating and high power production from wind. The total energy production from a WtE boiler can be varied by varying the fuel feed, although WtE facilities run at full load most of the time if the district-heating demand allows together with additional cooling opportunities. Operation of WtE CHP-unit as power-only may not be financially attractive, and often CHP facilities are constructed so that operation at power-only is not physically possible, as the necessary cooling facilities are not in place. The heat production can be changed also by starting or stopping the flue gas condensation. The electricity production is usually fully flexible from CHP plants because the turbine can be by-passed fully or partly at short notice and the rate of change may be as high as the turbine allows. The heat generation is thus changed corresponding to the change in electricity generation.

A World Bank study projects a 70% global increase in urban solid waste – with developing countries facing the greatest challenges. The projected rise in the amount of waste, from 1.3 billion tonnes per year today to 2.2 billion tonnes per year by 2025, is expected to raise the annual global costs from \$205 billion to \$375 billion [5].

Even in Europe, the potential for WtE is huge. Only 6 countries have reduced the amount of municipal waste landfilled to a minimum: Austria, Belgium, Denmark, Germany, the Netherlands and Sweden landfill only 4% of municipal waste or less. They have all introduced landfill bans of combustible waste and worked towards a complementary waste management system where both recycling and waste-to-energy play a role in diverting waste from landfills (diagram below).

In a Danish perspective this may provide an opportunity of offering waste treatment at high resource efficiency by WtE-facilities from which virtually all energy is used. At the same time waste would replace the import of other fuels in the energy system. And with payment following the waste import, the treatment and energy recovery effectively becomes an export activity with a potentially advantageous business case.

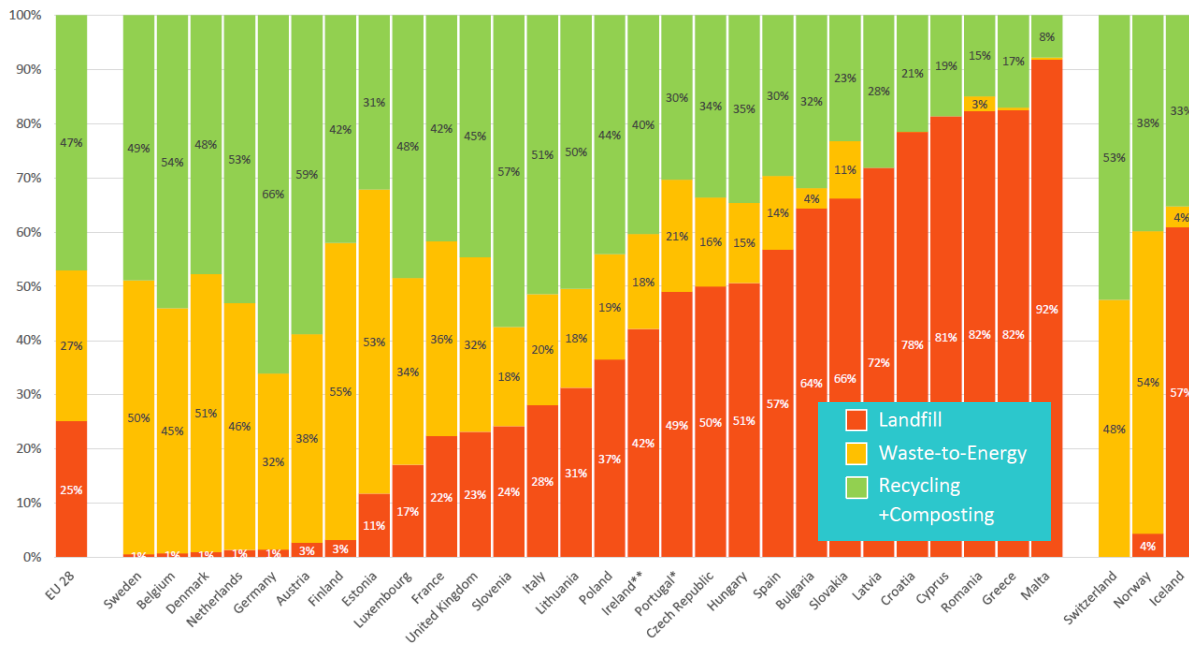

Figure 1 Waste management in Europe in 2016, Graph by CEWEP [4]. Source: EUROSTAT.

More information on development perspectives and future demand are published by various stake holders, plant manufacturers and World Bank, for example:

- www.cewep.eu
- www.eswet.eu
- www.worldbank.org
- www.iswa.org

References

- [1] Reference Document on the Best Available Techniques for Waste Incineration' (BREF), European Commission, August 2006, and draft revised edition of May 2017, available from <http://eippcb.jrc.ec.europa.eu/reference/> (last visited 01.08.2018).
- [2] <http://www.aebamsterdam.com/>
- [3] PSO-0213: Biogenic Carbon in Danish Combustible Waste
- [4] <http://www.cewep.eu/wp-content/uploads/2017/07/Graph-3-treatments-2016.pdf>
- [5] <http://www.worldbank.org/en/news/feature/2012/06/06/report-shows-alarming-rise-in-amount-costs-of-garbage> (last visited 01.08.2018).
- [6] ARC, Kirstine Hansen, Email 2015-05-07.
- [7] Vestforbrænding I/S, Grønt regnskab (Green accounts) of 2013 and 2015, respectively. Available at <http://www.vestfor.dk/Om-Vestforbraending/Nogleta> (last visited 01.08.2018).
- [8] Vestforbrænding I/S, Arne Nielsen, Email 2015-05-11.
- [10] Newsletter, Babcock Wilcox & Vølund, December 2012
http://www.volund.dk/News/2014/01/Newsletter/Amager_Bakke (last visited 01.08.2018).
- [11] Inger Anette Søndergaard, Tore Hulgaard and Lasse Tobiasen; High Efficient Waste-to-Energy Facilities, in Karl. J. Thomé-Kozmiensky and Stephanie Thiel, Waste Management, vol 4 Waste-to-Energy, TK Verlag 2014.
- [12] Newsletter, Babcock Wilcox & Vølund, December 2016
<http://www.volund.dk/News/2016/12/08/SteamBoost> (last visited 01.08.2018).
- [13] Calculations by Rambøll. Not published.
- [14] Hulgaard, Tore; Circular economy: Energy and fuels, International Solid Waste Association, ISWA 2015, available from <http://www.iswa.org/iswa/iswa-groups/task-forces/> (last visited 01.08.2018).
- [15] Industrial Emissions Directive (IED), Directive 2010/75/EU of the European Parliament and of the Council of 24 November 2010 on industrial emissions (integrated pollution prevention and control).
<http://ec.europa.eu/environment/industry/stationary/ied/legislation.htm> (last visited 01.08.2018).
- [16] ISWA, Waste-to-Energy, State-of-the-Art-Report, 6th edition, August 2012.
- [17] COUNCIL DECISION of 19 December 2002 establishing criteria and procedures for the acceptance of waste at landfills pursuant to Article 16 of and Annex II to Directive 1999/31/EC (2003/33/EC).

Data sheets WtE CHP, small

Notes and references are common for all the datasheets and can be found below the last data sheet.

Technology	Small Waste to Energy CHP, Back pressure turbine, 35 MW feed									
	2015	2020	2030	2050	Uncertainty (2020)		Uncertainty (2050)		Note	Ref
Energy/technical data					Lower	Upper	Lower	Upper		
Generating capacity for one unit (MWe)	7.9	7.9	8.2	8.3	7.3	8.5	7.3	9.1	A, B	
Incineration capacity (Fuel input) (tonnes/h)	11.9	11.9	11.9	11.9	11.9	11.9	11.9	11.9	A, B	
Electricity efficiency, net (%), name plate	22.6	22.6	23.5	23.7	20.9	24.3	20.9	25.9	A, B, C	
Electricity efficiency, net (%), annual average	21.4	21.4	22.3	22.5	18.8	23.1	18.8	24.6	A, B, C	
Heat efficiency, net (%), name plate	78.5	78.5	77.8	78.6	75.5	82.8	72.3	84.5	A, B	
Heat efficiency, net (%), annual average	79.6	79.6	79.0	79.8	77.6	84.1	74.4	85.8	A, B, C	
Additional heat potential with heat pumps (% of thermal input)	4.1	4.1	4.0	3.8	2.0	5.1	1.9	5.1	A, B, D	
Cb coefficient (40°C/80°C)	0.29	0.29	0.30	0.30	0.27	0.31	0.27	0.33	A, B	
Cv coefficient (40°C/80°C)	1	1	1	1	1	1	1	1	A, B	
Forced outage (%)	1	1	1	1	1	1	1	1		1
Planned outage (weeks per year)	3.5	3.3	3.0	2.5	2.8	3.8	1.8	3.1	E	1
Technical lifetime (years)	25	25	25	25	20	35	20	35		1
Construction time (years)	2.5	2.5	2.5	2.5	2	3	1.5	3		1
Space requirement (1000 m ² /MWe)	2.5	2.5	2.4	2.4	2.2	2.9	1.8	3.0		1
Primary regulation (% per 30 seconds)	NA	NA	NA	NA	NA	NA	NA	NA	F	
Secondary regulation (% per minute)	10	10	10	10	10	10	10	10	F, G	
Minimum load (% of full load)	20	20	20	20	20	20	20	20	F, G	
Warm start-up time (hours)	0.5	0.5	0.5	0.5	0.5	0.5	0.5	0.5	F, G	
Cold start-up time (hours)	2	2	2	2	2	2	2	2	F, G	
Environment										
SO ₂ (degree of desulphuring, %)	99.8	99.8	99.8	99.8	99.0	99.9	99.5	99.9	H	1
NO _X (g per GJ fuel)	90	67	56	22	11	84	5	56	I	2;3
CH ₄ (g per GJ fuel)	0.3	0.1	0.1	0.1	0	0.1	0	0.1		2
N ₂ O (g per GJ fuel)	1.2	1	1	1	1	3	0	1	J	2
Particles (g per GJ fuel)	0.3	0.3	0.3	0.3	0.1	2	0.1	1	J	2
Financial data										
Nominal investment	10.7	10.5	9.6	8.8	8.9	12.3	6.4	11.0	N	1

(M€/MWe)										
- of which equipment	6.7	6.5	6.0	5.6	5.5	7.7	4.0	6.9	N	1
- of which installation	4.1	4.0	3.6	3.2	3.4	4.5	2.4	4.1	M	1
Fixed O&M (€/MWe/year)	427,800	413,600	372,400	329,500	380,500	446,700	276,500	375,600	L	1
Variable O&M (€/MWh _e)	25.6	25.6	24.6	24.4	21.7	29.4	18.3	30.5	K	1
Technology specific data										
Steam reheat	None	None	None	None	None	None	None	None		
Flue gas condensation	Yes	Yes	Yes	Yes	Yes	Yes	Yes	Yes		
Combustion air humidification	No	No	No	No	No	Yes	No	Yes		
Nominal investment (M€/MW fuel input)	2.42	2.36	2.25	2.09	2.01	2.77	1.52	2.60	N	1
- of which equipment	1.92	1.47	1.40	1.32	1.25	1.75	0.95	1.64	N	1
- of which installation	1.17	0.89	0.85	0.77	0.76	1.03	0.58	0.96	M	1
Fixed O&M (€/MW input/year)	96,500	93,400	87,400	78,100	79,400	108,500	57,700	97,300	L	1
Variable O&M (€/MWh input)	5.8	5.8	5.8	5.8	4.9	6.6	4.3	7.2	K	1
Nominal investment (€/tonne/year)	891	869	827	770	739	1,021	561	957	N	1
Fixed O&M (€/tonne)	36	34	32	29	29	40	21	36	L	1;4
Variable O&M (€/tonne)	17	17	17	17	14	20	13	21	K	1;4

Data sheets WtE CHP, medium

Technology	Medium Waste to Energy CHP, Back pressure turbine, 80 MW feed									
	2015	2020	2030	2050	Uncertainty (2020)		Uncertainty (2050)		Note	Ref
Energy/technical data					Lower	Upper	Lower	Upper		
Generating capacity for one unit (MWe)	18.4	18.4	18.9	19.5	17.0	20.0	17.0	21.4	A, B	
Incineration capacity (Fuel input) (tonnes/h)	27.2	27.2	27.2	27.2	27.2	27.2	27.2	27.2	A, B	
Electricity efficiency, net (%), name plate	23.0	23.0	23.6	24.4	21	25	21	27	A, B, C	
Electricity efficiency, net (%), annual average	21.9	21.9	22.4	23.2	19	24	19	25	A, B, C	
Heat efficiency, net (%), name plate	78.0	78.0	77.7	77.3	75	83	71	85	A, B	
Heat efficiency, net (%), annual average	79.1	79.1	78.9	78.6	77	84	73	86	A, B, C	
Additional heat potential with heat pumps (% of thermal input)	4.1	4.1	4.0	3.7	2	5	2	5	A, B, D	
Cb coefficient (40°C/80°C)	0.30	0.30	0.30	0.32	0.27	0.32	0.27	0.35	A, B	
Cv coefficient (40°C/80°C)	1	1	1	1	1	1	1	1	A, B	
Forced outage (%)	1	1	1	1	1	1	1	1		1
Planned outage (weeks per year)	3.0	2.9	2.6	2.1	2.4	3.3	1.6	2.6	E	1
Technical lifetime (years)	25	25	25	25	20	35	20	35		1
Construction time (years)	2.5	2.5	2.5	2.5	2.0	3.0	1.5	3.0		1
Space requirement (1000 m ² /MWe)	1.6	1.6	1.6	1.5	1.4	1.9	1.2	1.9		1
Environment										
Primary regulation (% per 30 seconds)	5	5	5	5	5	5	5	5	F	
Secondary regulation (% per minute)	10	10	10	10	10	10	10	10.0	F, G	
Minimum load (% of full load)	20	20	20	20	20	20	20	20.0	F, G	
Warm start-up time (hours)	0.5	0.5	0.5	0.5	0.5	0.5	0.5	0.5	F, G	
Cold start-up time (hours)	2	2	2	2	2	2	2	2	F, G	
Financial data										
Nominal investment (M€/MWe)	9.3	9.1	8.7	7.6	7.7	10.7	5.5	9.5	N	1
- of which equipment	5.7	5.5	5.4	4.7	4.7	6.6	3.4	5.8	N	1
- of which installation	3.7	3.6	3.3	2.9	3	4.1	2.2	3.6	M	1

Fixed O&M (€/MWe/year)	300,700	264,800	246,700	210,600	244,200	284,600	178,000	239,500	L	1
Variable O&M (€/MWh_e)	25	25	24.5	23.7	21.3	28.8	17.7	29.6	K	1
Technology specific data										
Steam reheat	None	None	None	None	None	None	None	None		
Flue gas condensation	Yes	Yes	Yes	Yes	Yes	Yes	Yes	Yes		
Combustion air humidification	No	No	No	No	No	Yes	No	Yes		
Nominal investment (M€/MW fuel input)	2.15	2.10	2.05	1.86	1.78	2.46	1.35	2.31	N	1
- of which equipment	1.31	1.28	1.26	1.15	1.08	1.52	0.82	1.42	N	1
- of which installation	0.84	0.82	0.78	0.71	0.70	0.95	0.53	0.88	M	1
Fixed O&M (€/MW input/year)	69,300	61,000	58,200	51,400	51,900	71,200	37,800	64,000	L	1
Variable O&M (€/MWh input)	5.8	5.8	5.8	5.8	4.9	6.6	4.3	7.2	K	1
Nominal investment (€/tonne/year)	792	773	753	683	657	907	499	849	N	1
Fixed O&M (€/tonne)	26	22	21	19	19	26	14	24	L	1;4
Variable O&M (€/tonne)	17	17	17	17	14	20	13	21	K	1;4

Data sheets WtE CHP, large

Technology	Large Waste to Energy CHP, Back pressure turbine, 220 MW feed									
	2015	2020	2030	2050	Uncertainty (2020)		Uncertainty (2050)		Note	Ref
					Lower	Upper	Lower	Upper		
Energy/technical data										
Generating capacity for one unit (MWe)	51.2	51.2	52.5	54.4	47.2	55.7	47.2	59.8	A, B	
Incineration capacity (Fuel input) (tonnes/h)	74.7	74.7	74.7	74.7	74.7	74.7	74.7	74.7	A, B	
Electricity efficiency, net (%), name plate	23.3	23.3	23.9	24.7	21	25	21	27	A, B	
Electricity efficiency, net (%), annual average	22.1	22.1	22.7	23.5	19	24	19	26	A, B, C	
Heat efficiency, net (%), name plate	78.1	78.1	77.8	77.4	75	83	71	85	A, B	
Heat efficiency, net (%), annual average	79.3	79.3	79.0	78.7	77	84	73	86	A, B, C	
Additional heat potential with heat pumps (% of thermal input)	4.1	4.1	4.0	3.7	2	5	2	5	A, B, D	
Cb coefficient (40°C/80°C)	0.30	0.30	0.31	0.32	0.27	0.32	0.28	0.35	A, B	
Cv coefficient (40°C/80°C)	1	1	1	1	1	1	1	1	A, B	
Forced outage (%)	1	1	1	1	1	1	1	1		1
Planned outage (weeks per year)	2.5	2.4	2.2	1.8	2.0	2.7	1.3	2.2	E	1
Technical lifetime (years)	25	25	25	25	20	35	20	35		1
Construction time (years)	3.0	3.0	3.0	3.0	2.5	3.5	2.0	3.5		1
Space requirement (1000 m ² /MWe)	0.8	0.8	0.8	0.7	0.7	0.9	0.6	0.9		1
Environment										
Primary regulation (% per 30 seconds)	5	5	5	5	5	5	5	5	F	
Secondary regulation (% per minute)	10.0	10.0	10.0	10.0	10.0	10.0	10.0	10.0	F, G	
Minimum load (% of full load)	20.0	20.0	20.0	20.0	20.0	20.0	20.0	20.0	F, G	
Warm start-up time (hours)	0.5	0.5	0.5	0.5	0.5	0.5	0.5	0.5	F, G	
Cold start-up time (hours)	2	2	2	2	2	2	2	2	F, G	
Financial data										
Nominal investment (M€/MWe)	8.0	7.8	7.4	6.5	6.7	9.2	4.8	8.1	N	1
- of which equipment	4.8	4.7	4.6	4.0	4.0	5.6	2.9	5.0	N	1

- of which installation	3.2	3.1	2.9	2.5	2.6	3.6	1.9	3.2	M	1
Fixed O&M (€/MWe/year)	231,700	188,300	175,600	149,600	173,900	202,400	126,500	169,300	L	1
Variable O&M (€/MWh _e)	24.8	24.8	24.2	23.3	21.1	28.5	17.5	29.2	K	1
Technology specific data										
Steam reheat	None	None	None	None	None	None	None	None		
Flue gas condensation	Yes	Yes	Yes	Yes	Yes	Yes	Yes	Yes		
Combustion air humidification	No	No	No	No	No	Yes	No	Yes		
Nominal investment (M€/MW fuel input)	1.87	1.83	1.78	1.61	1.55	2.14	1.18	2.00	N	1
- of which equipment	1.13	1.10	1.09	0.99	0.94	1.31	0.71	1.22	N	1
- of which installation	0.74	0.72	0.69	0.62	0.62	0.83	0.47	0.78	M	1
Fixed O&M (€/MW input/year)	54,000	43,900	41,900	37,000	37,300	51,300	27,100	46,000	L	1
Variable O&M (€/MWh input)	5.8	5.8	5.8	5.8	4.9	6.6	4.3	7.2	K	1
Nominal investment (€/tonne/year)	689	672	654	593	571	788	434	738	N	1
Fixed O&M (€/tonne)	20	16	15	14	14	19	10	17	L	1;4
Variable O&M (€/tonne)	17	17	17	17	14	20	13	21	K	1;4

Notes:

Notes common for all the waste CHP data sheets

- A Assumed lower heating value 10.6 MJ/kg, waste input 74.7 tph = tonnes per hour (incineration capacity) divided in two, equally sized furnace/boiler units , corresponding to thermal input of 2x110 MW. One common turbine/generator set is foreseen. Live steam pressure in base case 50 bara, temperature 425 °C of 2015 and 2020, increasing to 440 °C and 450 °C, in 2030 and 2050, respectively. Efficiencies refer to lower heating value.
- B With flue gas condensation (condensation through heat exchange with DH-water, only) and a back-pressure turbine/condenser system optimised for DH return temperature 40°C and flow 80°C.
- C Annual average heat output is higher than nameplate because the total efficiency is constant, and the annual average electricity generation is lower than nameplate electricity output. The parasitic electricity consumption has been subtracted in the listed electricity efficiencies.
- D Additional heat potential for heat pump is the flue gas condensation potential remaining after the direct condensation stage (condensation by heat exchange with DH-water).
- E Focus on availability and ambitions of 2 years' continuous operation is expected to gradually reduce planned outage.
- F Regulation and start-up refer to electricity generation controlled by the turbine operation. The WtE facility would usually be operating at 100% thermal input, and the electricity output is controlled to the desired level by use of turbine bypass, by which excess steam is used to produce DH-energy. Warm start-up time refers to 2 days down-time of the turbine.
- G The combustion process and boiler may be regulated approx. 1% per minute considering extensive use of inconell (in stead of refractory, which may limit rate of change to 0.5% per minute). Minimum load is typically 70% of thermal input under which limit it may be difficult to comply with the requirement of min. 2 sec residence time of the flue gas at min. 850 °C after the last air injection. Below this limit it may also be a challenge to ensure sufficient superheating of the steam. Warm start-up of the combustion process is typically 8 hours and cold start-up is 8 hours.
- H Assumed low SO₂-emission 1 g/GJ in 2015 considering the use of flue gas condensation by wet scrubbing downstream the flue gas treatment system. Sulphur content in fuel 270 g/GJ.
- I Increased focus on NO_x reduction is expected in the future, requiring use of SNCR technology to its utmost potential by 2030 (at 60 g/GJ) and use of the more effective catalytic SCR-technology by 2050. The SCR-technology entails additional investment.
- J N₂O is expected to be related primarily to the use of SNCR. This is why little N₂O is expected when the SCR-deNO_x

technology is used (indicated by verly low NO_x-level).

- K Variable O&M cost includes consumables (for FGT etc.), disposal of residues, small share of staff-cost and maintenance cost. Electricity consumption is not included, and revenues from sale of electricity and heat are not included. Taxes are not included.
- L Fixed O&M include amongst other things the major part of staffing and maintenance, analyses, research and development, accounting, insurances, fees, memberships, office. Not included are finance cost, depreciation and amortisation.
- M Installation includes civils works (including waste bunker) and project cost considering LOT-based tendering.
- N Assuming LOT-based tendering of electromechanic equipment.

References

References common for all the waste CHP data sheet

- 1 Rambøll present work, range of WtE-projects
- 2 Emission factors of 2006: 102 g/GJ NO_x, <8,3 g/GJ for SO₂, <0,34 g/GJ for CH₄, 1,2 g/GJ for N₂O, cf. Nielsen, M., Nielsen, O.-K. & Thomsen, M. 2010: Emissions from decentralised CHP plants 2007 - Energinet.dk Environmental project no. 07/1882. Project report 5 – Emission factors and emission inventory for decentralised CHP production. National Environmental Research Institute, Aarhus University. 113 pp. – NERI Technical report No. 786.
<http://www.dmu.dk/Pub/FR786.pdf>.
- 3 Environmental permit of recently constructed WtE-facility includes NO_x limit value of 180 mg/Nm³ =100 g/GJ. Operation is expected well below limit value. Cf. Miljøstyrelsen, "Tillæg til miljøgodkendelse, Ny ovnlinje 5 på Nordforbrænding, Juni 2013,"
<http://mst.dk/media/mst/Attachments/Tillgtilmiljogodkendelseovn5Juni2013.pdf>
- 4 To scenarier for tilpasning af affaldsforbrændingskapaciteten i Danmark. EA Energianalyse 2014.

Data sheets: Waste, HOP

Technology	Waste to Energy, DH only, 35 MW feed									
	2015	2020	2030	2050	Uncertainty (2020)		Uncertainty (2050)		Note	Ref
Energy/technical data					Lower	Upper	Lower	Upper		
Heat generation capacity for one unit (MW)	36.6	36.6	36.7	36.9	36.3	37.5	36.3	37.7	A, B	
Incineration capacity (Fuel input) (tonnes/h)	11.9	11.9	11.9	11.9	11.9	11.9	11.9	11.9	A, B	
Total heat efficiency, net (%), ref. LHV, name plate	104.7	104.7	105.0	105.5	104	107	104	108	A, B, C	
Total heat efficiency, net (%), ref. LHV, annual average	104.7	104.7	105.0	105.5	104	107	104	108	A, B, C	
Additional heat potential with heat pumps (% of thermal input)	4.1	4.1	4.0	3.7	2	5	2	5	A, B, D	
Auxiliary electricity consumption (% of heat gen)	2.6	2.6	2.6	2.5	2.0	2.7	1.6	2.6	A, B, C	
Forced outage (%)	1	1	1	1	1	1	1	1		1
Planned outage (weeks per year)	3.0	2.9	2.6	2.1	2.4	3.3	1.6	2.6	E	1
Technical lifetime (years)	25	25	25	25	20	35	20	35		1
Construction time (years)	2	2	2	2	1.5	2.5	1.5	2.5		1
Space requirement (1000 m ² /MWth heat output)	0.55	0.55	0.54	0.54	0.46	0.63	0.41	0.68		1
Regulation										
Primary regulation (% per 30 seconds)	NA	NA	NA	NA	NA	NA	NA	NA	F	
Secondary regulation (% per minute)	1	1	1	1	1	1	1	1	F, G	
Minimum load (% of full load)	70	70	70	70	70	70	70	70	F, G	
Warm start-up time (hours)	8	8	8	8	8	8	8	8	F, G	
Cold start-up time (hours)	12	12	12	12	12	12	12	12	F, G	
Environment										
SO ₂ (degree of desulphuring, %)	99.8	99.8	99.8	99.8	99.0	99.9	99.5	99.9	H	1
NO _x (g per GJ fuel)	90	67	56	22	11	84	5	56	I	2;3
CH ₄ (g per GJ fuel)	0.3	0.1	0.1	0.1	0	0.1	0	0.1		2
N ₂ O (g per GJ fuel)	1.2	1	1	1	1	3	0	1	J	2
Particles (g per GJ fuel)	0.3	0.3	0.3	0.3	0.1	2	0.1	1	J	2
Financial data										
Nominal investment (M€/MWth - heat output)	1.80	1.75	1.66	1.55	1.53	2.12	1.24	2.13	P	
- of which equipment	1.03	1.01	0.96	0.92	0.88	1.24	0.71	1.24	P	
- of which installation	0.77	0.75	0.71	0.64	0.65	0.88	0.53	0.88	P	
Fixed O&M (€/MWth/year), heat output	81,300	78,600	73,300	65,300	68,000	90,100	50,700	82,500	P	
Variable O&M (€/MWh) heat output	5.5	5.5	5.5	5.5	4.7	6.3	4.1	6.8	P	
Technology specific data										
Flue gas condensation	Yes	Yes	Yes	Yes	Yes	Yes	Yes	Yes	N	
Combustion air humidification	No	No	No	No	No	Yes	No	Yes	N	
Nominal investment (M€/MW fuel input)	1.88	1.84	1.75	1.64	1.60	2.22	1.31	2.24	N	1

- of which equipment	1.08	1.05	1.00	0.97	0.92	1.30	0.75	1.31	N	1
- of which installation	0.80	0.78	0.74	0.67	0.68	0.92	0.56	0.93	M	1
Fixed O&M (€/MW input/year)	85,200	82,300	77,000	68,800	70,500	96,600	52,600	88,800	L	1
Variable O&M (€/MWh input)	7.4	7.6	8.4	8.7	6.2	8.5	6.1	10.3		
- of which is electricity costs (€/MWh)	1.6	1.8	2.6	2.9	1.3	1.9	1.8	3.1	C	
- of which is other O&M costs (€/MWh)	5.8	5.8	5.8	5.8	4.9	6.6	4.3	7.2	K	1
Nominal investment (€/(tonne/year))	693	676	643	604	589	819	482	826	N	1
Fixed O&M (€/tonne)	31	30	28	25	26	36	19	33	L	1;4
Variable O&M (€/tonne)	17	17	17	17	14	20	13	21	K	1;4

Notes:

- A Assumed lower heating value 10.6 MJ/kg, waste input 11.9 tph = tonnes per hour (incineration capacity), corresponding to thermal input of 35 MW. Efficiencies refer to lower heating value.
- B With flue gas condensation (condensation through heat exchange with DH-water, only), DH return temperature 40°C and flow 80°C
- C The stated total efficiency does NOT consider auxiliary electricity consumption. It describes the total net amount of heat produced at the plant. This is contrary to CHP where the auxiliary electricity is subtracted from the production to yield the net electricity efficiency. Instead the cost of auxiliary electricity consumption is included in variable O&M and is calculated using the following electricity prices in €/MWh: 2015: 63, 2020: 69, 2030: 101, 2050: 117. These prices include production costs and transport tariffs, but not any taxes or subsidies for renewable energy.
- D Additional heat potential for heat pump is the flue gas condensation potential remaining after the direct condensation stage (condensation by heat exchange with DH-water)
- E Focus on availability and ambitions of 2 years' continuous operation is expected to gradually reduce planned outage.
- F Regulation and start-up refer to electricity generation controlled by the turbine operation. The WtE facility would usually be operating at 100% thermal input, and the electricity output is controlled to the desired level by use of turbine by-pass, by which excess steam is used to produce DH-energy. Warm start-up time refers to 2 days down-time of the turbine.
- G The combustion process and boiler may be regulated approx. 1% per minute considering extensive use of inconell (in stead of refractory, which may limit rate of change to 0.5% per minute). Minimum load is typically 70% of thermal input under which limit it may be difficult to comply with the requirement of min. 2 sec residence time of the flue gas at min. 850 °C after the last air injection. Below this limit it may also be a challenge to ensure sufficient superheating of the steam. Warm start-up of the combustion process is typically 8 hours and cold start-up is 8 hours.
- H Assumed low SO₂-emission 1 g/GJ in 2015 considering the use of flue gas condensation by wet scrubbing down-stream the flue gas treatment system. Sulphur content in fuel 270 g/GJ
- I Increased focus on NO_x reduction is expected in the future, requiring use of SNCR technology to its utmost potential by 2030 (at 60 g/GJ) and use of the more effective catalytic SCR-technology by 2050. The SCR-technology entails additional investment.
- J N₂O is expected to be related primarily to the use of SNCR. This is why little N₂O is expected when the SCR-deNO_x technology is used (indicated by verly low NO_x-level).
- K Variable O&M cost includes consumables (for FGT etc.), disposal of residues, small share of staff-cost and maintenance cost. Electricity consumption is not included, and revenues from sale of electricity and heat are not included. Taxes are not included.
- L Fixed O&M include amongst other things the major part of staffing and maintenance, analyses, research and development, accounting, insurances, fees, memberships, office. Not included are finance cost, depreciation and amortisation.
- M Installation includes civils works (including waste bunker) and project cost considering LOT-based tendering
- N Assuming LOT-based tendering of electromechanic equipment
- P Reference to heat output because of the lack of electricity production

References

- 1 Rambøll present work, range of WtE-projects

- 2 Emission factors of 2006: 102 g/GJ NO_x, <8,3 g/GJ for SO₂, <0,34 g/GJ for CH₄, 1,2 g/GJ for N₂O, cf. Nielsen, M., Nielsen, O.-K. & Thomsen, M. 2010: Emissions from decentralised CHP plants 2007 - Energinet.dk Environmental project no. 07/1882. Project report 5 – Emission factors and emission inventory for decentralised CHP production. National Environmental Research Institute, Aarhus University. 113 pp. – NERI Technical report No. 786.
<http://www.dmu.dk/Pub/FR786.pdf>.
- 3 Environmental permit of recently constructed WtE-facility includes NO_x limit value of 180 mg/Nm³ =100 g/GJ. Operation is expected well below limit value. Cf. Miljøstyrelsen, "Tillæg til miljøgodkendelse, Ny ovnlinje 5 på Nordforbrænding, Juni 2013,"
<http://mst.dk/media/mst/Attachments/Tillgtilmiljogodkendelseovn5Juni2013.pdf>
- 4 To scenarier for tilpasning af affaldsforbrændingskapaciteten i Danmark. EA Energianalyse 2014.

09 Biomass CHP and HOP plants

Contact information

Danish Energy Agency: Rikke Næraa/Filip Gamborg
Author: Rambøll: Tore Hulgaard, Claus Hindsgaul, Niels Houbak
Reviewer:

Publication date

March 2018

Amendments after publication date

Date	Ref.	Description
September 2018	09 Biomass CHP and HOP	Updated qualitative description and merging of CHP and HOP descriptions

Qualitative description

Brief technology description

Energy conversion in CHP or HOP of biomass is the combustion of wood-chips from forestry and/or from wood industry, wood pellets or straw. The main technical differences between the two are the electricity production, which is produced in a CHP but not a HOP, and the resulting necessary operating temperatures.

CHP production from biomass has been used in an increasing scale for many years in Denmark utilizing different technologies. The typical implementation is combustion in a biomass boiler feeding a steam turbine. The energy output from the boiler is either hot water to be used directly for district heating or it could be (high pressure) steam to be expanded through a turbine.

Application of flue gas condensation for further energy generation is customary at biomass fired boilers, except at small plants below 1 - 2 MW_{th input} due to the additional capital and O&M costs. Plants without flue gas condensation should only use fuels with less than 30% moisture content.

Flue gas condensation is available also for straw firing. The flue gas condensation may raise the efficiency with around 15%-points according to model calculations (at 40°C DH return temperature), representing advances in condensation efficiency and return temperature compared with previous indications of 5-10%. Currently in Denmark only a few straw-fired plants are equipped with flue gas condensation.

Straw-fired boilers are normally equipped with a bag filter for flue gas cleaning. Electro filters do not work as efficiently with straw firing as they do with wood firing due to deposits formed by salts in the straw.

Straw fired plants should be equipped with heat accumulation tanks due to their disability to produce at less than 40% of full load, as described under the section "Regulation ability".

ORC plant

An alternative type of plant is the organic rankine cycle plants (ORC plants). In this the (biomass-) boiler is used for heating (no evaporation) thermal oil to slightly above 300°C. This heated oil transfers the heat to an ORC plant which is similar to a steam cycle but it uses a refrigerant instead of water as working media.

The reason for an interest in ORC plants is that such equipment is delivered in standardized complete modules at an attractive price and in combination with 'a boiler' that only is used for heating oil, the investment is relatively modest.

The ORC technology is a waste heat recovery technology developed for low temperature and low-pressure power generation. The ORC unit is a factory assembled module – this makes them less flexible but cheap. This may make it financially attractive to build small scale CHP facilities. The 'Rankine' part indicates that it is a technology with similarities to water-steam (Rankine) based systems. The main difference being the use of a media i.e. a refrigerant or silicone oil (an organic compound that can burn but does not explode) with thermodynamic properties that makes it more adequate than water for low temperature power generation.

Common technology description for biomass and WtE is found in Introduction to Waste and Biomass plants. Also, flue gas condensation, combustion air humidification, fuels and an improved energy model for technology data is described there.

Input

The fuel input to biomass plants can in general be described as biomass; e.g. residues from wood industries, wood chips (from forestry), straw and energy crops. Combustion can in general be applied for biomass feedstock with average moisture contents up to 60% for wood chips and up to 25% for straw dependent on combustion technology. The three types of biomass feedstock considered here are: Wood chips, wood pellets (white pellets), and straw. They are in several ways very different (humidity, granularity, ash content and composition, grindability, and density).

Sometimes it is possible to change fuel at a plant from one type of biomass to another, but it should be explicitly guaranteed by the supplier of the plant. Below is a broad description of biomass fuels.

Wood (particularly in the form of chips) is usually the most favourable biomass for combustion due to its low content of ash, nitrogen and alkaline metals, however typically with 45 % moisture for chips and below 10% for pellets. Herbaceous biomass like straw, miscanthus and other annual/fast growing crops have higher contents of K, N, Cl, S etc. that lead to higher primary emissions of NO_x and particulates, increased ash generation, corrosion rates and slag deposits.

The amount of biomass available for energy production varies over time. From 2006 to 2014, the Danish straw production varied between 5.2 and 6.3 million tonnes per year (avg. 5.6 mil. t.), while the amount used for energy varied between 1.4 and 2 million tonnes (avg. 1.6 mil. t.).

Other exotic biomasses as empty fruit bunch pellets (EFB) and palm kernel shells (PKS) are available in the market; however, operating experience seems to be limited.

Forest residues are typically delivered as wood chips. Forest residues may also be delivered as pellets. During pellet production the fuel is dried to moisture content below 10%. As of today, the use of forest biomass for energy purposes accounts for only a small percentage of the total forest biomass production for, say, timber, paper, and other industrial purposes; thus typically biomass for energy purposes is (and must be) a residual product. This is also reflected by the fact that the current price per GJ for wood products for energy purposes is much lower than the price for industrial applications of wood. Further to this there seems to be a growing interest for utilizing other types of surplus biomass from industrial productions like Vinery, olive oil production, sugar production, and more.

Wood chips are wood pieces of 5-50 mm in the fibre direction, longer twigs (slivers), and a fine fraction (fines). The quality description is based on three types of wood chips: Fine, coarse, and extra coarse. The names refer to the size distribution only, not to the quality. Fine particles as well as thin, long fibres may cause problems (in case the boiler is using grate firing). In the table below can be seen some typical (commercial) requirements for wood chips.

Typical sizes in a sample:

Name	Withhold on sieve	Share w%
Fines	<3 mm	<12
Small	3 < X < 8 mm	<25
Coarse	8 < X < 16 mm	No requirm
Extra coarse	16 < X < 45 mm	No requirm
Over size	45 < X < 63 mm	< 3
Over long 10	> 63 mm	< 6
Over long 20	100-200 mm long	< 1.5

Table 1 General terms and commercial requirements for wood chips

Ash concentrations must not exceed 2% on dry basis.

Existing DH boilers in Denmark can burn wood-chips with up to 45-63% moisture content, depending on technology. In 2014-2015, the actual moisture content was 40% in average, varying between 25 and 55% [1]. Wood chips with high moisture content will often be mixed with dry wood chips.

Other possible fuels are chipped energy crops (e.g. willow and poplar) and chipped park and garden waste. The fuel quality must be in focus. Small particles must be avoided as well as long thin pieces. High moisture content of e.g. willow will increase the level of CO and PAH, so either the willow must be low in moisture content or it must be mixed with other fuels. Willow is known to take up Cadmium from the soil and thus increasing the concentrations in ash. The amount of cadmium up take is depending on where the willow is grown. Poplar has been found to give problems in the boiler like “popcorn” in a combustion test. Chipped Park and garden waste must be of a good quality with low content of non-combustible materials, because of risks of blocking the grate [1]. Difficult biomass residues are therefore often utilised in WtE facilities having available capacity.

Wood pellets are made from wood chips, sawdust, wood shavings and other residues from sawmills and other wood manufacturers. Pellets are produced in several types and grades as fuels for electric power plants and DH (low grade), and homes (high grade). Pellets are extremely dense (up to the double of the density of the basic material) and can be produced with a low humidity content (below 5% for high grade products) that allows easy handling (incl. long-term storage) and to be burned with high combustion efficiencies. When humidified, pellets are prone to auto-ignition. When exposed to mechanical treatment like conveyer transportation the pellets may break (or disintegrate) and release dust; this dust is highly explosive and therefore constitute a serious hazard. Danish plants using wood pellets or –chips must ensure the sustainability of the fuel. Both the disintegration of wood chips in hammer mills and the subsequent drying require energy and this must come from non-fossil sources (e.g. the wood itself).

Straw is a by-product from the growing of commercial crops, in North Europe primarily cereal grain, rape and other seed-producing crops. Straw is often delivered as big rectangular bales (Heston bales), typically approx. 5-700 kg each, from storages at the farms to the DH plants etc. during the year pursuant to concluded straw delivery contracts.

Output

The products from biomass CHP plants are electricity and heat as steam, hot ($> 110^{\circ}\text{C}$) or warm ($< 110^{\circ}\text{C}$) water.

The output from biomass HOP is hot water for district heat or low-pressure steam for industrial purposes. The total energy efficiency is identical for heat and CHP plants, except that some minor heat losses in the generator and turbine gearbox of the CHP plant are avoided. The heat production from a HOP is thus identical (or slightly higher) than the sum of produced electricity and heat from an equivalent CHP plant.

In case of flue gas condensation, excess condensate may be upgraded to high quality water useful for technical purposes such as boiler water or for covering water losses of the district-heating network.

Typical capacities

Large scale CHP:	$> 100 \text{ MW}_{\text{th input}}$ ($\sim > 25 \text{ MW}_e$)
Medium scale CHP:	$25 - 100 \text{ MW}_{\text{th input}}$ ($\sim 6-25 \text{ MW}_e$)
Small scale CHP:	$1 - 25 \text{ MW}_{\text{th input}}$ ($\sim 0.1-6 \text{ MW}_e$)

The size classification for CHP's has been changed from previous editions of the catalogue. The boundary between small and medium-sized plants of $25 \text{ MW}_{\text{th input}}$ is selected based on the suppliers' experience. Large scale CHP may be constructed up to around $1000 \text{ MW}_{\text{th input}}$ and possibly even larger.

The capacities of CHP's supplying heat to district heating systems are primarily determined by the heat demands. Most plants are equipped with a facility to by-pass the turbine temporarily to increase the heat production at the expense of losing the electricity production; the by-pass is in use more often than it was 10-20 years ago.

For biomass HOP's the typical capacities are $1 - 50 \text{ MW}_{\text{th input}}$. The majority of district heating plants are below $15 \text{ MW}_{\text{th input}}$ with an average size of $5-6 \text{ MW}_{\text{th input}}$ dependent of the fuel [11].

Regulation ability and other power system services

The CHP's can operate in a large range (15% to 100% for once-through suspension fired boilers). Biomass plants with drum type boilers (typical for grate fired boilers) can be operated in the range from 40-100% load. The lower end of the range is defined by the ability to generate super heated steam at the required temperature to operate the turbine and obtain reasonable electricity efficiency. For heat production only, the boiler could go to lower load. The CHP-range is likely to broaden slightly in the future, but the technology appears to have limitations.

Large plants may be designed for optional operation in pure electrical mode (condensing mode) with slightly higher electrical efficiency but without heat production. The condensing ability is mainly seen in large plants over 130 MW_{th input} and primarily used today for large Pulverized Fuel (PF) plants.

Typical wood fired HOP's are regulated 25-100% of full capacity, without violating emission standards. The best technologies can be regulated 10-120% with fuel not exceeding 35% moisture content.

Straw fired HOP's should not be operated below approx. 40% of full load due to emission standards. Straw fired plants should accordingly be equipped with a heat accumulating tank allowing for optimal operational conditions.

Advantages/disadvantages

Some biomass resources, in particular straw, contain highly corrosive components such as chlorine which together with potassium forms deposits that are both corrosive and limits heat uptake. In order to avoid or reduce the risk of slagging and corrosion, boiler manufacturers have traditionally abstained from using similar steam pressure/temperatures in biomass-fired plants as in coal-fired plants. However, advances in materials and boiler design have enabled the newest plants to deliver fairly high steam data and power efficiencies. Straw fired boilers can be operated up to 540°C and wood fired boilers up to slightly above 560°C. In most cases the technical limits are somewhat above what is economically feasible. The availability of suited steam turbines might limit the steam temperature for smaller sized plants.

Space requirements

Generally, in the catalogue, all the investigated biomass plants are designed and priced with a very small fuel storage facility. Typically, it is sized to last for two days of full load operation. The size of the storage has for some fuels a major impact on the totally required space (area) and it also can have a serious impact on the total CAPEX; to avoid this influence the store is kept small. In order to calculate CAPEX for a different size of the store, the tables contain an entry called 'Fuel storage specific cost in excess of 2 days (M€/MW_{th input}/storage day) for biomass fuels.

The area to be used for the buildings containing the process equipment is estimated in various ways. Very little additional area is added, say for administration, canteen, garages, work shop, etc. independent of the size of the plant. Further to this, some additional area to be used for other fuel handling, manoeuvring and weighing of trucks, parking of vehicles, roads and other free area. In total, it is ensured to have a reasonable percentage of area usage.

Despite that the largest plants (wood chips and pellets) are so large that a harbour facility is most appropriate, this is not included neither in space requirements nor in cost in the data tables. Other infrastructure facilities like a rail road for fuel transport are not considered.

Environment

The main ecological footprints from biomass combustion are persistent toxicity, climate change (GHG potential), and acidification. However, the footprints are considered small [1]. It is, however, an area of both major concern and discussion. Further to this is also added a concern on the sustainability of using in particular wood-like biomasses for power production. It is not the intent of this catalogue to initiate such a discussion but merely to mention that biomass fuelled plants can reduce GHG emissions considerably compared to fossil fuel fired plants, but it is still discussed if it resource-wise globally is a viable long term solution.

Modern flue gas cleaning systems will typically include the following processes: DeNO_x - ammonia injection (SNCR) or catalytic (SCR), SO₂ capture by injection of lime or the use of another SO₂ absorbing system, dust abatement by bag house filters.

NO_x emissions may be reduced, by about 60-70%, by selective non-catalytic reduction (SNCR) on wood chips fired boilers and 30-40% on straw fired boilers. NO_x emission may be reduced by 80-90% by selective catalyst (SCR). SNCR is a relatively low-cost solution but it is not necessarily applicable for a boiler subject to large load variations and constructed with high cooling rates and super heaters in the area most suitable for ammonia injection. The SCR solution requires installation of a catalyst which can be either a high temperature location near or in the boiler (downstream a particle filter) or it could be a much more expensive tail-end solution requiring re-heat of the flue gas. Removal of particles is preferred to limit poisoning of the catalyst that could quickly reduce its activity.

Due to the cost of the catalyst SCR is used mainly at large facilities. NO_x emission limit values are also lower for large facilities, giving further incentive to use SCR. SCR is rarely used in HOP because of their relatively small size, and their ability to reach below the NO_x emission limit values without using SCR.

The limit values for NO_x emissions are expected to be gradually tightened over time in the future. The technology in terms of combustion control, boiler design and improvements in the SNCR technology may relieve the need of SCR, but the application of SCR is nonetheless expected to increase in the future.

This is reflected in the datasheets by adding the cost of a tail-end DeNO_x to the medium (and larger) plants at a certain point in the future. Application of SCR in the respective scenarios appears from the notes.

Future plants above a certain capacity are required to have monitoring of air emissions of mercury, Hg. Generally, Hg is not a problem in straw fired units since Hg is oxidized by the chlorine in fuel and captured in the bag filter. Wood fired units might have a challenge with Hg if fired with woodchips from certain regions and only cleaning the flue gases with an electrostatic precipitator, ESP.

The EU Industrial Emission Directive (IED) [4], the directive on medium combustion plants [6], the BAT reference note on large combustion plants [5], the Danish guideline (Luftvejledning), [7], and air dispersion modelling

make up the basis for determining the emission limits for a specific plant in Denmark. It is expected that new, lower emission limits will be introduced with the future legislation initiated by the EU.

The emissions in the Data Sheets from 2020 and in the following years are based on proposed limits in the coming Best Available Technologies Air Emission Levels (BAT AELs) introduced by the EU BREF document for Large Combustion Plants [5] that is expected to come into force as of 2020. For small and medium scale plants, similar EU legislation is expected to come into force in the same timeframe, [6]. It is noted that emission limit values (ELV) for biomass plants are linked to the thermal input to the boiler in MW. More stringent requirements are valid for plants above 50 MW^{th input} according to the EU IED [4] and air emission levels of the EU reference note on best available technique of large combustion plants, LCP BREF AEL [5].

Biomass units produce four sorts of residues: Flue gas, fly ash, bottom ash and possibly condensate from flue gas condensation.

All bottom ash and most fly ash from straw firing is recycled to farmland as a fertilizer.

Almost all ash from wood firing is deposited in landfills. Research is ongoing on how to meet environmental acceptance limits for recycling the ash to forests.

The condensate water from wood firing is usually treated to remove heavy metals, particularly cadmium, so that its content reaches 3 milligrams per m³, or the level required for its discharge, which is usually the local municipal sewage system. The treatment may involve pH-adjustment, addition of polymers and flocculants and the use of belt filters for separation of the generated sludge. The treatment residue (sludge) must be deposited in a safe landfill. As described in the Introduction, condensate treatment may include electro deionization (EDI) and reverse osmosis to produce water that is virtually free of salts and pollutants. Hereby, it may be discharged to recipient or used for industrial purposes, such as topping up the water losses of the DH network. The condensate treatment is facilitated if an efficient particle separator is installed in the flue gas path upstream the flue gas condensation stage.

Condensate from straw-firing may be clean enough to be expelled without cleaning, since almost all cadmium is withheld with the fly ash in the bag filter.

Research and development perspectives

Research is ongoing in many areas relevant for bio mass units, e.g.:

Both CHP and HOP:

- Reduce the cost of fuel, by improved collection and pre-treatment, better characterisation and measurement methods.
- Improved combustion process for reduction of CO (that will also affect other unburned components e.g. PAH), NO_x, particles and SO₂
- Further development of secondary techniques for reduction of emissions of particles, aerosols, cadmium, NO_x and SO₂

- Improve boiler design and control of ammonia injection to allow efficient use of SNCR for deNO_x as an alternative to tail end SCR.
- Environmentally safe recycling of ashes to forestry; e.g. by pellets to ensure slow release of nutrients, alternatively recovery of potassium for generation of potassium fertilizer
- Cleaning condensate for reuse and discharge to recipient

CHP:

- Improve control ability against fuel variations
- Reduce corrosion, in particular high-temperature corrosion
- Reduce slagging
- Improve steam cycle by introduction of steam reheat (>75 MW_{th input})
- Optimise the use of ORC systems in a Danish environment, including collection of operating experiences

HOP:

- Handling and combustion of new types of fuels, such as energy crops and garden/park waste

New technology:

Instead of implementing the combustion process in the boiler vessel, an alternative Danish solution has been developed and demonstrated in three plants until now. The Dall Energy Biomass Furnace combines updraft gasification and gas combustion. Hereby several advantages are achieved: The plant becomes simpler and possibly less expensive, the reactor is fuel flexible, the emissions are reduced and the furnace can regulate between 10-100 % according to the supplier.

The Biomass Furnace delivers hot flue gas to a commercial boiler. This concept is promising and has already drawn attention in the energy sector.

It was originally used for HOP, but one plant under construction (2018) includes ORC that makes the technology useful as CHP.

Prediction of performance and cost

Both biomass CHPs and HOPs represent today well-known technologies that has been erected in reasonably large numbers. Improvements can still be expected, but only at an incremental level. Therefore, the technology belongs to Category 4: Commercial technologies, with large deployment.

Development within this area is driven by possible prospects for being able to earn money and therefore also by the expected future prices on heat and power. Twenty years ago electric power was a valuable product and thus it was beneficial to aim at as high an electrical efficiency that could possibly be achieved. Today, power prices are in periods below prices of heat and this has a big impact on investment decisions; it is no longer certain that the electrical efficiency should be as high as possible. In years to come the difference between the units with highest electricity efficiency commercially available and the electricity efficiency of solutions actually bought will increase.

In the low capacity range (less than 25-30 MW_{th input}) the scale of economics effect is quite considerable and there is a very significant economical difference between steam (and thereby electricity) producing boilers and hot water (DH only) producing boilers. In particular boilers for the latter type can be series produced and are thus much cheaper than a boiler for producing super-heated steam for power production of similar size.

Wood chips heat only boilers (hot water) up to 20 MW thermal input have become very popular; they are produced in a more or less serial production and this lowers both capital and O&M cost.

Uncertainty

Biomass plants are fully commercial (Category 4) with small uncertainties for performances and costs. The trend of the recent years towards building large plants (>110 MW_{th input} for CHPs and >25 MW_{th input} for HOPs) including steam reheat (CHP only), absorption heat pumps for enhanced flue gas condensation, humidification of combustion air, more advanced flue gas cleaning etc., introduces a moderate increase of uncertainty. These advanced solutions are expected to be in Category 4 within a few years.

The real cost uncertainty is related to what extent the emission limits will be tightened. Further tightening of emissions requires development of more efficient combustions processes in the boiler and secondary flue gas cleaning systems. This will increase the capital costs and O&M cost.

Examples of market standard available technology

CHPs:

- Fyn Power Plant (DK), Unit 8; commissioned in 2009; 120 MW_{th input}, 35 MW_e; 84 MW district heat. 170,000 tonnes of straw per year. Equipped with flue gas condenser. Retrofitted with SCR tail end.
- Sleaford (UK) commissioned 2014, 115 MW_{th input} (straw/wood chips), 38.5 MW_e, net electrical efficiency 33%. 240,000 tonnes of straw per year.
- Lisbjerg (DK) commissioned 2016, 110 MW_{th input}. Energy efficiency 103% at CHP mode. Equipped with tail end SCR, combustion air humidification and flue gas condenser.
- Snetterton (UK), commission year 2017, 130 MW_{th input} (straw/wood chips), 44 MWe, net electrical efficiency 34%. 270,000 tonnes of straw per year.
- Avedøre Power Plant (DK) Unit 2 is a multi-fuel CHP power plant that can operate on wood pellets, straw, oil (HFO), and natural gas. It was commissioned in 1999. It has a 100 MW_{th input} separate biomass-fired boiler (ultra-super critical steam data – 290 bar, 540°C) supplying steam in parallel with the main boiler; 170,000 tonnes of straw per year. When the plant is running 100% on wood pellets in the main boiler and 100% straw, it is producing 425 MW_e in condensing mode, and 355 MW_e and 485 MW_{th} heat output in back pressure CHP mode.
- In Denmark the plants Studstrup 3 and Avedøre 1 have recently been converted from coal firing into wood pellets firing. In Skærbæk a gas fired unit is converted into firing wood chips by installing 2 new grate fired boilers supplying steam to the existing turbine
- There are a few new large CHP plants expected to be built in the coming years. The currently known projects are Amager 4 and Asnæs 6.
- Sindal, under construction 2018, Dall boiler with ORC, heat output 5 MW_{th}, electricity generation 800 kW_e

HOPs:

- Hobro district heating (DK) commissioned 2017, 11.3 MW_{th} input (wood chips) and 13 MW_{th} output
- Hasle district heating (DK) commissioned 2017, 12 MW_{th} input (wood chips) and 15 MW_{th} output
- Lemvig district heating (DK) commissioned 2016, 8 MW_{th} input (wood chips) and 10.4 MW_{th} output
- Sønderborg district heating (DK) installed a Dall Energy Biomass Furnace (varied biomass) commissioned 2015, 9 MW_{th} input and 9 MW_{th} output.
- Bogense utility company (DK) installed a Dall Energy Biomass Furnace (varied biomass) commissioned 2011, 8 MW_{th} input and 8 MW_{th} output.
- Hvidebæk district heating (DK) commissioned 2017, 7 MW_{th} input (straw) and 7 MW_{th} output
- Ørnhøj Grønbjerg district heating (DK) commissioned 2017, 1.7 4 MW_{th} input (straw) and 1.5 MW_{th} output
- Nexø halmvarmeværk (DK) commissioned 2016, with flue gas condensation and heatpump, 12 MW_{th} input (straw) and 15 MW_{th} output

Additional remarks

Despite the observation that straw is a much more difficult fuel than wood (chips/pellets) the electricity efficiencies of CHP's are almost equal. This reflects the fact that the development of straw-fired CHP's for many years was driven by power utilities focusing on high electricity efficiencies.

The deployment of small and medium-sized biomass fired CHP plants in DK was largely inactive for some years after 2000, but changed conditions for DH is changing the situation. There are several trends in the area of new biomass CHP plants:

1. They are being built in large sizes, mainly because of a better plant economy, but also to accommodate for an increase in the DH market.
2. The electrical efficiency is not in focus due to low electricity prices.

References

- [1] "Life cycle assessment of Danish electricity and cogeneration", Energinet.dk, DONG Energy and Vattenfall, April 2010.
- [2] "Energy Technology_Perspectives", IEA report, 2012
- [3] Input and comments by Burmeister & Wain Energy, 2015
- [4] Industrial Emissions Directive (IED), Directive 2010/75/EU of the European Parliament and of the Council of 24 November 2010 on industrial emissions (integrated pollution prevention and control). Available at <http://ec.europa.eu/environment/industry/stationary/ied/legislation.htm> (last visited 01.08.2018).
- [5] Joint Research Centre, Institute for Prospective Technological Studies, Sustainable Production and Consumption Unit, European IPPC Bureau, Best Available Techniques (BAT) Reference Document for Large Combustion Plants, 2017. (LCP BREF)
- [6] EU MCP Directive, DIRECTIVE (EU) 2015/2193 OF THE EUROPEAN PARLIAMENT AND OF THE COUNCIL of 25 November 2015 on the limitation of emissions of certain pollutants into the air from medium combustion plants, <https://eur-lex.europa.eu/legal-content/EN/TXT/PDF/?uri=CELEX:32015L2193&from=EN>.

- [7] Danish environmental protection agency, Luftvejledningen, Begrænsning af luftforurening fra virksomheder, Vejledning fra miljøstyrelsen Nr. 2 2001, <https://www2.mst.dk/udgiv/publikationer/2001/87-7944-625-6/pdf/87-7944-625-6.pdf> (air guideline, in Danish)
- [8] Dansk Fjernvarme, Input and comments 2015, 2017, not published
- [9] Videncenter for Halm og Flis-fyring. Træ til energiformål, 1999.
- [10] Danish Environmental Protection Agency, "En opdateret analyse af Danmarks muligheder for at reducere emissionerne af NO_x" (Updated analysis of Denmark's options to reduce NO_x emissions; in Danish), 2009.
- [11] Danish Energy Agency, Energiproducenttællingen 2016.

Data sheets Wood Chips CHP, small

Technology	Small Wood Chips CHP, 20 MW feed									
	2015	2020	2030	2050	Uncertainty (2020)		Uncertainty (2050)		Note	Ref
Energy/technical data					Lower	Upper	Lower	Upper		
Generating capacity for one unit (MWe)	2.9	2.9	2.9	2.8	2.8	2.9	2.7	2.9	A	
Electricity efficiency, net (%), name plate	14.3	14.3	14.3	14.0	14	14	14	14	A, H	1
Electricity efficiency, net (%), annual average	13.5	13.5	13.6	13.3	13	14	12	14	A, H	1
Heat efficiency, net (%), name plate	97.3	97.3	97.3	97.6	71	98	69	98	B, H	1
Heat efficiency, net (%), annual average	98.1	98.1	98.0	98.3	72	98	71	99	B, H	1
Additional heat potential with heat pumps (% of thermal input)	2.0	2.0	2.0	2.0	2	28	2	30	C	1
Cb coefficient (40°C/80°C)	0.15	0.15	0.15	0.14	0.14	0.15	0.14	0.15		
Cv coefficient (40°C/80°C)	1	1	1	1	1	1	1	1	I	
Forced outage (%)	3	3	3	3	3	3	3	3		
Planned outage (weeks per year)	3.0	3.0	3.0	3.0	2.6	3.5	2.3	3.8		
Technical lifetime (years)	25	25	25	25	20	35	20	35		1
Construction time (years)	1	1	1	1	0.5	1.5	0.5	1.5		1
Space requirement (1000 m ² /MWe)	0.7	0.7	0.7	0.7	0.6	0.8	0.5	0.9		
Primary regulation (% per 30 seconds)	NA	NA	NA	NA	NA	NA	NA	NA		
Secondary regulation (% per minute)	10	10	10	10	10	10	10	10	D	1
Minimum load (% of full load)	20	20	20	20	20	20	20	20	D	1
Warm start-up time (hours)	0.25	0.25	0.25	0.25	0.25	0.25	0.25	0.25	G	1
Cold start-up time (hours)	0.5	0.5	0.5	0.5	0.5	0.5	0.5	0.5		1
Environment										
SO ₂ (degree of desulphuring, %)	98.0	98.0	98.0	98.0	94.9	99.0	98.0	99.0	F	1
NO _x (g per GJ fuel)	90	63	41	32	41	81	20	41	F	1
CH ₄ (g per GJ fuel)	16	11	8	4	4	16	2	16	F	1
N ₂ O (g per GJ fuel)	1	1	1	1	1	3	0	1	F	1
Particles (g per GJ fuel)	2.0	0.3	0.3	0.3	0.1	2.0	0.1	1.0	F	1
Financial data										
Nominal investment (M€/MWe)	6.7	6.5	6.2	6.0	5.7	7.7	4.7	8.1	E, J, K	1
- of which equipment	4.1	4.0	3.8	3.8	3.5	4.8	2.9	5.2	K	
- of which installation	2.5	2.5	2.3	2.2	2.1	2.9	1.8	3.0	K	
Fixed O&M (€/MWe/year)	292,700	288,900	280,500	277,900	252,000	331,000	215,600	347,000		
Variable O&M (€/MWh _e)	7.8	7.8	7.7	7.9	6.6	8.9	5.9	9.8		
Technology specific data										

Steam reheat	None	None	None	None	None	None	None	None		
Flue gas condensation	Yes	Yes	Yes	Yes	No	Yes	No	Yes		
Combustion air humidification	Yes	Yes	Yes	Yes	No	Yes	No	Yes		
Nominal investment (M€/MW fuel input)	0.95	0.93	0.88	0.84	0.81	1.09	0.66	1.14	J, K	1
- of which equipment	0.59	0.58	0.55	0.53	0.50	0.68	0.41	0.72	K	
- of which installation	0.36	0.35	0.33	0.30	0.31	0.41	0.25	0.42	K	
Fixed O&M (€/MW input/year)	41,800	41,200	40,200	39,000	35,300	47,800	29,600	50,100		
Variable O&M (€/MWh input)	1.1	1.1	1.1	1.1	0.9	1.3	0.8	1.4		
Fuel storage specific cost in excess of 2 days (M€/MW input/storage day)	0.020	0.020	0.019	0.017	0.017	0.023	0.014	0.023	K	

Notes:

- A The plant is directly producing hot water for District Heating by burning fuel on a grate. The electric power is produced by an ORC module (Organic Rankine Cycle; Waste Heat Recovery - WHR). Refer for instance to the following link for further information about technology and suppliers: http://www.enova.no/upload_images/36AC689098414B05A7112FA2EE985BDA.pdf . This is low temperature and low efficiency electric power but at an affordable price.
- B Boilers up to 20 MW fuel input for hot water production are more or less standardized products with a high degree of fuel flexibility (type of biomass, humidity etc.)
- C There are plants of this type with up to 110 % efficiency using flue gas condensation with moist wood chips and close to 120 % efficiency with both flue gas condensation and absorption heat pumps activated. The colder the return temperature of the district heating, the higher the total efficiency at direct condensation. Direct condensation and combustion air humidification are included in all cases except in lower range of 2020 and 2050.
Secondary regulation normally relates to power production; for this type of plant it may not be of importance. Though, the load control of the heat production is important and most units will perform better than the figure shown. Also, minimum load could be substantially lower.
- E Since electricity generation is only a secondary objective for minor heat producers, it may make more sense to relate the total investment only to the heat production capacity.
- F It is to be expected that necessary DeNOx can be accomplished using SNCR, except where anticipated emission levels are below 40 g/GJ
- G Warm start is starting with a glowing fuel layer on the grate.
- H The total efficiency is the sum of electricity efficiency and heat efficiency, applicable for "name plate" and "annual average", respectively. The "annual average" electricity efficiency is lower than "name plate" due to turbine outages and other incidents. The resulting lost power production is recovered as heat. This is why "annual average" heat efficiency is higher than "name plate" heat. Efficiencies refer to lower heating value. The parasitic electricity consumption has been subtracted in the listed electricity efficiencies.
- I Cv=1 describes turbine by-pass operation. During operation the turbine can be by-passed fully or partly for direct district heating production, at operator choice.
- J Investment applies to a standard plant. There could be cost related to the actual project or site that adds to the total investment, e.g. additional fuel storage, facilities for chipping of logs, conditions for foundation and harbour facilities. Financial data and Technological specific data are essentially the total cost either divided by the electric net capacity, i.e. corresponding to the indicated name plate efficiencies, or by the thermal input. This is to indicate that new plants may not fully take advantage of the technical capabilities for full electricity production capacity. The two cost for electricity and thermal input, respectively, are not to be added up!
- K Note that investments include only two days fuel storage, and more may be optimal, depending on fuel supply opportunities and heat supply obligations, amongst other things.
The additional investment is listed in the bottom row.

References

1 Rambøll Danmark, internal model and evaluation based on either existing projects, supplier offers, or pre-project studies.

Data sheets Wood Chips CHP, medium

Technology	Medium Wood Chips CHP, 80 MW feed									
	2015	2020	2030	2050	Uncertainty (2020)		Uncertainty (2050)		Note	Ref
Energy/technical data					Lower	Upper	Lower	Upper		
Generating capacity for one unit (MWe)	23.1	23.1	23.2	22.8	21.8	30.9	22.4	31.8	A	
Electricity efficiency, net (%), name plate	28.9	28.9	29.0	28.5	27	39	28	40	A, H, F	1
Electricity efficiency, net (%), annual average	27.4	27.4	27.5	27.0	25	37	25	38	A, H, F	1
Heat efficiency, net (%), name plate	82.1	82.1	81.9	82.5	46	84	43	83	B, H	1
Heat efficiency, net (%), annual average	83.5	83.5	83.4	83.9	49	86	46	85	B, H	1
Additional heat potential with heat pumps (% of thermal input)	2.0	2.0	2.0	2.0	2	28	2	30	C	1
Cb coefficient (40°C/80°C)	0.35	0.35	0.35	0.35	0.33	0.47	0.34	0.48		
Cv coefficient (40°C/80°C)	1	1	1	1	1	1	1	1	I	
Forced outage (%)	3	3	3	3	3	3	3	3		
Planned outage (weeks per year)	3.0	3.0	3.0	3.0	2.6	3.5	2.3	3.8		
Technical lifetime (years)	25	25	25	25	20	35	20	35		1
Construction time (years)	2.5	2.5	2.5	2.5	2	3	1.5	3		1
Space requirement (1000 m ² /MWe)	0.2	0.2	0.2	0.2	0.2	0.2	0.2	0.3		
Primary regulation (% per 30 seconds)	NA	NA	NA	NA	NA	NA	NA	NA		
Secondary regulation (% per minute)	4	4	4	4	4	4	4	4	D	1
Minimum load (% of full load)	20	20	20	20	20	20	20	20		
Warm start-up time (hours)	2	2	2	2	2	2	2	2	E+G	1
Cold start-up time (hours)	8	8	8	8	8	8	8	8		1
Environment										
SO ₂ (degree of desulphuring, %)	98.0	98.0	98.0	98.0	94.9	99.0	98.0	99.0	F	1
NO _x (g per GJ fuel)	90	72	41	24	41	81	20	41	F	1
CH ₄ (g per GJ fuel)	3	2	2	1	1	3	0	3	F	1
N ₂ O (g per GJ fuel)	1	1	1	1	1	3	0	1	F	1
Particles (g per GJ fuel)	2.0	0.3	0.3	0.3	0.1	2.0	0.1	1.0	F	1
Financial data										
Nominal investment (M€/MWe)	3.7	3.6	3.5	3.3	3.1	4.3	2.5	4.5	J, K	1
- of which equipment	2.5	2.4	2.3	2.2	2.0	2.9	1.7	3.0	K	
- of which installation	1.2	1.2	1.1	1.1	1.0	1.4	0.9	1.5	K	
Fixed O&M (€/MWe/year)	158,400	153,600	144,000	132,800	133,400	137,000	101,400	123,000		
Variable O&M (€/MWh _e)	3.8	3.8	3.8	3.9	3.3	4.4	2.9	4.9		
Technology specific data										

Steam reheat	None	None	None	None	None	Yes	None	Yes		
Flue gas condensation	Yes	Yes	Yes	Yes	No	Yes	No	Yes		
Combustion air humidification	Yes	Yes	Yes	Yes	No	Yes	No	Yes		
Nominal investment (M€/MW fuel input)	1.08	1.05	1.00	0.94	0.88	1.24	0.72	1.28	J, K	1
- of which equipment	0.72	0.71	0.67	0.64	0.58	0.83	0.47	0.87	K	
- of which installation	0.36	0.35	0.33	0.30	0.30	0.41	0.25	0.41	K	
Fixed O&M (€/MW input/year)	45,800	44,369	41,766	37,793	37,323	51,473	28,349	48,834		
Variable O&M (€/MWh input)	1.1	1.1	1.1	1.1	0.9	1.3	0.8	1.4		
Fuel storage specific cost in excess of 2 days (M€/MW_input/storage day)	0.015	0.015	0.014	0.013	0.013	0.017	0.010	0.017	K	

Notes:

- A The boiler in the plant is a grate fired boiler producing steam to be used in a subsequent back pressure steam turbine. Though a grate is reasonable flexible with respect to combusting different fuels the fuel feed system will be dependent on the type of fuel. It is to be expected that it is necessary with a specific DeNOx plant (SNCR might not be sufficient).
- B Through a turbine by-pass all the produced steam energy is used for District Heat production.
- C Plants of this type may achieve up to 110 % efficiency using flue gas condensation with moist wood chips and 115 % efficiency with both flue gas condensation and absorption heat pumps activated. The colder the return temperature of the district heating, the higher the total efficiency at direct condensation. Direct condensation and combustion air humidification are included in all cases except in lower range of 2020 and 2050.
- D Secondary regulation normally relates to power production; for this type of plant it may not be of importance since load will normally follow heat consumption.
- E A limiting factor for the hot and cold start-up times is the size of the hot water tank (deaerator).
- F It is to be expected that necessary DeNOx can be accomplished using SNCR, except where anticipated emission levels are below 40 g/GJ in which case SCR is used with slight adverse effect on electricity efficiency.
- G Warm start is starting with a glowing fuel layer on the grate and a warm deaerator.
- H The total efficiency is the sum of electricity efficiency and heat efficiency, applicable for "name plate" and "annual average", respectively. The "annual average" electricity efficiency is lower than "name plate" due to turbine outages and other incidents. The resulting lost power production is recovered as heat. This is why "annual average" heat efficiency is higher than "name plate" heat. Efficiencies refer to lower heating value. The parasitic electricity consumption has been subtracted in the listed electricity efficiencies.
- I The Cv value does not exist for plants with a back pressure turbine or an ORC turbine
- J Investment applies to a standard plant. There could be cost related to the actual project or site that adds to the total investment, e.g. additional fuel storage, facilities for chipping of logs, conditions for foundation and harbour facilities. Financial data and Technological specific data are essentially the total cost either divided by the electric net capacity, i.e. corresponding to the indicated name plate efficiencies, or by the thermal input. This is to indicate that new plants may not fully take advantage of the technical capabilities for full electricity production capacity. The two cost for electricity and thermal input, respectively, are not to be added up!
- K Note that investments include only two days fuel storage, and more may be optimal, depending on fuel supply opportunities and heat supply obligations, amongst other things. The additional investment is listed in the bottom row.

References

- 1 Rambøll Danmark, internal evaluation based on either existing projects, supplier offers, or pre-project studies.

Data sheets Wood Chips CHP, large

Technology	Large Wood Chips CHP, 600 MW feed									
	2015	2020	2030	2050	Uncertainty (2020)		Uncertainty (2050)		Note	Ref
Energy/technical data					Lower	Upper	Lower	Upper		
Generating capacity for one unit (MWe)	176.5	176.9	177.5	174.4	162.9	235.0	170.9	242.6	A	
Electricity efficiency, net (%), name plate	29.4	29.5	29.6	29.1	27	39	28	40	A, H	1
Electricity efficiency, net (%), annual average	27.9	28.0	28.1	27.6	24	37	26	38	A, H	1
Heat efficiency, net (%), name plate	82.0	82.2	82.0	82.6	45	84	43	83	B, H	1
Heat efficiency, net (%), annual average	83.5	83.6	83.5	84.0	47	86	46	85	B, H	1
Additional heat potential with heat pumps (% of thermal input)	2.0	1.9	1.9	1.9	2	30	2	30	C	1
Cb coefficient (40°C/80°C)	0.36	0.36	0.36	0.35	0.33	0.48	0.34	0.49		
Cv coefficient (40°C/80°C)	1	1	1	1	1	1	1	1		
Forced outage (%)	3	3	3	3	3	3	3	3		
Planned outage (weeks per year)	3.0	3.0	3.0	3.0	2.6	3.5	2.3	3.8		
Technical lifetime (years)	25	25	25	25	20	35	20	35		1
Construction time (years)	5	5	5	5	4.5	5.5	4	5.5		1
Space requirement (1000 m2/MWe)	0.08	0.08	0.08	0.09	0.07	0.10	0.06	0.11		1
Regulation										
Primary regulation (% per 30 seconds)	2	2	2	2	2	2	2	2		
Secondary regulation (% per minute)	4	4	4	4	4	4	4	4	D	1
Minimum load (% of full load)	45	45	45	45	45	45	45	45		
Warm start-up time (hours)	2	2	2	2	2	2	2	2	E+G	1
Cold start-up time (hours)	12	12	12	12	12	12	12	12		1
Environment										
SO ₂ (degree of desulphuring, %)	98.0	98.0	98.0	98.0	94.9	99.0	98.0	99.0	F	1
NO _x (g per GJ fuel)	30	24	20	12	12	30	8	20	F	1
CH ₄ (g per GJ fuel)	3	2	2	1	1	3	0	3	F	1
N ₂ O (g per GJ fuel)	10	8	6	5	5	10	3	10	F	1
Particles (g per GJ fuel)	0.3	0.3	0.3	0.3	0.1	2.0	0.1	1.0	F	1
Financial data										
Nominal investment (M€/MWe)	3.5	3.4	3.2	3.0	2.9	4.1	2.4	4.2	J, K	1
- of which equipment	2.3	2.2	2.1	2.0	1.8	2.7	1.5	2.7	K	
- of which installation	1.2	1.2	1.1	1.0	1.0	1.4	0.9	1.4	K	
Fixed O&M (€/MWe/year)	100,500	97,600	92,300	86,300	86,600	89,600	67,200	81,300		
Variable O&M (€/MWh _e)	3.8	3.8	3.7	3.8	3.2	4.3	2.9	4.8		
Technology specific data										
Steam reheat	None	None	None	None	None	Yes	None	Yes		
Flue gas condensation	Yes	Yes	Yes	Yes	No	Yes	No	Yes		

Combustion air humidification	Yes	Yes	Yes	Yes	No	Yes	No	Yes		
Nominal investment (M€/MW fuel input)	1.03	1.00	0.95	0.88	0.85	1.20	0.70	1.21	J, K	1
- of which equipment	0.66	0.65	0.62	0.58	0.54	0.78	0.44	0.79	K	
- of which installation	0.36	0.35	0.34	0.30	0.31	0.42	0.25	0.42	K	
Fixed O&M (€/MW input/year)	29,500	28,800	27,300	25,100	24,300	33,900	19,100	32,900		
Variable O&M (€/MWh input)	1.1	1.1	1.1	1.1	0.9	1.3	0.8	1.4		
Fuel storage specific cost in excess of 2 days (M€/MW_input/storage day)	0.010	0.010	0.009	0.008	0.009	0.012	0.007	0.012	K	

Notes:

- A The boiler in the plant is a circulating fluid bed boiler (CFB) producing steam to be used in a subsequent back pressure turbine without steam re-heat.
- B Through a turbine by-pass all the produced steam energy can be used for District Heat production.
- C Plants of this type may achieve up to 110 % efficiency using flue gas condensation with moist wood chips and 115 % efficiency with both flue gas condensation and absorption heat pumps activated. The colder the return temperature of the district heating, the higher the total efficiency at direct condensation. Direct condensation and combustion air humidification are included in all cases except in lower range of 2020 and 2050.
- D Secondary regulation normally relates to power production; for this type of plant it may not be of importance since load will normally follow heat consumption.
- E A limiting factor for the hot and cold start-up times is the size of the hot water tank (deaerator). Warm start-up time is particularly low for fluid bed types of plants.
- F It is to be expected that the NOx level is low from the CFB, and that the necessary DeNOx can be accomplished using SNCR, except where anticipated emission levels are below 20 g/GJ, in which case SCR is used.
- G Warm start is starting with a glowing bed and a warm deaerator.
- H The total efficiency is the sum of electricity efficiency and heat efficiency, applicable for "name plate" and "annual average", respectively. The "annual average" electricity efficiency is lower than "name plate" due to turbine outages and other incidents. The resulting lost power production is recovered as heat. This is why "annual average" heat efficiency is higher than "name plate" heat. Efficiencies refer to lower heating value. The parasitic electricity consumption has been subtracted in the listed electricity efficiencies.
- I Financial data and Technological specific data are essentially the total cost either divided by the electric net capacity or by the net heat capacity, i.e. corresponding to the indicated name plate efficiencies. This is to indicate that new plants may not fully take advantage of the technical capabilities for either full electricity production capacity or heat production capacity. The two cost for electricity and heat, respectively, are not to be added up!
- J Investment applies to a standard plant. There could be cost related to the actual project or site that adds to the total investment, e.g. additional fuel storage, facilities for chipping of logs, conditions for foundation and harbour facilities. Financial data and Technological specific data are essentially the total cost either divided by the electric net capacity, i.e. corresponding to the indicated name plate efficiencies, or by the thermal input. This is to indicate that new plants may not fully take advantage of the technical capabilities for full electricity production capacity. The two cost for electricity and thermal input, respectively, are not to be added up!
- K Note that investments include only two days fuel storage, and more may be optimal, depending on fuel supply opportunities and heat supply obligations, amongst other things. The additional investment is listed in the bottom row.

References

- 1 Rambøll Danmark, internal evaluation based on either existing projects, supplier offers, or pre-project studies.

Data sheets Wood Pellets CHP, small

Technology	Small Wood Pellets CHP, 20 MW feed									
	2015	2020	2030	2050	Uncertainty (2020)		Uncertainty (2050)		Note	Ref
Energy/technical data					Lower	Upper	Lower	Upper		
Generating capacity for one unit (MWe)	3.0	3.0	3.0	3.0	2.9	3.0	2.9	3.0	A	
Electricity efficiency, net (%), name plate	15.1	15.1	14.9	14.9	15	15	15	15	A, H	1
Electricity efficiency, net (%), annual average	14.4	14.4	14.2	14.2	13	14	13	14	A, H	1
Heat efficiency, net (%), name plate	82.2	82.2	82.4	82.4	71	83	72	83	B, H	1
Heat efficiency, net (%), annual average	83.0	83.0	83.1	83.1	73	84	73	84	B, H	1
Additional heat potential with heat pumps (% of thermal input)	1.7	1.7	1.7	1.7	2	12	2	12	C	1
Cb coefficient (40°C/80°C)	0.18	0.18	0.18	0.18	0.18	0.19	0.18	0.18		
Cv coefficient (40°C/80°C)	1	1	1	1	1	1	1	1	I	
Forced outage (%)	3	3	3	3	3	3	3	3		
Planned outage (weeks per year)	3.0	3.0	3.0	3.0	2.6	3.5	2.3	3.8		
Technical lifetime (years)	25	25	25	25	20	35	20	35		1
Construction time (years)	1	1	1	1	0.5	1.5	0.5	1.5		1
Space requirement (1000 m ² /MWe)	0.5	0.5	0.5	0.5	0.4	0.6	0.4	0.6		
Primary regulation (% per 30 seconds)	NA	NA	NA	NA	NA	NA	NA	NA		
Secondary regulation (% per minute)	10	10	10	10	10	10	10	10	D	1
Minimum load (% of full load)	20	20	20	20	20	20	20	20	D	1
Warm start-up time (hours)	0.25	0.25	0.25	0.25	0.25	0.25	0.25	0.25	G	1
Cold start-up time (hours)	0.5	0.5	0.5	0.5	0.5	0.5	0.5	0.5		1
Environment										
SO ₂ (degree of desulphuring, %)	98.3	98.3	98.3	98.3	95.6	99.1	98.3	99.1	F	1
NO _x (g per GJ fuel)	90	54	35	28	35	70	18	35	F	1
CH ₄ (g per GJ fuel)	0	0	0	0	0	0	0	0	F	1
N ₂ O (g per GJ fuel)	1	1	1	1	1	3	0	1	F	1
Particles (g per GJ fuel)	2.0	0.3	0.3	0.3	0.1	2.0	0.1	1.0	F	1
Financial data										
Nominal investment (M€/MWe)	6.3	6.2	6.2	5.6	5.4	7.6	4.7	7.7	E,J,K	1
- of which equipment	4.1	4.0	4.1	3.8	3.5	5.0	3.2	5.1	K	
- of which installation	2.2	2.1	2.1	1.9	1.9	2.5	1.6	2.6	K	
Fixed O&M (€/MWe/year)	280,900	275,900	274,800	257,800	243,500	322,400	204,700	329,400		
Variable O&M (€/MWh _e)	3.4	3.4	3.4	3.4	2.9	3.9	2.6	4.3		
Technology specific data										

Steam reheat	None	None	None	None	None	None	None	None		
Flue gas condensation	Yes	Yes	Yes	Yes	No	Yes	No	Yes		
Combustion air humidification	Yes	Yes	Yes	Yes	No	Yes	No	Yes		
Nominal investment (M€/MW fuel input)	0.96	0.93	0.93	0.84	0.81	1.14	0.71	1.15	E,J,K	1
- of which equipment	0.63	0.61	0.62	0.56	0.53	0.76	0.47	0.76	K	
- of which installation	0.33	0.32	0.31	0.28	0.28	0.38	0.23	0.39	K	
Fixed O&M (€/MW input/year)	42,500	41,700	41,100	38,500	35,700	49,100	30,000	49,500		
Variable O&M (€/MWh input)	0.51	0.51	0.51	0.51	0.43	0.59	0.38	0.64		
Fuel storage specific cost in excess of 2 days (M€/MW_input/storage day)	0.004	0.004	0.004	0.003	0.003	0.005	0.003	0.005	K	

Notes:

- A The plant is directly producing hot water for District Heating by burning fuel on a grate. The electric power is produced by an ORC module (Organic Rankine Cycle; Waste Heat Recovery - WHR). Refer for instance to the following link for further information about technology and suppliers: http://www.enova.no/upload_images/36AC689098414B05A7112FA2EE985BDA.pdf. This is low temperature and low efficiency electric power but at an affordable price.
- B Boilers up to 20 MW fuel input for hot water production are more or less standardized products with a high degree of fuel flexibility (type of biomass, humidity etc.)
- C There are plants of this type with up to 110 % efficiency using flue gas condensation with moist wood chips and close to 120 % efficiency with both flue gas condensation and absorption heat pumps activated. The colder the return temperature of the district heating, the higher the total efficiency at direct condensation. Direct condensation and combustion air humidification are included in all cases except in lower range of 2020 and 2050.
- D Secondary regulation normally relates to power production; for this type of plant it may not be of importance. Though, the load control of the heat production is important and most units will perform better than the figure shown. Also, minimum load could be substantially lower.
- E Since electricity generation is only a secondary objective for minor heat producers, it may make more sense to relate the total investment only to the thermal input.
- F It is anticipated that for the smaller units the supplier has a SNCR solution to avoid NOx emissions sufficiently. Little SO2, CH4 and N2O are emitted when combusting woody biomass.
- G Warm start is starting with a glowing fuel layer on the grate.
- H The total efficiency is the sum of electricity efficiency and heat efficiency, applicable for "name plate" and "annual average", respectively. The "annual average" electricity efficiency is lower than "name plate" due to turbine outages and other incidents. The resulting lost power production is recovered as heat. This is why "annual average" heat efficiency is higher than "name plate" heat. Efficiencies refer to lower heating value. The parasitic electricity consumption has been subtracted in the listed electricity efficiencies.
- I The Cv value does not exist for plants with a back pressure turbine or an ORC turbine
- J Investment applies to a standard plant. There could be cost related to the actual project or site that adds to the total investment, e.g. additional fuel storage, facilities for chipping of logs, conditions for foundation and harbour facilities. Financial data and Technological specific data are essentially the total cost either divided by the electric net capacity, i.e. corresponding to the indicated name plate efficiencies, or by the thermal input. This is to indicate that new plants may not fully take advantage of the technical capabilities for full electricity production capacity. The two cost for electricity and thermal input, respectively, are not to be added up!
- K Note that investments include only two days fuel storage, and more may be optimal, depending on fuel supply opportunities and heat supply obligations, amongst other things. The additional investment is listed in the bottom row.

References

1 Rambøll Danmark, internal evaluation based on either existing projects, supplier offers, or pre-project studies.

Data sheets Wood Pellets CHP, medium

Technology	Medium Wood Pellets CHP, 80 MW feed									
	2015	2020	2030	2050	Uncertainty (2020)		Uncertainty (2050)		Note	Ref
Energy/technical data					Lower	Upper	Lower	Upper		
Generating capacity for one unit (MWe)	24.1	24.1	23.9	23.9	23.2	32.5	23.5	32.7	A	
Electricity efficiency, net (%), name plate	30.2	30.2	29.8	29.8	29	41	29	41	A, H, F	1
Electricity efficiency, net (%), annual average	28.6	28.6	28.3	28.3	26	39	26	39	A, H, F	1
Heat efficiency, net (%), name plate	66.5	66.5	66.8	66.8	44	69	44	68	A, H, F	1
Heat efficiency, net (%), annual average	68.0	68.0	68.3	68.3	47	71	47	70	B, H	1
Additional heat potential with heat pumps (% of thermal input)	1.7	1.7	1.7	1.7	2	12	2	12	C	1
Cb coefficient (40°C/80°C)	0.45	0.45	0.45	0.45	0.44	0.61	0.44	0.61		
Cv coefficient (40°C/80°C)	1	1	1	1	1	1	1	1	I	
Forced outage (%)	3	3	3	3	3	3	3	3		
Planned outage (weeks per year)	3.0	3.0	3.0	3.0	2.6	3.5	2.3	3.8		
Technical lifetime (years)	25	25	25	25	20	35	20	35		1
Construction time (years)	1	1	1	1	0.5	1.5	0.5	1.5		1
Space requirement (1000 m ² /MWe)	0.2	0.2	0.2	0.2	0.2	0.2	0.1	0.2		
Primary regulation (% per 30 seconds)	NA	NA	NA	NA	NA	NA	NA	NA		
Secondary regulation (% per minute)	10	10	10	10	10	10	10	10	D	1
Minimum load (% of full load)	15	15	15	15	15	15	15	15		
Warm start-up time (hours)	0.25	0.25	0.25	0.25	0.25	0.25	0.25	0.25	E	1
Cold start-up time (hours)	8	8	8	8	8	8	8	8		1
Environment										
SO ₂ (degree of desulphuring, %)	98.3	98.3	98.3	98.3	95.6	99.1	98.3	99.1	F	1
NO _x (g per GJ fuel)	78	62	35	21	35	70	18	35	F	1
CH ₄ (g per GJ fuel)	0	0	0	0	0	0	0	0	F	1
N ₂ O (g per GJ fuel)	1	1	1	1	1	3	0	1	F	1
Particles (g per GJ fuel)	2.0	0.3	0.3	0.3	0.1	2.0	0.1	1.0	F	1
Financial data										
Nominal investment (M€/MWe)	3.2	3.1	3.1	2.8	2.6	3.7	2.2	3.8	J,K	1
- of which equipment	2.0	2.0	2.0	1.8	1.6	2.4	1.4	2.5	K	
- of which installation	1.1	1.1	1.1	1.0	1.0	1.3	0.8	1.3	K	
Fixed O&M (€/MWe/year)	130,800	127,100	123,300	110,800	110,600	110,700	85,800	104,200		
Variable O&M (€/MWh _e)	1.7	1.7	1.7	1.7	1.4	1.9	1.3	2.1		
Technology specific data										
Steam reheat	None	None	None	None	None	Yes	None	Yes		

Flue gas condensation	Yes	Yes	Yes	Yes	No	Yes	No	Yes		
Combustion air humidification	Yes	Yes	Yes	Yes	No	Yes	No	Yes		
Nominal investment (M€/MW fuel input)	0.95	0.93	0.91	0.83	0.77	1.12	0.66	1.13	J,K	1
- of which equipment	0.61	0.59	0.59	0.54	0.48	0.73	0.42	0.73	K	
- of which installation	0.34	0.33	0.32	0.29	0.29	0.40	0.24	0.40	K	
Fixed O&M (€/MW input/year)	39,500	38,300	36,800	33,100	32,100	45,000	25,200	42,700		
Variable O&M (€/MWh input)	0.51	0.51	0.51	0.51	0.43	0.59	0.38	0.64		
Fuel storage specific cost in excess of 2 days (M€/MW input/storage day)	0.003	0.003	0.003	0.003	0.003	0.003	0.002	0.003	K	

Notes:

- A The boiler in the plant is a suspension fired boiler producing steam to be used in a subsequent back pressure steam turbine. It is possible to pulverize wood pellets and use it for suspension firing but it has not been possible to find an appropriate reference.
- B Through a turbine by-pass all the produced steam energy is used for District Heat production.
- C Since wood pellets are relatively dry there is often only a minor efficiency advantage in using flue gas condensation. There is though an environmental advantage in having a scrubber in the flue gas stream. Direct condensation is assumed in all cases. Combustion air humidification is included except in lower range of 2020 and 2050. Direct condensation and combustion air humidification are included in all cases except in lower range of 2020 and 2050.
- D Secondary regulation normally relates to power production; for this type of plant it may not be of importance since load will normally follow heat consumption.
- E A limiting factor for the hot and cold start-up times is the size of the hot water tank (deaerator).
- F SNCR is assumed at NOx emissions at no less than 40 g/GJ. At lower NOx-levels it is chosen to include a tail-end SCR catalyst with slight adverse effect on electricity efficiency.
- G Warm start is starting with a glowing fuel layer on the grate and a warm deaerator.
- H The total efficiency is the sum of electricity efficiency and heat efficiency, applicable for "name plate" and "annual average", respectively. The "annual average" electricity efficiency is lower than "name plate" due to turbine outages and other incidents. The resulting lost power production is recovered as heat. This is why "annual average" heat efficiency is higher than "name plate" heat. Efficiencies refer to lower heating value. The parasitic electricity consumption has been subtracted in the listed electricity efficiencies.
- I The Cv value does not exist for plants with a back pressure turbine or an ORC turbine
- J Investment applies to a standard plant. There could be cost related to the actual project or site that adds to the total investment, e.g. additional fuel storage, facilities for chipping of logs, conditions for foundation and harbour facilities. Financial data and Technological specific data are essentially the total cost either divided by the electric net capacity, i.e. corresponding to the indicated name plate efficiencies, or by the thermal input. This is to indicate that new plants may not fully take advantage of the technical capabilities for full electricity production capacity. The two cost for electricity and thermal input, respectively, are not to be added up!
- K Note that investments include only two days fuel storage, and more may be optimal, depending on fuel supply opportunities and heat supply obligations, amongst other things. The additional investment is listed in the bottom row.

References

- 1 Rambøll Danmark, internal evaluation based on either existing projects, supplier offers, or pre-project studies.

Data sheets Wood Pellets CHP, large

Technology	Large Wood Pellets CHP, 800 MW feed									
	2015	2020	2030	2050	Uncertainty (2020)		Uncertainty (2050)		Note	Ref
Energy/technical data					Lower	Upper	Lower	Upper		
Generating capacity for one unit (MWe)	260.6	261.2	261.9	261.9	258.5	338.5	258.5	338.5	A	
Electricity efficiency, net (%), name plate	32.6	32.6	32.7	32.7	32	42	32	42	A, H	1
Electricity efficiency, net (%), annual average	30.9	31.0	31.1	31.1	29	40	29	40	A, H	1
Heat efficiency, net (%), name plate	63.8	63.9	63.8	63.8	43	64	43	64	B, H	1
Heat efficiency, net (%), annual average	65.4	65.5	65.4	65.4	47	66	47	66	B, H	1
Additional heat potential with heat pumps (% of thermal input)	1.7	1.7	1.7	1.7	2	12	2	12	C	1
Cb coefficient (40°C/80°C)	0.51	0.51	0.51	0.51	0.51	0.66	0.51	0.66		
Cv coefficient (40°C/80°C)	1	1	1	1	1	1	1	1	I	
Forced outage (%)	3	3	3	3	3	3	3	3		
Planned outage (weeks per year)	3.0	3.0	3.0	3.0	2.6	3.5	2.3	3.8		
Technical lifetime (years)	25	25	25	25	20	35	20	35		1
Construction time (years)	1	1	1	1	0.5	1.5	0.5	1.5		1
Space requirement (1000 m2/MWe)	0.1	0.1	0.1	0.1	0.1	0.1	0.0	0.1		
Primary regulation (% per 30 seconds)	2	2	2	2	2	2	2	2		
Secondary regulation (% per minute)	4	4	4	4	4	4	4	4	D	1
Minimum load (% of full load)	15	15	15	15	15	15	15	15		1
Warm start-up time (hours)	2	2	2	2	2	2	2	2	G	1
Cold start-up time (hours)	12	12	12	12	12	12	12	12	E	1
Environment										
SO ₂ (degree of desulphuring, %)	98.3	98.3	98.3	98.3	95.6	99.1	98.3	99.1		1
NO _x (g per GJ fuel)	20	21	18	11	11	26	7	18	C+F	
CH ₄ (g per GJ fuel)	0	0	0	0	0	0	0	0		
N ₂ O (g per GJ fuel)	1	1	1	1	1	3	0	1		
Particles (g per GJ fuel)	0.3	0.3	0.3	0.3	0.1	2.0	0.1	1.0		
Financial data										
Nominal investment (M€/MWe)	2.4	2.3	2.2	2.0	2.0	2.7	1.6	2.7	J,K	1
- of which equipment	1.3	1.3	1.2	1.1	1.1	1.5	0.9	1.5	K	
- of which installation	1.0	1.0	1.0	0.9	0.9	1.2	0.7	1.2	K	
Fixed O&M (€/MWe/year)	65,700	64,000	61,000	55,900	54,500	57,300	43,800	56,400		
Variable O&M (€/MWh_e)	1.6	1.6	1.6	1.6	1.3	1.8	1.2	1.9		
Technology specific data										
Steam reheat	None	None	None	None	None	Yes	None	Yes		
Flue gas condensation	Yes	Yes	Yes	Yes	No	Yes	No	Yes		
Combustion air humidification	Yes	Yes	Yes	Yes	No	Yes	No	Yes		

Nominal investment (M€/MW fuel input)	0.77	0.75	0.72	0.65	0.64	0.89	0.53	0.89	J,K	1
- of which equipment	0.43	0.42	0.40	0.36	0.35	0.49	0.29	0.50	K	
- of which installation	0.34	0.33	0.32	0.29	0.29	0.39	0.24	0.40	K	
Fixed O&M (€/MW input/year)	21,400	20,900	20,000	18,300	17,600	24,300	14,100	23,900		
Variable O&M (€/MWh input)	0.51	0.51	0.51	0.51	0.43	0.59	0.38	0.64		
Fuel storage specific cost in excess of 2 days (M€/MW_input/storage day)	0.003	0.002	0.002	0.002	0.002	0.003	0.002	0.003	K	

Notes:

- A The boiler in the plant is a suspension fired boiler producing steam to be used in a subsequent steam turbine. Currently, the steam turbine is expected to be a back pressure turbine with no re-heat. In some of the future scenarios it is assumed that the prices on electricity will allow for an increased electrical efficiency and subsequently re-heating of steam is introduced.
- B Through a turbine by-pass all the produced steam energy can be used for District Heat production.
- C Since wood pellets are relatively dry there is often only a minor efficiency advantage in using flue gas condensation. There is though an environmental advantage in having a scrubber in the flue gas stream. Direct condensation and combustion air humidification are included in all cases except in lower range of 2020 and 2050.
- D This is given by grid code (Energinet.dk)
- E A limiting factor for the hot and cold start-up times is the size of the hot water tank (deaerator).
- F This plant is equipped with an SCR catalyst for DeNOx and an electrostatic precipitator for catching dust/fly ash
- G Warm start is starting with the steam system being pressurized.
- H The total efficiency is the sum of electricity efficiency and heat efficiency, applicable for "name plate" and "annual average", respectively. The "annual average" electricity efficiency is lower than "name plate" due to turbine outages and other incidents. The resulting lost power production is recovered as heat. This is why "annual average" heat efficiency is higher than "name plate" heat. Efficiencies refer to lower heating value. The parasitic electricity consumption has been subtracted in the listed electricity efficiencies.
- I The Cv value may vary according to the optimization of the plant. A modest value representing a choice with current power/heat prices is shown but an approximate BAT value is given as 'UPPER'
- J Investment applies to a standard plant. There could be cost related to the actual project or site that adds to the total investment, e.g. additional fuel storage, facilities for chipping of logs, conditions for foundation and harbour facilities. Financial data and Technological specific data are essentially the total cost either divided by the electric net capacity, i.e. corresponding to the indicated name plate efficiencies, or by the thermal input. This is to indicate that new plants may not fully take advantage of the technical capabilities for full electricity production capacity. The two cost for electricity and thermal input, respectively, are not to be added up!
- K Note that investments include only two days fuel storage, and more may be optimal, depending on fuel supply opportunities and heat supply obligations, amongst other things. The additional investment is listed in the bottom row.

References

- 1 Rambøll Danmark, internal evaluation based on either existing projects, supplier offers, or pre-project studies.

Data sheets Straw CHP, small

Technology	Small Straw CHP, 20 MW feed								Note	Ref
	2015	2020	2030	2050	Uncertainty (2020)	Uncertainty (2050)	Lower	Upper		
Energy/technical data							Lower	Upper		
Generating capacity for one unit (MWe)	3.0	3.0	3.0	3.0	3.0	3.0	2.9	3.0	A	
Electricity efficiency, net (%), name plate	15.0	15.0	15.0	14.8	15	15	15	15	A, H	1
Electricity efficiency, net (%), annual average	14.2	14.2	14.3	14.1	13	14	13	14	A, H	1
Heat efficiency, net (%), name plate	84.2	84.2	84.2	84.4	72	85	71	85	B, H	1
Heat efficiency, net (%), annual average	85.0	85.0	84.9	85.1	74	85	73	86	B, H	1
Additional heat potential with heat pumps (% of thermal input)	1.7	1.7	1.7	1.7	2	13	2	14	C	1
Cb coefficient (40°C/80°C)	0.18	0.18	0.18	0.18	0.18	0.18	0.17	0.18		
Cv coefficient (40°C/80°C)	1	1	1	1	1	1	1	1	I	
Forced outage (%)	4	4	4	4	4	4	4	4		
Planned outage (weeks per year)	4.0	4.0	4.0	4.0	3.4	4.6	3.0	5.0		
Technical lifetime (years)	25	25	25	25	20	35	20	35		1
Construction time (years)	1	1	1	1	0.5	1.5	0.5	1.5		1
Space requirement (1000 m ² /MWe)	1.0	1.0	1.0	1.0	0.9	1.2	0.8	1.3		
Primary regulation (% per 30 seconds)	NA	NA	NA	NA	NA	NA	NA	NA		
Secondary regulation (% per minute)	10	10	10	10	10	10	10	10	D	1
Minimum load (% of full load)	50	50	50	50	50	50	50	50	D	1
Warm start-up time (hours)	0.25	0.25	0.25	0.25	0.25	0.25	0.25	0.25	G	1
Cold start-up time (hours)	0.5	0.5	0.5	0.5	0.5	0.5	0.5	0.5		1
Environment										
SO ₂ (degree of desulphuring, %)	95.5	96.4	99.1	99.8	90.9	99.8	95.5	99.9	F	1
NO _x (g per GJ fuel)	90	72	55	44	55	90	44	55	F	1
CH ₄ (g per GJ fuel)	16	11	8	4	4	16	2	16	F	1
N ₂ O (g per GJ fuel)	1	1	1	1	1	3	0	1	F	1
Particles (g per GJ fuel)	2.0	0.3	0.3	0.3	0.1	2.0	0.1	1.0	F	1
Financial data										
Nominal investment (M€/MWe)	7.0	6.8	6.4	6.2	5.9	8.0	5.2	8.4	E,J,K	1
- of which equipment	3.9	3.8	3.6	3.6	3.3	4.5	3.0	4.9	K	
- of which installation	3.0	3.0	2.8	2.6	2.6	3.5	2.1	3.6	K	
Fixed O&M (€/MWe/year)	323,800	318,200	306,800	298,000	276,300	365,100	235,200	378,700	J	
Variable O&M (€/MWh _e)	4.0	4.0	4.0	4.0	3.4	4.6	3.0	5.1	J	
Technology specific data										

Steam reheat	None	None	None	None	None	None	None	None		
Flue gas condensation	Yes	Yes	Yes	Yes	No	Yes	No	Yes		
Combustion air humidification	Yes	Yes	Yes	Yes	No	Yes	No	Yes		
Nominal investment (M€/MW fuel input)	1.05	1.02	0.97	0.92	0.89	1.20	0.77	1.25	E,J,K	1
- of which equipment	0.59	0.58	0.55	0.53	0.50	0.68	0.45	0.72	K	
- of which installation	0.46	0.44	0.42	0.38	0.39	0.52	0.32	0.53	K	
Fixed O&M (€/MW input/year)	48,600	47,700	46,100	44,100	40,800	55,300	34,200	56,500	J	
Variable O&M (€/MWh input)	0.60	0.60	0.60	0.60	0.51	0.69	0.45	0.75	J	
Fuel storage specific cost in excess of 2 days (M€/MW_input/storage day)	0.080	0.078	0.074	0.067	0.068	0.092	0.056	0.093	K	

Notes:

- A The plant is directly producing hot water for District Heating by burning fuel on a grate. The electric power is produced by an ORC module (Organic Rankine Cycle; Waste Heat Recovery - WHR). Refer for instance to the following link for further information about technology and suppliers: http://www.enova.no/upload_images/36AC689098414B05A7112FA2EE985BDA.pdf. This is low temperature and low efficiency electric power but at an affordable price.
- B Boilers up to 20 MW fuel input for hot water production are more or less standardized products with a high degree of fuel flexibility (type of biomass, humidity etc.)
- C Since straw is relatively dry there is often only a minor efficiency advantage in using flue gas condensation. There is though an environmental advantage in having a scrubber in the flue gas stream. Direct condensation and combustion air humidification are included in all cases except in lower range of 2020 and 2050.
- D Secondary regulation normally relates to power production; for this type of plant it may not be of importance. Though, the load control of the heat production is important and most units will perform better than the figure shown. Also, minimum load could be substantially lower.
- E Since electricity generation is only a secondary objective for minor heat producers, it may make more sense to relate the total investment only to the heat production capacity.
- F It is anticipated that for the smaller units the supplier has a SNCR solution to limit NOx emissions. SO2, CH4 and N2O emissions are low when combusting biomass.
- G Warm start is starting with a glowing fuel layer on the grate.
- H The total efficiency is the sum of electricity efficiency and heat efficiency, applicable for "name plate" and "annual average", respectively. The "annual average" electricity efficiency is lower than "name plate" due to turbine outages and other incidents. The resulting lost power production is recovered as heat. This is why "annual average" heat efficiency is higher than "name plate" heat. Efficiencies refer to lower heating value. The parasitic electricity consumption has been subtracted in the listed electricity efficiencies.
- I The Cv value does not exist for plants with a back pressure turbine or an ORC turbine
- J Investment applies to a standard plant. There could be cost related to the actual project or site that adds to the total investment, e.g. additional fuel storage, facilities for chipping of logs, conditions for foundation and harbour facilities. Financial data and Technological specific data are essentially the total cost either divided by the electric net capacity, i.e. corresponding to the indicated name plate efficiencies, or by the thermal input. This is to indicate that new plants may not fully take advantage of the technical capabilities for full electricity production capacity. The two cost for electricity and thermal input, respectively, are not to be added up!
- K Note that investments include only two days fuel storage, and more may be optimal, depending on fuel supply opportunities and heat supply obligations, amongst other things. The additional investment is listed in the bottom row.

References

- 1 Rambøll Danmark, internal evaluation based on either existing projects, supplier offers, or pre-project studies. NOTICE:

There are to our knowledge no references on ORC plants running on straw.

Data sheets Straw CHP, medium

Technology	Medium Straw CHP, 80 MW feed									
	2015	2020	2030	2050	Uncertainty (2020)		Uncertainty (2050)		Note	Ref
Energy/technical data					Lower	Upper	Lower	Upper		
Generating capacity for one unit (MWe)	24.8	24.4	24.5	24.5	23.5	25.1	24.1	25.2	A	
Electricity efficiency, net (%), name plate	31.0	30.5	30.6	30.6	29	31	30	32	A, H	1
Electricity efficiency, net (%), annual average	29.4	29.0	29.1	29.1	26	30	27	30	A, H	1
Heat efficiency, net (%), name plate	67.3	67.7	67.6	67.6	54	69	54	68	B, H	1
Heat efficiency, net (%), annual average	68.8	69.3	69.2	69.2	57	71	57	70	B, H	1
Additional heat potential with heat pumps (% of thermal input)	1.7	1.7	1.7	1.7	2	14	2	14	C	1
Cb coefficient (40°C/80°C)	0.46	0.45	0.45	0.45	0.43	0.46	0.45	0.47		
Cv coefficient (40°C/80°C)	1	1	1	1	1	1	1	1	I	
Forced outage (%)	4	4	4	4	4	4	4	4		
Planned outage (weeks per year)	4.0	4.0	4.0	4.0	3.4	4.6	3.0	5.0		
Technical lifetime (years)	25	25	25	25	20	35	20	35		1
Construction time (years)	2.5	2.5	2.5	2.5	2	3	1.5	3		1
Space requirement (1000 m ² /MWe)	0.3	0.3	0.3	0.3	0.2	0.3	0.2	0.4		
Primary regulation (% per 30 seconds)	NA	NA	NA	NA	NA	NA	NA	NA		
Secondary regulation (% per minute)	4	4	4	4	4	4	4	4	D	1
Minimum load (% of full load)	40	40	40	40	40	40	40	40		
Warm start-up time (hours)	2	2	2	2	2	2	2	2	E	1
Cold start-up time (hours)	8	8	8	8	8	8	8	8		1
Environment										
SO ₂ (degree of desulphuring, %)	95.5	96.4	99.1	99.8	90.9	99.8	95.5	99.9	F	1
NO _x (g per GJ fuel)	87	70	47	29	18	87	7	47	F	1
CH ₄ (g per GJ fuel)	0	0	0	0	0	0	0	0	F	1
N ₂ O (g per GJ fuel)	1	1	1	1	1	3	0	1	F	1
Particles (g per GJ fuel)	2.0	0.3	0.3	0.3	0.1	2.0	0.1	1.0	F	1
Financial data										
Nominal investment (M€/MWe)	3.7	3.8	3.6	3.3	3.1	4.5	2.6	4.5	J,K	1
- of which equipment	2.3	2.3	2.2	2.0	1.8	2.7	1.6	2.8	J,K	1
- of which installation	1.5	1.5	1.4	1.3	1.3	1.7	1.0	1.7	J,K	1
Fixed O&M (€/MWe/year)	150,400	149,900	141,100	126,300	129,400	168,700	98,000	158,100	J	1
Variable O&M (€/MWh _e)	1.9	2.0	2.0	2.0	1.7	2.3	1.5	2.4	J	1
Technology specific data										

Steam reheat	None	None	None	None	None	None	None	None		
Flue gas condensation	Yes	Yes	Yes	Yes	No	Yes	No	Yes		
Combustion air humidification	Yes	Yes	Yes	Yes	No	Yes	No	Yes		
Nominal investment (M€/MW fuel input)	1.16	1.16	1.10	1.00	0.95	1.36	0.81	1.37	J,K	1
- of which equipment	0.70	0.71	0.68	0.62	0.56	0.84	0.49	0.84	K	
- of which installation	0.46	0.45	0.42	0.38	0.39	0.53	0.32	0.53	K	
Fixed O&M (€/MW input/year)	46,600	45,800	43,200	38,700	38,000	53,000	29,600	49,900	J	
Variable O&M (€/MWh input)	0.60	0.60	0.60	0.60	0.51	0.69	0.45	0.75	J	
Fuel storage specific cost in excess of 2 days (M€/MW_input/storage day)	0.070	0.068	0.065	0.059	0.060	0.081	0.049	0.081	K	

Notes:

- A The boiler in the plant is grate fired producing steam to be used in a subsequent back pressure steam turbine. Though a grate is reasonable flexible with respect to combusting different fuels the fuel feed system will be dependent on the type of fuel used.
- B Through a turbine by-pass all the produced steam energy can be used for District Heat production.
- C Since straw is relatively dry there is often only a minor efficiency advantage in using flue gas condensation. There is though an environmental advantage in having a scrubber in the flue gas stream. Direct condensation and combustion air humidification are included in all cases except in lower range of 2020 and 2050.
- D Secondary regulation normally relates to power production; for this type of plant it may not be of importance since load will normally follow heat consumption.
- E A limiting factor for the hot and cold start-up times is the size of the hot water tank (deaerator).
- F For NOx-emissions no lower than 40 g/GJ SNCR is assumed. It is probably necessary to include a tail-end SCR catalyst to fulfill expected BREF requirements, particularly after year 2030. This has slight adverse effect on the electricity efficiency.
- G Warm start is starting with a glowing fuel layer on the grate and a warm deaerator.
- H The total efficiency is the sum of electricity efficiency and heat efficiency, applicable for "name plate" and "annual average", respectively. The "annual average" electricity efficiency is lower than "name plate" due to turbine outages and other incidents. The resulting lost power production is recovered as heat. This is why "annual average" heat efficiency is higher than "name plate" heat. Efficiencies refer to lower heating value. The parasitic electricity consumption has been subtracted in the listed electricity efficiencies.
- I The Cv value does not exist for plants with a back pressure turbine or an ORC turbine
- J Investment applies to a standard plant. There could be cost related to the actual project or site that adds to the total investment, e.g. additional fuel storage, facilities for chipping of logs, conditions for foundation and harbour facilities. Financial data and Technological specific data are essentially the total cost either divided by the electric net capacity, i.e. corresponding to the indicated name plate efficiencies, or by the thermal input. This is to indicate that new plants may not fully take advantage of the technical capabilities for full electricity production capacity. The two cost for electricity and thermal input, respectively, are not to be added up!
- K Note that investments include only two days fuel storage, and more may be optimal, depending on fuel supply opportunities and heat supply obligations, amongst other things. The additional investment is listed in the bottom row.

References

- 1 Rambøll Danmark, internal evaluation based on either existing projects, supplier offers, or pre-project studies.

Data sheets Straw CHP, large

Technology	Large Straw CHP, 132 MW feed									
	2015	2020	2030	2050	Uncertainty (2020)		Uncertainty (2050)		Note	Ref
Energy/technical data					Lower	Upper	Lower	Upper		
Generating capacity for one unit (MWe)	40.7	40.7	40.9	40.9	39.1	53.4	40.3	54.5	A	
Electricity efficiency, net (%), name plate	30.9	30.9	30.9	30.9	30	40	30	41	A, H	1
Electricity efficiency, net (%), annual average	29.3	29.3	29.4	29.4	27	38	27	39	A, H	1
Heat efficiency, net (%), name plate	67.9	67.9	67.8	67.8	45	69	44	68	B, H	1
Heat efficiency, net (%), annual average	69.5	69.5	69.4	69.4	48	71	47	70	B, H	1
Additional heat potential with heat pumps (% of thermal input)	1.7	1.7	1.7	1.7	2	14	2	14	C	1
Cb coefficient (40°C/80°C)	0.45	0.45	0.46	0.46	0.44	0.60	0.45	0.61		
Cv coefficient (40°C/80°C)	1	1	1	1	1	1	1	1	I	
Forced outage (%)	3	3	3	3	3	3	3	3		
Planned outage (weeks per year)	3	3	3	3	2.6	3.5	2.3	3.8		
Technical lifetime (years)	25	25	25	25	20	35	20	35		1
Construction time (years)	3	3	3	3	2.5	3.5	2	3.5		1
Space requirement (1000 m ² /MWe)	0.2	0.2	0.2	0.2	0.2	0.3	0.2	0.3		
Primary regulation (% per 30 seconds)	2	2	2	2	2	2	2	2		
Secondary regulation (% per minute)	4	4	4	4	4	4	4	4	D	1
Minimum load (% of full load)	40	40	40	40	40	40	40	40		
Warm start-up time (hours)	2	2	2	2	2	2	2	2	E	1
Cold start-up time (hours)	8	8	8	8	8	8	8	8		1
Environment										
SO ₂ (degree of desulphuring, %)	95.5	96.4	99.1	99.8	90.9	99.8	95.5	99.9	F	1
NO _x (g per GJ fuel)	84	67	36	18	18	84	7	36	F	1
CH ₄ (g per GJ fuel)	0	0	0	0	0	0	0	0	F	1
N ₂ O (g per GJ fuel)	1	1	1	1	1	3	0	1	F	1
Particles (g per GJ fuel)	0.3	0.3	0.3	0.3	0.1	2.0	0.1	1.0	F	1
Financial data										
Nominal investment (M€/MWe)	3.5	3.5	3.3	3.0	2.9	4.1	2.4	4.1	J,K	1
- of which equipment	2.2	2.1	2.0	1.8	1.8	2.5	1.5	2.5	J,K	
- of which installation	1.4	1.3	1.3	1.1	1.2	1.6	0.9	1.6	J,K	
Fixed O&M (€/MWe/year)	128,700	124,900	117,300	104,700	109,600	110,400	81,500	101,600	J	
Variable O&M (€/MWh _e)	1.9	1.9	1.9	1.9	1.7	2.2	1.5	2.4	J	
Technology specific data										
Steam reheat	None	None	None	None	None	Yes	None	Yes		

Flue gas condensation	Yes	Yes	Yes	Yes	No	Yes	No	Yes		
Combustion air humidification	Yes	Yes	Yes	Yes	No	Yes	No	Yes		
Nominal investment (M€/MW fuel input)	1.09	1.07	1.01	0.92	0.90	1.25	0.74	1.26	J,K	1
- of which equipment	0.67	0.66	0.63	0.57	0.55	0.77	0.45	0.78	K	
- of which installation	0.42	0.41	0.39	0.35	0.36	0.48	0.29	0.48	K	
Fixed O&M (€/MW input/year)	39,700	38,500	36,300	32,400	32,500	44,600	24,900	41,900	J	
Variable O&M (€/MWh input)	0.60	0.60	0.60	0.60	0.51	0.69	0.45	0.75	J	
Fuel storage specific cost in excess of 2 days (M€/MW input/storage day)	0.065	0.063	0.060	0.055	0.055	0.075	0.045	0.075	K	

Notes:

- A The boiler in the plant is grate fired producing steam to be used in a subsequent back pressure steam turbine. Though a grate is reasonable flexible with respect to combusting different fuels the fuel feed system will be dependent on the type of fuel used.
- B Through a turbine by-pass all the produced steam energy can be used for District Heat production.
- C Since straw is relatively dry there is often only a minor efficiency advantage in using flue gas condensation. There is though an environmental advantage in having a scrubber in the flue gas stream. Direct condensation and combustion air humidification are included in all cases except in lower range of 2020 and 2050.
- D Secondary regulation normally relates to power production; for this type of plant it may not be of importance since load will normally follow heat consumption.
- E A limiting factor for the hot and cold start-up times is the size of the hot water tank (deaerator).
- F For NOx-emissions no lower than 40 g/GJ SNCR is assumed. It is probably necessary to include a tail-end SCR catalyst to fulfill expected BREF requirements, particularly after year 2030.
This has slight adverse effect on the electricity efficiency.
- G Warm start is starting with a glowing fuel layer on the grate and a warm deaerator.
- H The total efficiency is the sum of electricity efficiency and heat efficiency, applicable for "name plate" and "annual average", respectively. The "annual average" electricity efficiency is lower than "name plate" due to turbine outages and other incidents. The resulting lost power production is recovered as heat. This is why "annual average" heat efficiency is higher than "name plate" heat. Efficiencies refer to lower heating value. The parasitic electricity consumption has been subtracted in the listed electricity efficiencies.
- I The Cv value does not exist for plants with a back pressure turbine or an ORC turbine
- J Investment applies to a standard plant. There could be cost related to the actual project or site that adds to the total investment, e.g. additional fuel storage, facilities for chipping of logs, conditions for foundation and harbour facilities. Financial data and Technological specific data are essentially the total cost either divided by the electric net capacity, i.e. corresponding to the indicated name plate efficiencies, or by the thermal input. This is to indicate that new plants may not fully take advantage of the technical capabilities for full electricity production capacity. The two cost for electricity and thermal input, respectively, are not to be added up!
- K Note that investments include only two days fuel storage, and more may be optimal, depending on fuel supply opportunities and heat supply obligations, amongst other things.
The additional investment is listed in the bottom row.

References

- 1 Rambøll Danmark, internal evaluation based on either existing projects, supplier offers, or pre-project studies.

Data sheets Wood Chips, HOP

Technology	Wood Chips, HOP, 6 MW feed									
	2015	2020	2030	2050	Uncertainty (2020)	Uncertainty (2050)	Note	Ref		
Energy/technical data					Lower	Upper	Lower	Upper		
Heat generation capacity for one unit (MW)	6.9	6.9	6.9	6.9	5.3	6.9	5.3	6.9	A	1
Total efficiency, net (%), name plate	114.9	114.9	114.9	114.9	89	115	89	115	B,C	1
Total efficiency, net (%), annual average	114.9	114.9	114.9	114.9	89	115	89	115	B,C	1
Additional heat potential with heat pumps (% of thermal input)	2.0	2.0	2.0	2.0	2	28	2	28	D	1
Auxiliary electricity consumption (% of heat gen)	2.3	2.3	2.3	2.3	2.2	2.5	1.8	2.5	C,K	
Forced outage (%)	3.0	3.0	3.0	3.0	3.0	3.0	3.0	3.0		
Planned outage (weeks per year)	2.0	2.0	2.0	2.0	1.7	2.3	1.5	2.5		
Technical lifetime (years)	25.0	25.0	25.0	25.0	20.0	35.0	20.0	35.0		1
Construction time (years)	1.0	1.0	1.0	1.0	0.5	1.5	0.5	1.5		1
Space requirement (1000 m ² /MWth heat output)	0.2	0.2	0.2	0.2	0.2	0.3	0.2	0.3		
Primary regulation (% per 30 seconds)	NA	NA	NA	NA	NA	NA	NA	NA		
Secondary regulation (% per minute)	10,0	10,0	10,0	10,0	10,0	10,0	10,0	10,0	E	1
Minimum load (% of full load)	20	20	20	20	20	20	20	20	E	1
Warm start-up time (hours)	0.3	0.3	0.3	0.3	0.3	0.3	0.3	0.3	H	1
Cold start-up time (hours)	0.5	0.5	0.5	0.5	0.5	0.5	0.5	0.5		1
Environment										
SO ₂ (degree of desulphuring, %)	98.0	98.0	98.0	98.0	89.9	99.0	98.0	99.0	G	1
NO _x (g per GJ fuel)	90	63	49	41	41	81	28	41	I	
CH ₄ (g per GJ fuel)	16	11	8	4	4	16	2	16	I	
N ₂ O (g per GJ fuel)	4	3	3	1	1	4	1	4	I	
Particles (g per GJ fuel)	2.0	0.3	0.3	0.3	0.1	2.0	0.1	1.0	I	
Financial data										
Nominal investment (M€/MWth - heat output)	0.70	0.68	0.65	0.59	0.60	0.81	0.49	0.81	F, L	
- of which equipment	0.41	0.40	0.38	0.34	0.35	0.47	0.28	0.47	F, L	
- of which installation	0.30	0.29	0.27	0.25	0.25	0.34	0.21	0.34	F, L	
Fixed O&M (€/MWth/year), heat output	32,800	32,200	31,200	29,300	35,800	37,300	29,300	37,600		
Variable O&M (€/MWh) heat output	1.0	1.0	1.0	1.0	0.8	1.1	0.7	1.2		
Technology specific data										
Flue gas condensation	Yes	Yes	Yes	Yes	No	Yes	No	Yes	J, L	
Combustion air humidification	Yes	Yes	Yes	Yes	No	Yes	No	Yes	J, L	
Nominal investment (M€/MW fuel input)	0.81	0.79	0.75	0.68	0.69	0.93	0.56	0.94	J, L	1
- of which equipment	0.47	0.46	0.43	0.39	0.40	0.54	0.32	0.54	L	
- of which installation	0.34	0.33	0.32	0.29	0.29	0.39	0.24	0.39	L	
Fixed O&M (€/MW input/year)	37,700	37,100	35,900	33,700	31,700	42,900	26,000	43,300		

Variable O&M (€/MWh input)	2.5	2.7	3.4	3.7	2.4	3.0	2.9	4.3		
- of which is electricity costs (€/MWh)	1.4	1.6	2.3	2.6	1.5	1.7	2.1	2.9	C	
- of which is other O&M costs (€/MWh)	1.1	1.1	1.1	1.1	0.9	1.3	0.8	1.4		
Fuel storage specific cost in excess of 2 days (M€/MW_input/storage day)	0.020	0.020	0.019	0.017	0.017	0.023	0.014	0.023	L	

Notes:

- A The plant is directly producing hot water for District Heating by burning fuel on a grate.
- B Boilers up to 20 MW fuel input for hot water production are more or less standardized products with a high degree of fuel flexibility (type of biomass, humidity etc.)
- C Efficiencies refer to lower heating value. The stated total efficiency does NOT consider auxiliary electricity consumption. It describes the total net amount of heat produced at the plant. This is contrary to CHP where the auxiliary electricity is subtracted from the production to yield the net electricity efficiency. Instead the cost of auxiliary electricity consumption is included in variable O&M and is calculated using the following electricity prices in €/MWh: 2015: 63, 2020: 69, 2030: 101, 2050: 117. These prices include production costs and transport tariffs, but not any taxes or subsidies for renewable energy.
- D There are plants of this type with up to 108 % efficiency using flue gas condensation with moist wood chips and close to 115 % efficiency with both flue gas condensation and absorption heat pumps activated. The colder the return temperature of the district heating, the higher the total efficiency at direct condensation. Direct condensation and combustion air humidification are included in all cases except in lower range of 2020 and 2050.
- E Load control of the heat production is important and units of this size can make rapid load variations. Similarly, the minimum load is quite low
- F Reference to heat output because of the lack of electricity production
- G assuming content of sulphur in fuel of 20 g/GJ
- H Warm start is starting with a glowing fuel layer on the grate.
- I Estimated from: Nielsen, M., Nielsen, O.-K., Plejdrup, M. & Hjelgaard, K., 2010: Danish Emission Inventories for Stationary Combustion Plants. Inventories until 2008. National Environmental Research Institute, Aarhus University, Denmark. 236 pp. – NERI Technical Report No. 795. <http://www.dmu.dk/Pub/FR795.pdf>.
- J The nominal investment is in the range 0.6 to 1.1 M€/Mwth
- K Result of model calculation, there are reports of DH plants operating at lower power consumption, down to 1% of heat generation.
- L Note that investments include only two days fuel storage, and more may be optimal, depending on fuel supply opportunities and heat supply obligations, amongst other things. The additional investment is listed in the bottom row.

References

- 1 Rambøll Danmark, internal evaluation based on either existing projects, supplier offers, or pre-project studies.

Data sheets Wood Pellets, HOP

Technology	Wood Pellets, HOP, 6 MW feed								Note	Ref
	2015	2020	2030	2050	Uncertainty (2020)		Uncertainty (2050)			
Energy/technical data	Lower		Upper		Lower		Upper			
Heat generation capacity for one unit (MW)	6.0	6.0	6.0	6.0	5.4	6.0	5.4	6.0	A	1
Total efficiency, net (%), name plate	100.1	100.1	100.1	100.1	90	100	90	100	B,C	1
Total efficiency, net (%), annual average	100.1	100.1	100.1	100.1	90	100	90	100	B,C	1
Additional heat potential with heat pumps (% of thermal input)	1.7	1.7	1.7	1.7	2	12	2	12	D	1
Auxiliary electricity consumption (% of heat gen)	2.1	2.1	2.1	2.1	1.8	2.3	1.4	2.3	C,K	
Forced outage (%)	3.0	3.0	3.0	3.0	3.0	3.0	3.0	3.0		
Planned outage (weeks per year)	3.0	3.0	3.0	3.0	2.6	3.5	2.3	3.8		
Technical lifetime (years)	25.0	25.0	25.0	25.0	20.0	35.0	20.0	35.0		1
Construction time (years)	1.0	1.0	1.0	1.0	0.5	1.5	0.5	1.5		1
Space requirement (1000 m ² /MWth heat output)	0.2	0.2	0.2	0.2	0.1	0.2	0.1	0.2		
Primary regulation (% per 30 seconds)	NA	NA	NA	NA	NA	NA	NA	NA		
Secondary regulation (% per minute)	10.0	10.0	10.0	10.0	10.0	10.0	10.0	10.0	E	1
Minimum load (% of full load)	40.0	40.0	40.0	40.0	40.0	40.0	40.0	40.0	E	1
Warm start-up time (hours)	0.3	0.3	0.3	0.3	0.3	0.3	0.3	0.3	H	1
Cold start-up time (hours)	0.5	0.5	0.5	0.5	0.5	0.5	0.5	0.5		1
Environment										
SO ₂ (degree of desulphuring, %)	98.3	98.3	98.3	98.3	91.3	99.1	98.3	99.1	G	1
NO _x (g per GJ fuel)	90	54	42	35	35	70	25	35	G	1
CH ₄ (g per GJ fuel)	0	0	0	0	0	0	0	0	G	1
N ₂ O (g per GJ fuel)	1	1	1	1	1	3	0	1	G	1
Particles (g per GJ fuel)	2.0	0.3	0.3	0.3	0.1	2.0	0.1	1.0	G	1
Financial data										
Nominal investment (M€/MWth - heat output)	0.74	0.72	0.69	0.67	0.63	0.90	0.57	0.91	F, L	
- of which equipment	0.45	0.44	0.42	0.43	0.38	0.57	0.36	0.57	F, L	
- of which installation	0.29	0.28	0.27	0.24	0.25	0.33	0.20	0.34	F, L	
Fixed O&M (€/MWth/year), heat output	34,000	33,000	31,300	29,200	31,700	39,200	25,600	37,400	F	
Variable O&M (€/MWh) heat output	0.5	0.5	0.5	0.5	0.4	0.6	0.4	0.6	F	
Technology specific data										
Flue gas condensation	Yes	Yes	Yes	Yes	No	Yes	No	Yes	J	
Combustion air humidification	Yes	Yes	Yes	Yes	No	Yes	No	Yes	J	
Nominal investment (M€/MW fuel input)	0.74	0.72	0.69	0.67	0.63	0.90	0.57	0.91	J, L	1
- of which equipment	0.45	0.44	0.42	0.43	0.38	0.57	0.36	0.57	L	
- of which installation	0.29	0.28	0.27	0.24	0.25	0.34	0.20	0.34	L	

Fixed O&M (€/MW input/year)	34,000	33,100	31,300	29,300	28,300	39,300	22,900	37,500		
Variable O&M (€/MWh input)	1.8	1.9	2.6	2.9	1.6	2.2	2.1	3.3		
- of which is electricity costs (€/MWh)	1.3	1.4	2.1	2.4	1.2	1.6	1.7	2.7	C	
- of which is other O&M costs (€/MWh)	0,5	0,5	0,5	0,5	0,4	0,6	0,4	0,6		
Fuel storage specific cost in excess of 2 days (M€/MW_input/storage day)	0,004	0,004	0,004	0,003	0,003	0,005	0,003	0,005	L	

Notes:

- A The plant is directly producing hot water for District Heating by burning fuel on a grate.
- B Boilers up to 20 MW fuel input for hot water production are more or less standardized products with a high degree of fuel flexibility (type of biomass, humidity etc.)
- C The stated total efficiency does NOT consider auxiliary electricity consumption. It describes the total net amount of heat produced at the plant. This is contrary to CHP where the auxiliary electricity is subtracted from the production to yield the net electricity efficiency. Instead the cost of auxiliary electricity consumption is included in variable O&M and is calculated using the following electricity prices in €/MWh: 2015: 63, 2020: 69, 2030: 101, 2050: 117. These prices include production costs and transport tariffs, but not any taxes or subsidies for renewable energy.
- D There are plants of this type with up to 108 % efficiency using flue gas condensation with moist wood chips and close to 115 % efficiency with both flue gas condensation and absorption heat pumps activated. The colder the return temperature of the district heating, the higher the total efficiency at direct condensation. Direct condensation and combustion air humidification are included in all cases except in lower range of 2020 and 2050.
- E Load control of the heat production is important and units of this size can make rapid load variations. Similarly, the minimum load is quite low
- F Reference to heat output because of the lack of electricity production
- G Emissions shall comply with Danish EPA guideline, Luftvejledning. It is anticipated that for the smaller units the supplier has an SNCR solution to reduce NOx emissions sufficiently.
- I Warm start is starting with a glowing fuel layer on the grate.
- J The nominal investment is in the range 0.6 to 1.1 M€/Mwh
- K Result of model calculation, there are reports of DH plants operating at lower power consumption
- L Note that investments include only two days fuel storage, and more may be optimal, depending on fuel supply opportunities and heat supply obligations, amongst other things. The additional investment is listed in the bottom row.

References

- 1 Rambøll Danmark, internal evaluation based on either existing projects, supplier offers, or pre-project studies.

Data sheets Straw, HOP

Technology	Straw, HOP, 6 MW feed									
	2015	2020	2030	2050	Uncertainty (2020)		Uncertainty (2050)		Note	Ref
Energy/technical data					Lower	Upper	Lower	Upper		
Heat generation capacity for one unit (MW)	6.1	6.1	6.1	6.1	5.4	6.1	5.4	6.1	A	1
Total efficiency, net (%), name plate	102.1	102.1	102.1	102.1	89	102	89	102	B,C	1
Total efficiency, net (%), annual average	102.1	102.1	102.1	3.0	89	102	89	102	B,C	1
Additional heat potential with heat pumps (% of thermal input)	1.7	1.7	1.7	1.7	2	14	2	14	D	1
Auxiliary electricity consumption (% of heat gen)	2.1	2.1	2.1	2.1	1.9	2.3	1.5	2.3	C,J	
Forced outage (%)	4.0	4.0	4.0	4.0	4.0	4.0	4.0	4.0		
Planned outage (weeks per year)	4.0	4.0	4.0	4.0	3.4	4.6	3.0	5.0		
Technical lifetime (years)	25.0	25.0	25.0	25.0	20.0	35.0	20.0	35.0		1
Construction time (years)	1.0	1.0	1.0	1.0	0.5	1.5	0.5	1.5		1
Space requirement (1000 m2/MWe)	0.2	0.2	0.2	0.2	0.2	0.3	0.2	0.3		
Primary regulation (% per 30 seconds)	NA	NA	NA	NA	NA	NA	NA	NA		
Secondary regulation (% per minute)	10.0	10.0	10.0	10.0	10.0	10.0	10.0	10.0	E	1
Minimum load (% of full load)	50.0	50.0	50.0	50.0	50.0	50.0	50.0	50.0	E	1
Warm start-up time (hours)	0.3	0.3	0.3	0.3	0.3	0.3	0.3	0.3	H	1
Cold start-up time (hours)	0.5	0.5	0.5	0.5	0.5	0.5	0.5	0.5		1
Environment										
SO ₂ (degree of desulphuring, %)	95.5	96.4	99.1	99.8	90.9	99.8	95.5	99.9	G	1
NO _x (g per GJ fuel)	90	72	73	73	36	90	18	73	G	1
CH ₄ (g per GJ fuel)	16	11	8	4	4	16	2	16	G	1
N ₂ O (g per GJ fuel)	4	3	2	1	1	4	1	4	G	1
Particles (g per GJ fuel)	2.0	0.3	0.3	0.3	0.1	2.0	0.1	1.0	G	1
Financial data										
Nominal investment (M€/MWth - heat output)	0.91	0.89	0.84	0.76	0.77	1.09	0.63	1.10	F,K	
- of which equipment	0.44	0.43	0.41	0.37	0.37	0.56	0.31	0.56	F,K	
- of which installation	0.47	0.46	0.43	0.39	0.40	0.54	0.32	0.54	F,K	
Fixed O&M (€/MWth/year), heat output	52,900	51,300	48,400	43,300	50,200	60,200	38,000	56,200	F	
Variable O&M (€/MWh) heat output	0.6	0.6	0.6	0.6	0.5	0.7	0.4	0.7	F	
Technology specific data										
Flue gas condensation	Yes	Yes	Yes	Yes	No	Yes	No	Yes		
Combustion air humidification	Yes	Yes	Yes	Yes	No	Yes	No	Yes		
Nominal investment (M€/MW fuel input)	0.93	0.90	0.86	0.78	0.79	1.12	0.64	1.12	I,K	1
- of which equipment	0.45	0.44	0.42	0.38	0.38	0.57	0.31	0.57	K	

- of which installation	0.48	0.46	0.44	0.40	0.41	0.55	0.33	0.55	K	
Fixed O&M (€/MW input/year)	54,000	52,400	49,400	44,200	44,800	61,600	33,900	57,500		
Variable O&M (€/MWh input)	1.9	2.1	2.7	3.1	1.8	2.3	2.2	3.5		
- of which is electricity costs (€/MWh)	1.3	1.5	2.1	2.5	1.3	1.6	1.7	2.7	C	
- of which is other O&M costs (€/MWh)	0.6	0.6	0.6	0.6	0.5	0.7	0.5	0.8		
Fuel storage specific cost in excess of 2 days (M€/MW_input/storage day)	0.080	0.078	0.074	0.067	0.068	0.092	0.056	0.093	K	

Notes:

- A The plant is directly producing hot water for District Heating by burning fuel on a grate.
- B Boilers up to 20 MW fuel input for hot water production are more or less standardized products with a high degree of fuel flexibility (type of biomass, humidity etc.)
- C The stated total efficiency does NOT consider auxiliary electricity consumption. It describes the total net amount of heat produced at the plant. This is contrary to CHP where the auxiliary electricity is subtracted from the production to yield the net electricity efficiency. Instead the cost of auxiliary electricity consumption is included in variable O&M and is calculated using the following electricity prices in €/MWh: 2015: 63, 2020: 69, 2030: 101, 2050: 117. These prices include production costs and transport tariffs, but not any taxes or subsidies for renewable energy.
- D There are plants of this type with up to 108 % efficiency using flue gas condensation with moist wood chips and close to 115 % efficiency with both flue gas condensation and absorption heat pumps activated. The colder the return temperature of the district heating, the higher the total efficiency at direct condensation. Direct condensation and combustion air humidification are included in all cases except in lower range of 2020 and 2050.
- E Load control of the heat production is important and units of this size can make rapid load variations. Similarly, the minimum load is quite low
- F Reference to heat output because of the lack of electricity production
- G Emissions shall comply with Danish EPA guideline, Luftvejledning. It is anticipated that for the smaller units the supplier has an SNCR solution to reduce NOx emissions sufficiently.
- I Warm start is starting with a glowing fuel layer on the grate.
- J The nominal investment is in the range 0.6 to 1.1 M€/Mwth
- K Result of model calculation, there are reports of DH plants operating at lower power consumption
- L Note that investments include only two days fuel storage, and more may be optimal, depending on fuel supply opportunities and heat supply obligations, amongst other things. The additional investment is listed in the bottom row.

References

- 1 Rambøll Danmark, internal evaluation based on either existing projects, supplier offers, or pre-project studies.

10 Stirling engines, gasified biomass

This chapter has been moved here from the previous Technology Data Catalogue for Electricity and district heating production from May 2012. Therefore, the text and data sheets do not follow the same guidelines as the remainder of the catalogue.

Brief technology description

A Stirling engine is driven by temperature differences created by external heating and cooling sources. One part of the engine is permanently hot, while another part of the engine is permanently cold.

The engine is filled with a working gas, typically Hydrogen or Helium, and pressurized. This working gas is moved between the hot and the cold side of the engine by a mechanical system comprising of a displacement piston coupled to a working piston. When the working gas is heated in the hot side of the engine, it expands and pushes the working piston. When the working piston moves, the displacement piston then forces the working gas to the cold side of the engine, where it cools and contracts.

In the biomass-gasifier solution developed by the company Stirling DK, the engine is Helium-filled, heated by biomass combustion flue gasses, and cooled by cooling water.

Specifically, a solid biomass fuel is converted into producer gas, which is led to one or more combustion chambers, each coupled to a Stirling engine. The gas is ignited in the combustion chamber(s), and the flue gases are heating the Stirling engine(s), which is driving an electricity generator.

For a more detailed description of the gasifier process, please refer to technology no. 84.

Input

Wood chips, industrial wood residues, demolition wood and energy crops can be used. Also, it is expected that more exotic fuel types, such as coconut shells and olive stones, can be used. Requirements to moisture content and size of the fuel are depending on the design of the gasifier.

The Stirling engines can also be fuelled by natural gas and mineral oil.

Output

Electricity and heat.

The electricity efficiency, when using wood chips, is around 18%.

Typical capacities

The electric output of one Stirling engine is 35 kW. For plants with several engines, one common gasifier is used.

Regulation ability

The heat load can be changed from 10 to 100 % and vice versa within a few minutes. The electrical output can not be regulated quickly.

Advantages/disadvantages

The main advantage of the Stirling engine is that it can generate power using residues from forestry and agriculture, which typically have a very low economic value. In addition, emission levels are very low. Finally, the service requirement of a Stirling engine is very low compared to otto- and diesel-engines.

The main disadvantage is a relatively high capital cost compared to otto- and diesel-engines.

Stirling engines are therefore ideally used for base load generation with many annual operating hours, preferable 6-8,000 hours/year.

Environment

A highly controlled gasification process together with the continuous combustion process secure much lower air emissions than otto- and diesel-engines.

Research, development and demonstration

The Danish Stirling engine updraft-gasifier technology is presently being supported in two projects:

- A multi-unit system with two engines and a wood gas boiler (for heat only) on one common updraft gasifier, is being developed, supported by PSO-means. Also a new combustion technology, high efficiency, is being developed under this program.
- A containerized plant has been built, supported by EUDP-means. In order to demonstrate fuel flexibility, the plant will be tested with 8 different fuel types. Also, an off-grid solution will be developed.

Examples of best available technology

Examples of plants in Denmark:

- In Svanholm, an 800 kJ/s updraft counter-current fixed bed gasifier was installed in 2009. The gasifier utilises wood chips and is coupled to two 35 kW Stirling engines and a 400 kJ/s wood gas boiler.
- In both Copenhagen and Lyngby, a 200 kJ/s updraft counter-current fixed bed gasifier was installed in 2009. Each gasifier utilises wood chips and is coupled to one 35 kW Stirling engine

References

1. Biomasse kraftvarme udviklingskortlægning – Resume-rapport. Eltra. Elkraft System. Danish Energy Agency, 2003
2. Strategi for forskning, udvikling og demonstration af biomaseteknologi til el- og kraftvarmeproduktion i Danmark, Danish Energy Agency, Elkraft System og Eltra, 2003.
3. Stirling DK, December 2009.

Data sheets

Technology	Stirling engine, fired by gasified biomass					
	2015	2020	2030	2050	Note	Ref
Energy/technical data						
Generating capacity electric, (kW)	37	40				1
Generating capacity, heat, (kJ/s)	120	120				1
Electrical efficiency (%)	20	22			A	1
Time for warm-up (hours)	1	1				1
Forces outage (%)	4	3				1
Planned outage (weeks per year)	3	2				1
Technical lifetime (years)	15	15				1
Construction time (years)	0	0.3			B	1
Environment						
SO ₂ (degree of desulphuring, %)	0	0				1
NO _x (ppm)	130	100				1
CH ₄ (ppm)	0	0				1
N ₂ O (ppm)	0	0				1
Financial data						
Specific investment costs (M€/MW)	5.0	3.8			C+E	1
Fixed O&M (€/MW/year)	32000	32000			D+E	1
Variable O&M (€/MWh)	26	21			D+E	1

References:

- 1 Stirling DK, December 2009

Notes:

- A The efficiency of the gasifier is 97%, while the total efficiency for the whole system is 90% (2020).
- B The plants may be delivered as pre-assembled container solutions reducing construction times on site to a couple of weeks.
- C Complete plant, including gasifier, combustion chambers, engines, control system, piping, and instrumentation.
- D O&M for the Stirling engine itself is (2010) around 16 €/MWh, while the remaining O&M costs are for biomass feeding, gasification, heat exchangers etc.
- E Cost data are the same as in the 2010 catalogue, however inflated from price level 2008 to 2011 by multiplying with a general inflation factor 1.053

11 Solid oxide fuel cell CHP (natural gas/biogas)

Contact information:

Danish Energy Agency: Rikke Næraa, rin@ens.dk

Energinet: Rune Grandal, rdg@energinet.dk

Author: DTU Energy, Jonathan Hallinder, Eva Ravn Nielsen in cooperation with Ea Energy Analyses.

Adapted from “Technology Data for Hydrogen Technologies” (2016), prepared as part of the project “Analysis for Commercialization of Hydrogen Technologies” under the Danish Energy Technology Development and Demonstration Programme (EUDP).

Review: DGC

Publication date

March 2018

Amendments after publication date

Date	Ref.	Description
-	-	-
-	-	-

Qualitative description

Brief technology description

Solid oxide fuel cell based combined heat and power systems (SOFC-CHP), or SOFC Distributed Generation, typically use natural gas or biogas as fuel and, therefore, they can simply be connected to the gas grid like conventional natural gas boilers. Alternatively, SOFC-CHP can also utilise hydrogen and syngas or propane/LPG or diesel as fuel. A CHP system produces both electricity and heat. The electricity can be used directly at the production site, be fed into the electrical grid or in remote areas be the sole source of electricity substituting a

diesel generator. The produced heat can either be used directly at the site or delivered to a district heating

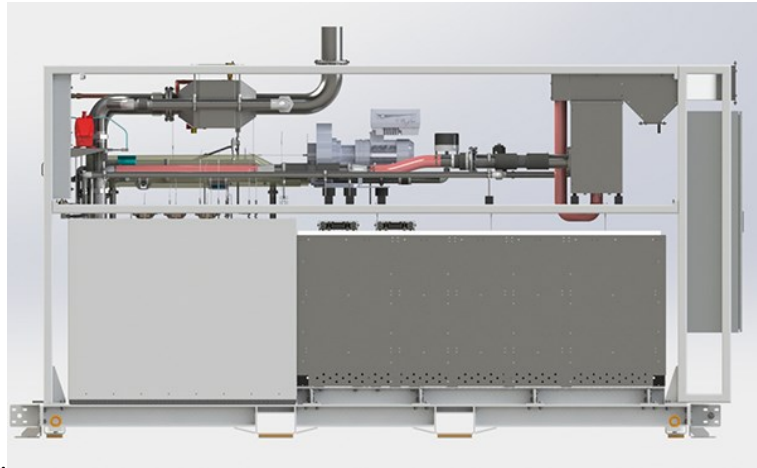

grid.

Figure 1: SOFC unit from Sunfire for combined heat and power for commercial use [9].

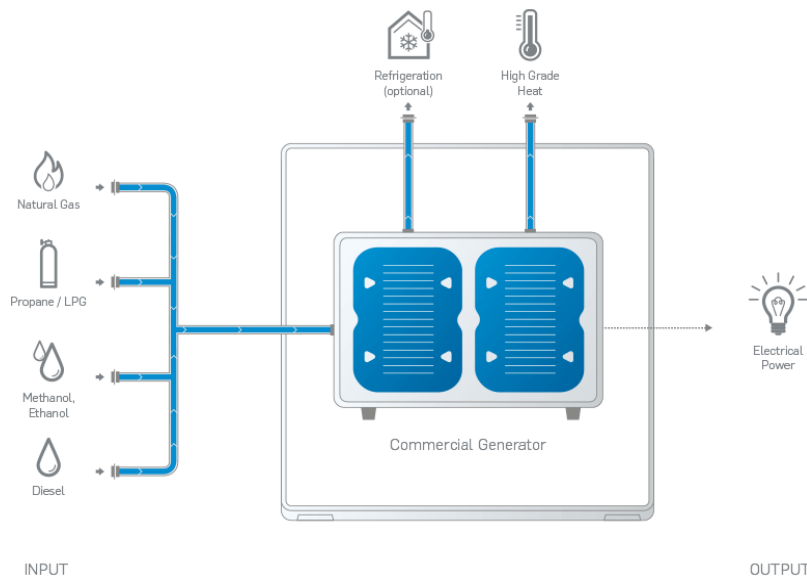

Figure 2: Schematic illustration of an SOFC unit for combined heat and power for commercial use from Sunfire illustrating the flexibility in input fuels [9].



Figure 3: C50 module from Convion with 50 kW. Systems up to 300 kW are being developed [10].

Input

Natural gas or biogas.

Output

Electricity and heat.

The product can be designed to meet the requirements for district heating, but the present early products focus mainly on providing power. The fuel cell is operated at very high temperatures (600-700 degree Celsius) allowing the surplus heat to be used for high temperature industrial processes.

In the data sheet CHP systems are only considered from 2020.

With minor adaption to the feeding system a SOFC unit may also be fuelled with ethanol and ammonia.

Typical capacities

Today, no large scale SOFC-CHP systems are available at the market, but they can be aligned with the sizes of pure distributed generation units used for baseload and backup, e.g. SOFC systems like systems provided by Bloom energy. These systems are today available in modules up to 250 kW_e power, but as mentioned above these modules can be clustered to achieve larger plants [1].

SOFC-CHP systems are also available in very small scale including mCHP plants for households.

Space requirement

23 m²/MW_e (based on one Energy Server 5 + five UPM-571 modules from Bloom Energy [11] of 1.25 MW in total).

Regulation ability

The fuel cell CHP system can modulate, but the high temperature of reformer and fuel cell requires the hot part to be kept at a high temperature to facilitate modulating.

SOFC systems can be designed to regulate below 30% of nominal load without any significant loss of efficiency. The response time can be very short (a few seconds) when the system is in standby mode.

Advantages/disadvantages

The main advantages include:

- SOFC-CHP units produce both electricity and heat in cogeneration with higher electrical efficiency than for other cogeneration technologies in the same power range fuelled by natural gas or biogas.
- Decentralised cogeneration of electricity and heat minimises grid losses and the need for additional infrastructure investments.
- The required gas quality is less strict compared to gas engines. SOFC-CHP units are more flexible in relation to fuels and can run on different types of gasses (methane, syngas, hydrogen and biogas)

without them being upgraded to SNG. This means that natural gas fuelled SOFC-CHP can be operated from the natural gas grid even if the natural gas is exchanged with synthetic natural gas (SNG).

- Unlike conventional power plants, the produced CO₂ is not mixed with oxygen and nitrogen from the atmosphere. This makes it easier and more cost-efficient to capture and store the produced CO₂.

The main disadvantages include:

- Currently, lifetime of the stacks is relatively short. Some manufacturers do however report a stack life-time of about 6 years when operating in baseload. Several replacements of stacks may be relevant during the lifetime of the plant.
- Long start-up times from a cold start.

Environment

The emissions from natural gas fuelled SOFCs are relatively low compared to electricity produced at central power plants. Because there is no combustion of fuels (it is a chemical reaction), the emission of for example NO_x is lower than what is emitted from a traditional power plant. If biogas (fossil free gas) is used the operation of the plant can be considered carbon neutral. Today, the most common used material for the anode in SOFCs consist of nickel mixed with yttria-stabilized zirconia (YSZ). In the production and end of life disposal, the use of nickel is a concern as it is carcinogenic.

Research and development perspectives

SOFC-CHP units are still under development. The development is concentrated on reducing the costs of the units, increasing the lifetime and increasing the reliability.

In a later phase, the research and development activities may be concentrated on how to use the units in a smart grid context so that fuel cells can optimize their operation according to dynamic electricity prices.

BloomEnergy from USA is developing and has commercialized fuel cell systems for base load / backup power, meaning systems where only the power is used and the heat considered waste. Thus, they are not developing CHP systems they are the only player on the commercial market with SOFC systems in the adequate power range. A few other companies are getting close to realizing their first commercial SOFC CHP units, for example Mitsubishi ([1], [2]), Sunfire and Convion.



Figure 4: BloomEnergy SOFC system. The dashed region corresponds to the 250 kW_e unit [1].

Examples of market standard technology

Large scale SOFC units for power supply can be purchased from BloomEnergy, Convion and Sunfire. The first two focus on providing power, whereas the latter focus on a reversible system that can alternate between providing power and providing hydrogen (SOFC/SOEC).

No CHP systems in the relevant power range are available; therefore, the Bloom Energy ES-5710 unit has been selected as the reference system. This system is a power producing system and does not utilise the produced heat.

Prediction of performance and costs

The technology is classified between Category 1: Research and development and Category 2: Pioneer phase, demonstration.

The typical generation capacity is expected to increase from around 2.5 MW in 2020 to around 20 MW in 2050, while the electrical efficiency is expected to increase to 60%. The investment costs of the SOFC CHP are projected to decrease from 3.3 M€₂₀₁₅/MW in 2020 to 0.6 M€₂₀₁₅/MW in 2050. The projection is based on Cost Study for Manufacturing of Solid Oxide Fuel Cell Power Systems, 2013, Pacific Northwest National Laboratory prepared for the U.S. Department of Energy [13]. In 2020, an annual production of 50 units is assumed, in 2030 a yearly production of 250 units is assumed, and in 2050, a production of 4000 units per year is assumed.

For comparison the Technology Roadmap - Hydrogen and Fuel Cells, 2015, International Energy Agency [12], estimates a cost reduction to around 1.8 M€₂₀₁₅/MW between 2025 and 2035.

Uncertainty

The uncertainty related to the cost projection is very significant and is affected by challenges such as lifetime improvements, improved operational flexibility and reduction of investment costs as a result of mass production.

Economy of scale

-

Additional remarks

No additional remarks.

Data sheets

Technology	SOFC - CHP Natural Gas / Biogas									
	2015	2020	2030	2050	Uncertainty (2020)		Uncertainty (2050)		Note	Reference
Energy/technical data					Lower	Upper	Lower	Upper		
Generating capacity for one unit (MWe)	0.25	2.5	10	20					A	3; *, *, *
Electricity efficiency (condensation mode for extraction plants), net (%), name plate	56	58	60	60						
Electricity efficiency (condensation mode for extraction plants), net (%), annual average	56	58	60	60	52	60	56	62	B	3; *, *, *
Cb coefficient (50°C/100°C)	-	1.67	1.61	1.61					C, L	-, *, *, *
Cv coefficient (50°C/100°C)	-	-	-	-						
Forced outage (%)										
Planned outage (weeks per year)										
Technical lifetime (years)	15	20	20	20					D	6; 6; *, *
Construction time (years)	1	1	1	1						
Regulation ability										
Primary regulation (% per 30 seconds)										
Secondary regulation (% per minute)										
Minimum load (% of full load)	70	70	70	70						
Warm start-up time (hours)	0.025	0.025	0.025	0.025					E	
Cold start-up time (hours)	25	25	25	25					E	*, *, *, *
Environment										
SO ₂ (degree of desulphuring, %)	100	100	100	100						3
NO _x (g per GJ fuel)	1.3	1.4	1.5	1.6						3
CH ₄ (g per GJ fuel)	1.25	1.25	1.25	1.25					F	7
N ₂ O (g per GJ fuel)	NA	NA	NA	NA					F	*
Financial data										
Nominal investment (M€/MW)	8.3	3.3	2	0.8	2.7	5.8	0.4	1.3	G, H, I, J	8, 13
- of which equipment	6.64	2.3	1.2	0.464					G	
- of which installation	1.66	1.0	0.8	0.336					G	
Fixed O&M (€/MW/year)	415,000	165,000	100,000	40,000	135,000	290,000	20,000	65,000	K	8
Variable O&M (€/MWh)	-									
Startup cost (€/MW/startup)	-									

Notes:

- A Installed systems consist of modules of app. 200 kW_{el} power, these modules can be clustered into larger units. Today, often up to app. 2 MW_{el} power and upwards. [5,8]
- B The electrical efficiency (based on the lower heating value, LHV) of Bloom Energy's systems decreases from an initial value of 60 % to 52 % by the end-of life for the stacks. This gives an average electrical efficiency of 56 % for the life-time of a stack. Uncertainties represent the aforementioned interval.
- C No CHP-systems in this power range are available, therefore, Bloom Energy ES-5710 unit has been chosen as the reference system. This system is a power producing system and does not take the produced heat into account. . The produced heat can be used as thermal storage, hot water production, heating or for feed in to the distributed heating system. High total efficiencies can be expected as the systems are compact and with a small surface area, leading to low heat losses and thereby high total system efficiency. Thus it is not unrealistic to assume a total efficiency above 90 % (thermal efficiency > 35 %) for this type of system.
- D Values correspond to the durability for the whole plant; the stack may be exchanged several times during the life time of the plant.
- E Start up from outdoor temperature or room temperature takes rather long time, this is mainly due to the large amount of ceramic material which require slow heating ramps. If the system is at operating temperature the stack can be started up quickly, assuming that gases are supplied and help systems are active. Also shut down can be performed quickly, not counting in the time required to cool the system.
- F Value for SOFC microCHP systems used here, since SOFC-CHP's has the same operating principle.
- G A bloom unit costs approximately 6600 euro per kW_{el}. To this must the installation costs be added, which of course depends on the location and the size of the unit. Additional costs are also to cover for necessary modifications of the system, e.g. implementation of hot water storage and subsystems for exporting the heat from the unit to surrounding buildings or distributed heating grid.
- H Start up from outdoor temperature or room temperature takes rather long time, this is mainly due to the large amount of ceramic material which require slow heating ramps. If the system is at operating temperature the stack can be started up quickly, assuming that gases are supplied and help systems are active. Also shut down can be performed quickly, not counting in the time required to cool the system.
- I The best estimates for nominal investments in 2020, 2030 and 2050 are estimated from [9]. In 2020 an annual production of 50 units is assumed, in 2030 a yearly production of 250 units is assumed, and in 2050 a production of 4000 units per year is assumed.
- J Estimation of uncertainties for investment costs are estimated from [9] with an annual production of 10/150 units in 2020 and 1000/10000 units in 2050
- K Fixed O&M costs are estimated as 5% of the investment cost.
- L The heat efficiency, which can be derived, depends on the return temperature of the cooling circuit and the size of the heat exchanger.

References

- [1] BloomEnergy, www.bloomenergy.com, 2014-11-11,
- [2] Technology, <https://www.mhps.com/en/technology/index.html>, 2014-11-14.
- [3] BloomEnergy, *Product datasheet: ES-5710 Energy Saver*, November 2014:
http://c0688662.cdn.cloudfiles.rackspacecloud.com/downloads_pdf_Bloomenergy_DataSheet_ES-5710.pdf.
- [4] BloomEnergy, *Product datasheet: ES-5700 Energy Saver*, November 2014:
http://c0688662.cdn.cloudfiles.rackspacecloud.com/downloads_pdf_Bloomenergy_DataSheet_ES-5700.pdf.
- [5] Iskov H., Rasmussen N.B., Danish gas Technology centre, 2013, *“Update of technology data for energy plants: Fuel cells, electrolysis and technologies for bio-SNG”*.
- [6] Fuel Cell and Hydrogen Joint Undertaking: *“Multi – Annual Work Plan 2014-2020”*, adopted 2014-06-30.
- [7] <http://www.asue.de>, 2014-11-17.
- [8] Bloom Energy Server, http://en.wikipedia.org/wiki/Bloom_Energy_Server, 2015-02-02.
- [9] Cogeneration in public facilities - flexible and green, <http://www.sunfire.de/en/applications/commercial>, 2016-08-31.
- [10] Convion product focus, <http://convion.fi/products/>
- [11] UPM-571 Uninterruptible Power Module, <http://www.bloomenergy.com/fuel-cell/upm-571-data-sheet/>, 2016-08-31.
- [12] International Energy Agency, 2015, *Technology Roadmap - Hydrogen and Fuel Cells*.
- [13] Pacific Northwest National Laboratory, 2013, *Cost Study for Manufacturing of Solid Oxide Fuel Cell Power Systems*, prepared for the U.S. Department of Energy.
- [*] An asterisk in the data sheets reference indicate high uncertainty or "guesstimate", where more certain data were not available

12 Low temperature proton exchange membrane fuel cell CHP (hydrogen)

Contact information:

Danish Energy Agency: Rikke Næraa, rin@ens.dk

Energinet: Rune Grandal, rdg@energinet.dk

Author: Dantherm. Adaptation from *Technology Data for Hydrogen Technologies* by Ea Energy Analyses

Review: DGC

Publication date

March 2018

Amendments after publication date

Date	Ref.	Description
-	-	-
-	-	-

Qualitative description

Brief technology description

Fuel cells are electrochemical devices that convert fuel into electricity and heat. Generally, the conversion efficiency from fuel to electricity is high in a fuel cell and the technology is scalable without loss of efficiency. The proton exchange membrane (PEM) fuel cell consists of a cathode and an anode made of graphite and a proton-conducting polymer as the electrolyte as shown in Figure 1 [1].

Low temperature PEM fuel cells operate at temperatures below 100°C (typically around 80°C) since the membrane must be saturated by water.

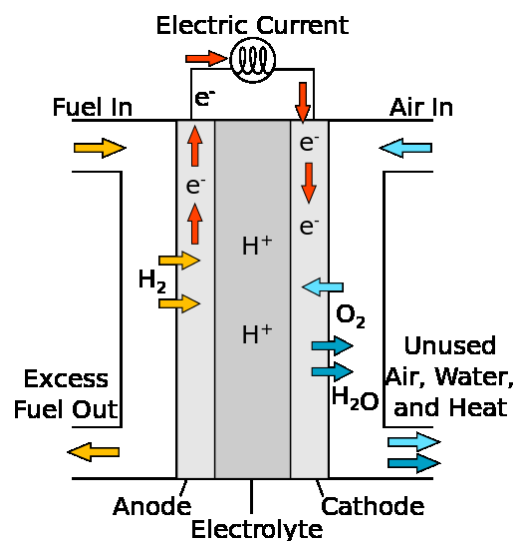

Figure 1: Diagram of a PEM-FC [2].

Today, the larger power and heat generating units FC-CHP are typically arranged for integration in conjunction with industrial processes where hydrogen is a waste gas from the industrial processes e.g. production of chloric gas. In many of the early units, only the electricity as output is used. In the future, the hydrogen used for the fuel cell may be produced from electrolysis based on fossil free electricity.

Additionally, the potential of the LT-PEM fuel cell for transport purposes and within the area of mCHP installations has been estimated to be significant [1].



Figure 2: A 50 kW LT-PEMFC CHP hydrogen unit from Dantherm Power.

Input

Hydrogen.

Output

Electricity and heat.

Typical capacities

The larger FC-CHP units are typical around 20 to 1,000 kW of electrical power.

Regulation ability

The technology has good part-load and transient properties. The regulation of PEM systems can be designed to achieve close to 0% nominal load without significant loss of efficiency. Furthermore, the start-up time of the technology is short and the fuel cells can start and operate at room temperature and has no problems with

frequent thermal cycling (start/stop). Response time from cold start during hard frost is very short – down to a few seconds.

Advantages/disadvantages

The main advantages include:

- The PEM-FC utilises the scalability of the fuel cell technology to produce electricity locally with efficiencies equal to or higher than for conventional power plants.
- Larger FC-CHP units in the grid can support the grid companies in balancing the grid.
- The grid balancing property of the PEM-FC contributes to reduced additional investments in infrastructure e.g. cables.
- Hydrogen produced from excess electricity based on renewable sources can be stored in hydrogen storages and utilised in the PEM-FC in situations, where wind turbines, solar PV and other renewable technologies are not available.

The main disadvantages include:

- Relatively high production costs today due to expensive materials (platinum).
- The lifetime of the current technology needs to be improved.

Environment

If the hydrogen is produced from fossil free electricity, the operation of the LT-PEMFC is carbon neutral.

The exhaust gas does not contain NO_x and SO₂.

Research and development perspectives

The Danish research, development and demonstration program on fuel cell based CHP is of international level compared to similar programs in Germany, Japan, Korea and North America.

The fuel cell technology has shown high electrical efficiency above the efficiencies of competing power generation technologies. However, the fuel cell technology still needs to be matured on issues like lifetime and cost reduction. It is expected that the Danish fuel cell technology will mature to a commercial level within this decade.

Examples of market standard technology

Demonstration plants of 50 kW FC-CHP units were produced by Dantherm Power in 2010 and 2011 and delivered to South Africa and South Korea. A 1,000 kW unit from Nedstack was set in operation in 2011 in Arnhem, Holland; the Ballard Power Systems 1,000 kW unit has been in operations in California since 2012.

Prediction of performance and costs

Since the technology is still relatively immature, the technology is placed in Category 2: Pioneer phase, demonstration. This also means that there is significant uncertainty related to the projection of future costs, which relate to both overcoming technological challenges and the future market and demand for the technology.

In the Technology Data for Hydrogen Technologies [4], the investment costs are projected to decrease to 1.1 M€₂₀₁₅/MW by 2030 and 0.8 M€₂₀₁₅/MW by 2050. For comparison the IEA projects a decrease from 1.5 M€/MW in 2020 to 0.7 M€/MW in 2030 and 0.6 M€/MW by 2050, in its Technology Roadmap - Hydrogen and Fuel Cells, 2015.

The typical generation capacity is expected to increase from around 0.1 MW in 2020 to approximately 2 MW in 2050, while the electrical efficiency is expected to increase to 50%.

Uncertainty

The uncertainty related to the cost projection is significant and is affected by challenges such as lifetime improvements, introduction of cheaper materials and improved market share resulting in economy of scale synergies. The uncertainty of the cost projection in 2050 is estimated to be +/- 50%.

Economy of scale

-

Additional remarks

No additional remarks.

Data sheets

Technology	LT-PEMFC CHP hydrogen gas									
	2015	2020	2030	2050	Uncertainty (2020)		Uncertainty (2050)		Note	Ref
Energy/technical data					Lower	Upper	Lower	Upper		
Generating capacity for one unit (MWe)	0.05	0.1	1	2						1
Electricity efficiency (condensation mode for extraction plants), net (%), name plate	45	50	50	50						1
Electricity efficiency (condensation mode for extraction plants), net (%), annual average	45	50	50	50	45	52	46	53	A	1, 2
Cb coefficient (50°C/100°C)	-	1.25	1.25	1.25					D	
Cv coefficient (50°C/100°C)	-	-	-	-						
Forced outage (%)	0.1	0.1	0.1	0.1						
Planned outage (weeks per year)		0.1	0.1	0.1						
Technical lifetime (years)	10	10	10	10						1
Construction time (years)	1	1	1	1						
Regulation ability										
Primary regulation (% per 30 seconds)	50	25	2.5	1.25						
Secondary regulation (% per minute)										
Minimum load (% of full load)	10	10	10	10						
Warm start-up time (hours)	0.01	0.01	0.01	0.01						
Cold start-up time (hours)										
Environment										
SO ₂ (degree of desulphuring, %)	100	100	100	100						
NO _x (g per GJ fuel)	0	0	0	0						
CH ₄ (g per GJ fuel)	0	0	0	0						
N ₂ O (g per GJ fuel)	0	0	0	0						
Financial data										
Nominal investment (M€/MW)	1.9	1.3	1.1	0.8	1.1	1.6	0.5	0.9	B	3, 2
- of which equipment	1.6	1.0	0.8	0.6						3
- of which installation	0.3	0.3	0.3	0.2						3
Fixed O&M (€/MW/year)	95,000	65,000	55,000	40,000					C	
Variable O&M (€/MWh)										
Technology specific data										
Minimum load efficiency (%)	30	35	35	35						1

Notes:

- A Uncertainties for efficiency based on [2]
- B Estimation of uncertainties for nominal investment costs based on [2]
- C Fixed O&M costs are estimated to 5% of the investment cost based on [2]
- D The heat efficiency, which can be derived, depends on the return temperature of the cooling circuit and the size of the heat exchanger.

References

- [1] Partnerskabet for brint og brændselsceller, *Fuel Cell Technologies*, <http://www.hydrogennet.dk/358/>, visited 01.11.2016.
- [2] Wikipedia, Proton exchange membrane fuel cell, https://en.wikipedia.org/wiki/Proton_exchange_membrane_fuel_cell, visited 01.11.2016.
- [3] International Energy Agency. 2015. *Technology Roadmap - Hydrogen and Fuel Cells*.
- [4] Ea Energy Analyses et al. 2016, *Technology Data for Hydrogen Technologies*.
- [5] Practical data and expert opinion from Dantherm Power

20 Wind Turbines onshore

Contact information:

Danish Energy Agency: Rikke Næraa, rin@ens.dk

Author: Mads V. Sørensen / Per Nielsen (EMD)

Publication date

August 2016

Amendments after publication date

Date	Ref.	Description

Qualitative description

Brief technology description

The typical large onshore wind turbine being installed today is a horizontal-axis, three bladed, upwind, grid connected turbine using active pitch, variable speed and yaw control to optimize generation at varying wind speeds.

Wind turbines work by capturing the kinetic energy in the wind with the rotor blades and transferring it to the drive shaft. The drive shaft is connected either to a speed-increasing gearbox coupled with a medium- or high-speed generator, or to a low-speed, direct-drive generator. The generator converts the rotational energy of the shaft into electrical energy. In modern wind turbines, the pitch of the rotor blades is controlled to maximize power production at low wind speeds, and to maintain a constant power output and limit the mechanical stress and loads on the turbine at high wind speeds. A general description of the turbine technology and electrical system, using a geared turbine as an example, can be seen in figure 1.

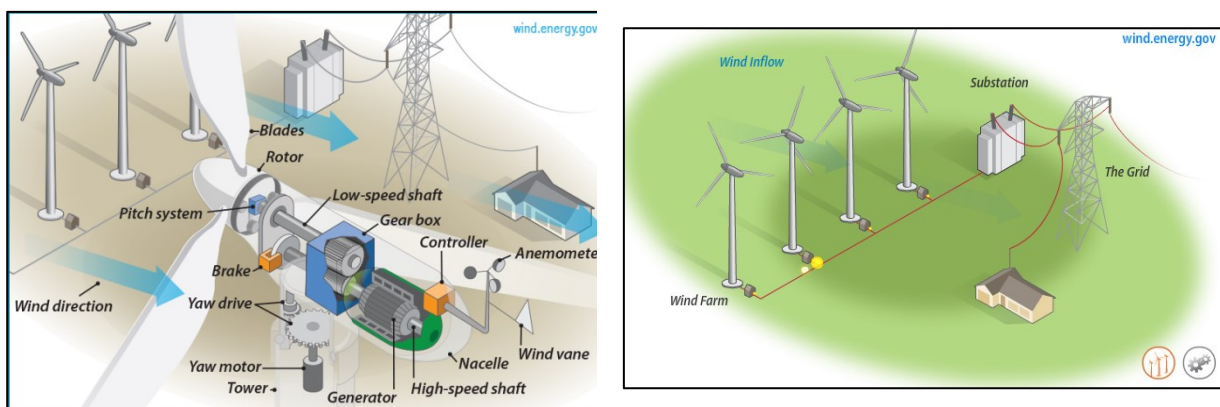

Figure 1: General turbine technology and electrical system.

Wind turbines are designed to operate within a wind speed range which is bounded by a low “cut-in” wind speed and a high “cut-out” wind speed. When the wind speed is below the cut-in speed the energy in the wind is too low to be utilized. When the wind reaches the cut-in speed, the turbine begins to operate and produce electricity. As the wind speed increases, the power output of the turbine increases, and at a certain wind speed the turbine reaches its rated power. At higher wind speeds, the blade pitch is controlled to maintain the rated power output. When the wind speed reaches the cut-out speed, the turbine is shut down or operated in a reduced power mode to prevent mechanical damage.

Onshore wind turbines can be installed as single turbines, clusters or in larger wind farms.

Commercial wind turbines are operated unattended, and are monitored and controlled by a supervisory control and data acquisition (SCADA) system.

Input

Input is wind.

Cut-in wind speed: 3 – 4 m/s.

Rated power generation wind speed: 10-12 m/s, depending on the specific power (defined as the ratio of the rated power to the swept rotor area).

Cut-out or transition to reduced power operation at wind speed: 25 m/s.

In the future, it is expected that manufacturers will apply a soft cut-out for high wind speeds (indicated with dashed red curve in figure 2) resulting in a final cut-out wind speed around 30 m/s.

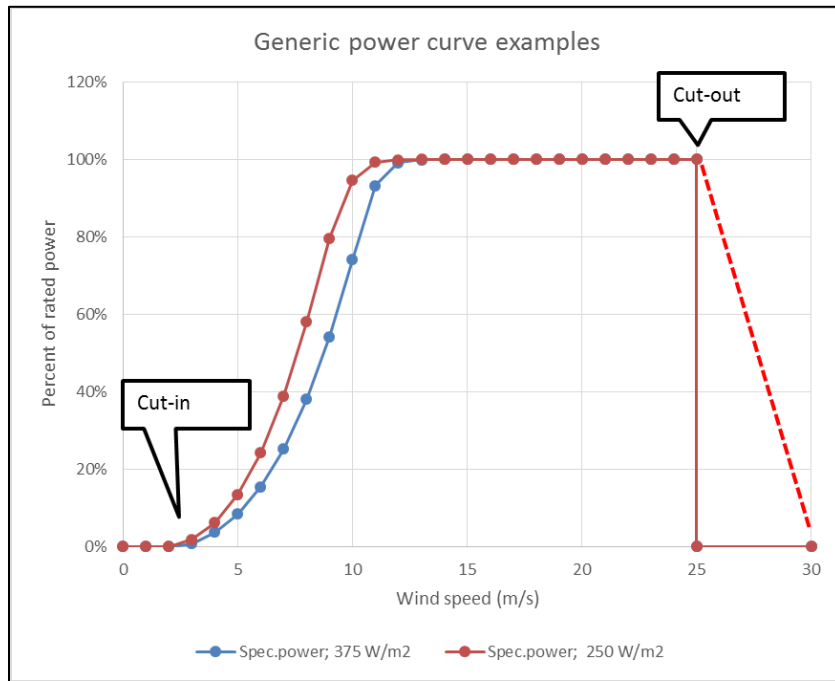

Figure 2: Turbine power curves (Information's from expert workshop held by DEA 27-4-2015) Specific power values refer to e.g. 3 MW with 124m rotor diameter (250 W/m²) and 3 MW with 101 m rotor diameter (375 W/m²)

The power in the wind is given by the formula $P = \frac{1}{2} \cdot \rho \cdot A \cdot u^3$, where ρ is the air density, A the swept area and u the wind speed. To calculate the net power output from a wind turbine, the result must be multiplied by C_p (Coefficient of power). C_p varies with wind speed and has a maximum of around 45%, which is typically reached at ~ 8 m/s, depending on the specific power.

Output

The output is electricity.

Typical modern onshore turbines located in Denmark have capacity factors in the range of 33%, corresponding to 2900 annual full load hours. Typical duration curves are presented in figure 3.

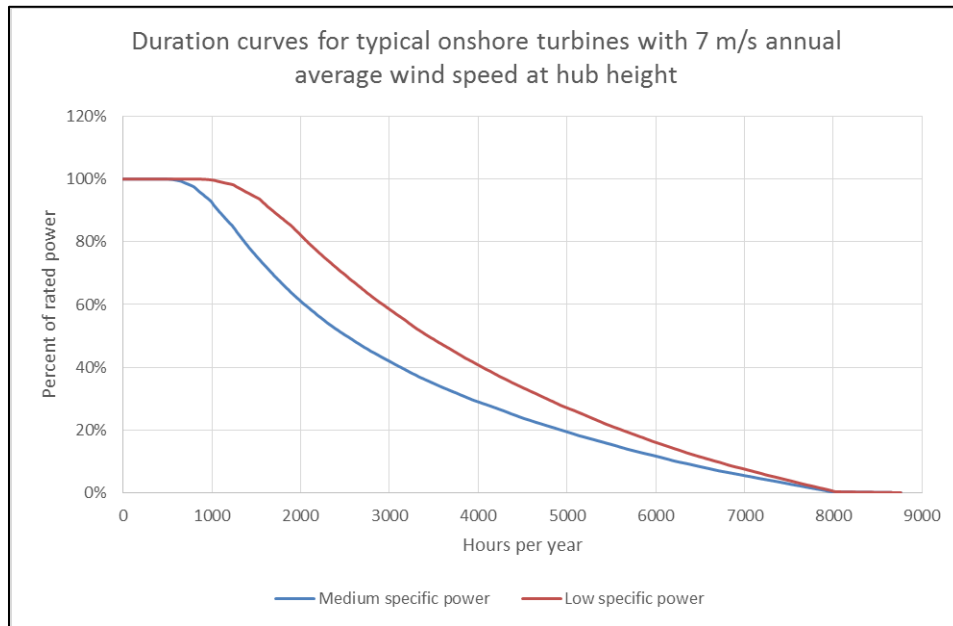

Figure 3: Duration curve for typical modern onshore wind turbines (> 2 MW) located in Denmark (DTU International Energy Report - Wind Energy, 2014). The two curves are based on the V117 3.3 MW (307 W/m²) and V126 3.3 MW (265 W/m²) wind turbines.

The annual energy output of a wind turbine is strongly dependent on the average wind speed at the turbine location. The average wind speed depends on the geographical location (with Northwestern Jutland being the windiest part of Denmark), the hub height, and the surface roughness. Hills and mountains also affect the wind flow, but as Denmark is very flat, the local wind conditions are normally dominated by the surface roughness. Also local obstacles like forest and for small turbines buildings and hedges reduce the wind speed like wakes from neighbor turbines reduces.

The surface roughness is normally classified according to the following table:

Roughness class	Roughness Length (m) ⁹	Description

⁹ The roughness length is the height above ground level, where average wind speed is 0. The wind speed variation with height is governed by the roughness length.

0	0.0002	Water
1	0.03	Open farmland
2	0.1	Partly open farmland with some settlements and trees
3	0.4	Forest, cities, farmland with many windbreaks

Table 1: Description of classification of surface roughness

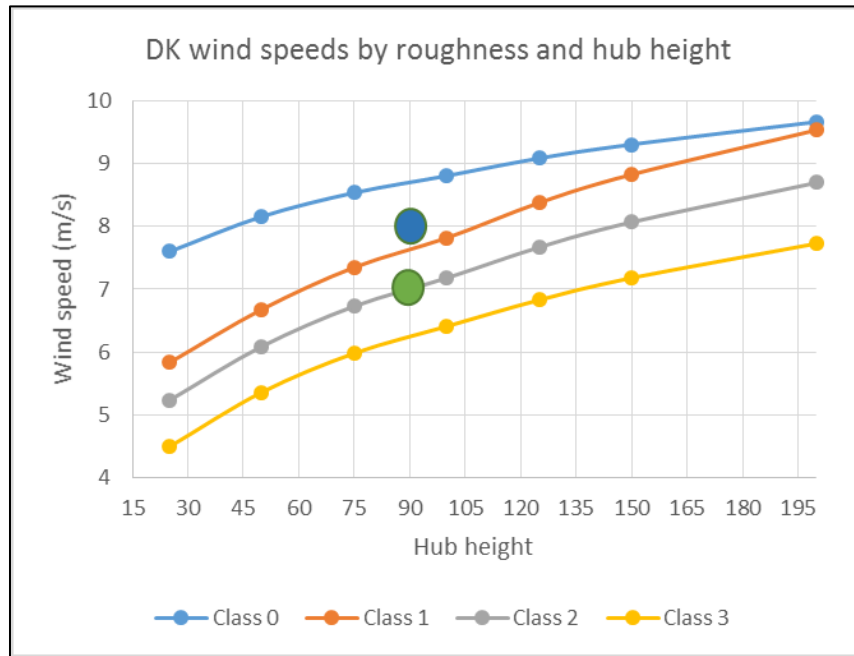

Figure 4: Annual average wind speeds as a function of hub height and roughness class for flat terrain. The green dot represents a typical modern inland site; the blue dot represents a typical coastal site. The typical hub height is 90 m.

Figure 4 shows the average wind speeds by hub height and roughness class for flat terrain. Onshore wind turbines installed in Denmark today typically have a hub height of 90 m. On a typical inland site the average wind speed is around 7 m/s, whereas on a typical coastal site the average wind speed is around 8 m/s. An increase in the average wind speed from 7 to 8 m/s results in a roughly 25% increase in annual energy production.

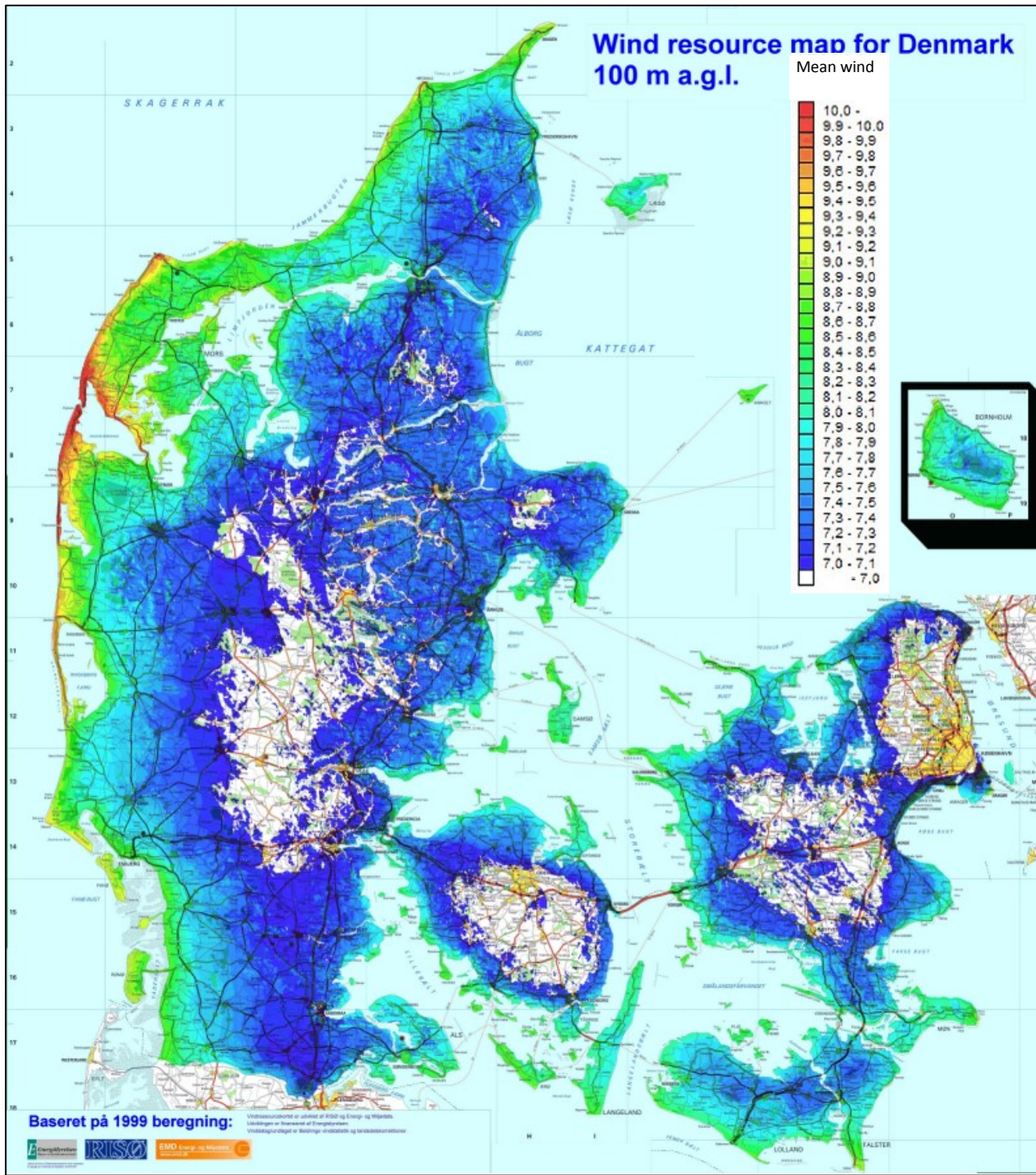

Figure 5: Wind resource map for Denmark in 200 m resolution, 100 m above terrain¹⁰.

The wind resource map for Denmark (figure 5) shows the regional differences. As seen, the regions close to the sea in dominating wind directions (west-southwest) that have the highest wind resource. This is a result of the low surface roughness in the upwind direction. The white areas have average wind speeds below 7 m/s at 100 m height above terrain.

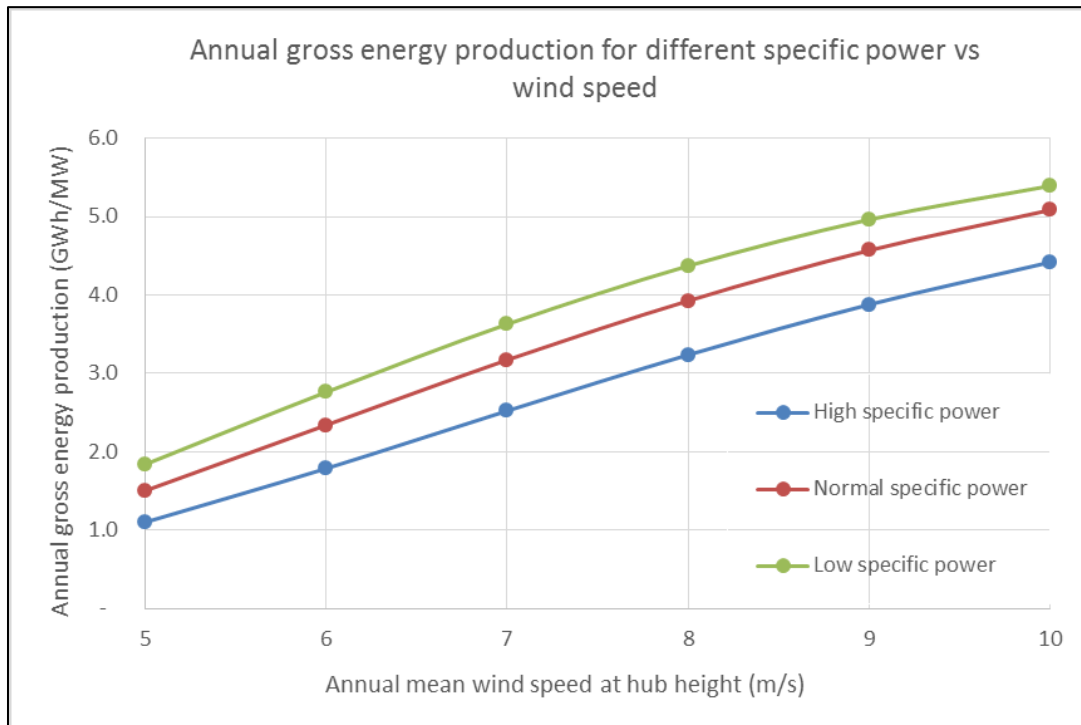

Figure 6: Annual gross Energy Production (AEP) as a function of mean wind speed at hub height. The examples in the figure are 3 MW with 90m rotor diameter, specific powers are 472 W/m² called “high specific power” and 3.3 MW turbines with 112 m and 126 m rotor diameters, specific powers are 335 W/m² called “medium specific power” and 265 W/m² called “low specific power”.

Figure 6 illustrates the importance of the annual mean wind speed as well as the specific power for the annual energy production (AEP). It is seen that the increase in AEP is almost linear with mean wind speed in the range from 6m/s to 9 m/s.

Typical capacities and development statistics

Onshore wind turbines can be categorized according to nameplate capacity. At the present time new installations are in the range of 2 to 6 MW. Another category is domestic wind turbines which is micro and small wind turbine in the range of 1 -25 kW, see separate paragraph on domestic turbines.

¹⁰ The resource map is to a large extent calibrated with reference to the period 1985-95. This period has later turned out to have above-average wind speeds relative to long-term averages. Current estimates of long-term average wind speeds are roughly 3% lower than the wind speeds shown in the map.

Two primary design parameters define the overall production capacity of a wind turbine. At lower wind speeds, the electricity production is a function of the swept area of the turbine rotor. At higher wind speeds, the power rating of the generator defines the power output. The interrelationship between the mechanical and electrical characteristics and their costs determines the optimal turbine design for a given site.

The size of wind turbines in Denmark has increased steadily over the years. Larger generators, larger hub heights and larger rotors have all contributed to increase the electricity generation from wind turbines. Lower specific capacity (increasing the size of the rotor area more than proportionally to the increase in generator rating) improves the capacity factor (energy production per generator capacity), since power output at wind speeds below rated power is directly proportional to the swept area of the rotor. Furthermore, the larger hub heights of larger turbines provide higher wind resources in general.

The average rated power of new onshore wind turbines in Denmark has increased by a factor of three since year 2000 (Figure 7 below). Although project developers consider larger turbines to be the most attractive, the increase in rated power is not constant, partly because some older projects with smaller turbines have been expanded with more (small) turbines, and partly because some projects are established with smaller turbines than the “optimal” size due to lack of space.

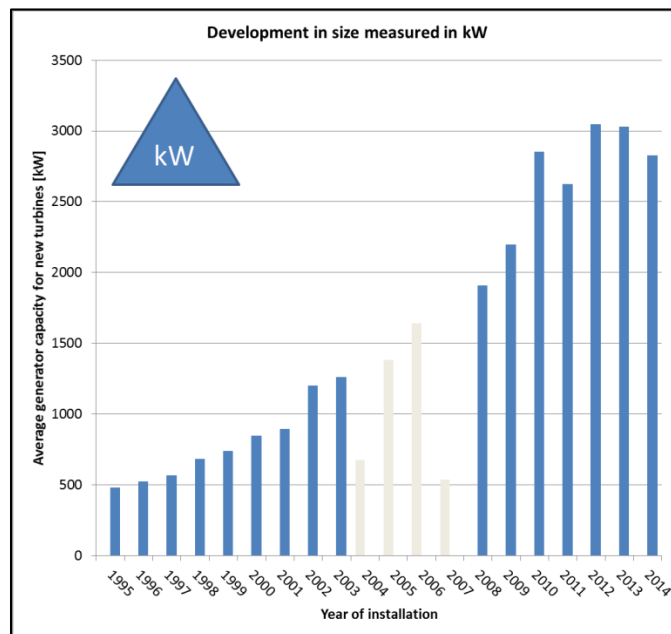

Figure 7: Average generator capacity for new turbines (rated power > 0.5 MW) [3]

In the same period the rotor diameters and hub heights have also increased as illustrated in figure 8 and 9.

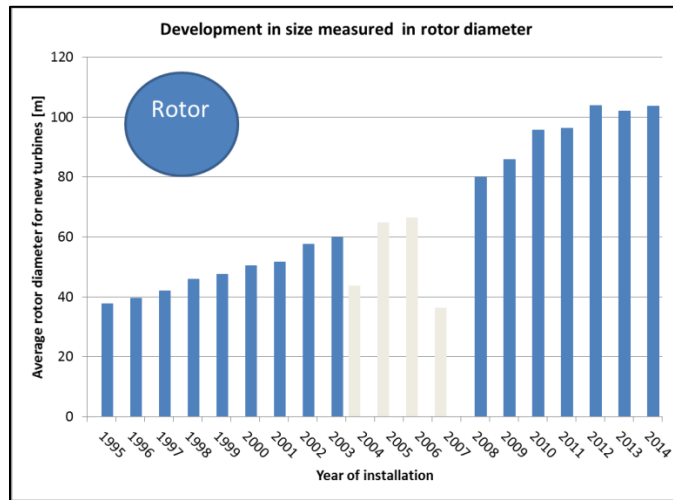

Figure 8: Average rotor diameter for new turbines (rated power > 0.5 MW) [3]

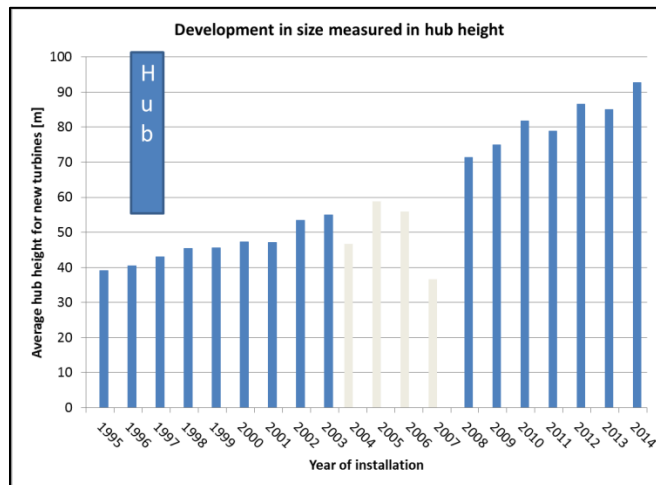

Figure 9: Average hub height for new turbines (rated power > 0.5 MW) [3]

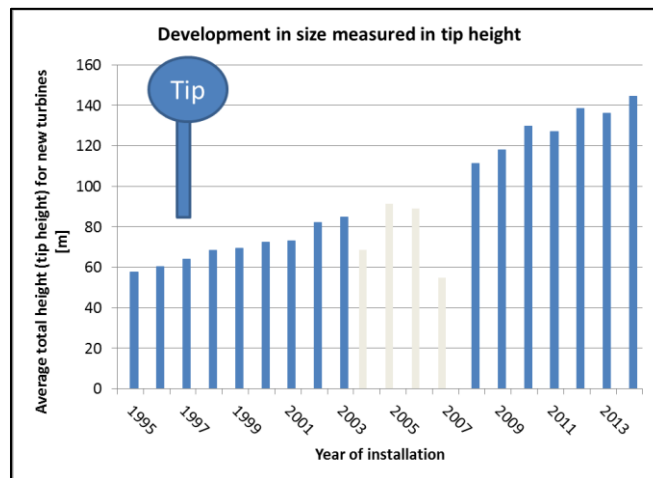

Figure 10: Average tip height for new turbines (rated power > 0.5 MW) [3]

The specific power has decreased for turbines installed in Denmark over the last 10 years. Formerly, turbines often had specific power values on the order of 400-450 W/m². Since 2010 the average specific power has generally been less than 375 W/m². In combination with improvements in turbine efficiency and an increase in average hub heights, this has resulted in increasing capacity factors. On average, capacity factors for Danish onshore turbines installed before 2000 were below 25% (corresponding to 2200 full load hours), while the average capacity factors for Danish onshore turbines installed after 2010 are typically in the order of 30-35% (corresponding to 2600-3100 full load hours). The trend towards larger rotors and lower specific power is global.

Due to current planning, environmental and civil aviation regulations wind turbines to be installed onshore in Denmark are generally limited to a maximum height of 150 m from the ground to the highest point i.e. rotor tip. In 2014 the average total height (tip height) was 145 m [4]. However, exemptions from the 150 m limit are granted for test sites. Elsewhere in Europe there is a strong trend towards approval of maximum heights above 150 m. An amendment of the Danish maximum height restriction could affect the future development in turbine dimensions.

Regulation ability and power system services

Electricity from wind turbines is highly variable because it depends on the actual wind resource available. Therefore, the regulation capability depends on the weather situation. In periods with calm winds (wind speed less than 4-6 m/s) wind turbines cannot offer regulation, with the possible exception of voltage regulation.

With sufficient wind resource available (wind speed higher than 4-6 m/s and lower than 25-30 m/s) wind turbines can always provide down regulation, and in many cases also up regulation, provided the turbine is running in power-curtailed mode (i.e. with an output which is deliberately set below the possible power based on the available wind).

In general, a wind turbine will run at maximum power according to the power curve (c.f. figure 10) and up regulation is only possible if the turbine is operated at a power level below the power actually available. This

mode of operation is technically possible and in many countries, turbines are required to have this feature. However, it is rarely used, since the system operator will typically be required to compensate the owner for the reduced revenue [5].

Wind turbine generation can be regulated down quickly and this feature is regularly used for grid balancing. The start-up time from no production to full operation depends on the wind resource available.

New types of wind turbines (DFIG and converter based) also have the ability to provide supplementary ancillary services to the grid such as reactive power control, spinning reserve, inertial response, etc. However, these supplementary ancillary services from wind turbines are seldom utilized in Denmark, due to a lack of economic incentives. Older types of wind turbines typically deployed in Denmark before 2008 consume reactive power and can have a negative influence on voltage stability.

Advantages/disadvantages

Advantages:

- No emissions to air from operation
- No emission of greenhouse gasses from operation
- Stable and predictable costs due to low operating costs and no fuel costs
- Modular technology allows for capacity to be expanded according to demand avoiding overbuilds and stranded costs
- Short lead time compared to most alternative technologies

Disadvantages:

- High capital investment costs
- Variable energy resource
- Moderate contribution to capacity compared to thermal power plants
- Need for regulating power
- Visual impact and noise

Environment

Wind energy is a clean energy source. The main environmental concerns are visual impact, flickering from rapid shifts between shadow and light when turbine is between sun and settlement, noise and the risk of bat or bird-collisions.

The visual impact of wind turbines is an issue that creates some controversy, especially since onshore wind turbines have become larger.

Flickering is generally managed through a combination of prediction tools and turbine control. Turbines may in some cases need to be shut down for brief periods when flickering effect could occur at neighbouring residences.

Noise is generally dealt with in the planning phase. Allowable sound emission levels are calculated on the basis of allowable sound pressure levels at neighbours. In some cases it is necessary to operate turbines at reduced rotational speed and/or less aggressive pitch setting in order to meet the noise requirements. Noise reduced operation may cause a reduction in annual energy production of 5-10%. Despite meeting the required noise emission levels turbines sometimes give rise to noise complaints from neighbours. In 2013 it was decided to investigate in detail how wind turbines and especially noise from wind turbines influence human health. A conclusion on the work is expected by end of 2015 [6]. A recent Canadian literature study concludes that wind turbines might cause annoyance at the neighbours, but no causal relation could be established between noise from wind turbines and the neighbour's health [7].

The risk of bird collisions has been of concern in Denmark due to the proximity of wind turbines to bird migration routes. In general, it turns out that birds are able to navigate around turbines, and studies report low overall bird mortality but with some regional variations [8].

The environmental impact from the manufacturing of wind turbines is moderate and is in line with the impact of other normal industrial production. The mining and refinement of rare earth metals used in permanent magnets is an area of concern [2, 9, 10].

The energy payback time of an onshore wind turbine is in several studies calculated to be in the order of 3-9 months [11, 12].

Life-cycle assessment (LCA) studies of wind farms have concluded that environmental impacts come from three main sources:

- bulk waste from the tower and foundations, even though a high percentage of the steel is recycled
- hazardous waste from components in the nacelle
- greenhouse gases (e.g. CO₂ from steel manufacturing and solvents from surface coatings)

Research and development perspectives

R&D potential: [2, 13]

- Reduced investment costs resulting from improved design methods and load reduction technologies
- More efficient methods to determine wind resources, incl. external design conditions, e.g. normal and extreme wind conditions
- Improved aerodynamic performance
- Reduced operational and maintenance costs resulting from improvements in wind turbine component reliability
- Development in ancillary services and interactions with the energy systems
- Improved tools for wind power forecasting and participation in balancing and intraday markets
- Improved power quality. Rapid change of power in time can be a challenge for the grid
- Noise reduction. New technology can save the losses by noise reduced mode and possible utilize good sites better, where the noise set the limit of number of turbines
- Public acceptance

- Repowering strategies, like when it is feasible to repower for society and for investors – subsidy schemes must support optimal solutions
- Storage can improve value of wind power much, but is expensive at present

Examples of best available technology

Presently only Siemens and Vestas have commercially approved turbines suitable for Danish onshore projects. The wind turbines offered have rated power in the 2–4 MW range and rotor diameters of 80-130 m. Hub heights are typically in the range of 80-100 m.

Prediction of performance and cost

Cost breakdown of total capital costs for onshore wind turbines

The capital costs of onshore wind power projects are dominated by the cost of the wind turbine itself. Figure 11 shows the breakdown of an average project in Denmark. The cost of grid connection is covered by the Transmission System Operator (TSO) and does not appear in the cost breakdown. Grid connections are generally 3 to 7 % of total investment costs.

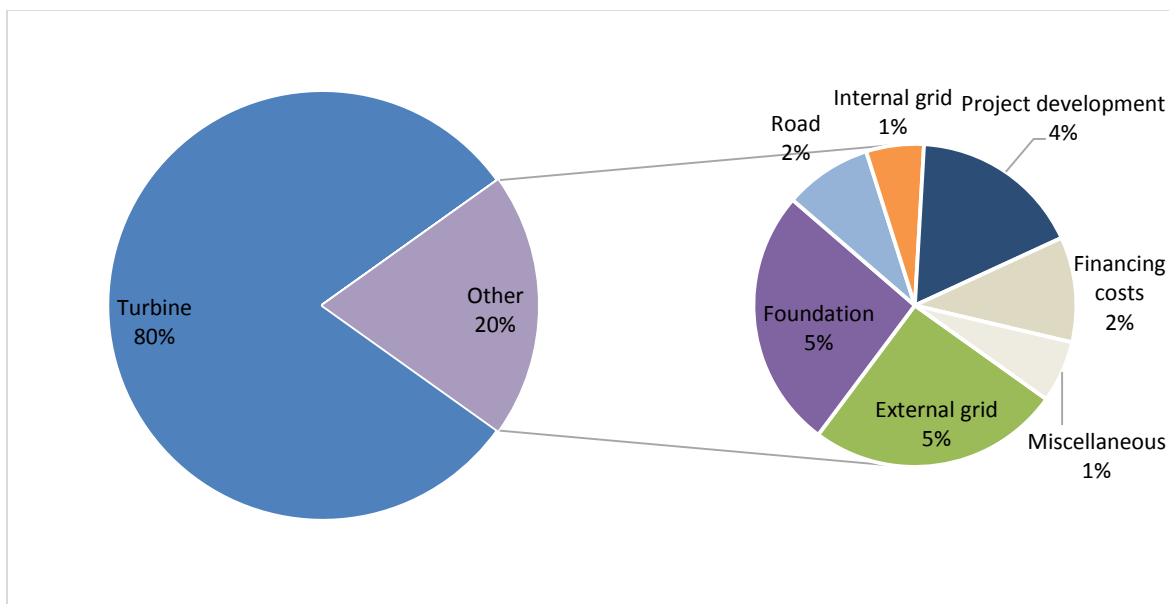

Figure 11 Breakdown of capital costs for a typical wind power project in Denmark¹¹ [14]

Not included in the cost breakdown are the following supplementary project costs:

- Cost of land

¹¹ The cost breakdown is based on recent projects published through the “køberetsordning”, where neighbours to new projects have the right to purchase 20% of the projects at actual cost of the projects. Thereby the detailed cost breakdown must be made public available.

- Compensation for loss of value for nearby settlements (Værditabsordningen)
- Purchase of existing turbines to be dismantled at site or nearby
- Purchase of nearby settlements to free space for the project

These costs are highly variable from project to project and can vary from 0% to round 25% of the total investment, depending on the local situation. These costs will be on top of the costs shown in figure 11.

There are four major components in operation and maintenance costs for wind turbines in Denmark: service agreement, insurance, land rent/administration and repairs not covered by service agreement. Each cost component accounts roughly for 25% of Operating and Maintenance (O&M) costs over the lifetime of a wind turbine [4]. For more recent projects the trend is that the service agreement cover more and insurance and repair cost will represent a lower percentage.

A major part of the most recent onshore wind turbines are delivered with long term service contracts (more than 10-15 years) provided by the turbine manufacturers and a large part of the service/maintenance costs is known upfront. However, it is difficult to estimate the costs for repairs not covered by the service agreement, and even with long-term service agreements unforeseen cost may occur [15].

A study based on data for 2009 reports the expected lifetime costs for O&M for wind turbines installed in Denmark to be approximately €12/MWh (2015 prices) [4]. This is in accordance with the latest experience from the Danish Wind Turbine Owners association, which estimates a lifetime O&M-cost of 11 €/MWh (2015 prices) [15].

Cost and production dependence of hub height and specific power

To identify main drivers for future technology a deeper look is taken on how the production changes relative to the cost of the turbines by different parameter variations.

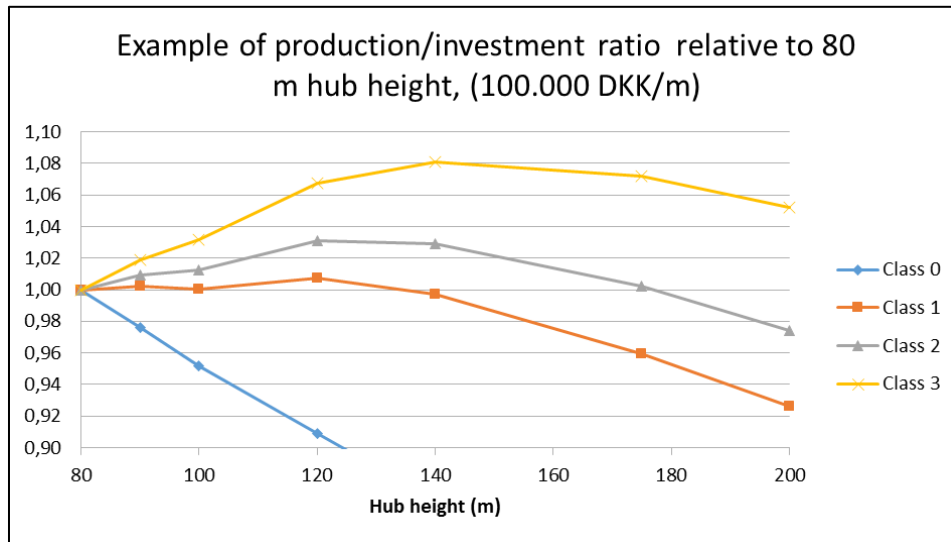

Figure 12: The production increase relative to the investment cost based on current available Vestas turbines. By increasing height, costs are extrapolated using DKK 100.000 per m hub height increase; the rotor area is kept constant.

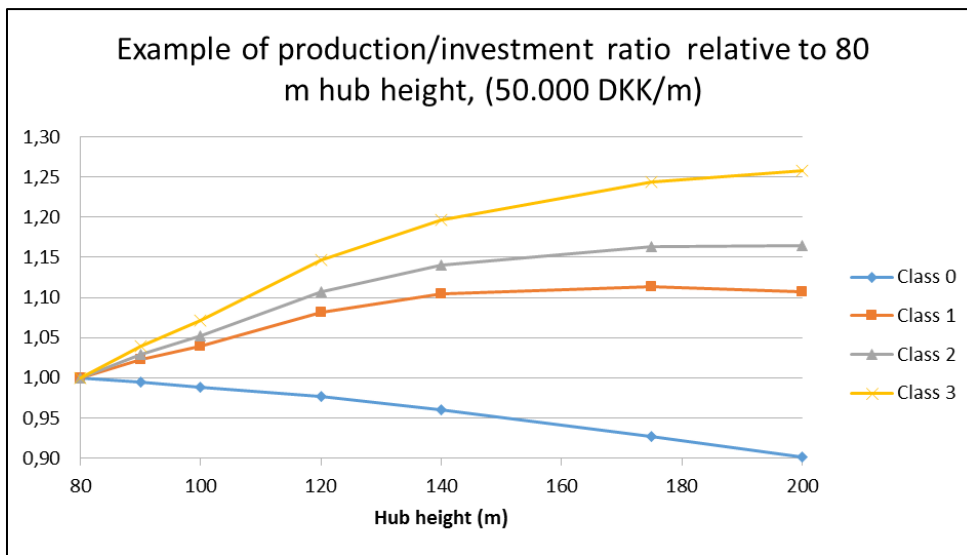

Figure 13: Similar, the production increase relative to the investment cost based on current available Vestas turbines, for increasing height, where costs are extrapolated using DKK 50.000 per m hub height increase, the rotor area is kept constant.

Figure 12 and 13 demonstrate that except for in the offshore roughness class 0 hub heights above today's standard would lead to improved cost efficiency. In countries like Germany and Sweden, the improvements are generally at the higher end due to a higher average roughness class, and in the recent years 140m hub height are becoming common in commercial projects.

While the assumed cost increase of DKK 50-100.000 per meter hub height increase is within the range seen of present technologies, many other factors contribute to the cost increase with height, such as the specific tower technology, the project location relative to manufacturing, and the available cranes. Consequently, the cost

increase will not be linear with height (as assumed in the figures), and the figures should be taken as a general illustration of the potential cost reductions by increased hub heights.

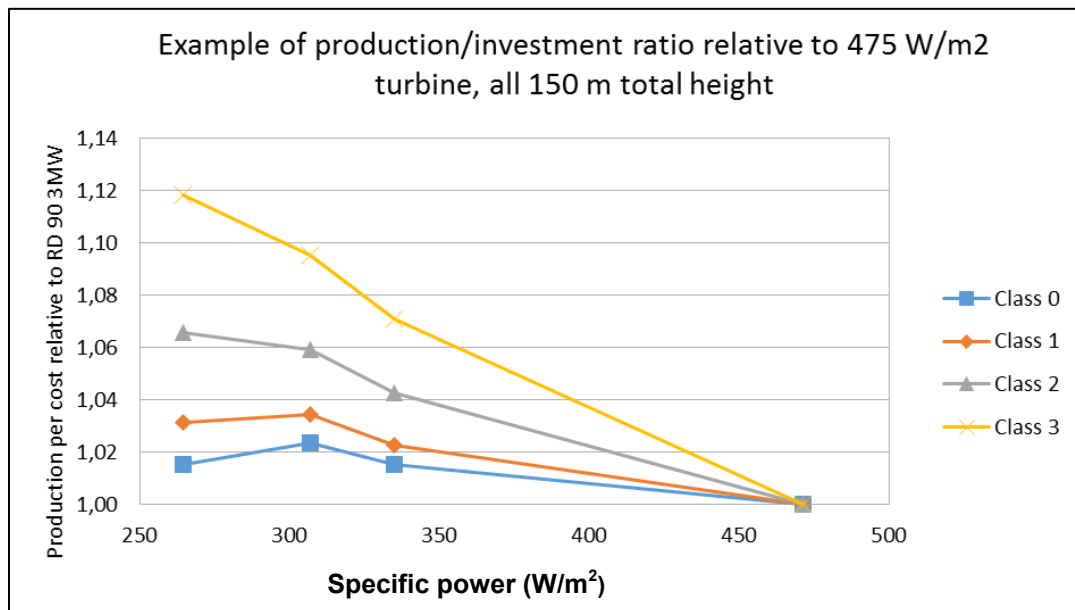

Figure 14: The production relative to the investment cost based on current available Vestas turbines for different rotor areas, generator size is 3-3.3 MW for all (= different specific power).

Cost optimization leads to smaller generators for the same rotor area with limited loss of production. In order to support this optimization the subsidy system is now based more on rotor area and less on generator size.

Figure 14 illustrates the potential benefits from reduction of the specific power. Modern turbines with a specific power of less than 300 W/m² have up to 12% improvement in energy production per cost when comparing a typical turbine of 2010 vintage (90 m rotor; 3 MW; rated power 475 W/m²). If the improvement due to hub height increase would be included, even higher improvements would be seen.

To some extent the average capacity factors of onshore turbines installed since 2010 are affected by noise reduced operation due to noise regulations. Typically, noise reduced operation results in around 5% lower annual production than if non-noise reduced operation was possible. The noise reduced mode will typically reduce 5-10% with the Danish regulations, whereas higher reductions are seen in other countries.

Prediction of cost in 2015

The investment cost of wind turbines is expressed as investment per installed MW. This should however not stand alone when assessing the cost of the production of electricity from wind turbines. As mentioned before, the increase in hub height and rotor size of the turbine incurs additional investment costs per MW, but also increases the production per MW.

The development in the cost of wind turbines per installed MW and the numbers of full load hours are shown in figure 15 and 16. Costs increased between 2002 and 2008. This was due to increased size and technical complexity of wind turbines and increased costs of steel, other raw materials and labour during this period, increased mark-ups by wind turbine manufacturers, and the effects of supply chain shortages for wind turbines and key components.

At the same time the electricity production per MW (annual full load hours) increased due to increases in the size and other technological improvements.

Figure 15 illustrates how the energy production (annual full load hours) and the investment cost has developed since 1995. In figure 15 it is seen that in the recent years (2008-2014) the increase in energy production has been higher than the increase in investment costs.

The year-by-year variations are mainly a reflection of the sensitivity to the wind resource of actual project, rather than a year-to-year change in the technology used. Turbines installed during the period 2010-12 have the highest number of full load hours. This is probably most related to the fact that the majority of the turbines installed during this period are located in western Jutland which has the best wind resources in Denmark.

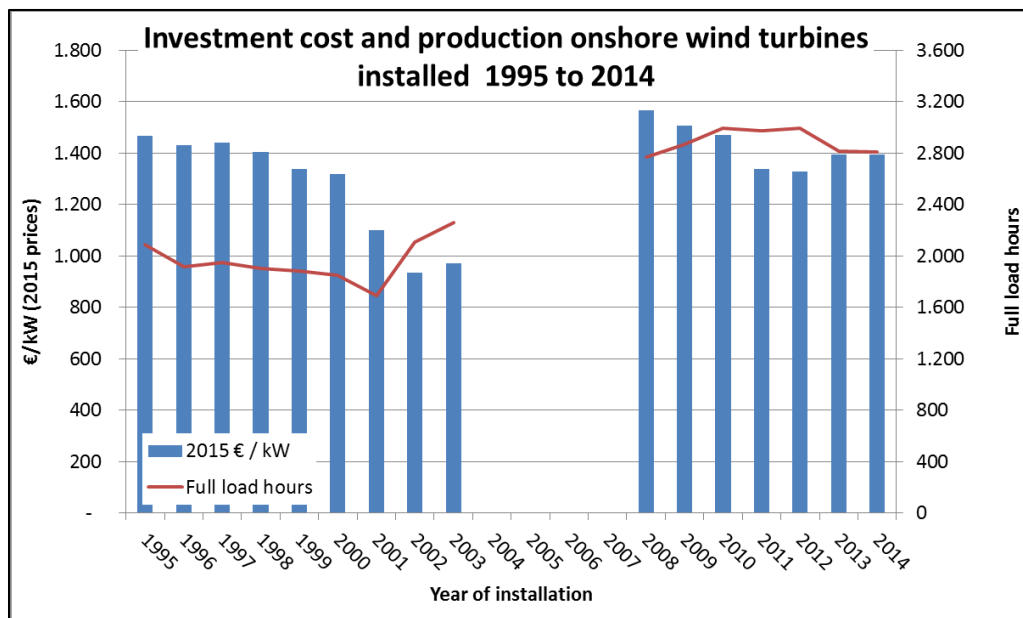

Figure 15: Development in investment cost (2015 price level) and average production (full load hours) for onshore turbines > 0.5 MW by installation year based on 2014 production¹² [3, 16, 2]

¹² For turbines installed in 2014; only turbines with more than 5 months of production is included and the production is normalized to a full year.

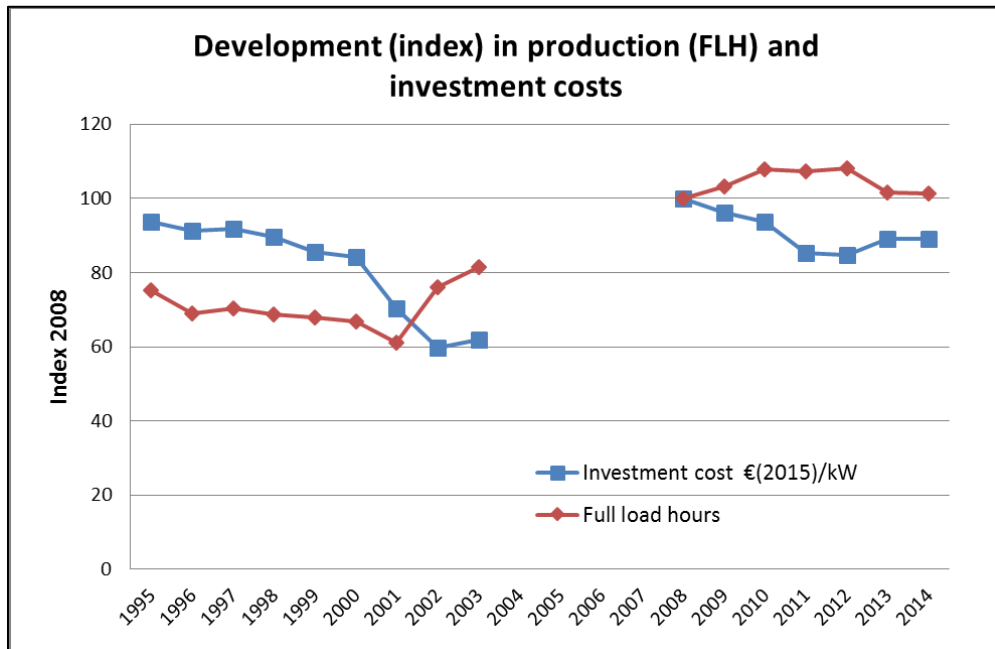

Figure 16: Development (index 2008=100) in investment cost (2015 price level) and average production (full load hours) for onshore turbines > 0.5 MW by installation year based on 2014 production [3, 16, 2]

Data from the most recent projects, which has been agreed 2013 and 2014 showed that the average investments prices for these projects are approximately 1,2 €/kW [14].

Prediction of cost in the period from 2015 to 2050

Onshore wind turbines can be seen as off-the-shelf products, but technology development continues at considerable pace, and the cost of energy has continued to drop. While price and performance of today’s onshore wind turbines are well known, future technology improvements, increased industrialization, learning in general and economics of scale are expected to lead to further reductions in the cost of energy. Consequently, despite the fact that more than 350.000 MW of onshore wind has been deployed worldwide, onshore turbines are categorized as development category 3; *Commercial technologies with moderate deployment*, with a significant development potential and a considerable level of uncertainty related to future price and performance.

The annual specific production (capacity factor/full load hours) is expected to continue to increase; this is illustrated in figure 17. The increase in production is mainly expected to be due to lower specific power, but also increased hub heights, especially in the regions with low wind, and improvement in efficiency within the different components is expected to contribute to the increase in production.

The predictions of cost reductions are made using the learning curve principle. Learning curves expresses the idea that each time a unit of a particular technology is produced, some learning accumulates which leads to cheaper production of the next unit of that technology. Therefore a reduction in investment cost is expected. Research and development is also expected to influence the cost and efficiency.

According to the report "Renewable Power generation cost in 2014 Electricity", IRENA 2014 [17] the cost of onshore wind turbines has reduced by 4-25% from 2010 to 2014, with large geographical variations. At the same time, the cumulative installed capacity (CIC) increased by 80%. The largest cost reductions have been realized in China and India. Hence, the learning rate for the investment cost for onshore wind turbines is set to approximately 10%. In addition, it is assumed that for each of the periods 2015-2020, 2020-2030 and 2030-2050 the cumulative installed capacity (CIC) will be almost doubled. The resulting development in cost is illustrated in figure 16. At the same time it is assumed that the production (FLH) will increase due to a reduction in the specific power and technical improvements. It is expected that the production (FLH) increase 1.5 % from 2015 to 2020 and from 2020-2030 and 3% from 2030-2050.

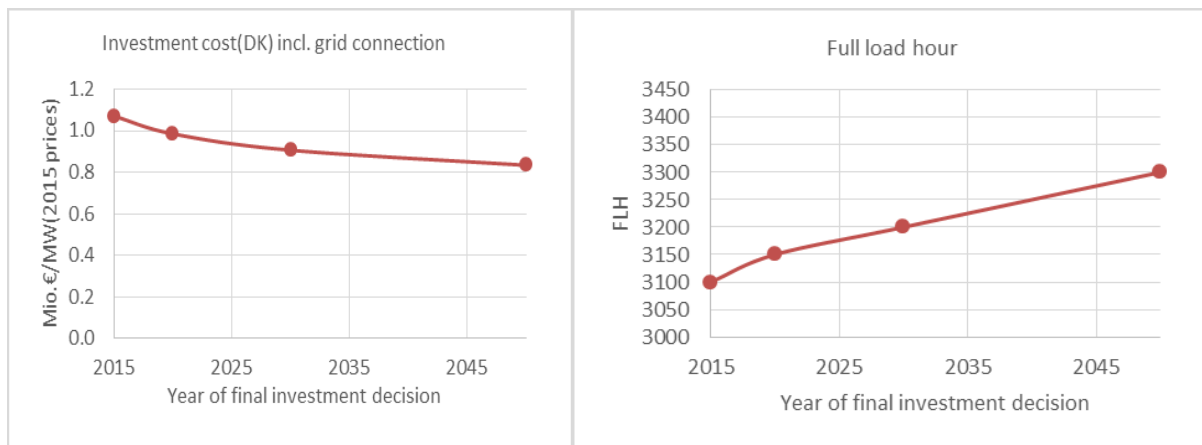

Figure 17: Expected development in investment costs and in production (full load hours (FLH)) for on shore wind turbines located in DK.

The predicted development in costs and full load hours leads to a decrease in levelized cost for produced electricity (LCOE) of approximately 11% in each period, resulting in approximately 30% lower LCOE in 2050 than in 2015.

This is in accordance with development the same report [17] the weighted LCOE has fallen 7-12 % from 2010 to 2014. At the same time, the cumulative installed capacity (CIC) increased by 80%. This is equivalent to a learning rate for LCOE in the range of 9-15%.

Uncertainty

As mentioned before the onshore wind technology is quite mature. However, due to improvements in technology and cost reductions, the prediction of future reductions in cost of energy is affected by some uncertainty. Especially it must be noted regarding cost development that many other factors than learning curves can affect the cost development, such as the market situation, costs of rare earth minerals, iron, cobber etc. The development in full load hours is affected by the geographic locations of the majority of the turbines to be installed, and it can be increased considerably if larger total heights will be accepted in future.

Future demands, onshore

In the future it could be expected that the onshore wind turbines will be met with

- Higher environmental protection demands like noise or reduced visibility of aviation light marking or less visibility in general (colouring).
- More demands on participation in grid regulation.

Additional remarks

Recently, the technical lifetime of a wind turbine has been assumed to be 20 years. Recent investigations and real-life experiences indicate longer technical lifetimes [18, 19, 20]. For turbines installed in the coming years lifetimes of 25 years are expected. In the longer term (2030-2050) lifetimes of up to 30 years could be expected.

Domestic wind turbines (microwind or small-wind turbines)

Domestic wind turbines are micro-wind or small-wind turbines with a capacity up to 25 kW. According to the regulation in Denmark domestic wind turbines (up to 25 kW) must be located in close proximity of a house (within 20 m from building) [21], and must follow the same demands for noise as large turbines [22].

The capacity factor of small wind turbine varies a lot dependent on the local conditions. The turbines are often located close to buildings and trees, which will reduce the annual production from the turbines. The specific power will as for the larger turbines have an impact on the capacity factor and so have the relative low hub height. An average capacity factor of 18% (approximately 1600 full load hours) is assumed in this study. There are no public available statistics for confirmation of this though, while domestic turbines only report sold power whereas in-house consumption directly from turbine is not registered.

Data sheets

Technology	Large wind turbines on land										
	Year of final investment decision	2015	2020	2030	2050	Uncertainty (2020)		Uncertainty (2050)		Note	Ref
Energy/technical data						Lower	Upper	Lower	Upper		
Generating capacity for one unit (MW)	3.5	3.5	4	5	2.0	6.0	1.5	8.0	A1	3	
Average annual full-load hours	3,100	3,150	3,200	3,300	2,000	4,000	2,000	4,500	A, L	3	
Forced outage (%)	3.0%	2.5%	2.0%	1.5%	1.0%	5.0%	1.0%	5.0%	B	4	
Planned outage (%)	0.3%	0.3%	0.3%	0.3%	0.1%	0.5%	0.1%	0.5%	C	4	
Technical lifetime (years)	25	27	30	30	25	35	25	40	D	14	
Construction time (years)	1.5	1.5	1.5	1.5	1	3	1	3	E	4	
Space requirement (1000m ² /MW)	---	---	---	---	---	---	---	---	F		
Regulation ability											
Primary regulation (% per 30 seconds)									G		
Secondary regulation (% per minute)									G		
Financial data											
Nominal investment (M€/MW) incl grid connection	1.07	0.99	0.91	0.83	0.9	1.1	0.7	1.0	H	16, 2, 4	
Nominal investment (M€/MW) excl. grid connection (5% of nom. Investment)	1.02	0.94	0.86	0.79	0.8	1.0	0.6	0.9	I, M	16, 2, 4	
- of which equipment	75%	75%	75%	75%	70%	80%	70%	80%		4	
- of which installation	25%	25%	25%	25%	20%	30%	20%	30%		4	
Fixed O&M (€/MW/year)	25,600	23,900	22,300	21,200	21,510	26,290	16,960	25,440	J,N		
Variable O&M (€/MWh)	2.8	2.5	2.3	2.1	2.3	2.8	1.7	2.5	J,N	4, 15, 18	
Technology specific data											
Rotor diameter	120	120	130	150	90	130	100	150	K	4	
Hub height	90	90	100	110	85	120	85	150		4	
Specific power (W/m ²)	309	309	301	283	270	350	250	350			
Average capacity factor	37%	37%	38%	39%	23%	46%	23%	51%		4	
Average availability (%)	97%	97%	98%	98%	99%	95%	99%	95%		4	

Notes:

- A1 The capacity is set to 3.5 MW in 2015 and 2020 based on data of current wind turbines (Stamdataregisteret) and under the anticipation that the maximum height will not exceed 150m before 2020. From 2030 a slight increase in generator size, and hub height is assumed.
- A The full load hours (annual production (MWh) per installed power (MW)) depending on the actual location of the wind farm, wake losses and technological characteristics of the individual turbine. The value is an average for the expected locations of the wind farms. FLH also depends on wake losses, noise reduction and technological characteristics of the individual turbine. The level for 2015 and 2020 is based on data for existing onshore turbines of the same configuration (Stamdataregisteret) and recent prospects for onshore projects published in relation to Køberetsordningen. For 2030 and 2050 a slight increase is assumed based on decrease in specific power and increase in hub height.
- B Modern turbines has typically higher forced outage than older smaller turbines had when they were newer due to more complex technology.
- C Planned outage is typically 1-2 service visits a year, with a maximum duration of one work day, but there can also be planned outage due to shadow flicker stop or sector management (protect turbines at given wind speeds and directions, where they are dense spaced).

- D The life time depends on the wind conditions; average annual speed and turbulence, relative to the design class of the turbine
- E The construction time is the periode from FID to commissioning. But from first "dig" to turbines are in operation less than ½ a year is needed for smaller wind farms (clusters), where the similar periode for larger wind farms will be longer. The planning time from idea to construction starts will typically be 2-3 years, but can be essentially more if permitting problems occur.
- F An area of around 50 m x 50 m is needed for a modern wind turbine. Another way of defining the "area use" could be the noise zone, which ranges up to 600-800 m from the wind turbine in worst case.
- G Wind turbines can be downward regulated within very short time and can therefore (if the wind is blowing) be used in both the primary and secondary downward regulation.
- H 2015 Investment cost based on a number of recent prospects for projects published in relation to Køberetsordningen. The price is excl. land rent, buy out of existing older turbines and possible buy out of settlements within wind farm area which are highly variable costs.
- I The grid connection is socialized in Denmark and can be subtracted from the given nominal investment seen from the project owner
- J 75 % of the total yearly O&M costs are assumed to be fixed cost and 25 % are assumed to be variable cost.
- K Currently only turbines up to 150 m total height is installed commercially in Denmark because of strict demands to higher turbines. No change in the national regulation is assumed until after 2020. Some test sites allow for larger turbines. Aboard e.g. in Germany windmills with at total higher of 200 m is installed today.
- L It is expected that the production (FLH) increase 1.5 % from 2015 to 2020 and 2020-2030 and 3% in from 2030-2050
- M It is predicted that the investment cost for on shore turbines will be reduced 8% in each period; 2015-2020, 2020-2030 and 2030-2050.
- N It is predicted that the cost of O&M for on shore turbines will be reduced 8% in each period; 2015-2020, 2020-2030 and 2030-2050.

Technology	Small wind turbines, grid connected (< 25 kW)									
	2015	2020	2030	2050	Uncertainty (2020)		Uncertainty (2050)		Note	Ref
Energy/technical data					Lower	Upper	Lower	Upper		
Generating capacity for one unit (MW)	< 0,025				0.005	0.025	0.005	0.025		
Average annual full-load hours	1,600	1,600	1,600	1,600	1,000	2,300	1,000	2,300	A,J	
Forced outage (%)	3%	3%	3%	3%	2%	10%	2%	10%		
Planned outage (%)	0.3%	0.3%	0.3%	0.3%	0.1%	0.5%	0.1%	0.5%	B	
Technical lifetime (years)	20	20	20	20	---	---	---	---		
Construction time (years)	1	1	1	1	0.5	1.5	0.5	1.5		
Space requirement (1000m2/MW)	0.8	0.8	0.8	0.8	---	---	---	---	C	
Regulation ability										
Primary regulation (% per 30 seconds)	---	---	---	---	---	---	---	---	D	
Secondary regulation (% per minute)	---	---	---	---	---	---	---	---	D	
Financial data										
Nominal investment (M€/MW) incl grid connection	4.0	3.8	3.6	3.4	3.0	6.0	3.0	6.0	E/F	
Nominal investment (M€/MW) excl. grid connection (5% of nom. Investment)	90%	90%	90%	90%	85%	95%	85%	95%	E/F	
- of which equipment	10%	10%	10%	10%	15%	5%	15%	5%	E/F	
- of which installation	100,000	95,000	90,000	85,000	---	---	---	---	G	
Fixed O&M (€/MW/year)	---	---	---	---	---	---	---	---		
Variable O&M (€/MWh)	4.0	3.8	3.6	3.4	3.0	6.0	3.0	6.0	E/F	
Technology specific data										

Rotor diameter	8	8	8	8	4	14	4	14	H	
Hub height	18	18	18	18	14	18	14	18	H	
Fixed O&M (€/unit)	540	540	540	540	350	700	350	700	E/F	

Notes:

- A The annual production is very sensitive to conditions at the actual site. Values outside the range is observed.
- B The maintenance normally consists of 1 -2 annual service visits.
- C An area of around 5 m x 5 m is needed for at small wind turbine. The real "area use" is the noise zone, which ranges up to 100 m from the wind turbine in worst case.
- D Not considered relevant for small domestic turbines.
- E Based on information from manufacturers and resellers. The
- F The prices depends significantly on turbine size (5 kW - 6 M€/MW; 10 kW - 4 M€/MW ; 25 kW - 3 M€/MW)
- G The service cost is assumed fixed to 100€/kW/y.
- H Domestic turbines have a maximum total height of 25 m according to Danish regulations.
- J No development in the capacity factor is expected, because no changing in the size limitation (legislation) is expected. And because location is crucial and one must expect the turbines is put up at the best positions already. But change in legislation i

References

- [1] Information's from expert workshop held by DEA 27-4-2015.
- [2] DTU International Energy Report - Wind Energy, DTU, 2014.
- [3] Master data register of wind turbines at end of December 2014, Danish Energy Agency, 2015.
- [4] Nielsen, P. et. al., Vindmøllers økonomi EUDP projekt 33033-0196, 2010.
- [5] Fixed Speed and Variable-Slip Wind turbines Providing Spinning reserves to the Grid, NREL, 2013.
- [6] Sundhedsundersøgelsen [Online]. Available: <http://vindinfo.dk/sundhedsundersogelse.aspx>.
- [7] M. e. al, Wind Turbines and Health, Journal of Occupational and Environmental Medicine, årg. 56, nr. 11, November 2014.
- [8] Vindkraftens påverkan på fåglar och fladdermöss, Naturvårdsverket, 2011.
- [9] Life Cycle Assessment of Electricity Production from an onshore V112-3.3 MW Wind Plant, June 2014, Vestas Wind Systems A/S.
- [10] Environmental Product Decalaration - SWT-3.2-133, siemens.dk/wind, 2014.
- [11] S. Krohn, The Energy balance of modern turbines, December 1997.
- [12] Karl R. Haapala and Preedanood Prempreeda, Comparative life cycle assessment of 2.0 MW wind turbines, Oregon State University, USA, 2014.
- [13] Increasing the Owner's Value of Wind Power Plants in Energy Systems with Karge
- [14] Information from Energinet.dk based on analyses of resent installed projects (2013-14), published under "Købsretsordningen", 2015.
- [15] Når all-inclusive service alligevel ikke dækker alt, Naturlig Energi, nov. 2014.
- [16] Schwabe, P., Lensink, S. & Hand, M., IEA Wind Task 26: Multi-national case study of the financial cost of wind energy, 2011.
- [17] Renewable Power Generation Cost in 2014 Electricity, Irena, 2014.
- [18] Hvor længe holder en mølle, Naturlig Energi, januar 2012.
- [19] Green, Staffell, How does wind farm performance decline with age?, Renewable Energy 66, 2014.

- [20] Vindmøller lever længere end forventet, November 2010. [Online]. Available: <http://www.ing.dk/artikel/vindmoller-lever-laengere-end-forventet-114251>.
- [21] Vejledningsnotat om planlovens regler ved opstilling af husstandsmøller, Naturstyrelsen, 2012.
- [22] Bekendtgørelse om støj fra vindmøller - BEK nr. 1284 af 15-12-2011, Retsinfo, 2011.
- [23] Energifaften af 22. marts 2012, <http://www.efkm.dk/energi-forsynings-klimapolitik/dansk-energi-forsynings-klimapolitik/energifaften>, 2012.
- [24] Minivindmøller i København, Ea Energy Analysis for Copenhagen Municipality, November 2009.

21 Wind Turbines, Offshore

Contact information:

Danish Energy Agency: Rikke Næraa, rin@ens.dk

Author: Mads V. Sørensen / Per Nielsen (EMD)

Publication date

August 2016

Amendments after publication date

Date	Ref.	Description
June 17	Prediction of cost in 2015 and 2020 Prediction of cost from 2020 to 2050 Data sheet	Financial data (Investment cost and O&M) updated

Note to Amendments June 2017:

The winning price in the tenders for the offshore wind farms in Denmark has decreased substantially from 2012 to 2016. The same trend has been seen in e.g. the Netherlands and Great Britain. The reduction in prices is substantially larger than what can be explained by the cost reduction predicted (in the Technology Catalog). Therefore, the financial data for offshore wind has been updated (June 2017). Changes are made in the sections “*Prediction of costs in 2015*” and in the datasheet.

The update comprises investment costs (CAPEX) and operating & maintenance costs (OPEX), i.e. financial parameters. In terms of data for the more technical parameters such as mill size, full load hours, lifetime and the like existing data are still considered valid.

There are several reasons for the reduction in the winning bids. The costs of the wind turbine technology itself, as well as for installation, operation and maintenance have fallen sharply in recent years. In general, more experience has been gained in this area, making the collaboration between the different players on the market more efficient. Moreover, there are better opportunities for optimizing project plans and the volume of the offshore wind market. In addition, interest rates are low and technological and economic risks are assessed lower by investors, therefore low returns are accepted and competition has been increasing. Expectations for the electricity price after expiry of the grant period and other possible income from e.g. certificates of origin also affect the bid price.

Qualitative description

Brief technology description

For a detailed technical description see the previous chapter on wind turbines, onshore.

The basic operating principles of offshore wind turbines are the same as for onshore turbines, although modifications are required to make the turbines suitable for deployment offshore. The corrosive offshore environment resulting from the high levels of salt and moisture in the air leads to additional requirements for electrical and mechanical components. Since the world's first offshore wind project at Vindeby in Denmark, offshore turbines have been equipped with air conditioning systems to protect the sensitive electronics inside the units, and with North Sea-grade protective paint to protect the external steel structures.

Foundations for offshore turbines are subject to more complex load conditions than onshore foundations. They must be designed to survive the harsh marine environment and the impact of large waves and ice. These factors and the cost of installation mean that they are more expensive than onshore foundations for turbines of similar size.

Until now, offshore wind farms have been installed on four different types of foundation: monopile, gravity, jacket and tripod structures. Today, monopiles and jackets are the most common foundation types. The choice of which foundation type to use depends on the local sea-bed conditions and the water depth.

Technological innovations such as suction bucket foundations and floating foundations are being investigated and may have the potential to reduce the overall cost in the future. Suction bucket foundations are mainly suitable when the sea bed is sand, but have the advantage of smaller material consumption and lower decommissioning cost. Floating constructions can be designed to be well suited for large serial production, and they are the only solution for deep waters. These technologies are not currently deployed on a commercial basis.

Offshore wind farms are typically built with large turbines in considerable numbers. The most recent offshore wind farms built or under construction in Denmark have capacities of 200-400 MW. Projects of up to 600 MW are being planned in Danish waters. In UK, Netherlands and German waters offshore wind farms of several thousand MW are being developed.

Offshore wind turbines have built-in transformers delivering 33 kV to the array cable system in the wind farm. In traditional offshore wind farms the array cables are connected to a transformer station in the wind farm. Here the voltage is transformed to 150 kV or 220 kV for export to the onshore grid. In nearshore wind farms the array cables are often connected to an onshore transformer station.

66 kV turbine transformers, switchgear and cables are becoming commercially available, and the wind farm voltage level of new projects is generally expected to be raised from 33 kV to 66 kV. The higher voltage level will reduce cable losses and the total lifecycle costs and thereby reduce the cost of energy.

Offshore wind power projects include both traditional offshore projects and nearshore projects. In this publication near-shore wind farms are defined as projects having grid connection at the wind farm voltage level, i.e. connecting to an onshore transformer station.

The offshore wind resource increases with distance to the shore (figure 1) and as a result wind farms far from the shore will generally have higher capacity factors than nearshore wind farms. However, due to the simplified

grid arrangement with no offshore substation, and due to shallow waters and shorter distances to service hubs, nearshore wind farms have lower cost levels for both investment and O&M.

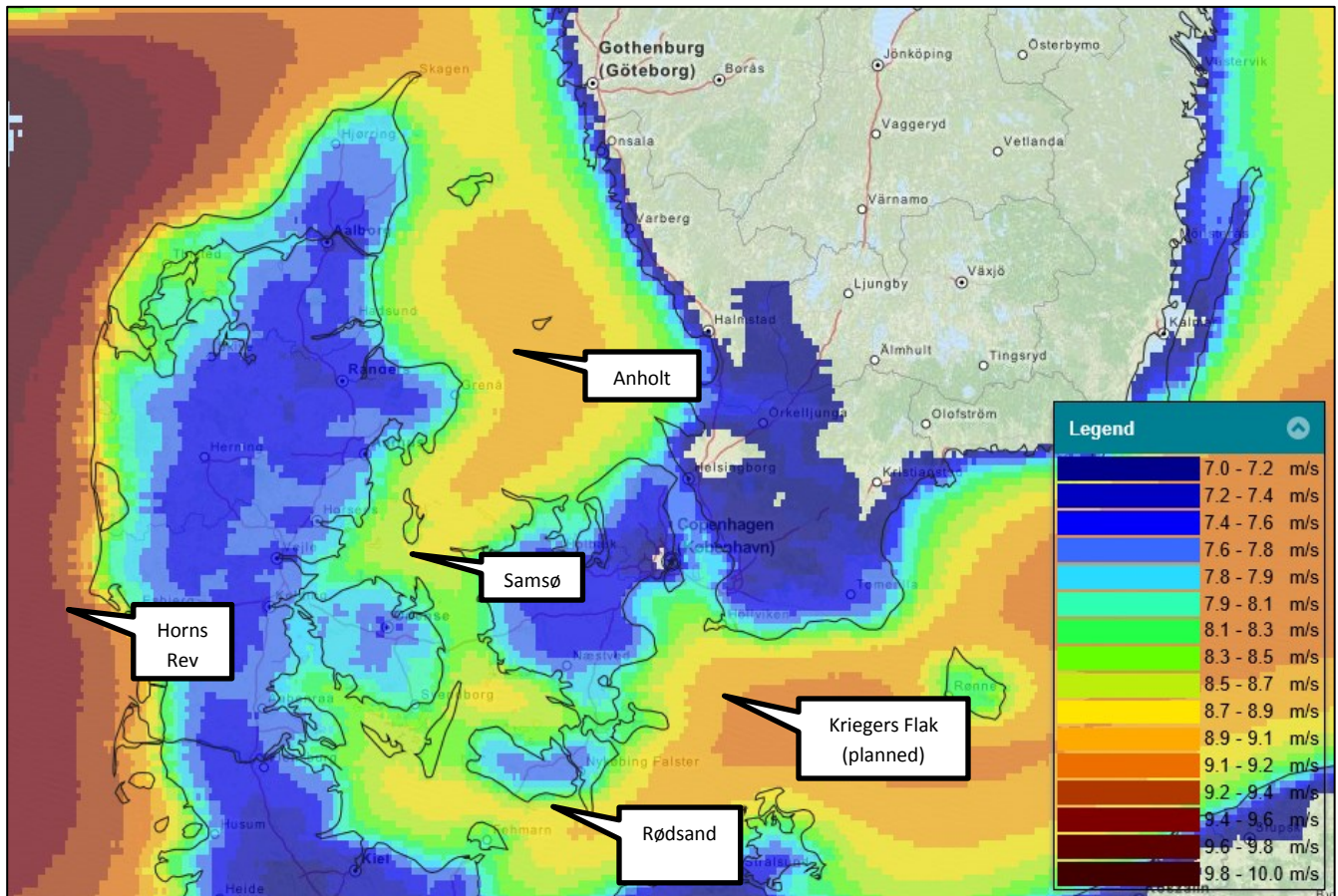

Figure 1 Wind resource map for Denmark (height above terrain/sea level: 75 m) based on EMD-ConWx meso scale modelled wind data [1]

The wind resource map of Denmark shows hub-height annual average wind speeds of 9-10 m/s in the Horns rev area, around 9 m/s in areas around Anholt and Kriegers Flak and 8-9 m/s in the Rødsand and Samsø areas. Due to the low surface roughness, the variation in wind speed with height is small for offshore locations; the increase in wind speed from 50m to 100m height is around 8%, for comparison the increase in wind speed from 50m to 100m height is around 20% for typical inland locations.

Input

Input is wind.

Minimum wind speed: 3-5 m/s.

Rated power generation reached around 12 m/s wind speed.

Cut-out or transition to reduced power operation at wind speed: 25- 30 m/s.

Most turbine manufacturers apply a soft cut-out for high wind speeds (indicated with dashed red curve in figure 2) resulting in a final cut-out wind speed around 30 m/s [2, 3].

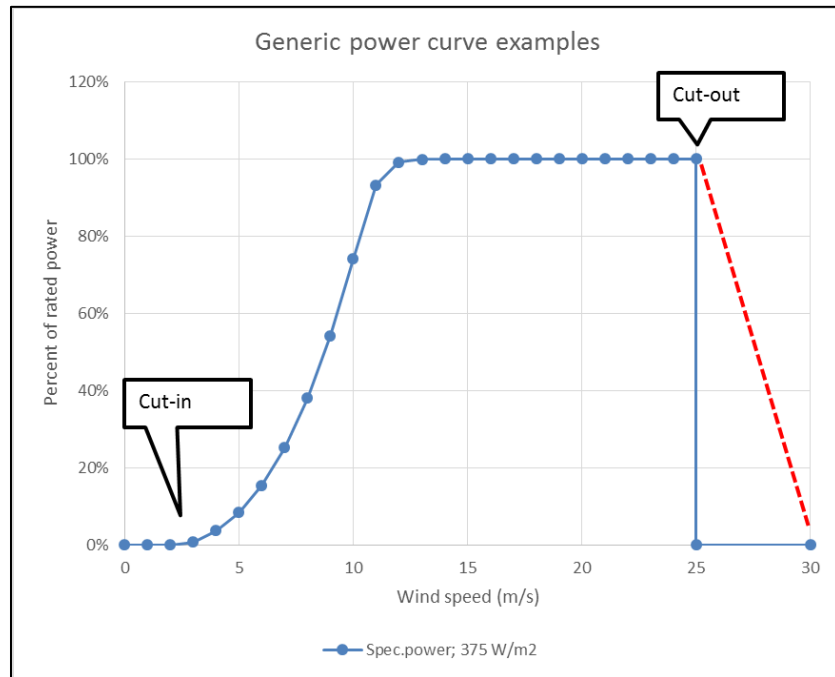

Figure 2 Power curve example [4]. Specific power values refer to e.g. 7 MW with 154 m rotor diameter.

Output

The output is electricity.

Modern offshore turbines located in Denmark have capacity factors of the order of 50%, corresponding to 4400 full load hours. A typical duration curve for a wind farm in the North Sea is presented in figure 3 below.

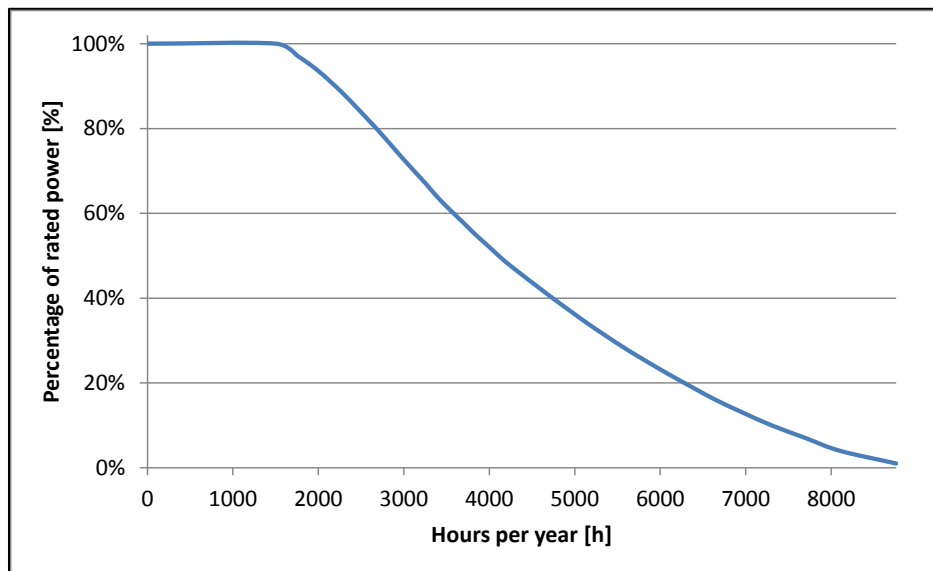

Figure 3 Example of a duration curve for a North Sea offshore wind farm [5]

Typical capacities

In 2015 the average capacity of offshore turbines under construction in Europe was 4.2 MW, ranging from 3 - 6 MW [6]. Turbine capacities of offshore wind turbines are expected to increase in the near term, with the introduction of new turbines with rated powers in the range of 6 - 8 MW. In Denmark a large jump in turbine capacity happens between the newest offshore wind farm Anholt and the next planned Horns Rev 3, with rated power increasing from 3.6 MW to 8 MW. Rotor diameters are expected to increase as well, maintaining a specific power of 300-400 W/m² [7]. However, specific power is expected to increase slightly in the near term in Denmark because of the large increase in capacity as seen for MHI Vestas' V164-8.0 MW and Siemens Wind Powers' SWT-6.0-154 and SWT-7.0-154. From 2020 and onwards 10+ MW turbines are expected to become commercially available, but it is not expected that such large turbines will be standard in Denmark before after 2030.

Towards 2020, the size of offshore wind farms in Europe (excl. Denmark) is expected to be in a range of 300 - 1200 MW. For some new projects the conditions will become more demanding than now: deeper waters (40- 50 m) as well as larger distances to shore (100+ km).

In Denmark, the current planning comprises two offshore wind farms (Kriegers Flak (600 MW) and Horns Rev 3 (400 MW)) and six nearshore projects (350 MW in total, maximum 200 MW per site).

The size of offshore wind farm erected in Denmark in medium term is expected to be from 200 - 600 MW.

Wind resource and capacity factors

One of the major drivers for developing wind farms offshore rather than onshore is the better wind resource, which can justify some of the additional investment and O&M costs. Offshore wind farms installed in Denmark

since 2009 have a weighted average capacity factor of 48%. For comparison, onshore wind turbines installed in Denmark since 2010 have an average capacity factor of 33%.

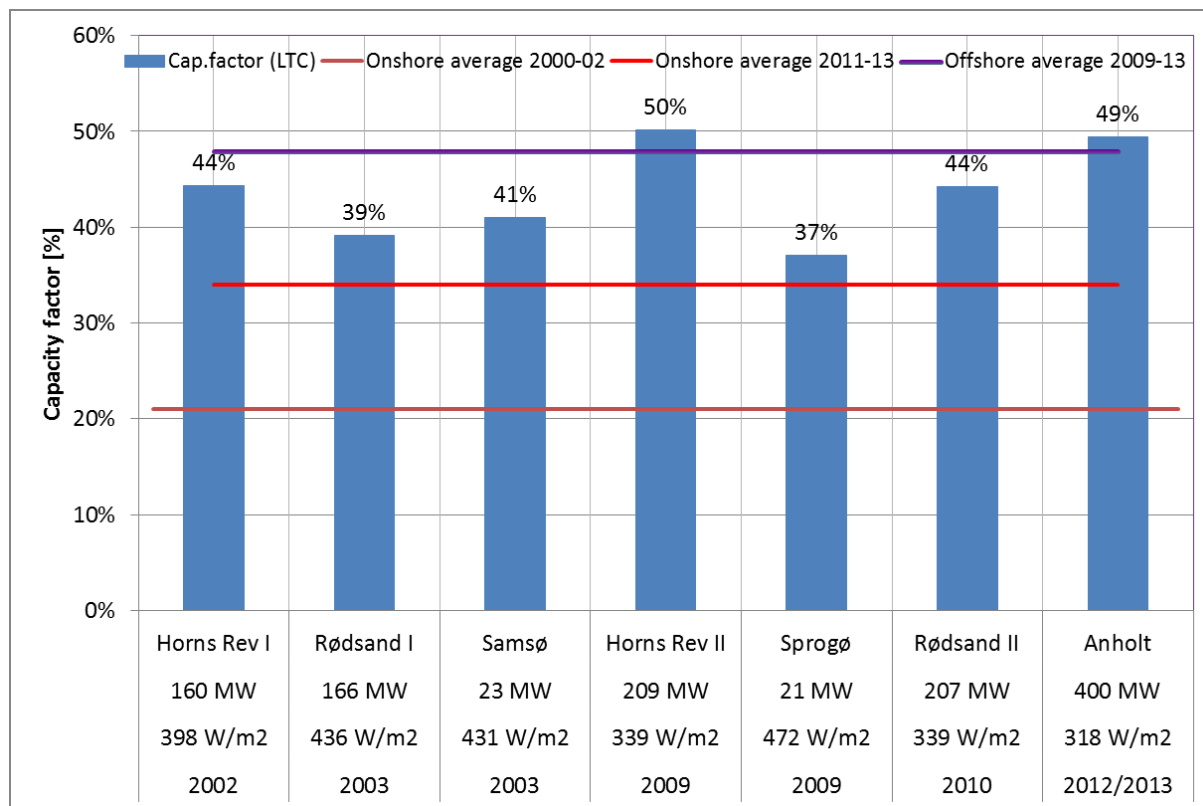

Figure 4: Long term corrected (LTC) capacity factors for five large offshore wind farms (>150 MW) and two smaller offshore wind farms located nearshore in Denmark. For comparison is shown the average capacity factor for onshore turbines installed 2000-02 and 2011-13 based on measured 2014 performance (which was a normal wind year) [8]. Year of commission shown in graph.

There is a significant variation in capacity factors between the different projects (figure 4). This is caused by a combination of differences in the turbine technologies, including different specific power values, and in the wind resources.

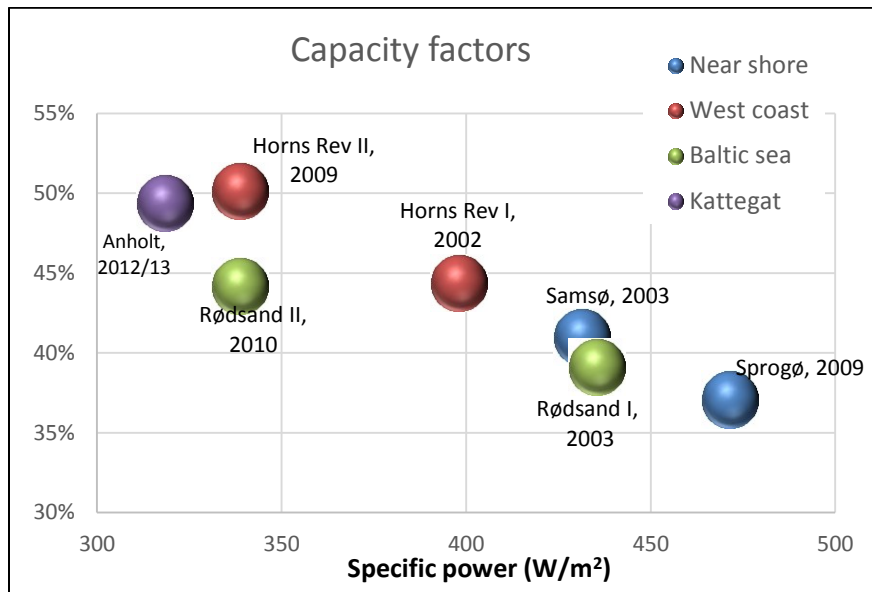

Figure 5: Capacity Factor shown as function of the Specific Power (W/m^2) for Danish Offshore wind turbine projects. The 3 most left are the latest projects.

Figure 5 shows the capacity factor as a function of the specific power, with locations represented by the coloring. Both the location and the specific power are key drivers of the capacity factor. Horns Rev I and Horns Rev II have similar wind resource, but different specific power and therefore different capacity factors. Likewise Rødsand I and Rødsand II have similar wind resource, but different specific power and therefore different capacity factors.

Regulation abilities and power system services

Offshore wind turbines have similar regulation and ancillary service capabilities to onshore turbines. See the descriptions in the chapter about onshore wind turbine.

Offshore wind turbines have a disadvantage for regulation of voltage and reactive power in the main power grid, because of the large distances between the wind farm and the point of connection to the power grid. A larger distance will result in an increased impedance and loss. An offshore wind farm will be able to compensate for reactive power created by itself, however their contribution to further compensation of reactive power in the main grid is limited depending on the distance to point of connection. Onshore wind turbines, which in general are closer to the grid, have better possibilities for contributing to regulation of voltage and reactive power.

Advantages/disadvantages

Offshore wind turbines have similar general advantages and disadvantages to onshore turbines. See the chapter “Wind turbines onshore”.

The major advantages of offshore wind turbines, relative to onshore wind turbines, are the better wind resources offshore, the reduction of the visual and noise impacts from turbines which has become a major barrier for onshore deployment, and the possibility of building much larger wind farms than onshore.

There are, however, major logistical challenges associated with building wind turbines offshore. These challenges have resulted in high capital costs for developing offshore wind farms.

Electricity from offshore wind production may become an export product in the future, as Denmark has relatively more space for offshore development than most European countries.

Environment

Some disturbance to sea-life must be anticipated during the construction phase for offshore wind turbines.

Before, during and after the construction of two Danish wind farms Horns Rev I and Rødsand I, comprehensive monitoring programmes were launched to investigate and document the environmental impact of these two wind farms [9]. The monitoring programmes showed that, under the right conditions, large wind farms pose low risks to birds, mammals and fish. Species diversity even tends to increase due to the increase in habitat heterogeneity resulting from the foundations, which act as miniature reefs.

Consequently, the results from the monitoring programmes demonstrated that it is possible to establish offshore wind farms in a way, which is environmentally sustainable and which causes negligible damage to the marine environment.

Research and development perspectives

Besides the R&D potential described in the chapter “Wind turbines onshore”, offshore technology development is expected to include [10, 11].

- Further upscaling of wind turbines
- New foundation types suitable for genuine industrialization
- Development of 66kV electrical wind farm systems as alternative to present 33 kV.
- Development of compact offshore substations, including high-voltage direct current (HVDC) converter stations and cables. HVDC equipment is available today.
- Improvement of design methods in planning and operation phase, e.g. reduction of wake losses, O&M costs by e.g. improved control strategies, more optimized tower/foundation structure by integrated design.
- Logistic issues, e.g. more dedicated vessels in installation and maintenance phase.
- Improved methods for handling of different sea bed conditions, lowering foundation costs.
- Improved monitoring in operational phase for lowering availability losses and securing optimal operation.

At the present time the pace of product development and competition is high. Consequently, projects are often planned and developed on the basis of turbines that are not yet in serial production.

Examples of best available technology

The latest major offshore wind farm installed in Denmark is the Anholt offshore wind farm. It consists of 111 Siemens Wind Power turbines (SWT-3.6-120), each with 3.6 MW capacity, resulting in a total installed capacity of 400 MW. The wind turbine has 120 m rotor diameter, leading to a specific power of 318 W/m². The SWT-3.6-120 has by far been the most common offshore wind turbine the last few years, however larger turbines are currently entering the market as for instance Siemens Wind Powers' SWT-7.0-154 and MHI Vestas' V164-8.0 MW [6].

Currently Siemens Wind Power offers 3.6 MW and 4 MW geared turbines and 6 MW and 7 MW direct drive turbines. MHI Vestas offers an 8.0 MW geared turbine, and Senvion, Areva/Gamesa (Adwen) and Alstom are all offering turbines in the 6-8 MW range [10]. The 8.0 MW MHI Vestas turbines have been selected for the Horns Rev III project, which is expected to be commissioned in 2018-19.

Prediction of performance and cost

Breakdown of costs

A breakdown of costs of a typical offshore wind farm reveals that the wind turbine represents a smaller portion of the total investment, when compared to onshore projects. This portion gets even smaller, when the project is far from shore and in deep waters. In Denmark, where wind farms are typically awarded by a tender process, the cost of substation, export cable and the environmental impact assessment are not financed by the project developer for offshore projects, but financed by the electricity consumers. The array cables connecting the turbines with the substation are however covered by the developer. Furthermore, offshore wind farms built under the open-door¹³ application scheme must carry the costs of grid connection from the wind turbine to point of connection to national grid (e.g. array cable, substation and export cable) and environmental impact assessments. These costs are included in figure 6 in order to provide a more accurate picture of the total costs associated with developing offshore wind farms in Denmark.

¹³ In the open-door procedure, the project developer takes the initiative to establish an offshore wind farm of a chosen size in a specific area. This is done by submitting an unsolicited application for a license to carry out preliminary investigations in the given area.

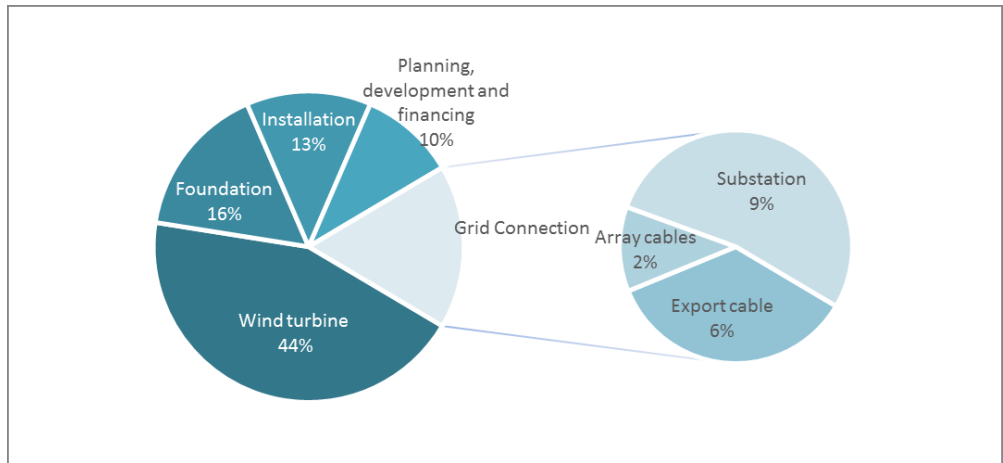

Figure 6: Breakdown of costs for offshore wind farms (Renewable Energy Technologies: Cost Analysis Series, 2012). The cost of environmental assessment is a part of the Planning & development and financing cost component

Cost dependence of water depth, distance to shore and wind farm size

Table 1 shows the costs of foundations (material + installation) for different water depths. The costs are estimated by two different studies, dated 2007 and 2014, respectively [12, 13]. It should be noted that the Study 2 is Siemens price-forecast and not realized results.

Water depth (m)	Foundation cost (M€/MW)	
	Study 1	Study 2
10	0.48	
20	0.74	0.42
30	1.18	0.67
40	1.88	0.84
50	---	1.05

Table 1: Foundation costs (monopile foundations, 2015 prices, 50m is a jacket construction) at different water depths, study 1 (from 2007) [14], Study 2 (from 2014) [13] based on recent price-forecast from Siemens Wind Power.

Figure 7, figure 8 and figure 9 show the total investments cost for offshore wind farms (including grid connection costs) as a function of water depth, distance to shore, and farm size, respectively. The figures are based on 35 projects commissioned from 2002 to 2014 [15, 16].

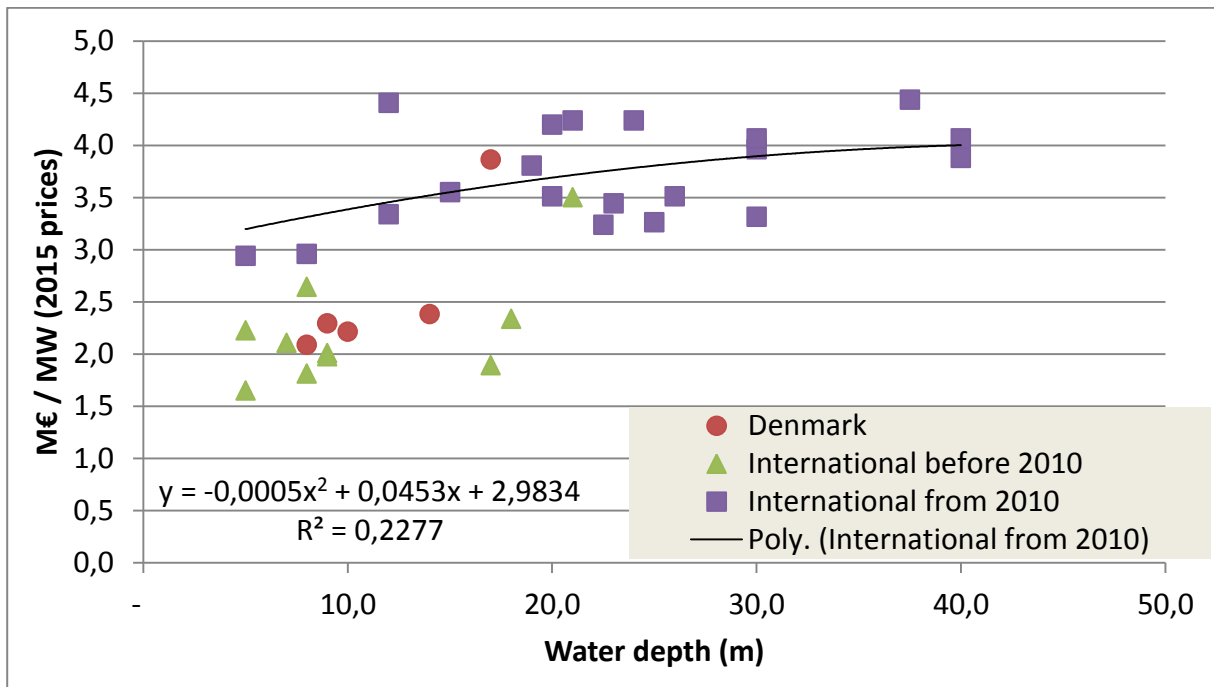

Figure 7: Cost plotted against water depth for 35 realized offshore projects in DK, UK, DE and SE from 2002 to 2014.

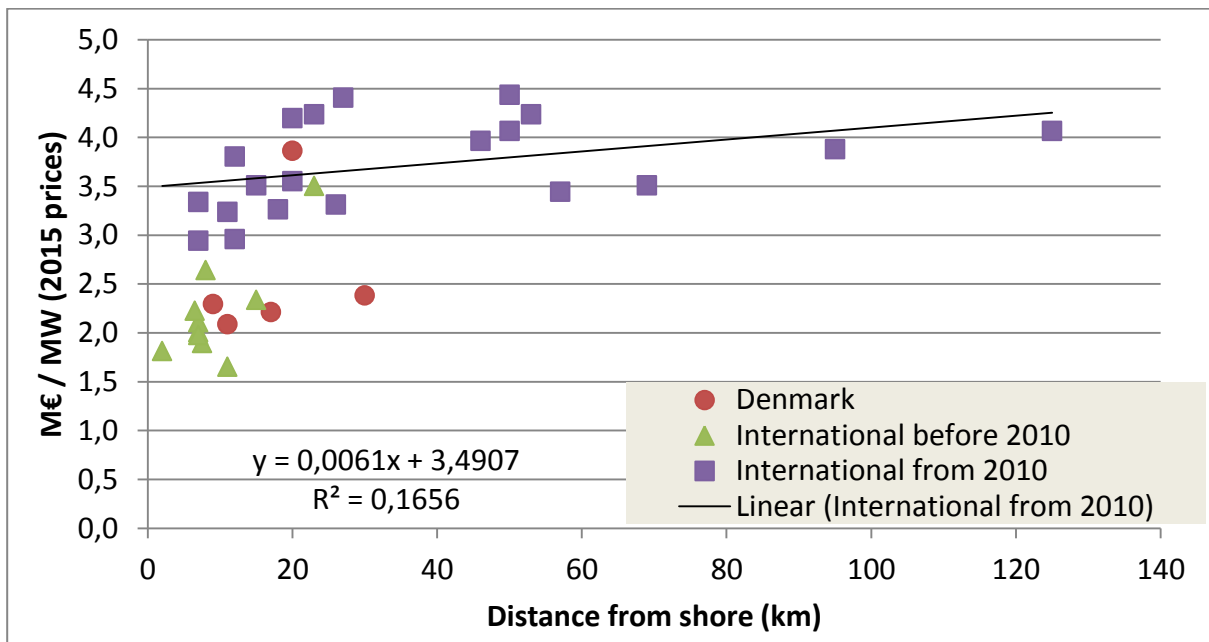

Figure 8: Cost plotted against distance to shore for 35 realized offshore projects in DK, UK, DE and SE from 2002 to 2014.

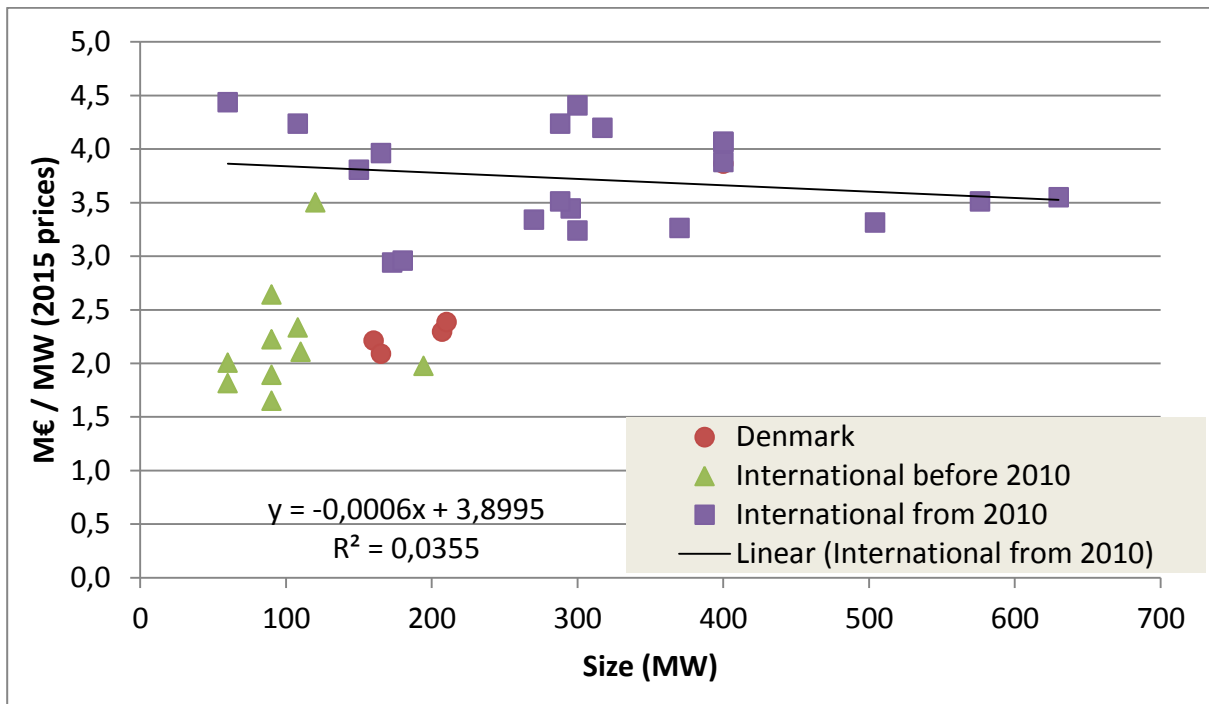

Figure 9: Cost plotted against farm size for 35 realized offshore projects in DK, UK, DE and SE from 2002 to 2014.

The trend lines for international projects commissioned from 2010 to 2014 represent the overall cost sensitivities to water depth, distance to shore, and wind farm size. It should be noted, however, that the statistical significance of the trend lines are relatively poor due to the multi-variable cost drivers and project-to-project variations.

The capacity factor is high in Denmark and is expected to increase more than in comparable countries. Especially German offshore wind farms are expected to experience wake effects because they will be located densely due to heavy deployment and scarcity of wind sites, whereas Danish sites are more abundant in the Northern Sea compared to the size of the country [17].

The offshore wind farm capacity factors are expected to increase, mainly due to larger hub heights with associated higher average wind speeds and lower specific power. Wind sites are expected to be of the same average quality as the existing offshore wind sites with respect to wind speed, water depth, distance to nearest harbor etc. until after 2030. There after sites in the North Sea further from shore are expected to be utilized which are more expensive but also have higher average wind speeds. Finally, technological improvements such as step up to 66 kV connections to substations are expected to contribute to increased capacity factor. It is predicted that the overall increase in capacity factor will be higher for offshore than for nearshore.

Nearshore wind turbines are hard to estimate in the far future because the amount of feasible sites in Denmark is limited and therefore they are expected to be fully deployed before 2050. Alternatively, nearshore wind farms will be located further from the shore and will be located at sites currently expected to be offshore sites.

In the projections we assume that future nearshore wind sites will be of the same kind as the nearshore sites tendered in 2016 in terms of distance to shore, size, wind speed and water depth. Therefore, there will be only few sites. These sites are expected to be cheaper but also to have lower wind speeds than offshore sites.

The project lifetime is expected to increase from 25 years in 2015 to 30 years in 2030 due to more mature technologies and a dedicated focus on extended life.

Prediction of cost in 2015 and 2020

In 2015 and 2016, five tenders have been settled for offshore wind farms in Denmark and in the Netherlands, where conditions are considered to be comparable. Data from these five projects has contributed to determine investment costs (CAPEX) and costs of operation and maintenance (OPEX) for the period 2015 to 2020. An overview of wind farms which have been put out to tender in 2015 and 2016 is shown in Table 2.

Project	Country	Farm size [MW]	Year(FID)	Winning
Horns Rev 3 (HR3)	DK	406,7	2015	Vattenfall
Kriegers Flak (KF)	DK	600	2018	Vattenfall
Borssele 1+2 (BS1+2)	NL	Approx. 700	2017	DONG
Borssele 3+4 (BS3+4)	NL	Approx. 700	2020	Shell
Near shore (Vesterhav North and South)	DK	350	2017/2018	Vattenfall

Table 2: Overview of the winning bids for offshore wind farm in 2015 og 2016 in Denmark and the Netherlands.

CAPEX

Vattenfall has announced that they expect to invest around 1 billion € in HR3 , which corresponds to approx. 2.46 million € per MW (2015 prices). Furthermore Vattenfall has announced that they expect to invest around 1.1 - 1.3 million € in KF(2016 prices) corresponding to 1.97 €/MW (2015 prices). No project costs have been published for the remaining offshore farms in Table 2.

Looking at Vattenfall's announcements, CAPEX per. MW has decreased just 15-25% from HR3(primo 2015) to KF (end 2016), while the bid price per kWh decreased about 50%. Hence, other parameters affecting the bid price for KF must have decreased more than the investment costs. Some explanations could be, for example, lower financial costs and increased competition, scale effect (KF is larger than HR3, advantages of many projects in a short period [IRENA, October 2016], and of projects located nearby, i.e. reduction of costs for ships and other facilities.

Near shore wind farms; Vesterhav north and Vesterhav south, are included in the analysis. However, it is assumed that the ocean depth is the same as for offshore wind turbines (15-25 m), and the two farms can be seen as one 350MW project, as Vattenfall has won both bids and that there will be a synergy with HR3. Hence, the costs of the Vesterhav (north) and Vesterhav (South) are assumed lower than for average near shore wind farm.

OPEX

No OPEX has been announced for the winning bids in 2015 and 2016 (HR3, KF, near shore and Borssele 1-4). Therefore, OPEX (FID 2015) has been determined based on the announced average OPEX for existing offshore wind mills owned by DONG (in 2016), indications from interviews with the industry and analysis of bid prices. The average OPEX for DONG Energy's existing parks is approx. 0.086 million € per. MW per year. Hereafter OPEX for 2015 (FID) has been assumed approx. 10% lower than the average for existing parks.

OPEX and CAPEX

In addition to the above considerations, an assessment of OPEX and CAPEX has been done by calculating internal interest rates and then evaluating the calculated internal return based on the expectation that a significantly lower rate of return is accepted at the end of 2016 than at the beginning of 2015. The calculation includes several other parameters that are subject to considerable uncertainty, for example projection of electricity prices and expected annual electricity production. The entire method is thus subject to great uncertainty, but is considered to be the best approach, taken into account the available information. Table 2 shows data for the mentioned projects.

	Horns rev 3	Near shore	Borssele 1+2	Krigers flak	Borssele 3+4
Internal interest rate relative to the period 2015-2016	High	Middle	Middle	Low	Low
Farm size (MW)	406,7	350	700	600	700
Expected windmill size (MW) ¹⁴	8,3	8-10	6-10	8-10	8
Distance from coast (km)	30	4-7	31	15-25,5	15-37
Sea depth (m)	11-19	10-25	14-38	15-30	40
Feed in tariff (DKK / MWh)	770	468	534	366	400
Estimated grant period (year)	11.2	11.1	15.0	11.2	14.7
Commission Year	2020	2020	2020	2021	2023
Production in the commission year ¹⁵	25%	25%	25%	10%	50%
FID year(assumed)	2015	2017	2017	2018	2020
Expected electricity price projection ¹⁶	EUBF14 minus 10 %		EUBF14	EUBF14 minus 10 %	EUBF14
Time for publication of winning bid	Feb. 2015	Sept. 2016	July 2016	Nov. 2016	Dec. 2016
Winner of the project	Vattenfall		DONG	Vattenfall	Shell
CAPEX (M€/MW) +/- 0,5	2.46	2.07	2.09	1.81-2.13	1.92
OPEX(M€/MW/år) +/- 0,02	0.077	0.064	0.071	0.062	0.059

Note 1: Data with red print are own assessments.

Note 2: OPEX is stated as a total costs, which covers an assumption of 75% fixed costs and 25% that vary with production.

Note 3: In the assessment, it has been assumed that costs of nearshore wind farms are approx. 10% lower than for offshore wind farms. Moreover, it has been taken into account that the costs for near shore wind farm, as reflected in the bids, include payment for grid connection. CAPEX for near shore wind mills, however, is excl. grid connection.

Table 3: Data for Danish and Dutch projects for which tenders were submitted in 2015 and 2016 (2015 prices).

Prediction of Grid connection costs for the period 2015 to 2050

The assessment of costs of grid connection is based on information from Energinet about the costs of connecting the latest four projects (HR2, Rødsand 2, Anholt and HR3) with emphasis on on the latest projects. Based on this, it is estimated that grid connection costs are approx. 0.4 M € / MW for offshore wind farms with

¹⁴ <http://www.4coffshore.com/windfarms/vesterhav-nord-denmark-dk55.html>

¹⁵ Production in the first year in percentage of full production, - not all the turbines are in service January 1 in the first year of production.

¹⁶ "EUBF14" is an electricity price projection used by the Danish Energy Agency, at the time of the tender. After 2024, the average spot market price for electricity is expected to be 28.5€/MWh. For "EUBF minus 10%" the electricity price is 10% lower. EUBF minus 10% is assumed for Danish offshore wind farms because the wind-weighted electricity price in Denmark is expected to be lower than average. "EUBF14" is used for Dutch parks because there is an expectation of a slightly higher electricity price in the Netherlands.

transformer station located on offshore platform, farm size 400-600MW and located about 30 km from the coast. Moreover, it is assumed that the grid connection costs are approx. 0.3 M € / MW for near shore wind farms that are connected to onshore transformer stations, farm size 50-200 MW, and located 4-10 km from the coast. Distribution of costs is shown in Table 5.

Grid connection costs (FID 2015, 2015 prices)		Off shore wind mills	Near shore wind mills
Total costs ¹⁷	mio. €/MW	0.40	0.28
Offshore platform	mio. €/MW	0.16	0.00
Project management and environmental assessment	mio. €/MW	0.027	0.040
Transformer station onshore	mio. €/MW	0.067	0.10
Sea cable total costs	mio. €/MW	0.081	0.040
Land cable total costs	mio. €/MW	0.067	0.10
Sea cable costs per km	DKK/km/MW	2,685	4,027
Land cable costs per km	DKK/km/MW	1,342	2,013
Sea cable length	Km	30	10
Land cable length	Km	50	50

Table 4: Network connection costs for offshore wind farms of 400-600MW and near shore wind farms of 50-200MW

Prediction of costs of grid connection in the future has been calculated by assuming that the costs drop by 1% per year until 2020, by 0.75% per year between 2020 and 2030 and by 0.5% per year after 2030. The learning rate method is not used because some parts of the grid connection technology are considered mature while other parts are not, consequently different parts will be at different stages on the learning curve and consequently it is also difficult to assess the accumulation of “capacity put into operation”.

Prediction of cost for the period from 2010 to 2050

The overall quality of offshore wind sites is expected to be at the same level as the current offshore wind sites with respect to distance to shore, water depth, wind speed etc. After 2030 the best wind sites are expected already to be utilized and slightly worse wind sites will be used resulting in an increased cost per kWh relative to an average pre 2030 wind site [14]. The main drivers for this increase in cost will be distance to shore and water depth since the post 2030 wind sites are expected to be located in the Northern Sea.

As mentioned above the project costs of offshore wind farms commissioned in the first years of the century were substantially lower than the costs of projects commissioned during recent years. Project costs appear to be levelling off now after having steadily increased over the last decade [10].

Significant cost reductions are expected in the future as a consequence of research and development efforts in relation to all main factors affecting the total cost of energy – turbine performance vs cost, foundation costs, electrical infrastructure costs and O&M.

¹⁷ Energinet.dk marts 2017

Furthermore, ambitious deployment plans for offshore wind power in Denmark and the rest of Europe in the coming years are expected to reduce the capital cost, the O&M costs and the construction time of offshore wind farms through increased industrialization and economics of scale.

MegaVind has set a target of a 50% reduction in LCOE for offshore wind from 2010 to 2020 [18].

In 2011 The British Department of Energy and Climate Change (DECC) set the goal to reduce LCOE of offshore wind power by 30% by 2020 for off shore wind under British conditions. Furthermore, the studies estimate that the cost reduction is on track or ahead of the goal [19].

The Dutch government has set a goal to reduce LCOE of offshore wind by 40% from 2010 to 2020 FID. A reduction potential of 46 % is found assuming that the potential covers technology as well as supply chain and financial cost reduction [20].

A study from Germany assesses two scenarios of offshore wind power penetration in Europe, three site characteristics and the corresponding cost reductions from 2013 to 2023. 17-27% cost reductions are estimated in capital cost in the period leading to a capital cost of 3,057-3,440 M€/MW in 2023. O&M costs are expected to reduce 19-33% by 2023. On the wind site most similar to Danish wind sites, reduction in LCOE of 29-36% are expected in the period achieving [17].

The above mentioned sources are the basis of the projections in the data sheet along with information about the existing offshore wind farms. The theory of learning rates is used to project price reductions from 2020 to 2030 [21].

Only few of the sources described above provide a full set of data including detailed cost reduction in investment and O&M, interest rate, projected deployment, etc. Furthermore, most of them do not look any further than year 2020. Therefore the estimates in these sources are only used as indications of a level of cost reduction.

After 2030, the learning rate approach with origin in European deployment is not assumed to be valid because the technological development is expected to be more affected by the global market development. Therefore a cost reduction is estimated rather than a learning rate from 2030 to 2050.

Based on these sources, the learning rates are assumed to be around 10% for both investment and O&M cost for offshore and slightly lower for nearshore because some of the expected cost reductions are related to offshore substations, deep waters and long distance to shore. Furthermore the same cost reduction is assumed for investment and O&M in the period (2030-2050) as in the period (2020-2030) for both offshore and nearshore.

These projections result in a learning rate for reduction in cost of electricity production which is a central estimate compared to the above mentioned reduction goals and cost projections. The absolute costs of offshore wind power electricity production are significantly lower in Denmark than in comparable countries today and in the projections due to the framework conditions and excellent Danish offshore wind sites.

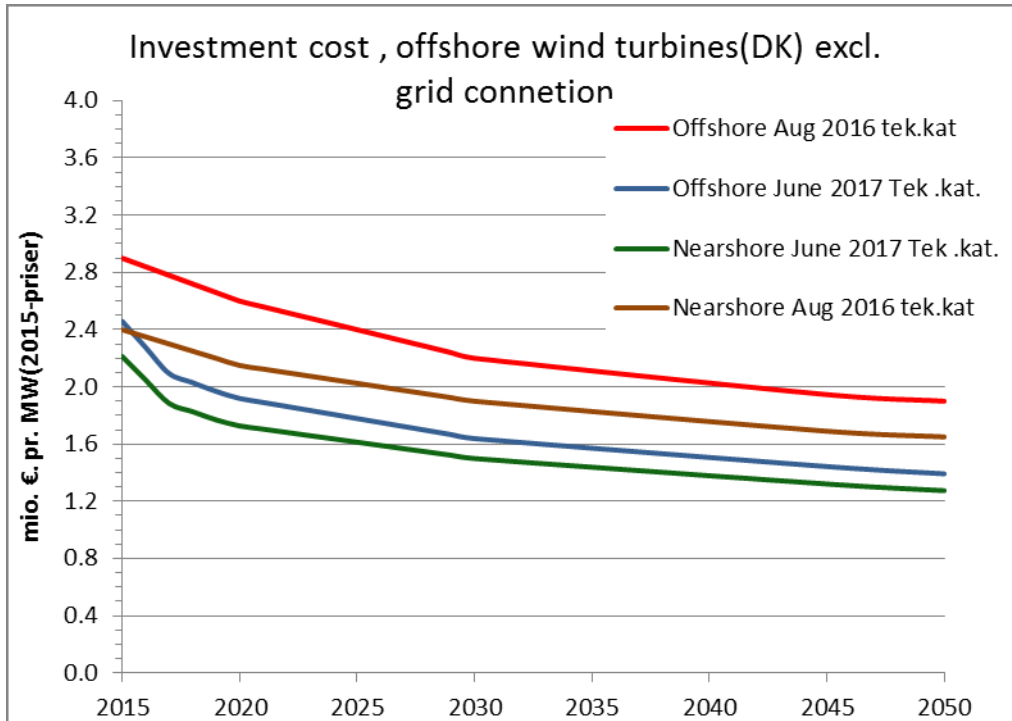

Figure 11: Expected development in investment cost (excl. grid connection) wind farms in Denmark

Uncertainty

There are several uncertainties, not just in cost and improvement of performance of the technology, but also on supply chain and service opportunities. The cost reductions related to supply chain and service is dependent on the international level of deployment of wind power as well as the national availability of service which is dependent on the continuity and level of national deployment of offshore wind power.

Future demands offshore

In the future it could be expected that the offshore wind turbines will be met with

- More focus on wildlife issues due to larger and more numerous projects
- More demands on participation in grid regulation and grid expansion in general

Data sheets

Technology	Large wind turbines, Off-shore									
Year of final investment decision	2015	2020	2030	2050	Uncertainty (2020)		Uncertainty (2050)		Note	Ref
Energy/technical data					Lower	Upper	Lower	Upper		
Generating capacity for one unit (MW)	8	10	12	15	4.0	10.0	4.0	20.0	A1	6, 13, 10
Average annual full-load hours	4,400	4,500	4,650	4,900	4,000	5,000	4,000	5,500	A	8, 10, 27
Forced outage (%)	4.0%	3.0%	3.0%	2.0%	1.0%	5.0%	1.0%	5.0%	B	27
Planned outage (%)	0.3%	0.3%	0.3%	0.3%	0.1%	0.5%	0.1%	0.5%	C	
Technical lifetime (years)	25	27	30	30	20	35	20	35	D	
Construction time (years)	3	2.5	2.5	2	1.5	4	1.5	4	E	27
Space requirement (1000m2/MW)	185	185	185	185	168	204	168	204	F	14
Regulation ability										
Primary regulation (% per 30 sec.)									G	
Secondary regulation (% per min.)									G	
Financial data										
Nominal investment (M€/MW) excl. grid connection	2.46	1.92	1.64	1.39	1.73	2.02	1.11	1.53	H,J,K	10, 15, 16, 30, 31,33,34
Nominal investment (M€/MW) grid connection	0.40	0.38	0.35	0.32	0.35	0.41	0.27	0.37	L	31,35
- of which equipment	45%	45%	45%	45%	40%	50%	40%	50%		26, 12, 27
- of which installation	55%	55%	55%	55%	50%	60%	50%	60%		26, 12, 27
Fixed O&M (€/MW/year)	57,300	44,300	37,800	32,100	39,900	46,500	25,700	35,300	I, J	31, 32, 34
Variable O&M (€/MWh)	4.3	3.3	2.7	2.2	3.0	3.4	1.7	2.4	I, J	26, 12, 27, 31,32,34
Technology specific data										
Rotor diameter	164	190	210	240	---	---	---	---		14, 10
Hub height	103	115	125	140	---	---	---	---		14, 10
Specific power (W/m2)	379	353	346	332						
Average capacity factor (%)	50	51	53	56	46	57	46	63		8, 27
Average availability (%)	96%	97%	97%	98%	99%	95%	99%	95%		27
Specific area coverage (MW/km2)	5.4	5.4	5.4	5.4	4.9	5.9	4.9	5.9		14, 10

Notes:

A1 The capacity in 2015 is set to 8 MW since the only offshore windfarm decided in 2015 was Horns Rev 3 with turbines of 8.3 MW.

- A The full load hours (annual production (MWh) per installed power (MW)) depending on the actual location of the wind farm, wake losses and technological characteristics of the individual turbine. The value is an average for location where it is expected the turbines will be placed. Specific area coverage 5.4 MW/km² is assumed, further more it is assumed that offshore turbines are in farms with a total capacity of app. 400-600 MW.
- B Offshore turbines has typically higher forced outage than onshore due to access problems in harsh weather
- C Planned outage is typically 1-2 service visits a year, with a 1-2 work days
- D The life time depends on the wind conditions; average annual speed and turbulence, relative to the design class of the turbine
- E The construction time is the period from FID to commissioning. The construction time depend on the size of the project, vessel available and weather conditions.
- F Based on 5,4 MW/km² - can vary some and will often be a political decision - a given area is available and a number of MW tendered. The wake losses will highly depend on the space available per MW.
- G Wind turbines can be downward regulated within very short time and can therefore (if the wind is blowing) be used in both the primary and secondary downward regulation.
- H The cost includes cost of wind turbines, foundation, installation, planning & development and financing and internal grid connection (array cable, substation but not export cable).
- I 75 % of the total yearly O&M costs are assumed to be fixed cost and 25 % are assumed to be variable cost.
- J From 2020-2030 10% learning rate is assumed, from 2030-2050 15% reduction is assumed
- K Deducted from , five tenders have been settled for offshore wind farms in Denmark and in the Netherlands, described in details in the note [31]
- L Assuming that the costs drop by 1% per year between 2015 and 2020, by 0.75% per year between 2020 and 2030 and by 0.5% per year after 2030

Technology	Large wind turbines, Near-shore									
Year of final investment decision	2015	2020	2030	2050	Uncertainty (2020)		Uncertainty (2050)		Note	Ref
Energy/technical data					Lower	Upper	Lower	Upper		
Generating capacity for one unit (MW)	8	10	12	15	4.0	10.0	4.0	20.0	A1	6, 13, 10
Average annual full-load hours	4400	4500	4650	4900	4000	5000	4000	5500	A	8, 10, 27
Forced outage (%)	3.5%	3.0%	2.5%	2.0%	1.0%	5.0%	1.0%	5.0%	B	27
Planned outage (%)	0.3%	0.3%	0.3%	0.3%	0.1%	0.5%	0.1%	0.5%	C	
Technical lifetime (years)	25	27	30	30	20	35	20	35	D	
Construction time (years)	2	2	2	2	1	3	1	3	E	27
Space requirement (1000m2/MW)	185	185	185	185	168	204	168	204	F	14
Regulation ability										
Primary regulation (% per 30 seconds)									G	
Secondary regulation (% per minute)									G	
Financial data										
Nominal investment (M€/MW) excl. grid connection	2.21	1.73	1.50	1.28	1.56	1.82	1.00	1.38	H,K,J	10, 15, 16, 30, 31,33,34
Nominal investment (M€/MW) grid connection	0.28	0.27	0.25	0.22	0.24	0.29	0.18	0.27	L	31,35
- of which equipment	45%	45%	45%	45%	40%	50%	40%	50%		26, 12, 27
- of which installation	55%	55%	55%	55%	50%	60%	50%	60%		26, 12, 27
Fixed O&M (€/MW/year)	51,570	39,870	34,020	28,890	42,800	52,400	29,000	43,600	I, J, K	31, 32, 3
Variable O&M (€/MWh)	3.9	3.0	2.4	2.0	3.2	3.9	2.0	3.0	I, J, K	26, 12, 27, 31,32,34
Technology specific data										
Rotor diameter	164	190	210	240	---	---	---	---		14, 10
Hub height	103	115	125	140	---	---	---	---		14, 10
Specific power (W/m2)	379	353	346	332						
Average capacity factor	50%	51%	53%	56%	46%	57%	46%	63%		8, 27
Average availability (%)	96%	97%	97%	98%	99%	95%	99%	95%		27
Specific area coverage (MW/km2)	5.4	5.4	5.4	5.4	4.9	5.9	4.9	5.9	F	14, 10

Notes:

A1 The capacity is set to 8 MW, the turbines at Horns Rev 3 is expected to have a capacity of 8.3 MW, it is assumed that the same turbines will be used near shore and off shore

- A The full load hours (annual production (MWh) per installed power (MW)) depending on the actual location of the wind farm, wake losses and technological characteristics of the individual turbine. The value is an average for location where it is expected the turbines will be placed. A specific area coverage 5,4 MW/km² is assumed, furthermore it is assumed that nearshore turbines are placed in farm with a total capacity of 50 -250 MW
- B Offshore turbines has typically longer forced outage than onshore due to access problems in harsh weather
- C Planned outage is typically 1-2 service visits a year, with a 1-2 work days
- D The life time depends on the wind conditions; average annual speed and turbulence, relative to the design class of the turbine
- E The construction time is the period from FID to commissioning. The construction time depend on the size of the project, vessel available and weather conditions.
- F The wake losses will highly depend on the space available per MW, Specific area coverage of 5,4 MW/km² is assumed. In a tender typically a given area is available and a given capacity MW is demanded.
- G Wind turbines can be regulated downward within short time and can therefore (if the wind is blowing) be used in both the primary and secondary downward regulation.
- H The cost includes cost of wind turbines, foundation, installation, planning & development and financing and internal grid connection(array cable)
- I 75 % of the total yearly O&M costs are assumed to be fixed cost and 25 % are assumed to be variable cost.
- J 9% learning rate is assumed for total investment cost and for O&M between 2020 and 2030
- K Deducted from , five tenders have been settled for offshore wind farms in Denmark and in the Netherlands, described in details in the note [31] Assuming that Nearshore wind farms is 10% cheaper than offshore in 2015 and 2020.
- L Assuming that the costs drop by 1% per year between 2015 and 2020, by 0.75% per year between 2020 and 2030 and by 0.5% per year after 2030

References

- [1] E. I. a/s, <http://www.windprospecting.com/>, 2015.
- [2] Enercon Product overview, 2012. [Online]. Available: http://www.enercon.de/p/downloads/ENERCON_PU_en.pdf.
- [3] Siemens Wind Power, 2014. [Online]. Available: <http://www.energy.siemens.com/br/pool/hq/power-generation/renewables/wind-power/Product-Sheet-HWRT.pdf>.
- [4] DEA, Information's from expert workshop held by DEA, 27-4-2015.
- [5] In-house estimation of hourly power output from an offshore wind farm in the North Sea.
- [6] The European offshore wind industry – key trends and statistics 2015, EWEA, 2016.
- [7] Offshore Wind Cost Reduction Pathway Study, The Crown Estate, 2012.
- [8] Master data register of wind turbines at end of December 2014, Danish Energy Agency (the analysis also utilize earlier years of the same register).
- [9] The Danish offshore wind farm demonstration project: Horns Rev and Nysted offshore wind farms. Review report 2005, DONG Energy and Vattenfall, 2006.
- [10] DTU International Energy Report – Wind Energy, DTU, 2014.
- [11] Energy Technology Perspectives 2008, IEA, 2008.
- [12] Renewable Energy Technologies: Cost Analysis Series, IRENA, 2012.
- [13] B. Christensen, Interviewee, Personal communication/Interviews with Siemens Wind Power + written contribution. [Interview].
- [14] Fremtidens havmølleplaceringer - 2025 (Future locations for offshore wind farms; in Danish),” Danish

Energy Agency, 2007.

- [15] Lindø Offshore Renewables Centre, data on offshore wind farms.
- [16] 4 C Offshore, global offshore wind farms database [Online]. Available: <http://www.4coffshore.com/windfarms/default.aspx>.
- [17] Fichtner/Prognos, Cost Reduction Potentials of Offshore Wind Power in Germany, 2013.
- [18] DENMARK - SUPPLIER OF COMPETITIVE OFFSHORE WIND SOLUTIONS, Megavind, 2013 May.
- [19] Catapult, Crown Estate.
- [20] DENMARK - SUPPLIER OF COMPETITIVE OFFSHORE WIND SOLUTIONS, TKI Wind Op Zee, 2015.
- [21] Wind energy scenarios for 2030, EWEA, 2015.
- [22] 2015. [Online]. Available: <http://www.windprospecting.com/>.
- [23] [Online]. Available: http://www.wind-power-program.com/turbine_characteristics.htm .
- [24] Energiaftalen, 2012.
- [25] Aftale om tilbagerulning af FSA mv. og lempelser af PSO, 14. juli 2014.
- [26] The Economics of Wind Energy, EWEA, 2009.
- [27] N. m.fl., Vindmøllers økonomi, EUDP projekt 33033-0196, 2010.
- [28] Costs of low carbon generation technologies, Committee on Climate Change & Mott MacDonald, 2011, 9 May.
- [29] E. I. a/s, <http://www.windprospecting.com/>, 2015.
- [30] <http://www.4coffshore.com/windfarms>, accessed 27-3-2017
- [31] Note made by DEA: "Notat om teknologiomkostninger for havvind, baggrund for opdatering af CAPEX og OPEX i Teknologikatalogets dataark". Energinet and the Danish Energy Agency, 2017, March 28.
- [32] DONG ENERGY Investor presentation, , DONG Energy, 2016, 12 May
- [33] Cost Reduction Monitoring Framework 2016, Offshore Wind Programme Board, Catapult 2016, 2016
- [34] Innovation Outlook: Off shore Wind, International Renewable Energy Agency (IRENA), Abu Dhabi, 2016
- [35] Energinet, March 2017

22 Photovoltaics

This chapter is under review.

This chapter has been moved from the previous Technology Data Catalogue for Electricity and district heating production from May 2012. Therefore, the text and data sheets do not follow the same guidelines as the remainder of the catalogue.

The datasheet for large scale utility system photovoltaics has been updated in October 2017 and can be found here below. A note (in Danish) documenting the updating can be found at <http://www.ens.dk/info/tal-kort/fremskrivninger-analyser-modeller/teknologikataloger>

Contact information:

Danish Energy Agency: Rikke Næraa, rin@ens.dk

Author: EA Energy

Publication date

March 2015

Amendments after publication date

Date	Ref.	Description
November 18	Qualitative description	Qualitative description for financial data added
July 18	Data sheet	Updated data sheets for small and medium sized systems
October 17	Data sheet	Updated data sheets for large utility scale PV systems

Brief technology description

A solar cell is a semiconductor component that generates electricity when exposed to light. For practical reasons several solar cells are typically interconnected and laminated to (or deposited on) a glass pane in order to obtain a mechanical ridged and weathering protected solar module. The photovoltaic (PV) modules are typically 1 – 2 m² in size and have a power density in the range 100 - 210 W_p pr. m². They are sold with a product guarantee of typically two-five years, a power warranty of minimum 25 years and an expected lifetime of more than 30 years.

PV modules are characterised according to the type of absorber material used:

- Crystalline silicon (c-Si); the most widely used substrate material is made from purified solar-grade silicon and come in the form of mono- or multi-crystalline silicon *wafers*. Currently more than 90 pct. of all PV modules are wafer-based divided between multi- and mono-crystalline with a 60:40 share of the market size (this division is expected to level out towards a 50:50 ratio over the coming years, Ref. 3 & 13). This technology platform is expected to dominate the world market for decades due to significant cost and performance advantages (Ref 1, 2, 3 & 13).

- Thin film solar cells; where the absorber can be an amorphous/microcrystalline layer of silicon (a-Si/ μ c-Si), Cadmium telluride (CdTe) or Copper Indium Gallium (di)Selenide (CIGS). These semiconductor materials are deposited on the top cover glass of the solar module in a micrometre thin layer. Tandem junction and triple junction thin film modules are commercially available. In these modules several layers are deposited on top of each other in order to increase the efficiency.
- Monolithic III-V solar cells; that are made from compounds of group III and group V elements (Ga, As, In and P), often deposited on a Ge substrate. These materials can be used to manufacture highly efficient multi-junction solar cells that are mainly used for space applications or in Concentrated Photovoltaic (CPV) systems. CPV mainly utilises the direct beam component of the solar irradiation, which is not decisive under Danish conditions. Dye-Sensitized solar Cells (DSC) and Polymer/Organic Solar Cells; are emerging technologies where significant research activities are among others currently addressing efficiency and lifetime issues. These cells are expected to develop into commercial products by 2020-2030 (Ref. 3), but are currently not considered candidates for grid-connected systems. The general view on polymer/organic solar cells has been, and still is, that they are suited for low-demanding applications (typically recharging of batteries) but will face challenge in large-scaled, grid-connected installations. This view is, however, presently questioned as a consequence of significant R&D achievements in recent years; breaking of the 10pct. efficiency limit (achieved for small laboratory cells) and a demonstration of large-scale power production with a competitive energy payback and prospects for cost competitiveness.
- Perovskite material PV cells; Perovskite solar cells are in principle a DSC cell with an organo-metal salt applied as the absorber material. Perovskites can also be used as an absorber in modified (hybrid) organic/polymer solar cells. The potential to apply perovskite solar cells in a multi-stacked cell on e.g. a traditional c-Si device provides interesting opportunities. Perovskite-based solar cells have, under lab conditions, shown a remarkable progress over the years when rated with respect to efficiency. Within five years the efficiency has increased quite significantly from about 5 pct. to almost 20 pct. The perovskites potential is, however, paired with serious concerns related to their toxicity. The best perovskite absorbers contain soluble organic lead compounds that are toxic and environmentally hazardous at a level that calls for extraordinary precautions. Therefore the perovskite's health and environmental impact shall be analyzed before they are eventually considered as a viable absorber material in solar cells. Furthermore challenges in industrial scale manufacturing are presently not solved.

In addition to PV modules, a grid connected PV system also includes Balance of System (BOS) consisting of a mounting system, dc-to-ac inverter(s), cables, combiner boxes, optimizers, monitoring/surveillance equipment and for larger PV power plants also transformer(-s).

Input

Solar radiation.

The irradiation, which the module receives, depends on the solar energy resource potential at the location, including shade and the orientation of the module (both tilting from horizontal plane and deviation from facing south).

The average annual solar energy received on a horizontal surface in Denmark is $1046 \pm 33 \text{ kWh/m}^2/\text{year}$ (Ref. 4).

The distribution of this solar energy over the year is illustrated in the Figure 1.

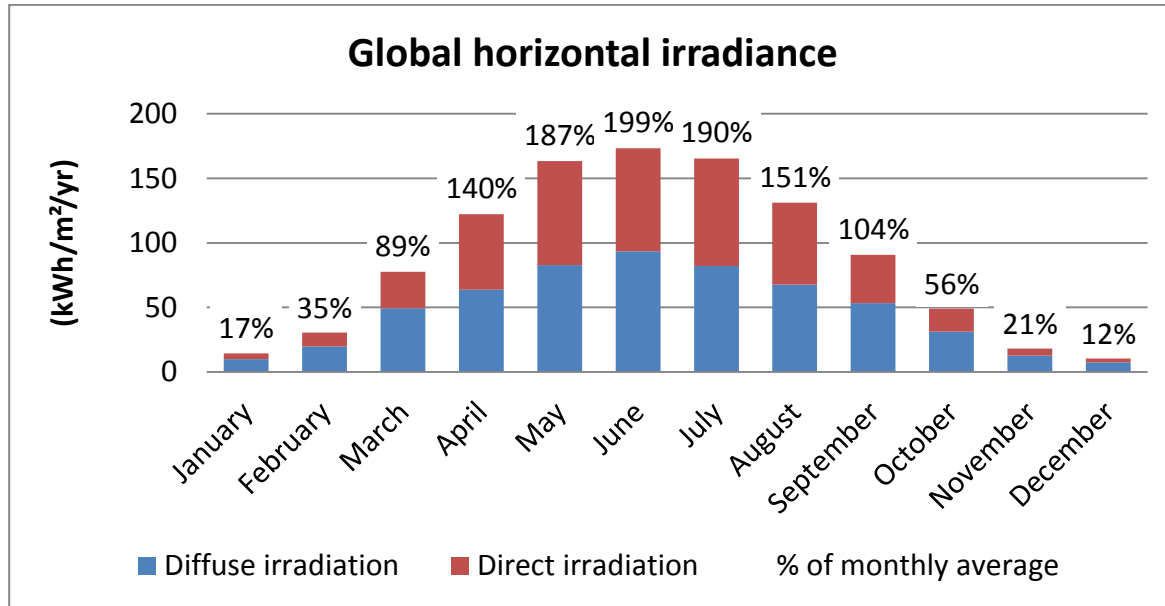

Figure 1: Monthly sum of global irradiance on a horizontal surface averaged over 25 Danish measurement stations over a period of 10 years (2001-2010) (Ref 4). The split between direct and diffuse components of the irradiation is based on the Meteonorm '97 dataset for Copenhagen. Percentage of average monthly is also shown.

Both direct light (beam) and diffuse components of the light – which in Denmark typically comprise approx. 50 pct. of the energy - can be utilised. This implies a fairly high degree of freedom in orienting the PV modules, both with respect to inclination and orientation East-West.

For a fixed tilt system, where modules are installed in a 15-45 deg. tilt angle, the available energy received in the plane of the PV module (glass surface) is increased compared to horizontal by a so-called transposition factor of 1.1 - 1.15.

Modules facing other directions than South receive less energy than modules facing directly towards South. Table 1 shows the transposition factor for different orientations of the module.

Orientation of solar panels													
Tilt angle	West		South-West			South			South-East			East	
	90°	75°	60°	45°	30°	15°	0°	15°	30°	45°	60°	75°	90°
0°	1,00	1,00	1,00	1,00	1,00	1,00	1,00	1,00	1,00	1,00	1,00	1,00	1,00
5°	1,00	1,01	1,02	1,03	1,03	1,04	1,04	1,04	1,03	1,03	1,02	1,01	1,00
10°	0,99	1,01	1,03	1,05	1,05	1,07	1,07	1,07	1,06	1,05	1,03	1,01	0,99
15°	0,98	1,01	1,04	1,07	1,08	1,09	1,10	1,10	1,08	1,06	1,04	1,01	0,98
20°	0,97	1,01	1,05	1,08	1,10	1,12	1,12	1,12	1,10	1,08	1,05	1,01	0,97
25°	0,96	1,01	1,06	1,09	1,12	1,13	1,14	1,13	1,12	1,09	1,05	1,01	0,96
30°	0,95	1,01	1,06	1,10	1,12	1,14	1,15	1,14	1,13	1,09	1,05	1,01	0,95
35°	0,94	1,00	1,05	1,10	1,13	1,15	1,15	1,15	1,13	1,09	1,05	1,00	0,94
40°	0,92	0,99	1,04	1,09	1,12	1,14	1,15	1,14	1,13	1,09	1,04	0,99	0,92
45°	0,91	0,98	1,03	1,08	1,12	1,14	1,14	1,14	1,12	1,08	1,03	0,97	0,90
50°	0,89	0,96	1,02	1,07	1,10	1,12	1,13	1,12	1,10	1,07	1,02	0,95	0,88
55°	0,87	0,94	1,00	1,05	1,09	1,10	1,11	1,10	1,08	1,05	1,00	0,93	0,86
60°	0,84	0,92	0,98	1,03	1,06	1,08	1,09	1,08	1,06	1,02	0,97	0,91	0,84
65°	0,82	0,89	0,95	1,00	1,03	1,05	1,06	1,05	1,03	1,00	0,95	0,88	0,81
70°	0,79	0,86	0,92	0,97	1,00	1,02	1,02	1,01	1,00	0,96	0,92	0,86	0,79
75°	0,76	0,83	0,89	0,93	0,96	0,97	0,98	0,97	0,96	0,93	0,88	0,83	0,76
80°	0,73	0,79	0,85	0,89	0,92	0,93	0,93	0,93	0,91	0,89	0,85	0,79	0,73
85°	0,70	0,76	0,81	0,85	0,87	0,88	0,88	0,88	0,87	0,84	0,81	0,75	0,69
90°	0,66	0,72	0,77	0,80	0,82	0,83	0,83	0,83	0,82	0,80	0,77	0,72	0,66

Table 1: Transposition factor for solar modules as function of orientation calculated for Copenhagen by the program PVsyst based on the Meteonorm '97 dataset.

The irradiation to the module can be increased by mounting the module on a sun-tracking device. When using a single-axis tracker the available solar energy can be increased by up to a factor of 1.2, compared to horizontal and for two-axis trackers a transposition factor of 1.3 can be achieved in Denmark (Ref. 9). Tracker systems are currently not considered important under Danish conditions due to the limited absolute gain in energy production and the extra complexity and cost related to the moving parts.

Output

All PV modules generate direct current (DC) electricity as an output, which then needs to be converted to alternating current (AC) by use of an inverter; some modules come with an integrated inverter, so called AC modules, which exhibit certain technical advantages such as the use of standard AC cables, switchgear and a more robust PV module.

The electricity production depends on:

- The amount of solar irradiation received in the plane of the module (see above).
- Installed module generation capacity.
- Losses related to the installation site (soiling and shade).
- Losses related to the conversion from sunlight to electricity (see below).
- Losses related to conversion from DC to AC electricity in the inverter.
- Grid-connection and transformer losses.
- Cable length and cross section, and overall quality of components.

Power generation capacity

The capacity of a solar module is not a fixed value, as it depends on the intensity of the irradiation the module receives as well as the module temperature. For practical reasons the module capacity is therefore referenced to a set of laboratory Standard Test Conditions (STC) which corresponds to an irradiation of 1000 W/m^2 with an AM1.5 spectral distribution perpendicular to the module surface and a cell temperature of $25 \text{ }^\circ\text{C}$. This STC capacity is referred to as the peak capacity P_p [kW_p].

Losses and corrections

Normal operating conditions will often be different from Standard Test Conditions the average capacity of the module over the year will therefore differ from the peak capacity. The capacity of the solar module is reduced compared to the P_p value when the actual temperature is higher than $25 \text{ }^\circ\text{C}$, when the irradiation received is collected at an angle different from normal direct irradiation and when the irradiation is lower than 1000 W/m^2 . Besides, some of the electricity generated from the solar modules is lost in the rest of the system e.g. in the DC-to-AC inverter(s), cables, combiner boxes and for larger PV power plants also in the transformer. The energy production from a PV installation with a peak capacity P_p , can be calculated as: $P_p * \text{Global Horizontal Irradiation} * \text{Transposition Factor} * (1 - \text{Incident Angle Modifier loss}) * (1 - \text{PV systems losses and non-STC corrections}) * (1 - \text{Inverter losses}) * (1 - \text{Transformer losses})$.

Inverter capacity and sizing factor

The capacity of the inverter, also known as the rated power, defines the upper limit for power that can be delivered from the plant and defines the plant capacity, P [W_{AC}]. The relationship (P_p/P) between the peak capacity P_p [W_{DC}] and the plant capacity P is called the sizing factor. The sizing factor is optimised differently whether the limiting factor of the installation is; availability of area, availability of grid connection, legal constraints on the allowed nominal power, daily self-consumption profile, fixed physical orientation or tilt angle of the modules etc. The range for the sizing factor is generally within 1.0 to 1.3.

Wear and degradation

In general a PV installation is very robust and only requires a minimum of component replacement over the course of its lifetime. The inverter typically needs to be replaced every 10-15 years. For the PV module only limited physical degradation of a c-Si solar cell will occur. It is common to assign a constant yearly degradation rate of 0.25 – 0.5 pct. per year to the overall production output of the installation. This degradation rate does not represent an actual physical mechanism, but rather reflect general failure rates following ordinary reliability theory with an initial high (compared to later) but rapidly decreasing “infant mortality” followed by a low rate of constant failures and with an increasing failure rate towards the end-of-life of the various products (Ref. 13). Failures in the PV system is typical relate to soldering, cell crack or hot spots, yellowing or delamination of the encapsulant foil, junction box failures, loose cables, hail storm and lightning (Ref. 14).

Typical capacities

PV systems are available from μ watt to gigawatt sizes. But in this context it is only PV systems from a few hundred watt to GW gigawatt sizes which are relevant.

PV systems are inherently modular with a typical module unit size of 200-350 W_p.

The size of a typical *residential* installation in Denmark will be 4–6 kW_p corresponding to an area of 25-40 m² for c-Si modules. Residential PV installations are often optimised for a high degree of self-consumption, with a sizing factor of 1.0 – 1.2 and may deliver electricity to the low voltage grid.

Commercial PV systems are typically installed on residential, office or public buildings, and range typically from 50 to 500 kW in size. Such systems are often designed to the available roof area and for a high self-consumption. They will typically have a sizing factor around 1.1 – 1.2 and may deliver most of the electricity to either self-consumption or the low voltage grid.

Utility scale systems or PV power plants will normally be ground mounted and typically range in size from 0.5 MW to ~10 MW. They are typically operated by independent power producers that by use of transformers deliver electricity to the medium voltage grid and will have a sizing factor above 1.2.

Regulation ability

The production from a PV system reflects the yearly and daily variation in solar irradiation. Modern PV inverters may be remotely controlled by grid-operators and can deliver grid-stabilisation in form of reactive power, variable voltage and power fault ride-through functionality, but the most currently installed PV systems will supply the full amount of available energy to the consumer/grid.

However, without appropriate grid regulation in place, high penetration of PV can also lead to unwanted increase in voltage and other issues (Ref. 3 & 16).

Advantages/disadvantages

Advantages:

- PV does not use any fuel or other consumable.
- PV is noiseless (except for fan-noise from inverters).
- PV does not generate any emissions during operation.
- Electricity is produced in the daytime when demand is high.
- PV complements wind power.
- PV offers grid-stabilisation features.
- PV modules have a long lifetime of more than 30 years and PV modules can be recycled.

- PV systems are modular and easy to install.
- Operation & Maintenance (O&M) of PV plants is simple and limited as there are no moving parts and no wear and tear, with the exception of tracers. Inverters must only be replaced once or twice during the operational life of the installation.
- Large PV power plants can be installed on land that otherwise are of no commercial use (landfills, areas of restricted access or chemically polluted areas).
- PV systems integrated in buildings require no incremental ground space, and the electrical inter-connection is readily available at no or small additional cost.

Disadvantages:

- PV systems have high initial costs and a low capacity factor.
- Aesthetic concerns may limit the use of PV in certain urban environments and also in the open space when the visual impact is unacceptable.
- The output of the PV installation can only be adjusted negatively (reduced feed-in) according to demand as production basically follows the daily and yearly variations in solar irradiation.
- Materials abundance (In, Ga, Te) is of concern for large-scale deployment of some thin-film technologies (CIGS, CdTe).
- Some thin-film technologies do contain small amounts of cadmium and arsenic.
- The best perovskite absorbers contain soluble organic lead compounds, which are toxic and environmentally hazardous at a level that calls for extraordinary precautions.

Environment

The environmental impacts from manufacturing, installing and operating of PV systems are limited.

Thin-film modules may contain small amounts of cadmium and arsenic, but all PV modules as well as inverters are covered by the European Union WEEE directive, whereby appropriate treatment of the products by end-of-life is promoted.

The energy payback time of a typical crystalline silicon PV system in Southern Europe is 1.25 years (Ref. 5) which corresponds to 2 years in Denmark.

Research and development

A trend in research and development (R&D) activities reflects a change of focus from manufacturing and scale-up issues (2005-2010) and cost reduction topics (2010-2013) to implementation of high efficiency solutions and documentation of lifetime/durability issues (2013-). R&D is primarily conducted in countries where the manufacturing also takes place, such as Germany, China, USA, Taiwan and Japan. Nevertheless some R&D is also taking place in Denmark; the priorities in Denmark are (Ref. 6):

- Silicon feedstock for high-efficiency cells.
- New PV cells e.g. photo-electro-chemical, polymer cells and nanostructured cells.
- Inverters; increased technical lifetime, high efficiency and lower costs.
- System technology; incl. integration in the overall electricity system.
- Building integration of PV modules, design and aesthetics.

Efficiency and area requirements

The efficiency of a solar module, η_{mod} , expresses the fraction of the power in the received solar irradiation that can be converted to useful electricity. A typical value for commercially available PV modules today is 15-17 pct., with high-end products already above 20 pct., when measured at standard test conditions.

The module area needed to deliver 1 kW_p of peak generation capacity can be calculated as $1/\eta_{\text{mod}}$, and equals 6.25 m² by today's standard PV modules. For modules on tilted roofs, 1 m² of roof area is needed per m² of module area. Modules on flat roofs and modules on ground will typically need more roof and land area than the area of the modules itself, in order to avoid too much shadow from the other modules. The table below shows typical ratios of the area of the module to the ground surface required for the installation, so-called ground coverage ratios. For residential installations, the table shows the ratio between module area and roof area (assuming tilted roof installation).

	Residential	Commercial	Utility
Ground coverage ratio (ref. 9)	1.00	0.80	0.60

Examples of best available technology

High efficiency solar cells and modules have been available for a decade based on interdigitated back contact or hetero-junction cell technologies. The efficiency of such monocrystalline solar cells is above 24 pct. and PV modules with an efficiency of more than 20 pct. are already commercially available.

The maximum efficiency of c-Si solar PV cells is theoretically estimated to be approximately 29 pct., whereas three-junction solar PV cells can reach up to 49 pct.

Not only the efficiency but also the reliability of PV modules has improved significantly over the last years (based on extensive research in materials science and accelerated/field tests of components and systems, and best-in-class manufacturers now offer product warranties for materials and workmanship up to 25 years and power warranties with a linear degrading warranty from initially 95pct. of the peak power value to a level of 87pct. after 25 years.

Additional remarks

At present time in Denmark PV modules account for roughly 50 pct. of total system costs. Mounting structures, inverters, cabling etc. accounts for the rest (Ref. 2 & 13).

Due to a fast increase in production capacity in all steps of the value-chain for c-Si PV modules and the accompanied cost reduction related to mass production and availability of standardised production equipment as well as intense market competition, the prices of PV modules and Balance-Of-Plant components have decreased rapidly in the period 2011-2014. This decrease has not been reflected in the prices for plants in Denmark 2012-2014 [7, 17, 19, 20, 21, 22, 23, 24 and 25].

Data sheets

Data sheet for large utility scale PV-systems updated October 2017

Data sheet for small residential and medium size commercial PV-systems updated July 2018

Technology	Photovoltaics: SMALL residential systems					
	2015	2020	2030	2050	Note	Ref
Input						
Global horizontal irradiance (kWh/m ² /y)	1,068	1,068	1,068	1,068	A	4
Energy/technical data						
Typical capacity for one installation (kW)(plant capacity)	6	6	6	6	B	
Typical peak capacity for one installation at STC (kWp)	6.3	6.3	6.3	6.3	B1, C	
Energy/technical data - system design						
DC/AC sizing factor (Wp/W)	1.05	1.05	1.05	1.05	D	
Transposition Factor for fixed tilt system	1.10	1.10	1.10	1.10	E	
Incident Angle Modifier Loss (%)	3.5%	2.5%	1.5%	1.0%	F	13
PV systems losses and non-STC corrections (%)	15.0%	12.0%	10.0%	7.0%	G	
Inverter loss (%)	3.0%	1.5%	1.5%	1.0%	H	13
AC grid losses (%)	0%	0%	0%	0%	I	
PV module conversion efficiency (%)	16.5%	19%	23%	26%		
Availability (%)	100%	100%	100%	100%		
Technical lifetime of total system (years)	30	35	40	40		
Inverter lifetime (years)	10	15	15	15		
Output						
Full load hours (kWh/kW)	981	1,043	1,077	1,124	L	
Peak power full load hours (kWh/kWp)	935	993	1,026	1,071	K, L	
Financial data						
PV module cost (2015-€/Wp)	0.73	0.31	0.23	0.16	O	3,11,13
Balance Of Plant cost (2015-€/Wp)	0.77	0.76	0.60	0.40	O	-

Specific investment, total system (2015-€/Wp)	1.50	1.07	0.83	0.56	L, M, N, S	3,10,17,18,20,21,22,23,24,25,26,27,28,29
Specific investment, total system (2015-M€/MW)	1.58	1.13	0.87	0.59	P, Q	-
Fixed O&M (2015€/MWp/y)	15,000	12,800	10,300	8,700	R	3,10
Fixed O&M (2015€/MW/y)	15,750	13,440	10,815	9,135		

Residential PV installation with a typical capacity of 4–6 kW, mounted on the roof.

Technology	Photovoltaics: MEDIUM sized commercial systems					
	2015	2020	2030	2050	Note	Ref
Input						
Global horizontal irradiance (kWh/m ² /y)	1,068	1,068	1,068	1,068	A	4
Energy/technical data						
Typical capacity for one installation (kW)(plant capacity)	100	100	100	100	B	
Typical peak capacity for one installation at STC (kWp)	110	110	110	110	B2, C	
Energy/technical data - system design						
DC/AC sizing factor (Wp/W)	1.1	1.1	1.1	1.1	D	
Transposition Factor for fixed tilt system	1.1	1.1	1.1	1.1	E	
Incident Angle Modifier Loss (%)	3.5%	2.5%	1.5%	1.0%	F	13
PV systems losses and non-STC corrections (%)	14.0%	9.0%	7.0%	5.0%	G	
Inverter loss (%)	2.5%	1.5%	1.5%	1.0%	H	13
AC grid losses (%)	0%	0%	0%	0%	I	
PV module conversion efficiency (%)	16.5%	19.0%	23.0%	26.0%		13
Availability (%)	100%	100%	100%	100%		
Technical lifetime of total system (years)	30	35	40	40		
Inverter lifetime (years)	10	15	15	15		
Output						
Full load hours (kWh/kW)	1,046	1,129	1,166	1,203	L	
Peak power full load hours (kWh/kWp)	951	1,027	1,060	1,094	K, L	
Financial data						
PV module cost (2015-€/Wp)	0.70	0.29	0.21	0.14	M,Q	3,11,13
Balance Of Plant cost (2015-€/Wp)	0.53	0.44	0.37	0.31	M	-
Specific investment, total system (2015-€/Wp)	1.22	0.73	0.57	0.45	L, M, N, S	3,10,17,18,20,21,22,23,24,25,26,27,28,29
Specific investment, total system (2015-M€/MW)	1.34	0.80	0.63	0.49	M, Q	-
Fixed O&M (2015€/MWp/y)	12,200	10,400	8,400	7,100	R	3, 10
Fixed O&M (2015€/MW/y)	13,420	11,440	9,240	7,810		

Commercial PV systems with a typical plant capacity of 50–500kW, typically installed on residential, office or public buildings.

Technology	Photovoltaics: LARGE scale utility systems					
	2015	2020	2030	2050	Note	Ref
Input						
Global horizontal irradiance (kWh/m2/y)	1,068	1,068	1,068	1,068	A2	4
Energy/technical data						
Typical capacity for one installation (kW)(plant capacity)	4,000	4,000	4,000	4,000	B3	
Typical peak capacity for one installation at STC (kWp)	5,400	5,400	5,400	5,400	C	
Energy/technical data - system design						
DC/ACMAX sizing factor (Wp/Wac)	1.35	1.35	1.35	1.35	D	31
Transposition Factor for fixed tilt system	1.15	1.15	1.15	1.15	E	31
Incident Angle Modifier Loss (%)	3.0%	2.5%	1.5%	1.0%	F	13
PV systems losses and non-STC corrections (%)	13.0%	9.0%	7.0%	5.0%	G	
Inverter loss (%)	3.1%	2.6%	2.6%	2.1%	H, H2	13
AC grid losses (%)	1.0%	1.0%	1.0%	1.0%	I	
PV module conversion efficiency (%)	16.50%	19.0%	23.0%	26.0%		13
Availability (%)	100%	100%	100%	100%		
Technical lifetime of total system (years)	30	35	40	40		
Inverter lifetime (years)	10	15	15	15		
Output						
Full load hours (kWh/kWacmax)	1,340	1,420	1,460	1,510	L	
Peak power full load hours (kWh/kWp)	994	1,050	1,080	1,120	K, L	
Financial data (in 2015€)						
PV module (2015-€/Wp)	0.62	0.26	0.19	0.13	M2,Q2	31
Inverter and transformer (2015-€/Wp)	0.10	0.05	0.03	0.02		31
Balance Of Plant , mark-up & contingency cost (2015-€/Wp)	0.36	0.31	0.29	0.26	M2,Q2	31
Specific investment, total system (2015-€/Wp)	1.08	0.62	0.51	0.41	M2,Q2,N	31
PV module cost (€/Wacmax)	0.84	0.35	0.25	0.17		31
Inverter and transformer(€/Wacmax)	0.07	0.06	0.05	0.03		31
Balance Of Plant , mark-up & contingency cost (€/Wacmax)	0.49	0.42	0.39	0.35		31
Specific investment, total system (€/Wacmax)	1.46	0.83	0.69	0.56		31
Fixed O&M (2015-€/MWp/y)	9,500	8,100	6,500	5,500	Q2, R2	31
Fixed O&M (2015-€/MWacmax/y)	12,800	10,900	8,800	7,400	M2,Q2	

Data applies to utility PV installation typically mounted on the ground, with capacity of 1 MWp and larger, a maximum capacity limit is not indicated as solar systems are largely modular and the costs thus largely proportional to the size of the plant when the plant is larger than app. 1 MW

Notes:

A. The global irradiation is a measure of the energy resource potential available and is dependent on geographical location. The average value in Denmark as determined among 25 measurement stations is 1068 (kWh/m²/y) ± 3.1 %. The best sites demonstrate values around 1100 kWh/m²/y.

B. The area requirements decrease as the efficiency increases.

B1. 6.3 kWp corresponding to a panel area of approximately 25-40 m².

B2. 110 kWp corresponding to a panel area of approximately 400 – 700 m².

B3: In 2017 a PV-plant with require an area of around 1.3 to 1.7 ha/MWp assuming a module coverage of 35% to 45% and panel size of 1.64 m² for 275 Wp.

C. The peak power of the system is the max. power of the PV modules (DC).

D. The DC/AC shown equals module peak capacity (in Wp) divided by inverter/ transformer capacity(W_{ac,max}). The sizing factor is set to the same value for all years. In practice the sizing factor is chosen according to the desired utilisation/loading of the inverter which can also reflect a desire to maximise the energy production from a given (restricted) AC-capacity.

E. The transposition factor describes the increase in the sunlight energy that can be obtained by tilting the module with respect to horizontal and reduction in received energy when the orientation deviates from South. The TF factor is set to the same value for all years and sizes of the system, as it is not the technical factors of the system, which determine the TF.

F. The Incident Angle Modifier (IAM) loss represents the total yearly solar energy that is reflected from the glass when the angle of incidence is different from the perpendicular (the reflections at a normal incidence is already included in the STC efficiency).

G. These losses are calculated by simulating a model-year where corrections are made hour-by-hour due to the fact that the actual operation does not take place under STC conditions. Additionally, electrical losses in cables and combiner boxes are included.

H. The inverter loss includes the Maximum Power Point Tracking (MPPT) efficiency and is averaged over typical load levels.

I. Not relevant for small and medium size plants.

K. Also known as the specific yearly energy production (kWh/kWp) of the PV modules. This value is calculated from this formula: Peak power full load hours = Global horizontal irradiance * (*panel area/PV module conversion efficiency*) * transposition factor * (1-incident angle modifier loss) * (1-PV system losses etc.) * (1-inverter loss) * (1-AC grid loss). (*Panel area / PV module conversion efficiency*) is per definition 1 and can be omitted of the equation.

L. Capacity factor = Full load hours / Total number of hours per year (8760 h/y).

M. for roof placed PV the 2015 figure, is first published in 2015, the reference is market prices for PV in 2012/ 2013[7] and in 2014 [19] and it show that the marked prices for PV systems in Denmark were lower than prices found in international studies [3,18], and the prices have been stable or have increased from 2012/2013 to 2014. Therefore the investment in 2015 was assumed to be at same level as in 2012/2013 and 2014. In 2018 investment cost for the system and specific cost of PV panels are found in based on information from international importers and from national sales representatives and installers. In addition, international references ([27], [29]) have been consulted. The investment cost estimates for the system 2020 is based these findings.

M2. Market prices for utility scale PV systems have been estimated based on interviews with Danish developers and an assesment of the prices from Danish and Germany tenders for PV capacity in 2016 and the beginning of 2017. The price analysis is available in the note (in Danish) "Opdatering af teknologikatalogets solcelledata oktober 2017" [31](ref 31).

N. The financial values have been discounted as shown in the table below

Real prices	2015	2016	2017	2018	[LOFT21-prediction from the Danish Finance Act 2018 (FLL18 November 2017)]
BTV for price year (2015) estimated in 2018	1.000	1.002	1.014	1.030	

Q. Cost prognoses for PV panels in 2030 and 2050 are made keeping the relative difference to the cost for utility scale PV panels constant.

Q2. The prices analysis also contains a forecast of the PV cost in 2020, 2030 and 2050, which based on learning rates for the module and investor (20 % learning rate)and a projection of the cumulated PV capacity based on the IEA's 450 ppm scenario.

For the balance of plant (BoP) a more moderate cost projection is used, assuming that the cost drops by 1% per year until 2020, by 0.75% p.a. between 2020 and 2030 and then by 0.5% p.a. from 2030 to 2050

R. The cost of O&M includes insurance and regular replacement of inverters. The O&M cost for rooftop PV is calculated, assuming that the relation between the cost of O&M for rooftop PV and for utility scale PV is constant from 2015 to 2050. Note that the O&M costs for plants in Denmark are assumed significant lower than international estimates in [27] and [29].

R2. The cost of O&M includes insurance and regular replacement of inverters and land-lease. The cost of land lease amounts in 2017 to approx. 25% -30% of the fixed O & M cost. As the efficiency of the new solar panels increases, the required area per MWp will be lower. The same development is assumed for other O & M expenses.

S. The investment prices for PV systems in 2020, 2030 and 2050 are based on information from international importers and from national sales representatives and installers. In addition, international references ([27], [29]) have been consulted.

References

1. [NPD Solarbuzz PV Equipment Quarterly report, July 2013.](#)
2. [IEA PVPS Trends 2013 in Photovoltaic Applications – 2014 Edition, 2014/05/06 p. 53.](#)
3. [IEA, "Energy Technology Perspectives. Technology Roadmap: Solar Photovoltaic Energy, 2014 edition", OECD/International Energy Agency, 2014.](#)
4. Peter Riddersholm Wang, DMI Teknisk Rapport 13-08, Referenceværdier: Måned- og årsværdier for stationer 2001 - 2010, Danmark for temperatur, relativ luftfugtighed, vindhastighed, globalstråling og nedbør.
5. [M.J. \(Mariska\) de Wild-Scholten. "Energy payback time and carbon footprint of commercial photovoltaic Systems". Solar Energy Materials & Solar Cells 119 \(2013\) 296–305.](#)
6. "Solceller. Dansk strategi for forskning, udvikling, demonstration og udbredelse" (Solar cells. A Danish strategy for research, development, demonstration and deployment), Danish Energy Agency, Energy Technology Development Programme (EUDP), and Energinet.dk, 2009.
7. Prices from; Solcellepriser.dk, pricelist small plants 15 cheapest plants used,
8. EIA report: "Levelized Cost of New Generation Resources" in the Annual Energy Outlook 2013, U.S. Energy Information Administration, January 2013.
9. P. Ahm and J. Vedde, "Large Scale PV Plants – Also in Denmark". Project report, 2011.
10. IEA-ETSAP and IRENA Technology Policy Brief E11, January 2013.
11. Ubiquity Solar Inc. 2012, Extrapolation of PV module experience curve.
12. Pierre Verlinden. Trina Solar SKL presentation April 16th 2013.
13. IRTPV. International Technology Roadmap for Photovoltaic, Results 2013. March 2014.
14. [Thibaut Lemonie. Assessing the real quality of PV modules. Photovoltaics Int. Aug 2011, p. 177.](#)
15. M. Bolinger and S. Weaver. Utility-Scale Solar 2012. Lawrence Berkeley National Laboratory. September 2013.
16. IEA PVPS Task 14 reports.
17. [HOFOR plan, plant in Guderup \(websearch\) and 2 other plants \(anonymous, Jan Vedde 2014\) all four large and DK.](#)
18. David Feldman et al. Photovoltaic System Pricing Trends, Historical, Recent, and Near-Term Projections edition 2014. SUNSHOT U.S. Department of Energy, National Renewable Energy Laboratory and Lawrence Berkeley National Laboratory, September 22, 2014
19. Websearch by Jan Vedde November 2014 Prices for seven small plants for sale in DK in November 2014,
20. <http://www.photovoltaik-guide.de/pv-preisindex>, "Photovoltaik-preisindex" PV system up to 100 kWp, average 2014.
21. [Prices for nine large and medium size systems 2013-2014\(Confidential\).](#)
22. Gaia solar, BIOFOS Rensningsanlæg Damhusåen, large system 2013.
23. Gaia solar general offer 250 kW system 2014.
24. Anonym DK EPC#1 offering 0.91 2014-€/Wp for MW projects in DK
25. Anonym DK EPC#1 offering 0.95 2014-€/Wp for MW projects in DK
26. Sales representatives from 5 suppliers (in random order):
 - o *Changzhou EGing Photovoltaic Technology Co., Ltd.*,
 - o *China Sunergy (Nanjing) Co.,Ltd*,
 - o *Trinasolar*,
 - o *ZNSHINE PV-TECH CO., LTD.*
 - o *Elkem Solar*
- 27: Renewable Power Generation Costs in 2017, IRENA, januar 2018
28. Solar-installation companies' websites 1.-5. March 2018:

<https://www.vivaenergi.dk>

<https://xn--billigtsolcelleanlg-2xb.dk>

<https://klimaenergi.dk>

29. Cost development of low carbon energy technologies, Scenario-based cost trajectories to 2050, 2017 edition, Tsiropoulos, I. Tarvydas, D., Zucker, A. January 2018

30. [LOFT21-prediction from the Danish Finance Act 2018 (FFL18 November 2017)]

31. Ea Energy Analyses, Danish Energy Agency and Energinet.dk. "Opdatering teknologikatalogets solcelledata", June 2017.

23 Wave Energy

There are no plans to update this chapter.

This chapter has been moved from the previous Technology Data Catalogue for Electricity and district heating production from May 2012. Therefore, the text and data sheets do not follow the same guidelines as the remainder of the catalogue.

Brief technology description

A wave power converter comprises a structure interacting with the incoming waves. The wave power is converted by a Power Take-off (PTO) system based on hydraulic, mechanical or pneumatic principles driving a rotating electrical generator producing electricity or by a linear generator directly driven by the structure.

Numerous concepts are under development. Most of them can be classified according to three categories (ref. 2):

A *point absorber* is a floating device, moved up and down by the waves, typically anchored to the sea floor.

A *terminator* is a structure located perpendicular to the wave movement, 'swallowing' the waves

An *attenuator* is placed in the wave direction, activated by the passing waves.

There is no commercially leading technology on wave power conversion at the present time. However a few different systems are presently at a stage of being developed at sea for prototype testing or developed at a more fundamental level including tank testing, design studies and optimisation.

Input

Energy in ocean waves.

The energy content along Europe's Atlantic coasts is typically 40-70 kW/m. The wave influx in the Danish part of the North Sea is 24 kW/m farthest West, 7 kW/m nearer the coast, in average about 15 kW/m. The inner seas are irrelevant with only 1 kW/m (ref. 2).

The annual variation is normally within +/- 25%, while the seasonal variation is around 5:1, with highest potential during winter (ref. 2).

Output

Electricity.

Some systems are designed to pump water and produce potable water.

Typical capacities

The electrical output from wave power converters in some cases are generated by electrical connected groups of smaller generator units of 100 – 500 kW, in other cases several mechanical or hydraulically interconnected modules supply a single larger turbine-generator unit of 1 – 3 MW. These sizes are for pilot and demonstration

projects. Commercial wave power plants will comprise a large number of devices, as is the case with offshore wind farms.

Regulation ability

The ability to regulate the system operation depends on the design of the PTO system. In general the systems are developed with the aim of regulating the system to absorb most of the incoming waves at a given time, but also to enable disconnection of the system from the grid if required for safety or other reasons.

Wave power is more predictable compared to wind power and the waves will continue some time after the wind has stopped blowing. This could help increase the value of systems with combined wind and wave power.

Advantages/disadvantages

Advantages:

- Wave power converters produce power without the use of fossil fuels.
- The power plants are located in the ocean without much visual intrusion.
- Wave power is a more predictable resource compared to wind.
- Extracting energy from waves can help coastal protection, as the wave heights are reduced

Disadvantages:

- The initial prototype development at sea is costly and the successful development to reach costs comparable with i.e. off shore wind will require dedicated development programmes and substituted electricity prices until the technology has matured.
- In Denmark, the largest wave energy resource is found 150 km from the shore, making grid connection only feasible for large wave energy farms.
- Wave power converters, albeit at sea, take up large amounts of space, much dependent on type of converter and how much power is extracted. It is too early to tell, whether wave power will require more or less space than offshore wind power (ref. 7).

Environmental aspects

As for wind-energy a positive life cycle impact is expected. Planned in cooperation with navigation, oil exploitation, wind farms and fishing industry wave power plants are expected to have a positive impact on the living conditions for fish in the sea, by providing sheltered areas.

Research and development

The most recent Danish R&D strategy (ref. 3) has three focus areas:

- Continue the development and demonstration of concepts that have already proven a technical and economical potential.
- Support R&D in new concepts with promising perspectives.
- Evaluate most feasible sites, assess ways of safe anchoring, and determine how wave energy is best integrated into the Danish electricity system.

Examples of best available technology

It is too early to define best available technologies, since numerous technologies are being tested and demonstrated. Recent reviews have identified about 100 projects at various stages of development, and the number does not seem to be decreasing. Most concepts are described in ref. 5. This includes the most mature Danish technologies: Wave Star, Wave Dragon, Poseidon Floating Power Plant, Waveplane, Dexa.

By 2009, several plants with an individual turbine/generator capacity of up to 0.7 MW have been demonstrated (ref. 6).

Scotland and Portugal are very active in developing wave energy. Portugal had a goal of having 23 MW capacity installed by end of 2009. The first plant consisted of 3 Pelamis wave devices (www.pelamiswave.com), each 750 kW, installed in 2008 (ref. 1 and 2). However, due to financial problems for one of the investors, the plant was not in continuous operation end of 2009 (ref. 4).

National targets in Europe (ref. 9):

United Kingdom:	0.3 GW in 2020
Ireland:	0.5 GW in 2020
France:	0.3 GW in 2015
Spain:	0.2 GW in 2015
Portugal:	0.3 GW in 2020

Additional remarks

A cost breakdown of a typical mature ocean energy project is as follows (ref. 1):

Site preparation:	12%
Civil works:	55%
Mechanical and electrical equipment:	21%
Electrical transmission:	5%
Contingencies:	7%

Such a breakdown depends much on the chosen system and ocean location i.e. water depth and distance to shore. Energinet.dk has developed a spreadsheet to estimate the cost of energy (ref. 8).

References

- [1] "Energy Technology Perspectives 2008", International Energy Agency, 2008.
- [2] "Ressourceopgørelse for bølgekraft i Danmark" (Wave energy resources in Denmark), Aalborg University for the Danish Commission on Climate Change Policy, May 2009.
- [3] "Bølgekraftteknologi. Strategi for forskning og udvikling" (Wave power technologies. Strategy for R&D; in Danish); Danish Energy Agency and Energinet.dk, June 2005.
- [4] Aalborg University, Department of Civil Engineering, November 2009.
- [5] International Energy Agency Implementing Agreement on Ocean Energy Systems (IEA-OES; www.iea-oceans.org), Annual Report 2008.

- [6] “State of the art analysis”, status report of the Waveplam project, February 2009.
www.waveplam.eu/files/downloads/SoA.pdf
- [7] DONG Energy, December 2009.
- [8] www.energinet.dk/DA/KLIMA-OG-MILJOE/Energi-og-klima/Forskning-i-vedvarende-energi/Sider/Boelgekraft.aspx
- [9] www.eu-oea.com/euoea/files/ccLibraryFiles/Filename/000000001047/Cover%20letter%20position%20paper_merged.pdf

Data sheet

	Wave Power					
	2015	2020	2030	2050	Note	Ref
Energy/technical data						
Generating capacity for one power plant (MW)	1.0 - 30	2.0 - 50	10 - 100	50 - 500		1;1;4;4
Length of installation of one power plant km	0.2 - 2	0.2 - 5.0	1 - 20	5 - 100		1;1;4;4
Annual generated electricity production (MWh/MW)	1500	2500	3500	4500		4
Availibility (%)	90	95	97	98		4
Technical lifetime (years)	10	20	25	30		4
Construction time	3 - 4	3 - 4	3 - 4	3 - 4	C	4
Financial data						
Nominal investment (M€/MW)	4.6-11	3.8-9.0	2.2-4.5	1,6	A+B	2;2;2;3
O&M (€/MWh)	20	15	10	7		4
O&M (€/kW/year)	85			47		3

References

- [1] Wave Net final report, Project no. ERK5 – CT –1999-20001 (2000 - 2003)
- [2] “Energy Technology Perspectives 2008”, International Energy Agency, 2008.
- [3] “Energy Technology Perspectives 2010”, International Energy Agency, 2010.
- [4] Danish Wave Energy Association, 2012

Notes:

- A The cost presented provides an estimate for what capital cost and operating costs of wave power converters might be in the future assuming all R&D challenges have been overcome, that economics of scale have been realized and that efficiencies in production and operation due to the learning curve effect have been achieved.
- B Cost data are the same as in the 2010 catalogue, however inflated from price level 2008 to 2011 by multiplying with a general inflation factor 1.053
- C Much dependent on plant size and location.

40 Heat pumps

Contact information:

Danish Energy Agency: Rikke Næraa, rin@ens.dk

Energinet.dk: Rune Grandal, rdg@energinet.dk

Author: Morten Hofmeister, PlanEnergi, mh@planenergi.dk

Publication date

August 2016

Amendments after publication date

Date	Ref.	Description
January 2018	40 heat pumps	Updated prices for auxiliary electricity consumption in data sheet

Qualitative description

Brief technology description

Heat pumps employ the same technology as refrigerators, moving heat from a low-temperature level to a higher temperature level. Heat pumps draw heat from a heat source (input heat) and convert the heat to a higher temperature (output heat) through a closed process; either compression type heat pumps (using electricity) or absorption heat pumps (using heat; e.g. steam, hot water or oil).

An important point regarding heat pumps is the ability to “produce” both heating and cooling. Hence, the “product” of a heat pump can be both heating and cooling – and at the same time.

When applied with the primary purpose of cooling, the cooling demand defines the capacity. When installed for cooling the heat pump will typically be the only cooling source, whereas when installed for heating it will in many cases be in combination with other sources that can provide the heat energy (e.g. at a district heating plant). However, the primary purpose of the heat pumps in the technology catalogue is heating. In this chapter the unit MW is referring to the heat output (also MJ/s) unless otherwise noted.

Heat pumps are utilized for industrial processes, individual space heating and district heat production.

The application of large heat pumps in district heating systems in Denmark may influence the development of the heat pumps globally – both the technology itself and the application. This is in opposite to the small scale heat pumps, where the Danish market is small compared to other markets, and therefore is not expected to influence the development of small scale heat pumps.

Compression heat pumps

For compression heat pumps, the practical heat output is usually 3 to 5 times (the coefficient of performance (COP)) the drive energy. This factor depends on the efficiency of the specific heat pump, the temperature of the heat source and the heat sink and the temperature difference between heat source and heat sink. The energy flow is illustrated in the Sankey diagram in figure 1 below:

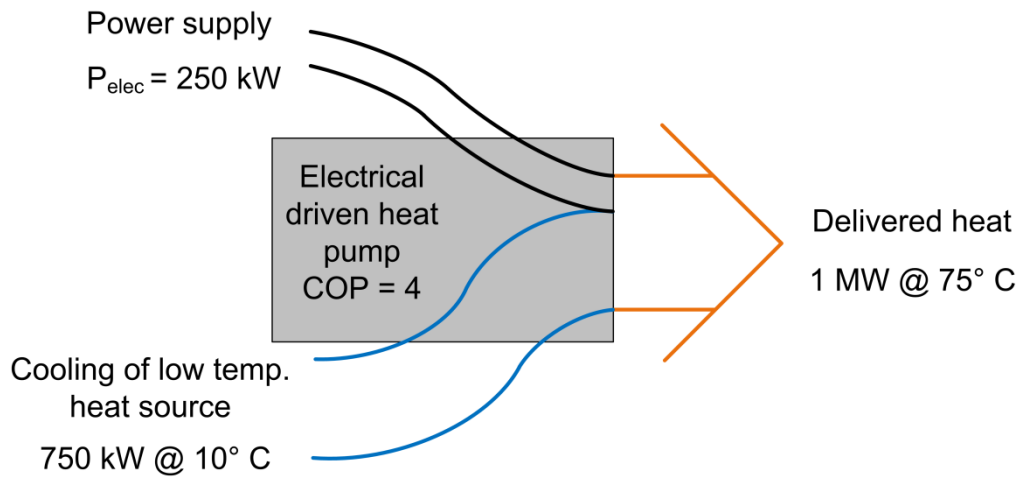
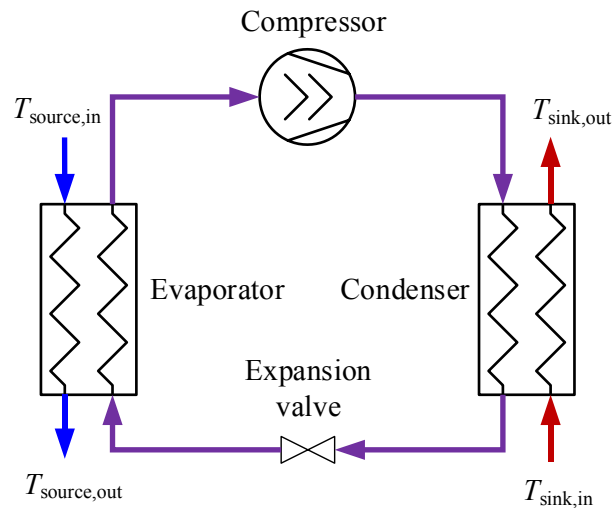

Figure 1: The electrical power consumption of 250 kW enables the heat pump to utilize 750 kW from a low temperature heat source at 10° C. Thus delivering 1 MW at 75° C (COP is 4).

The theoretical coefficient of performance can be calculated as the “Lorenz COP” which relates mechanical work to temperature differences in power generation, refrigeration and heat pump technology.



$$\text{COP}_{\text{Lorenz}} = \frac{T_{\text{lm,sink}}}{T_{\text{lm,sink}} - T_{\text{lm,source}}}, \quad \text{where} \quad T_{\text{lm}} = \frac{T_{\text{in}} - T_{\text{out}}}{\ln\left(\frac{T_{\text{in}}}{T_{\text{out}}}\right)}$$

Figure 2: Sketch of the heat pump cycle with components. The Lorenz COP is the theoretical maximum. (Source: Original figure from Bach (2014) "Integration of heat pumps in Greater Copenhagen").

A heat pump for district heating that heats water from 45 to 85° C (district heating) and cools a source from 20 to 15° C (cooling water from a factory), will have a theoretical maximum Lorenz COP of around 7.1.

In practice the COP will be lower due to mechanical and thermal losses, typically around 40-60 % of the theoretical COP. The relation between practical and theoretical COP depends on component efficiencies, heat exchangers, refrigerants and more. All COP-values stated in this document are practical values if nothing else is stated.

Possible practical COP values for large scale heat pumps are shown in figures 3, 4 and 5 below. The figures show the possible span of COP-values (max. and min. i.e. 40% and 60% losses) depending on the delivery temperatures in the system. The values are calculated with a heat source that is cooled 5° C – e.g. a heat source of 30° C is cooled to 25° C. Increasing the cooling of the heat source will lead to a lower COP, but a higher capacity.

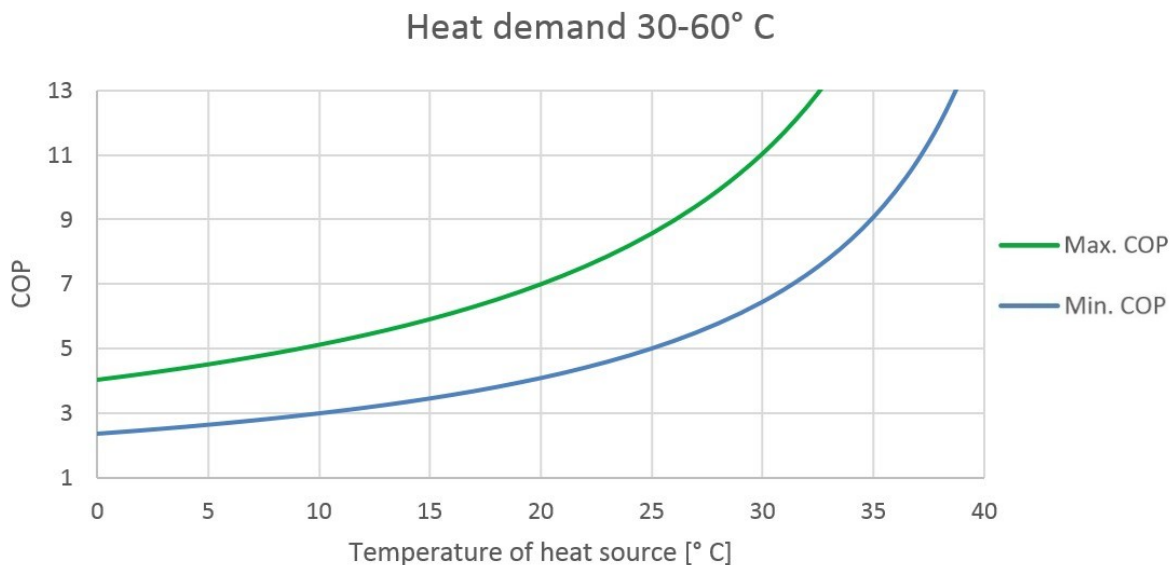

Figure 3: COP values of compression heat pump heating water from 30 to 60° C. For a heat source @ 0° C that is cooled to -5° C typical COP values will be 2.4-4.0 rising to 6.5-11 for a heat source @ 30° C that is cooled to 25° C [1].

Heat demand 45-75° C

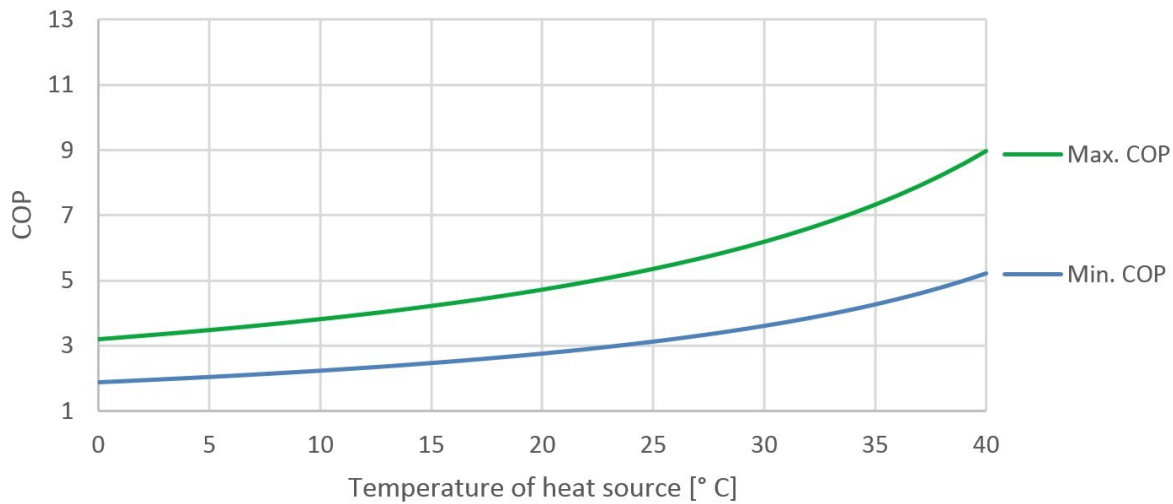

Figure 4: COP values of compression heat pump heating water from 45 to 75° C. For a heat source @ 0° C that is cooled to -5° C, typical COP values will be 2.0-3.1 rising to 5.0-9.0 for a heat source @ 40° C that is cooled to 35° C [1].

Heat demand 60-90° C

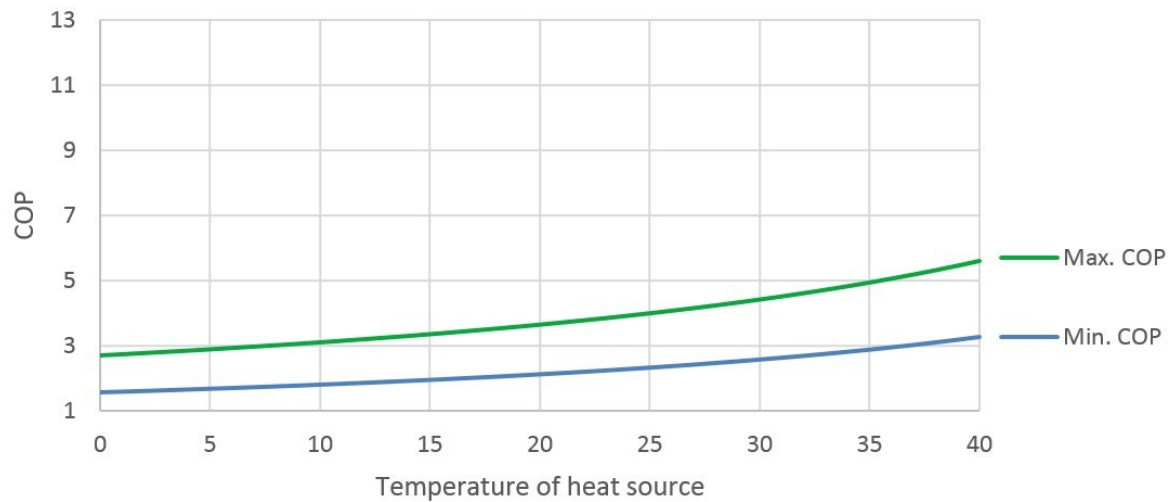

Figure 5: COP values of compression heat pump heating water from 60 to 90° C. For a heat source @ 0° C that is cooled to -5° C, typical COP values will be 1.6-2.7 rising to 3.2-5.6 for a heat source @ 40° C that is cooled to 35° C [1].

As the figures indicate, low temperature differences between source and sink are key to high COP values. Heat pumps are typically not profitable for high temperature heat demands where low temperature sources are utilized. Hence such heat pumps are unlikely to be on the market.

Absorption heat pumps

In absorption heat pumps, high temperature heat is used to regenerate a refrigerant that can evaporate at a low temperature level and hereby utilize low grade energy. Energy from both drive heat and the low temperature heat source is delivered at a temperature in between. In theory 1 kJ of heat can regenerate around 1 kJ of refrigerant meaning that an absorption heat pump has a theoretical maximum COP of around 2. Due to losses in the system the practical COP is around 1.7. For absorption heat pumps, COP is not affected by temperature levels. Certain temperature differences is required to have the process going, but as long as these are met the COP will be around 1.7 and not affected by further temperature increase of the drive energy.

The energy flow is illustrated in the Sankey diagram in figure 6:

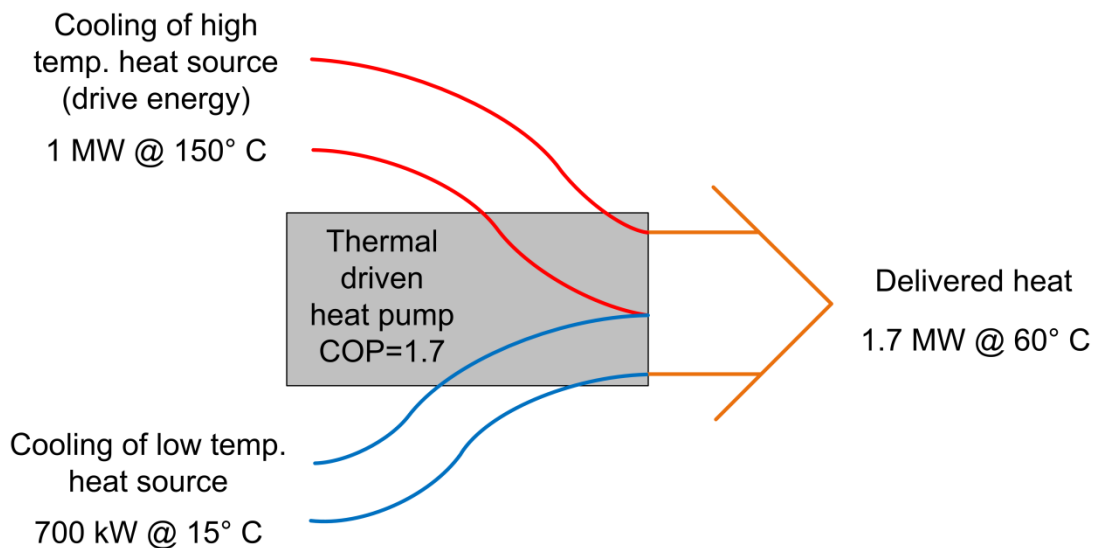

Figure 6: The high temperature drive energy of 1 MW enables the heat pump to utilize 700 kW from a low temperature heat source at 15° C. Thus delivering 1.7 MW at 60° C (COP is 1.7).

Two-stage versions are available for particular high driving temperatures. In two-stage absorption heat pumps, the drive energy is used twice enabling the heat pump to utilize almost twice as much low-grade energy. The practical COP of two-stage systems is typically 2.3.

Input

Inputs for heat pumps are a heat source and drive energy.

Heat sources can be ambient air, surface water or groundwater, ground (soil) or surplus heat from industries. Typical Danish temperatures are 0-18 °C as ambient air temperatures and 5-10 °C as groundwater temperature, whereas waste heat from industrial processes has much higher temperatures – sometimes enabling direct heat recovery. In some cases the input heat is delivered through a secondary water or glycol circuit but for optimum performance the heat source should be connected directly to the evaporator of the heat pump.

Drive energy for compression heat pumps are electricity (or engines consuming fuel), whereas absorption heat pumps are driven by heat; e.g. steam, hot water or flue gas, but also consume a small amount of electricity.

Output

The only output of a heat pump is heat. For large scale heat pumps the heat will typically be delivered to the end user through a water based distribution system.

The maximum delivery temperature differs according to type (compression or absorption heat pump) and also within either type depending on the actual refrigerant, design pressure and more. Most compression heat pumps will reach temperatures of around 80-90° C, whereas special types can reach up to 100-110° C. Absorption heat pumps are limited to around 85-87° C but the specific delivery temperature depends on the temperature of the heat source.

This is further outlined in the section “Development perspectives and future demand”.

Typical capacities

Large scale compression heat pumps that are utilized in Denmark are available in capacities of up to around 3-5 MW heat output. Depending on the delivery temperature, larger heat pumps of more than 3-5 MW will typically be a number of heat pump units in parallel. In other countries where HFC refrigerants are permitted in large systems it is possible to use turbo compressors meaning that heat pumps with a heating capacity of 25 MW or more exist.

Absorption heat pumps are available in capacities of up to around 12 MW of cooling. The heat output including drive energy will thus be around 20 MW.

Regulation ability and other power system services

Regulation ability is a topic currently being investigated in several projects.

As today’s market is very limited, large scale heat pumps are not constructed for very fast start/stop or load changes. Using adequate secondary water systems and control methods around the heat pump can enable most large scale heat pumps to fast starts and stops. In practice, the possibilities will depend on the specific heat pump construction and system requirements as outlet temperatures, efficiencies and more will be affected from fast load changes.

A frequency controlled heat pump has more components than on/off controlled heat pumps. This may increase the price.

Advantages/disadvantages

A general advantage of heat pumps is that the heat pump is able to recycle waste heat or utilize energy from the ambient which enables a utilization of heat sources otherwise left unused by conventional heat production technologies.

In energy systems where electricity plays a vital role, compression heat pumps can incorporate electricity in heating systems in an effective manner. For processes that are electrically heated, heat pumps reduce power consumption and load on the electrical grid.

Compression heat pumps that are electrically driven have no emissions from burning fuel, meaning that these systems can be installed in locations with restrictions on exhaust emissions.

Absorption heat pumps are able to utilize the energy quality of high temperature heat sources that are otherwise wasted when for instance a boiler is used to heat water up to 70 or 80 °C. In such applications, absorption heat pumps are able to exploit heat from the boiler at a higher temperature to recover heat from a lower temperature, thus reducing fuel consumption by approximately 40 %.

Compared to traditional heating technologies, heat pumps utilize a different working principle that is yet unfamiliar to parts of the heating industry. In order to reach the highest efficiencies, heat pumps are very dependable on low delivery temperatures and high temperatures of the source. This means that heat pumps are not suitable in all applications.

The heat source must be available and suitable according to the required heat demand. Changes in flow or temperature of the heat source will affect the performance of the heat pump, which can increase the complexity of a heat pump system.

Compared to most of the traditional heat production systems, heat pumps in general have higher investment costs, and lower energy consumption costs.

Environment

The primary environmental impact of heat pumps stems from the drive energy consumption and depends on the fuel type and production method. Absorption heat pumps are typically applied where fuel is already burned, meaning that the absorption heat pumps does not increase fuel consumption, but simply increase the heat output of an existing energy consumption.

As Danish legislation prevents synthetic refrigerants in circuits with more than 10 kg of refrigerant, heat pumps with a capacity of more than 60-80 kW utilize natural refrigerants meaning that toxicities from leaks are well known and greenhouse emissions from refrigerants are negligible.

Because of the Danish regulation, only natural refrigerants are utilized in Denmark. These are hydrocarbons (propane, butane and iso-butane), carbon dioxide, ammonia, and water vapour.

Ammonia is a widely applied natural refrigerant that can be dangerous to mammals and especially aquatic life forms. Because of this, ammonia systems must comply with certain safety measures regarding construction, location and operation. Other natural refrigerants are highly flammable but not environmentally harmful.

Research and development perspectives

In most countries the development within refrigeration moves towards natural refrigerants. The European F-gas regulation excludes the most harmful synthetic refrigerants and ensures that others are phased out during the coming years.

Danish regulation is even stricter by not allowing synthetic refrigerants in refrigeration units or heat pump installations holding more than 10 kg of refrigerant. Water vapor systems are not yet commercially available, but several demonstration projects are being initiated, meaning that low temperature systems will be demonstrated through the coming years. A new compressor type has been developed for cooling applications or as low stage circuit for heat pumps e.g. an H₂O system recovering heat from sea water at 0° C and delivering at 20° C, while an ammonia system takes the temperature from 20° C and delivers at a higher temperature. The technology has a number of advantages especially regarding utilization of low temperature water sources such as sea water, and is expected to play a vital role in large scale heat pumps for district heating.

Other areas of technology development are:

- Higher outlet temperatures
- Combinations of the different technologies, e.g., H₂O – NH₃ etc.
- Optimise the benefits for the overall electricity system of using heat pumps
- Intelligent integration in energy systems to increase overall system efficiency
- New control systems for higher flexibility and better system integration

Examples of market standard technology

Depending on size and temperature requirements, different types of heat pump technology can be the best choice and no single refrigerant is valid for all applications.

The best solutions are often multi-stage plants that will both cool and heat in steps to minimize thermal losses. Oil coolers, de-superheaters and subcoolers are utilized to minimize pressure differences and hereby the mechanical work required. High efficiency motors are applied, preferably cooled by water or refrigerant and heat from frequency converters are sometimes utilized as well.

As mentioned earlier the different refrigerants can be applied, depending on the specific requirements regarding temperature demand, capacity as well as practical issues.

CO₂ heat pumps operate in the so-called trans-critical pressure range, meaning that the refrigerant has a temperature glide on the warm side while the cold side evaporates at a constant temperature. This means that CO₂ is particularly suited in applications where heat is drawn from a low temperature source by cooling it only a few degrees, while the delivered heat is provided at a temperature glide of maybe 40° C. The maximum outlet temperature of CO₂ systems is app. 90° C. In order to obtain good COP values in CO₂ systems the inlet temperature of the heated media should not be higher than app. 40° C. Examples of installed plants using CO₂ as refrigerant:

Jensens Køkken, Denmark 200 kW – max. temperature of 80° C

Marstal Fjernvarme, Denmark - 1.5 MW – max. temperature of 75° C

Ammonia is a widely used refrigerant for industrial refrigeration meaning that large scale equipment with high efficiencies can be utilized for the heat pumps. Ammonia is typically used for the largest plants reaching up to

around 95° C utilizing special components for high pressure levels. Ammonia is also suitable for lower temperature levels where standard components are utilized meaning less investment cost and high COP values. Examples of installed plants using ammonia as refrigerant:

Drammen District Heating, Norway - 15 MW – max. temperature of 90° C

Skjern Paper Mill, Denmark – 4 MW – max. temperature of 90° C

Bjerringbro District Heating, Denmark, 3.7 MW – max. temperature of 70° C

Hybrid H₂O/NH₃ heat pumps combine the absorption and the vapour compression cycles, hence the name hybrid. Ammonia is used as refrigerant but absorbed by H₂O thus at reduced working pressure meaning that standard components can be used for high temperatures. The maximum temperature in systems in operation is around 90° C but it should be possible to reach higher temperatures using the same components. Examples of installed plants, hybrid using H₂O/NH₃ as refrigerant:

Nortura Dairy, Norway – 0.65 MW – max. temperature of 85° C

Arla Dairy, Denmark – 1.2 MW – max. temperature of 85° C

Hydrocarbons are primarily used in medium sized applications where either propane or isobutene is used as refrigerant. These refrigerants can be used with standard components from commercial refrigeration meaning that investment costs are kept at a low level. Propane can reach temperatures of 65° C whereas isobutene can reach temperatures of around 85° C. These refrigerants are flammable meaning that heat pumps are often delivered in a special cabinet and installed outdoors. Examples of installed plants using Hydrocarbons as refrigerant:

GKN Wheels, Denmark – 1.1 MW – Propane, max. temperature of 65° C

Birn, Denmark – 1.2 MW – Propane, max. temperature of 65° C

Skejby Sygehus, Denmark – 0.2 MW – max. temperature of 85° C

LiBr/Water is used in absorption heat pumps whereas ammonia/water is typically used in absorption cooling systems. Water is the refrigerant meaning that the gauge working pressure is negative. The lowest possible temperature on the source side is around 6° C while the sink temperature can be up to around 85° C. The different temperatures influence each other meaning that a low source temperature can limit the delivery temperature for the heat sink.

For higher temperature lifts, it is possible to buy absorption plants where two systems are built in to one and connected in series to increase the temperature lift. Examples of installed LiBr/Water plants:

Bjerringbro District Heating, Denmark, 0.9 MW (cooling) – max. temperature of 70 °C

Vestforbraending, Denmark – 13 MW (cooling) – max. temperature of 80 °C

Prediction of performance and costs

Learning curves express the idea that each time a unit of a particular technology is produced, some learning accumulates which leads to cheaper production of the next unit of that technology. Hence, there are two dimensions of learning curves; the application of the technology and the technology itself.

The technology development perspective has the same two dimensions; the application and the technology itself. Both dimensions influence the parameters including the efficiency of a heat pump in operation. The application dimension has a larger potential for improvement than the technologies themselves. The estimate of the development perspectives in the data sheets is the total potential, i.e. both dimensions.

With reference to the IEA “Innovation theory” describes technological innovation through two approaches: the technology-push model, in which new technologies evolve and push themselves into the marketplace; and the market-pull model, in which a market opportunity leads to investment in R&D and, eventually, to an innovation [2]. The level of “market-pull” is to a high degree dependent on the global climate and energy policies. Hence, in a future with strong climate policies innovation can be expected to take place faster than in a situation with less ambitious policies.

In Danish, European and to some extent also global contexts, there is increased focus on energy efficiency (Danish Energy Policy, European Energy Union and Energy Efficiency Directive). Heat pumps can be a tool to increase the energy efficiency. Therefore, a significant market-pull can be expected regarding heat pumps.

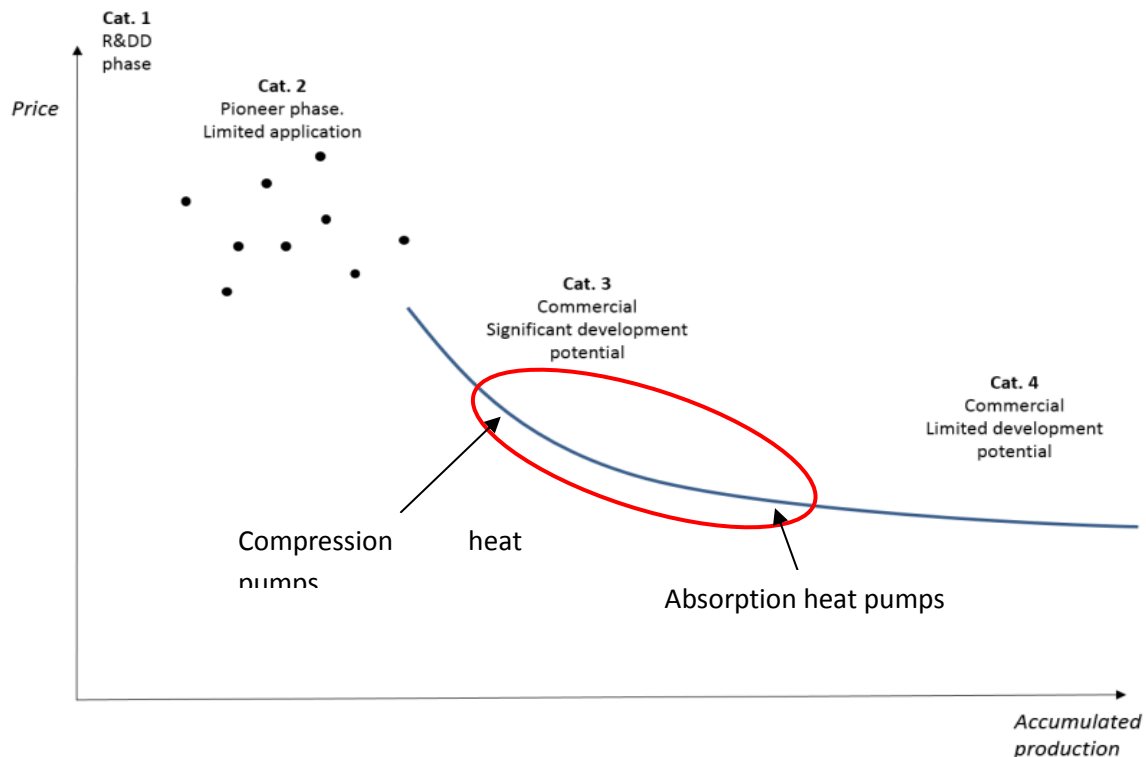

Figure 7: Learning curves of heat pumps for district heating production.

Large scale heat pumps belong in Category 3: “Commercial technologies with moderate deployment so far and significant development potential”. It is expected that there is a potential for reducing cost of large scale heat pumps. The potential for increased efficiencies of the heat pump itself is limited as the best large scale heat pumps are already very efficient. However it is possible to integrate heat pumps in a more effective manner and to improve the practical COP value. This could lead to installations with high COP values. Absorption heat pumps are more common than compression types, meaning that the development potential is lower.

Large scale compression heat pumps derive from industrial refrigeration applying the same principles and a lot of the same components. However, heat pumps require a higher working pressure meaning that some of the main components are special for heat pumps which limits the supply range. Large scale heat pumps are still rare compared to industrial refrigeration, meaning that the production numbers for certain components are low.

Most heat pump plants today are custom built requiring a high amount of engineering in each case. One reason being the low number of installed heat pumps. As more plants will be constructed, it is expected that engineering will be systemized and calculation tools will be developed to ensure swift specification and construction.

As stated above, the low production numbers of heat pumps leaves a potential for cost reduction. Ideally the prices could match equipment for industrial refrigeration in the future.

Absorption heat pumps are more widely spread and because of this, the potential of reduced investment costs are lower than for compression heat pumps. At the moment development primarily concerns size optimization (reduction of footprint), which is more of a barrier than investment cost.

Based on the above mentioned the following assumptions regarding accumulated volume and cost reduction for investment and maintenance for heat pumps are introduced.

Increase in accumulated produced units	2015-2020	2020-2030	2030-2050
Compression heat pumps	0,8	1,25	1,25
Absorption heat pumps	0,5	0,8	0,8

Table 1: Assumed increase in the accumulated produced units in the different time periods.

Reduction in cost	2015-2020	2020-2030	2030-2050
Compression heat pumps	6%	10%	10%
Absorption heat pumps	4%	6%	6%

Table 2: Resulting reduction in cost in the different time periods, it is for both types it is assumed that the cost is decreased 7-8% for every doubling.

Energy efficiency and COP

Regarding energy efficiency, the mechanical work of compression heat pumps relates to the temperature difference between heat source and sink. As stated in the first section, a theoretical COP can be calculated from the temperatures in the system, whereas an actual COP further relates to mechanical losses and thermal losses within the system. The difference between the theoretical and the actual COP value is the efficiency of a specific system.

As the practical efficiency depends on both mechanical and thermal losses, it is expected that the efficiency will only increase a few percentage points during the next years. It is however expected that heat pumps with higher COP values will be installed but this will be due to better system integration.

No matter how much the individual components are optimized, there will always be a large increase in the COP when energy is absorbed at the highest possible temperature and delivered at the lowest possible temperature.

Temperature differences can be reduced by optimizing the system (e.g. lowering temperatures in district heating systems), eliminating secondary circuits, utilizing multistage heat pump systems, coproduction with other heat production units etc. The significance of system temperatures is visualized on figure 3, 4 and 5.

Uncertainty

Future development of investment costs and performance is quite uncertain as these parameters are valued against fuel and electricity cost.

If electricity cost increase it would be profitable to buy a more expensive heat pump with better performance.

Costs of fuels affect the competitiveness of heat pumps. E.g. expensive biomass, gas or oil will imply that heat pumps will be better alternatives even with low COP values.

Hence, the competitiveness of heat pumps is not only determined by the improvement of efficiency of heat pump technology and installation, but also the development of efficiency of competing technologies, market prices, taxes and subsidies on energy sources including electricity.

One method to navigate in this uncertainty is to refer to official scenarios for the development of energy prices issued regularly by the Danish Energy Agency.

In a concrete project context uncertainty can be mitigated by applying the calculation tool developed in [3] which enables an initial assessment of the feasibility of a heat pump based on key data for a specific plant.

Economy of scale effects

The effect of economy of scale is limited for large scale heat pump plants. Due to limitations in component sizes, many components are often duplicated meaning that scale effects are limited. Capacity increase of 100 % typically increase price by 70-90 %.

Additional remarks

A key point regarding application of the data in the data sheet is that e.g. the practical COP may vary considerably depending on the specific temperatures.

The following types and sizes are covered in this technology sheet:

- Large heat pumps for district heating systems, heat source ambient temperature
- Large heat pumps for district heating systems, heat source 20°C
- Large heat pumps for district heating systems, heat source 40°C
- Large single effect absorption heat pumps

In the technology sheets, two tracks for the future district heating supply temperature are assumed, these are:

Assumed supply temperature in each track	2015	2020	2030	2050
Track: No development in supply temp.	40 – 80°C			
Track: Reduced supply temp.	40 – 80°C	40 – 75°C	35 – 70°C	30 – 60°C

Data sheets

Technology	40 Electrical compression heat pumps - district heating									
	2015	2020	2030	2050	Uncertainty (2020)		Uncertainty (2050)		Note	Ref
Energy/technical data	Lower		Upper		Lower		Upper			
Heat generation capacity for one unit (MW _{heat})	4	4	4	4	3	6	3	10		3
Total efficiency, net (%), name plate	N/A	N/A	N/A	N/A	N/A	N/A	N/A	N/A		
Total eff., net (%), annual average, ambient heat source, no dev. in supply temp.	350	360	380	410	350	380	350	450	A, F, J, K	4
Total eff., net (%), annual average, ambient heat source, reduced supply temp.	350	400	480	600	350	450	350	700	A, B, F, J	3, 4
Total eff., net (%), annual average, waste heat 20° C, reduced supply temp.	440	500	600	740	440	600	440	850	A, B, F, J	3, 4
Total eff., net (%), annual average, waste heat 40° C, reduced supply temp.	700	900	1,200	1,800	700	1,200	700	2,000	A, B, F, J	3, 4
Electricity consumption for pumps etc. (% of heat gen)	2	2	2	2	1	4	1	4	I, M	3
Forced outage (%)	0	0	0	0	0	1	0	1	G	3
Planned outage (weeks per year)	0.5	0.5	0.5	0.5	0	1	0	1	H	3
Technical lifetime (years)	25	25	25	25	15	30	15	30		3
Construction time (years)	0.5	0.5	0.5	0.5	0.3	0.7	0.3	0.7	C	
Space requirement (1000m ² per MW _{heat})	0.02	0.02	0.02	0.02	0.01	0.04	0.01	0.04		1
Regulation ability										
Primary regulation (% per 30 seconds)	10	10	10	10	10	25	10	30	D	3
Secondary regulation (% per minute)	20	20	20	20	20	40	20	40	D	3
Minimum load (% of full load)	10	10	10	10	10	10	10	10	D	3
Warm start-up time (hours)	0	0	0	0	0	1	0	1		3
Cold start-up time (hours)	6	6	6	6	1	12	1	12	E	8,10
Environment										
SO ₂ (g per GJ fuel)	0	0	0	0	0	0	0	0		
NO _x (g per GJ fuel)	0	0	0	0	0	0	0	0		
CH ₄ (g per GJ fuel)	0	0	0	0	0	0	0	0		
N ₂ O (g per GJ fuel)	0	0	0	0	0	0	0	0		
Financial data										
Nominal investment (M€ per MW _{heat})	0.70	0.66	0.59	0.53	0.50	1.00	0.50	1.00	A, L	
- of which equipment (%)	50	50	50	50	30	70	30	70		3
- of which installation (%)	50	50	50	50	30	70	30	70		3
Fixed O&M (€/MW _{heat} /year)	2,000	2,000	2,000	2,000	1,000	3,000	1,000	3,000		3
Variable O&M (€/MWh _{heat})	3.3	3.2	3.7	3.9	2.2	4.8	2.7	6.7		
- of which is electricity costs (€/MWh _{heat})	1.3	1.4	2.0	2.3	0.7	2.8	1.2	4.7	M	
- of which is other O&M costs (€/MWh _{heat})	2.0	1.8	1.7	1.6	1.5	2.0	1.5	2.0	F	3

Notes

- A. Actual development within COP optimization and reduced investment cost depends on the development in fuel and electricity prices.
- B. The large potential for higher COP factors is primarily caused by lower supply temperatures in the future (40-80 °C in 2015 and 30-60 °C in 2050)
- C. The development within construction time will depend on future production figures and standardization of plants.
- D. The regulation ability of large heat pumps will depend on the future markets for regulation services.
- E. Cold start of time is starting a heat pump where stand by heating has not been applied
- F. Operation at part load will usually increase COP but increase variable O&M costs
- G. May vary depending on availability of heat source
- H. May vary depending on specific type, heat source etc.
- I. The auxiliary electricity is not included in the total efficiency
- J. The total efficiency net annual average is calculated using the practical COP
- K. Average value for ambient heat sources. For air it will be lower and for sea and lake water it will be around the average value, whereas for groundwater the value will be higher. It is weighted so that the heat pump produces 60-70 % of the demand of the district heating system. The supply temperature from the heat pump is fairly constant, since it is mixed with water from other production units in the months with the highest heat demand, when the supply temperature in the network is typically increased.
- L. Including heat uptake and buildings
- M. The cost of auxiliary electricity consumption is calculated using the following electricity prices in €/MWh: 2015: 63, 2020: 69, 2030: 101, 2050: 117. These prices include production costs and transport tariffs, but not any taxes or subsidies for renewable energy.

Technology	40 Absorption heat pumps - district heating									
	2015	2020	2030	2050	Uncertainty (2020)		Uncertainty (2050)		Note	Ref
Energy/technical data	Lower Upper Lower Upper									
Heat generation capacity for one unit (MW_{heat}) (excluding drive energy)	12	12	12	12	12	20	12	30	A	13
Total efficiency, net (%), name plate	N/A	N/A	N/A	N/A	N/A	N/A	N/A	N/A		
Total efficiency, net (%), annual average	170	171	173	175	170	180	170	180	B	4
Electricity consumption for pumps etc. (% of heat gen)	1	1	1	1	1	3	1	3	E	3
Forced outage (%)	0	0	0	0	0	1	0	1	C	
Planned outage (weeks per year)	0	0	0	0	0	1	0	1	D	
Technical lifetime (years)	25	25	25	25	15	30	15	30		3
Construction time (years)	0,5	0,5	0,5	0,5	0,3	0,7	0,3	0,7		
Space requirement (1000m ² per MW)	0,01	0,01	0,005	0,005	0,005	0,01	0,005	0,01		
Regulation ability										
Primary regulation (% per 30 seconds)	N/A	N/A	N/A	N/A	N/A	N/A	N/A	N/A		
Secondary regulation (% per minute)	N/A	N/A	N/A	N/A	N/A	N/A	N/A	N/A		
Minimum load (% of full load)	10	10	10	10	10	10	10	10		
Warm start-up time (hours)	0	0	0	0	0	1	0	1		
Cold start-up time (hours)	0,5	0,5	0,5	0,5	0,25	2	0,25	2		
Environment										
SO ₂ (g per GJ fuel)	0	0	0	0	0	0	0	0		
NO _x (g per GJ fuel)	0	0	0	0	0	0	0	0		
CH ₄ (g per GJ fuel)	0	0	0	0	0	0	0	0		
N ₂ O (g per GJ fuel)	0,0	0,0	0,0	0,0	0,0	0,0	0,0	0,0		
Financial data										
Nominal investment (M€ per MW_{heat}) (excluding drive energy)	0,6	0,56	0,51	0,46	0,4	0,8	0,4	0,8	A	3
- of which equipment (%)	50	50	50	50	30	70	30	70		3
- of which installation (%)	50	50	50	50	30	70	30	70		3
Fixed O&M (€/MWh _{heat} /year)	2000	2000	2000	2000	1000	3000	1000	3000		3
Variable O&M (€/MWh _{heat})	0,9	1,0	1,3	1,4	1,0	2,5	1,4	0,3		
- of which is electricity costs (€/MWh _{heat})	0,6	0,7	1,0	1,2	0,7	2,1	1,2	0,0	E	
- of which is other O&M costs (€/MWh _{heat})	0,30	0,28	0,25	0,23	0,30	0,40	0,20	0,30		3

Notes

- A. The heat pump itself only represents a small part of the total investment. Depending on size the heat pump typically represents 0.2 M€ per. MW heating (excluding drive energy).
- B. The heat is assumed delivered at 80 °C in 2015 and 60 °C in 2050.
- C. May vary depending on availability of heat source.
- D. May vary depending on specific type, heat source etc.
- E. The cost of auxiliary electricity consumption is calculated using the following electricity prices in €/MWh: 2015: 63, 2020: 69, 2030: 101, 2050: 117. These prices include production costs and transport tariffs, but not any taxes or subsidies for renewable energy.

References

- [1] Teknologisk Institut, 2015.
- [2] Energy Technology Perspectives 2012, IEA, 2012.
- [3] Drejebog til store varmepumpeprojekter i fjernvarmesystemet, 2014. [Online]. Available: <http://www.planenergi.dk/varmepumper/>.
- [4] Udredning vedrørende varmelagringsteknologier og store varmepumper til brug i fjernvarmesystemer, 2013.
- [5] K. E. Herold, R. Radermacher og S. A. Klein, Absorption chillers and heat pumps, 1996.
- [6] Advansor, 2015.
- [7] Hybrid Energi, 2015.
- [8] Innoterm, 2015.
- [9] Cronborg, 2015.
- [10] Johnson Controls, 2015.
- [11] Udredning vedrørende varmelagringsteknologier og store varmepumper til brug i fjernvarmesystemer, 2013.
- [12] Energinet.dk, 2015.
- [13] Scandinavian Energy Group, 2015.

41 Electric Boilers

Contact information:

Energinet.dk: Loui Algren, loa@energinet.dk

Author: Morten Hofmeister, PlanEnergi, mh@planenergi.dk

Publication date

June 2017

Amendments after publication date

Date	Ref.	Description
June 17	41 Electric boilers	Chapter from previously catalogue revised and added
January 18	41 Electric boilers	Updated prices for auxiliary electricity consumption in data sheet

Qualitative description

Brief technology description

Electric boilers are devices in the MW size range using electricity for the production of hot water or steam for industrial or district heating purposes. They are usually installed as peak load units in the same way as an oil or gas boilers. Hence, the following description of electric boilers is based on an operation strategy, aiming at approx. 500 full-load hours/year.

The conversion from electrical energy to thermal energy takes place at almost 100 % efficiency. However, from an exergetical point of view, this technology should be justified by its systemic advantages. Cf. electric water heaters can be a part of the energy system facilitating utilization of wind energy and enabling efficient utilization of various heat energy sources.

Thus, the application of electric boilers in district heating systems is primarily driven by the demand for ancillary services rather than the demand for heat. Although, examples of electric boilers, that operate on the spot market can be found.

Generally, two types of electric boilers are available:

- Heating elements using electrical resistance (same principle as a hot water heater in a normal household). Typically, electrical resistance is used in smaller applications up to 1-2 MW. These electric boilers are connected at low voltage (e.g. 400 or 690 V, depending on the voltage level at the on-site distribution board).
- Heating elements using electrode boilers. Electrode systems are used for larger applications. Electrode boilers (larger than a few MW) are directly connected to the medium to high voltage grid at 10-15 kV (depending on the voltage in the locally available distribution grid).

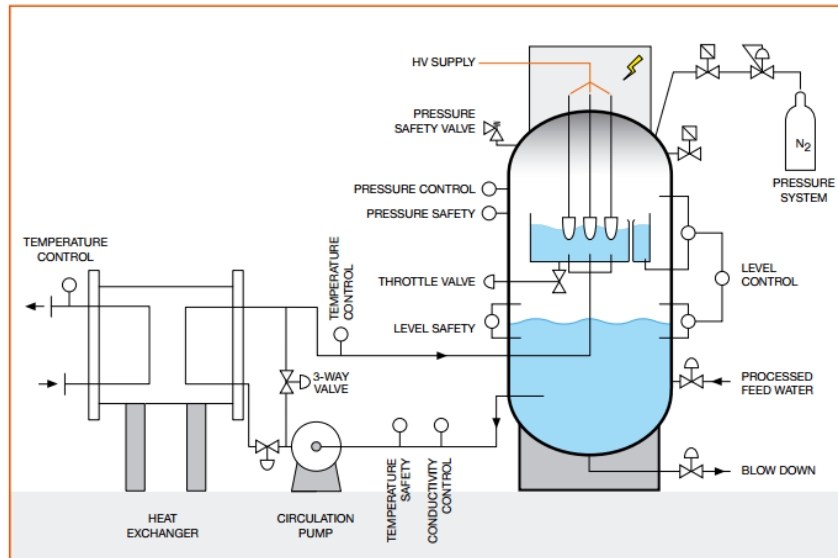

Figure 1: Schematic illustration of an electrode boiler. The heat is generated in the upper chamber through ohmic resistance between the electrodes. The boiler is pressurized with an inert gas system, e.g. nitrogen. [3]

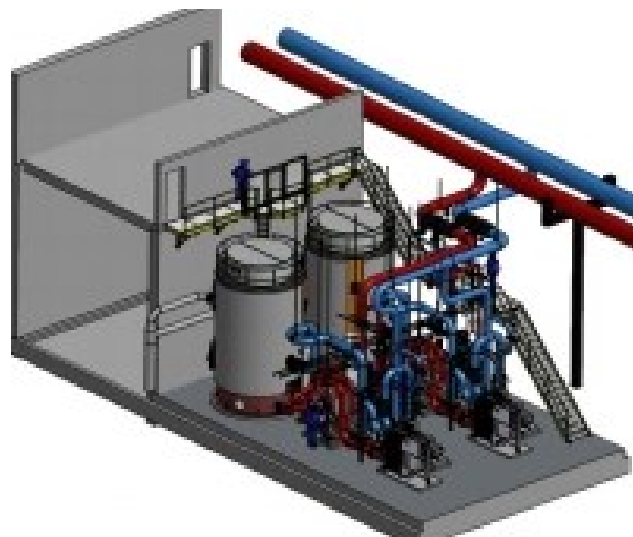

Figure 2: Illustration of 2x40 MW electric boilers installed at Studstrup power plant. The heat exchangers in front of the electric boilers transfer the heat from the water circuit in the boiler to the district heating circuit (blue/red piping). [9]

The water in electrode boilers is heated by means of an electrode system consisting of (typically) three-phase electrodes, a neutral electrode and a water level & flow control system. When power is fed to the electrodes, the current from the phase electrodes flows directly through the water in the upper chamber, which is heated in the process. The heat production can be varied by varying the flow through the upper chamber and the power that is led through, thus enabling output to be controlled between 0 and 100 %. [3]

In a similar technology, the heat output is varied, by varying the contact area between water and electrodes, by covering the electrodes in control screens. Thus the contact area between water and electrodes can be varied by varying the water level around the electrodes.

In both technologies, there will be no high-voltage consumption in a stand-by situation, as the only stand-by consumption is due to circulation pumps, which lies in the range of 5 % of full load.

Input

Electricity.

Output

Heat (hot water).

Typical capacities

Resistance-boilers are available in the span 6-5.000 kW/unit.

Electrode boilers are available in the seamless span 0-60 MW/unit, with typical appliances being 5-50 MW/unit.

Larger applications are typically a combination of multiple single units.

Space requirements

The net space requirements of electric boilers are in the range of 20-40 m²/unit with a total height of approx. 5-6.5 m. Examples of smaller units can be found as well. Furthermore, there is a space requirement of approx. 50-100 m²/appliance for heat exchangers, piping etc.

Regulation ability

Electric boilers can participate in up- and downward regulation. Modern electrode boilers have a minimal standby consumption when used as frequency-controlled reserves (down regulation). The standby consumption varies with the type of electric boiler. New electrode boilers of e.g. 12 MW have electricity consumption down to a few kW and no consumption at high voltage. Older types may have a standby consumption of 5-10 %. The above mentioned new generation of electrode boilers operate in such a way that the voltage is kept in the boiler, without applying any power. Using this technology, the only “stand-by consumption” is related to internal pumps and electric boilers can start with close to no standby consumption. Considering the close to none standby demand, many plants chose to keep the boiler operating in standby mode in order to be able to utilize the electrode boilers immediately when necessary.

Alternatively, it is possible to offer regulating power from cold start, hence eliminating the need for a standby consumption. This is made possible ramp up times of approx. 5 minutes in cold start situations, typically being shorter than necessary to participate on e.g. the power balancing market. However, due to the above-mentioned minimal standby consumption, operation on electrode boilers in standby is very common. The load shift from 0-100 % of nominal capacity is approx. 30 seconds. [8] [9]

Advantages/disadvantages

Advantages

Due to its very simple design, the electric boiler is extremely dependable and easy to maintain. The boiler has no built-in complex components, which may impede operation and maintenance. The boiler has quick startup and fast load-response. It requires no fuel feeding systems and no stack.

Disadvantages

As the input energy is electricity, the operating costs are subject to the variation in the electricity prices (market dependent) and the taxes on electricity. Electricity prices thus constitute a major part of the operation costs, without being the only factor to consider when evaluating the economy of operation.

In case electric boilers utilize power from thermal power production, exergetical losses will have to be considered in the evaluation of the total energy balance. Depending on the type of grid connection (full/limited), the availability of the electric boiler may be limited, as explained in the Brief technology description.

Environment

During operation, the electric boiler uses electricity and the environmental impact from operation depends on the origin of the electricity. Apart from the emissions, due to the consumed electricity, electric boilers have no local environmental impact.

Research and development perspectives

The technology is well developed, tested and commercially available. Future development will focus on dynamic use of electric boilers in connection with the power system. The development objectives are thus assessed to be limited to the dynamic application of electric boilers, according to the economic & legislative framework, rather than further development of the electric boiler itself. [8] [9]

Examples of market standard technology

Swedish boiler manufacturer Zander & Ingeström (ZVBA-boiler) [2] and Norwegian boiler manufacturer PARAT (Parat IEH) [3] produce state-of-the-art electrode boilers. Additionally, [7] comprises an overview of installed electric boilers in district heating systems in Denmark, including a map and a list of plants.

Technical aspects of applying electric boilers in district heating

The technical criteria for participating in the ancillary services of the Nordic electricity market vary in terms of the necessary start up times and the duration of activation. Participating with the early applications of electric boilers (built 2006-08) as manual frequency restoration or replacement reserves (mFRR / RR, start-up time: 15 minutes) could happen from a cold-start. Application as frequency containment reserves (FCR, start-up time: 30s) and automatic frequency restoration reserves for regulating power (aFRR, start-up time: 5 minutes) however required the electric boilers to operate in stand-by. From approximately 2010-12, many electrode boilers were modified, making it possible to ramp up from 0 % to 100 % of the nominal capacity within 30 seconds. Thus, the early boilers today have the same technical specifications in terms of start-up times and energy efficiency as the new built.

Most distribution system operators (DSO) choose to offer limited grid access for electric boilers, thus limiting the available electric capacity for the boilers in hours of high load. Having the possibility of full grid access at all times typically results in higher expenses for the grid connection, worsening the economy of the electric boiler project. Depending on the DSO and the grid situation, a minimum load can be negotiated.

Operating electric boilers in the Nordic electricity market

The economic framework of the Nordic electricity market is dynamic in terms of necessary capacities and traded volumes as ancillary services. The variation of bidding players results in further dynamics of the market framework, creating a continuously changing framework for electric boilers to be operated within [1] [4].

The first electric boilers in the district heating systems in Denmark were installed in 2006-2008. The design of the electricity market in this period created a promising framework for electric boilers in terms of availability payments in mainly the manual reserve (ramp-up time 15 minutes). This was followed by potentially high revenues from other reserve markets and the trading of regulating power in general. Together with other motives, this resulted in an increase of the installation of additional capacity to approximately 400 MW by the end of 2012 and approximately 490 MW by the end of 2015. Besides the described ancillary services, the transmission system operator (TSO) has the possibility to activate “special regulating energy” (Danish title: Specialregulering) if the stability of the grid makes this necessary. The use of this option has increased throughout 2014-15, mainly due to high penetration and design of subsidy schemes of wind power in Northern Germany. The activation of Danish electricity consumption proved to be a cost-effective way to integrate surplus wind power, with forced shut-downs of wind turbines being the alternative, cf. the curtailment of wind power regulation in Northern Germany in hours of high load [5].

The techno-economic application of electric boilers in district heating

Based on the above, investments in electric boilers have historically been partially driven by the chance of making a profit at the FCR market. Other arguments for the electric boilers, such as security of supply through the installation of electric boilers as peak and backup capacity are increasing in importance, as the yields from FCR are varying. Furthermore, electrode boilers constitute a promising option for thermal power plants to integrate the electrical output in minimum load operation situations. Thus, the electrical power can be used for heat generation instead of being fed into the grid in hours of negative spot prices.

Since 2012, there has been only one – very large – new application. The installation of 2x40 MW electric boilers at Studstrup CHP plant in Aarhus (2015) and an electrode boiler at Asnæsværket in Kalundborg with a total capacity of 93 MW (2002) are the biggest applications in Denmark yet. Furthermore, a 30 MW electric boiler was installed at a CHP plant of Silkeborg Forsyning.

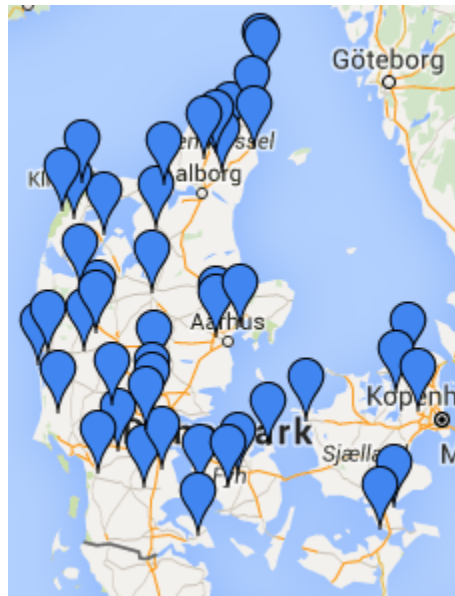

Figure 3: Overview of large installations in Denmark. The interactive map is available at [7]. A list of applications is available at the same web-site. 45 applications with a total of 490 MW. The largest applications are 80 and 93 MW (2015 and 2002 respectively).

List of suppliers of electric boilers:

- Aktive Energi Anlæg, www.aea.dk
- Tjæreborg Industri, www.tji.dk
- as:scan industries, www.scan-industries.com
- DWC, www.dwcsystems.com

Application of domestic scale electric boilers

In the small-scale range, household applications designed for ultra-low temperature district heating systems may serve as supplementing technology. The purpose is to top up the district heating supply to fulfil the hot tap water demand. This enables low temperature district heating implying reductions in heat losses and efficient utilisation of various low temperature heat sources (applying heat pumps with high COP). Small-scale electric water heaters (household application; approx. 5-30 kW) are subject to ecolabelling [6]. These units are described in another catalogue on individual heating technologies.

Prediction of performance and costs

Electric boilers are a mature technology. Further development is thus estimated to be limited to reductions in equipment costs, due to an increase in the volume of sales.

The likeliness of district heating companies to invest in electric boilers is dependent on revenues from e.g. the regulating power market and other flexible ways to offer (downward) regulating power as described above. A development potential is the (supposedly increasing) necessity for thermal power plants to operate in minimum load at low or negative electricity prices. As the above factors are subject to uncertainty, minimizing the planning security, no major development of electric boilers is expected. The development potential is

assessed to be related to the market shares of electric boilers only, as opposed to further technological development.

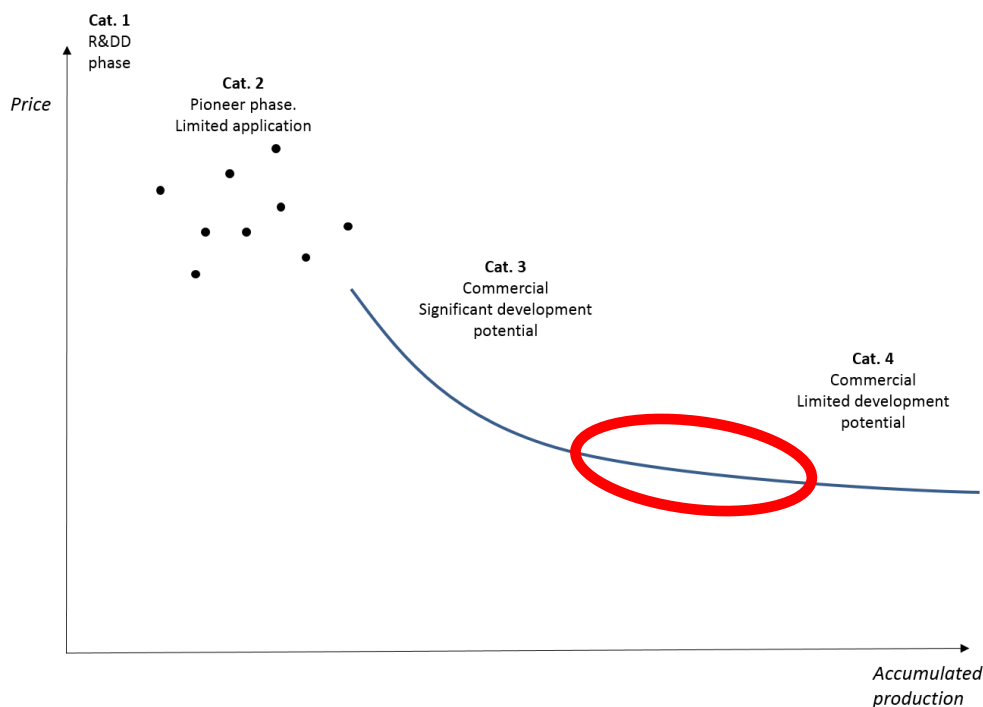

Figure 4: Technological development phases. Correlation between accumulated production volume (MW) and price. Electric boilers are to be placed between category 3 and 4, with the main development potential being related to a possible increased market penetration (“Commercial, limited development potential”).

Uncertainty

For electric boilers, the uncertainty is low, because electric boilers are categorized as category 3-4. It is assessed that there will be no major decreases in the equipment costs, as these would imply a strong increase in sales volumes (and vice versa).

Additional remarks

The operating costs of an electric boiler are highly dependent on the costs of electricity, i.e. the market price of electricity and currently applicable taxes and fees. Thus, heat production on electric boilers in e.g. a district heating plant can only compete with other heat production units at low electricity prices (e.g. in periods with high wind power production).

The number of full-load hours (heat) for electric boilers is assumed to be 500 according to the Guideline.

Data sheets

Technology	Electric boilers, 400 or 690 V, 0.06-5 MW; 10 or 15 kV, >10 MW									
Energy/technical data	2015	2020	2030	2050	Uncertainty (2020)		Uncertainty (2050)		Note	Ref.
					Lower	Upper	Lower	Upper		
Heat generation capacity for one unit (MW)	5				1	25	1	25		
Total efficiency, net (%), name plate	98	99	99	99	98	99	99	99		9
Total efficiency, net (%), annual average	98	99	99	99	98	99	99	99		9
Electricity consumption for pumps etc. (% of heat gen)	0.5	0.5	0.5	0.5	0.1	0.5	0.1	0.5		9
Forced outage (%)	1	1	1	1	0.5	1	0.5	1	E	9
Planned outage (weeks per year)	0.2	0.2	0.2	0.2	0.2	0.2	0.2	0.2	E	9
Technical lifetime (years)	20	20	20	20	20	20	20	20		9
Construction time (years)	0.5	0.5	0.5	0.5	0.5	1	0.5	1		9
Regulation ability										
Primary regulation (% per 30 seconds)	100	100	100	100	100	100	100	100		9
Secondary regulation (% per minute)	100	100	100	100	100	100	100	100		9
Minimum load (% of full load)	5									9
Warm start-up time (hours)	0.008									11
Cold start-up time (hours)	0.08									11
Financial data										
Nominal investment (M€ per MW), 400/690 V; 1-5 MW	0.15	0.15	0.14	0.13	0.10	0.25	0.10	0.25	A	9
- of which equipment	0.12	0.12	0.11	0.10	0.08	0.20	0.08	0.20	B	9
- of which installation	0.03	0.03	0.03	0.03	0.02	0.05	0.02	0.05	D	9
Nominal investment (M€ per MW); 10/15 kV; >10 MW	0.07	0.07	0.06	0.06	0.02	0.17	0.02	0.17	A	9
- of which equipment	0.06	0.06	0.05	0.05	0.02	0.14	0.02	0.14	C	9
- of which installation	0.01	0.01	0.01	0.01	0	0.03	0	0.03	D	9
Fixed O&M (€/MW/year)	1,100	1,070	1,020	920	1,000	1,100	900	1,000	A	9
Variable O&M (€/MWh)	0.8	0.9	1.0	1.0	0.5	0.9	0.5	1.0		9
- of which is electricity costs (€/MWh)	0.3	0.3	0.5	0.6	0.1	0.3	0.1	0.6	F	
- of which is other O&M costs (€/MWh)	0.5	0.5	0.5	0.4	0.4	0.5	0.3	0.5	A	9
Technology specific data										
Startup costs (€/MW/startup)	0	0	0	0	0	0	0	0		9

Notes:

- A The investment and O&M costs are assessed in relation to an approx. operation in 500 hours/year.
- B The installation at low voltage necessitates a transformer substation & expansion of the distribution board. Costs for these are included in the stated equipment costs.
- C Electrode boilers at medium-high voltage are directly connected to the distribution grid. Costs for the distribution board are included in the equipment costs.
- D The installation costs include costs for electrical integration & grid connection fees.
- E The forced outage of electric boilers is very limited and typically well below 1 %. The planned outage is typically limited to 1 day/year.
- F The cost of auxiliary electricity consumption is calculated using the following electricity prices in €/MWh: 2015: 63, 2020: 69, 2030: 101, 2050: 117. These prices include production costs and transport tariffs, but not any taxes or subsidies for renewable energy.

References

- [1] PlanEnergi, Teknologisk Institut, GEO & Grøn Energi, Review of thermal storage technologies and heat pumps in district heating systems [Danish title: "Udredning vedrørende varmelagringsteknologier og store varmepumper til brug i fjernvarmesystemet"], 2013
- [2] Zander&Ingström, homepage of electrode boiler manufacturer, www.zeta.se/boilers/en
- [3] PARAT, homepage of electrode boiler manufacturer, <http://parat.no/en/products/industry/parat-ieh-high-voltage-electrode-boiler/>
- [4] Parbo, H., Purchase of regulating power, special regulation and other power system services [Danish title: "Indkøb af regulerkraft, specialregulering og øvrige systemydelse"], Presentation at Dansk Fjernvarme, August 31st, 2015
- [5] Article (in Danish): Tyskland beder i stigende grad danske vindmøller om at stå stille. Available at: <http://www.energinet.dk/DA/El/Nyheder/Sider/Tyskland-beder-i-stigende-grad-danske-vindmoeller-om-at-staa-stille.aspx>
- [6] Draft commission decision of [...] establishing the criteria for the award of the EU Ecolabel for water-based heaters, draft version 5, July 2013. Available at: <http://www.ecolabel.dk/~media/Ecolabel/Files/Hoeringer/Blomstm%C3%A6rkede-tekstiler-madrasser-maling/Waterbased-heaters.ashx>
- [7] www.smartvarme.dk
- [8] BVA Elektrokessel, Personal Communication, 2016
- [9] Tjæreborg Industri, Personal Communication, 2016
- [10] Tjæreborg Industri, Personal Communication, 2015
- [11] Parat, unknown date, Brochure High Voltage Electrode Boiler, available at <http://parat.no/media/201154/Electrode-Boiler-web.pdf>

42 WtE HOP (go to chapter 08)

Due to large similarities, the qualitative description of waste-to-energy heat only and combined heat and power plants have been combined into one chapter, and can be found in chapter 08 WtE CHP and HOP plants.

Furthermore, a common qualitative description of waste-to-energy and biomass plants (chapters 08 and 09) are found in Introduction to Waste and Biomass plants.

43 Biomass Fired HOP (go to chapter 09)

Due to large similarities, the qualitative description of biomass heat only and combined heat and power plants have been combined into one chapter, and can be found in chapter 08 WtE CHP and HOP plants.

Furthermore, a common qualitative description of waste-to-energy and biomass plants (chapters 08 and 09) are found in Introduction to Waste and Biomass plants.

44 District Heating Boiler, Gas Fired

Contact information:

Danish Energy Agency: Rikke Næraa, rin@ens.dk

Energinet.dk: Rune Grandal, rdg@energinet.dk

Publication date

August 2016

Amendments after publication date

Date	Ref.	Description
January 2018	44 gas fired DH boiler	Updated prices for auxiliary electricity consumption in data sheet

Brief technology description

The fuel is burnt in the furnace section. Heat from the flame is transmitted via radiation (and convection) to the inner walls of the boiler and from there to the water to be heated. After the combustion part, the hot flue gasses are led through the convection parts of the boiler and heat is transmitted to the water to be heated.

Shell and flue gas tube type boilers are the most commonly used type of boilers at Danish district heating plants.

The boiler may be fitted with an external heat exchanger (economizer) to utilise any remaining heat (including latent heat) in flue gasses.

Boilers for district heating have been used for decades. Today, many gas fired district heating boilers are used for peak-load or backup capacity. During periods with low electricity prices, gas fired district heating boilers have accounted for a relatively large part of the district heating production as it has been less feasible to operate the engines at CHP plants.

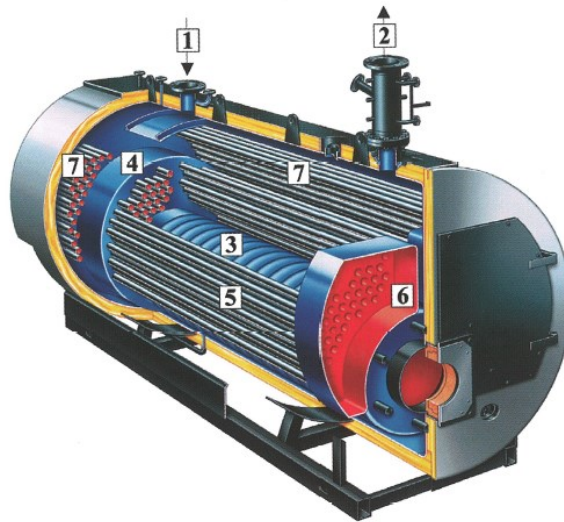

Figure 1 Typical flue gas tube boiler for the power range 1- 20 MW. Combustion takes place in the firetube (3). Flue gasses then passes inside a number of flue gas tubes ((5) & (7)) transmitting further heat to the boiler water around these. The water connections (forward/return) are on the top ((2) & (1)) [6].

Input

Natural gas or biogas.

Output

District heat.

Typical capacities

0.5-20 MJ/s.

Regulation ability and other power system services

Gas fired boilers has a wide turn-up/turn-down ratio. The load can typically be adjusted within 15-100% load. If in operation, this can be done within a few minutes if needed.

If not heated, start-up of cold boilers often takes some 30 minutes.

Advantages/disadvantages

Advantages

Gas fired boilers are a proven and well-known technology. They can be supplied over a wide range of output capacities. Load response is good.

The boilers may also be used for heat extraction at medium- or high-temperature from waste process air.

Heat pumps, either electrical or absorption, may be added to utilize flue gas heat, thereby increasing the efficiency of the heat pump.

Disadvantages

When gas boilers are being fuelled with diesel or biogas, possibly in combination with natural gas, additional sulphur cleaning may be needed.

Environment

Sulphur, NO_x and methane emissions when burning natural gas are low compared to biomass or waste fired boilers.

If condensing operation is used, the condensate must be treated to comply with local wastewater standards and regulations before being led to sewage systems. Such treatment often includes pH adjustment.

Research and development perspectives

Multi-fuel operation has been made possible (gas/oil) if supplied with burners for such operation. Biogas is also widely used in same type of boilers. Some boilers can be fitted with special burners for wood dust (e.g. from ground wood pellets) thus enabling conversion to biomass.

Examples of market standard technology

If operated with low return water temperatures (30-35 °C), a district heating boiler with economizer can achieve a fuel efficiency up to approx. 106-107% (lower heating value (LHV) reference).

Prediction of performance and costs

Boiler technology, including gas fired boilers, is a commercial technology with large deployment on both national and international scale. Gas boilers are a commercial technology with a moderate need for R&D, making it a category 4 technology.

Development of the burner technology or post treatment of flue gas may lead to lower emission levels.

Uncertainty

Uncertainty stated in the tables both covers differences between various products and differences related to the power span covered in the actual table.

A span for upper and lower product values is given for the year 2020 situation. No sources are available for the 2050 situation. Hence the values have been estimated by the authors.

No reliable sources are present for the uncertainty of the 2050 numbers listed. However as a deployed, mature and highly fuel-efficient technology, there is relative little uncertainty in performance numbers given.

Additional remarks

Power production units have been developed to be installed in connection with gas fired boilers. The flue gas from power production units can be used as preheated combustion air for the boiler burner.

Data sheets

Technology	44 District heating boiler, natural gas fired									
	2015	2020	2030	2050	Uncertainty (2020)		Uncertainty (2050)		Note	Ref
Energy/technical data					Lower	Upper	Lower	Upper		
Heat generation capacity for one unit (MJ/s)	0.5 -10									
Total efficiency, net (%), nominal load	105	105	106	106	95	107	96	108	A	1, 2, 3
Total efficiency, net (%), annual average	103	103	104	104	93	105	94	106	B	1, 3
Electricity consumption for pumps etc. (% of heat gen)	0.15	0.14	0.12	0.1	0.13	0.2	0.08	0.15	L	1
Forced outage (%)	1	1	1	1	0.08	2	0.08	2		3
Planned outage (weeks per year)	0.4	0.4	0.4	0.4	0.3	0.6	0.3	0.6	F	3
Technical lifetime (years)	25	25	25	25	25	>25	25	>25	K	3
Construction time (years)	0.5	0.5	0.5	0.5	0.2	0.7	0.2	0.7	F	9
Space requirement (1000m2 per MJ/s)	0.005	0.005	0.005	0.005	0.003	0.01	0.003	0,01	E	2
Plant Dynamic Capabilities										
Primary regulation (% per 30 seconds)	-	-	-	-	-	-	-	-	C	
Secondary regulation (% per minute)	-	-	-	-	-	-	-	-	C	
Minimum load (% of full load)	15	15	15	15	10	20	10	20		9
Warm start-up time (hours)	0.1	0.1	0.1	0.1	0.08	0.15	0,08	0.15	D	9
Cold start-up time (hours)	0.4	0.4	0.4	0.4	0.3	0.5	0.3	0.5	D	9
Environment										
SO ₂ (g per GJ fuel)	0.3	0.3	0.3	0.3	0	0.3	0	0.3	H	1
NO _x (g per GJ fuel)	10	9	7	6	8	60	5	30		1, 2
CH ₄ (g per GJ fuel)	3	3	2	2	2	6	2	6		1, 2
N ₂ O (g per GJ fuel)	1	1	1	1	NA	NA	NA	NA	I	7
Financial data										
Nominal investment (M€ per MJ/s)	0.06	0.06	0.05	0.05	0.035	0.25	0.035	0.25	J	2, 3
- of which equipment	0.04	0.04	0.03	0.03	0.025	0.15	0.025	0.15		2, 3
- of which installation	0.02	0.02	0.02	0.02	0.01	0.1	0,01	0.1		2, 3
Fixed O&M (€/MJ/s/year)	2,000	1,950	1,900	1,700	1,000	2,500	1,000	2,500	F	
Variable O&M (€/MWh)	1.1	1.1	1.0	1.0	0.6	2.1	0.6	2.2		
- of which is electricity costs (€/MWh)	0.1	0.1	0.1	0.1	0.1	0.1	0.1	0.2	L	
- of which is other O&M costs (€/MWh)	1.0	1.0	0.9	0.9	0.5	2.0	0.5	2.0		8, 9

Notes:

- A Includes a condensing economizer, without economizer the efficiency will be up to some 93-97 %, LHV reference
- B Includes a condensing economizer, without economizer the efficiency will be up to some 92-95 %, LHV reference
- C Not Relevant for heat-only technologies
- D Boilers with low water content (e.g. watertube instead of shell tube 3-5 pass boilers) are used start up time from cold is shorter
- E Boilers in the low power range approx. 0.010 and boilers in the higher power range 0.003
- F DGC Estimate
- G Ultra Low NOx burners can reach a level of 5 g/GJ
- H Fuel dependent, not technology dependent
- I No data available
- J The average numbers are for a 2-3 MW boiler installation
- K Technical lifetime often exceeds 25 years
- L The cost of auxiliary electricity consumption is calculated using the following electricity prices in €/MWh: 2015: 63, 2020: 69, 2030: 101, 2050: 117. These prices include production costs and transport tariffs, but not any taxes or subsidies for renewable energy.

References

- [1] DGC Statistics, Efficiency and Emission test reports from district heating plants, up to and including 2014
- [2] Burner and boiler manufacturer's information 2015
- [3] Danish District Heating Association, information given to the 2012 survey for the report
- [4] Inputs given by Trade Organisation and boiler installation Company
- [5] Industriell Energigasteknik, Gas Akademin, SGC 2011
- [6] Industriell Energigasteknik, Gas Akademin, SGC 2004/Viessmann
- [7] National Environmental Research Institute, Denmark 2009
- [8] Elsam/Elkraft update, Teknologidata for el- og varmeproduktionsanlæg, 1997
- [9] DGC calculations, estimates

45 Geothermal District Heating

This chapter is updated in October 2013 and is under review.

This chapter has been moved from the previous Technology Data Catalogue for Electricity and district heating production from May 2012. Therefore, the text and data sheets do not follow the same guidelines as the remainder of the catalogue.

Brief description

Geothermal energy is energy located in underground water reservoirs of the earth. On average the temperature of the reservoir increases with around 3 °C per 100 m depth. Recent definitions of geothermal energy include all heat from the ground. Here, only heat produced through deep wells is described including the option to use the wells for heat storage.

Heat from deep reservoirs can be utilized directly through a heat exchanger. However, both the temperature and the pumping costs increase with the depth. From Danish experiences it is thus economically more attractive to use heat pumps and extract heat from shallower reservoirs, typically at 800-3000 m depth, where temperatures are 30-90 °C. The heat pumps can either be compressor heat pumps driven with electricity or absorption heat pumps driven by heat. The geothermal water has a high salinity - often 10-20%. For comparison, sea water has a typical level of salinity around 3.5%.

Different concepts for extraction of the geothermal heat exist. In the doublet system, warm geothermal water is pumped to the surface from a production well and the heat depleted brine pumped back into the source reservoir via an injection well in order to maintain the pressure; the bottom-hole spacing is designed to delay premature cooling of the production well.

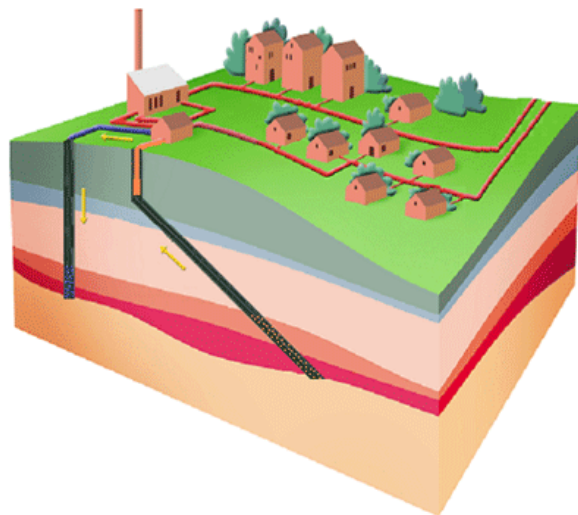

The principle of the doublet system
(ref: www.geotermi.dk).

Several boreholes may also be drilled from one site. This will decrease the cost of heat. Also, one or more of the boreholes may then be used for heat storage, e.g. seasonal, by injection of hot water during the summer and production during winter. However, injection of hot water into the boreholes may cause permeability reductions and change reservoir properties. A study is currently undertaken to assess benefits and problems associated with heat storage (ref. 4).

Absorption heat pumps driven by district heating biomass boilers can be used to elevate the temperature of the produced heat and increase the heat extraction. Extracting more heat can lower the temperature of the geothermal water to 10-20 °C before it is pumped back to the reservoir via the injection well. In some cases the cooling by heat pumps can help to reduce gas separation (from the water) and avoid precipitation, which may clog the reinjection well.

Currently two geothermal district heating plants are operating in Denmark – in Thisted (7 MJ/s geothermal heat) and Copenhagen (14 MJ/s geothermal heat). A third plant is expected to start production in 2013 in Sønderborg (12.5 MJ/s geothermal heat). (ref.2)

Geothermal district heating (GDH) in Europe is nearing a total capacity of 5,000 MJ/s. The two largest schemes address the heating of the city of Reykjavik and of the Paris suburban area.

GDH provides almost all of Reykjavik's district heating demand with an installed capacity of 830 MJ/s serving 180,000 people, 60 million m³/year of water at an average 75°C (user inlet) temperature. An important part of the hot water supply is piped from distant wells and there is no reinjection of the heat depleted water (ca 35°C) underground.

The Paris Basin GDH system is based on a sedimentary resource and on a doublet system for heat extraction. Here, hot water at an average temperature of 70°C is pumped from depths of 1500 to 1800 m. The system consist of thirty-four geothermal doublets (and as many heating grids), it has been operating since the early 1980's in the Paris area, the total installed power and generating capacities is 230 MJ/s and 1,000 GWh/year respectively (ref. 3).

About 10 GW electricity generation capacity is installed in the World, primarily as base load (ref. 2).

Input

Heat from brine (saline water) from underground reservoirs.

Output

Heat for district heating.

Electricity, if geothermal temperatures are high.

Typical capacities

7-20 MW per doublet without heat storage

Regulation ability

The general experience is that the geothermal energy should be used as base load, e.g. covering 1/3 of the total district heat supply. The main reason is economy.

Research and development

Heat extraction from hot dry rock layers at e.g. 3000-4000 meters below surface is yet to be investigated in Denmark. The challenge is to increase the extremely small natural fractures, allowing water to be heated to temperature levels, where it can be used for power production.

Seasonal heat storage in geothermal reservoirs is being investigated in Denmark, including investigations of the selection of suitable geological formations, identification of risks associated to heat storage and determination of a suitable injection strategy. (ref. 4)

Better utilization of the geothermal resources could be achieved through lowering the district heating temperatures.

Advantages/disadvantages

Advantages:

- Established technology for heat production for district heating
- Cheap running costs and “fuel” for free
- Renewable energy source and environmental friendly technology with low CO₂ emission
- High operation stability and long lifetime
- Potential for combination with heat storage.

Disadvantages:

- No security for success before the first well is drilled and the reservoir has been tested
- High initial costs
- The best reservoirs not always located near cities
- Need access to base-load heat demand

Environment

Utilization of geothermal energy is very CO₂ friendly. Pumps pumping the geothermal water typically use power equal to 5-10% of the heat from the geothermal water and CO₂ emission depends primarily on how the heat pump is powered.

Examples of best available technology

Application of seasonal heat storage has been successfully demonstrated in Neubrandenburg, Germany (ref. 1).

A geothermal plant in Thisted, Denmark, has produced heat since 1984 producing heat for district heating. 7 MJ/s heat is extracted from 44 °C thermal water by absorption heat pumps driven by a straw based district heating boiler.

Additional remarks

An example of a system with an absorption heat pump is illustrated below. The numbers indicate the energy flows relative to the extracted amount of geothermal heat from the reservoir, which is set 100 energy units. The energy used for the submerged pump will to some extent be recovered as heat in the geothermal water. However, as a rough estimate, the heat losses in the well will correspond to the energy used for pumping, and thus 100 energy units are assumed available for district heating.

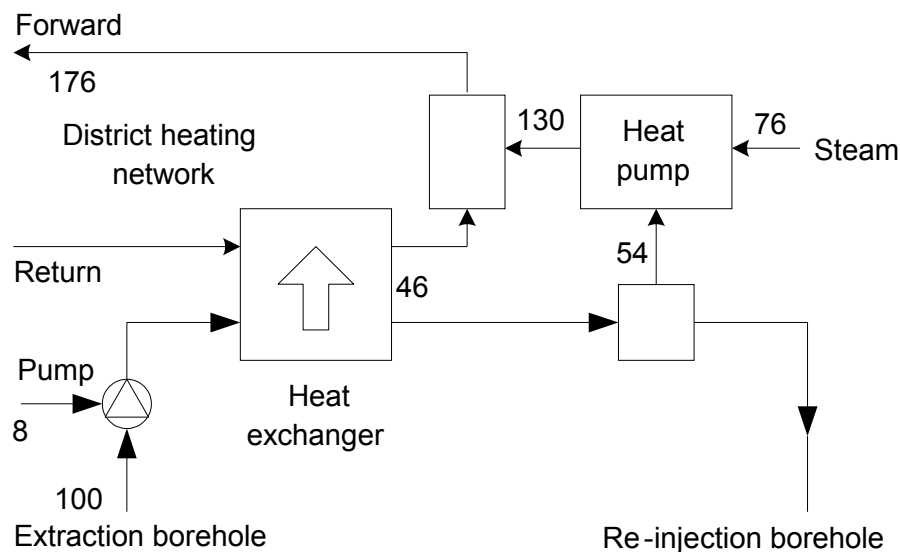

Part of the geothermal heat (46) is used for direct heating of the return water from the district heating network, while the remainder (54) is used as heat source for the heat pump (the figure is very simplified, as some return water and all of the water from the heat exchanger is heated inside the heat pump plant). The COP (heat out / drive energy) of the heat pump is approx. 1.7. Thus, the total heat output of the system equals the geothermal input plus the drive energy: $100 + 76 = 176$ and the COP of the total system is approx. 2.1.

The steam to drive the absorption heat pump (76 energy units) may be delivered by a district heating plant (e.g. biomass or waste incineration). If the drive steam is delivered by a combined-heat-and-power plant, the extracted steam will cause a decrease in electricity generation.

Electricity consumption for the geothermal circulation pumps is normally 5-10% of the heat extracted from the geothermal water, but the exact number will depend on amongst others the depth of the reservoir, and the cooling of the geothermal water.

Investment cost structure of typical geothermal plants in Denmark (ref. 2):

Exploration	2%
Wells, well tests	46%
Geothermal surface loop	15%
Heat pump plant	29%
Interest during construction	7%
Total	100%

The heat generation costs depend primarily on geological data (depth, thickness, permeability and temperature) and the heat system (heat demand, duration curve and forward/return temperatures). A heat demand exceeding 300 – 500 TJ annually with access to supply base load is normally required.

Electric heat pumps can in some cases extract more geothermal energy than absorption heat pumps. They may cool the geothermal water below the approx. 10-20°C obtainable using absorption heat pumps and their drive energy may constitute a smaller part of the heat output. On the other hand electricity is in general substantially more expensive than heat, making electric heat pumps more expensive to operate.

An example of a system with an electric heat pump is illustrated below. The COP of the electric heat pump is approx 4.5 and the COP of the total system is approx. = 4.6.

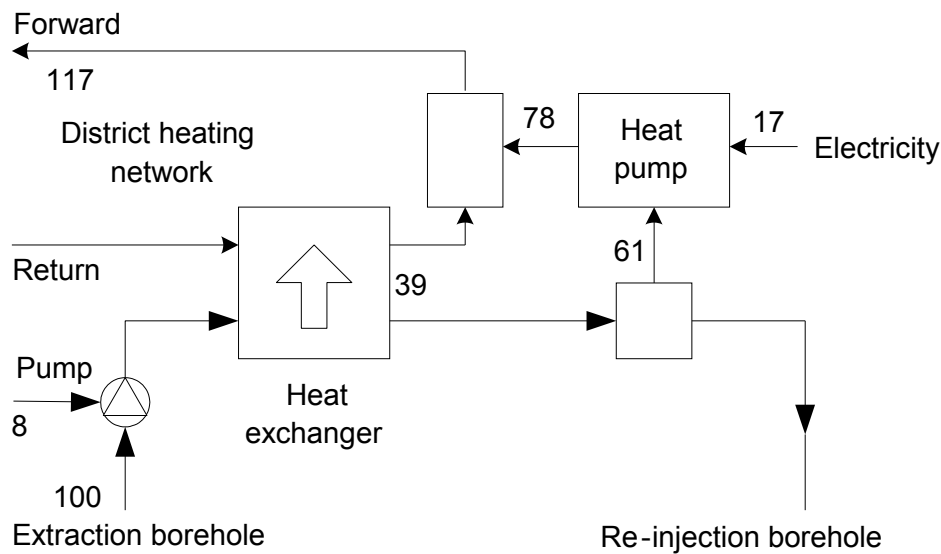

References

- 1) “Geotermi – Varme fra jordens indre” (Geothermal energy – Heat from inside the Earth; in Danish); Danish Energy Agency, October 2009.
- 2) Dansk Fjernvarmes Geotermiselskab, 2011, including www.geotermi.dk
- 3) The European Geothermal Energy Council, www.egec.org
- 4) “HeHo - Heat Storage in Hot Aquifers”, Four-year research project supported by the Danish Council for Strategic Research (2011-2015). <http://www.staff.dtu.dk/ilfa/HeHo>

Data sheets

Two examples for systems using an absorption heat pump are given. In both cases, steam from a district heating plant is used to drive the absorption heat pump. The heat content of the steam would otherwise have been supplied directly to the district heating network at the same cost, and it has therefore been ignored in the economic data. Furthermore one example for a system with an electric heat pump is presented. The energy flows are presented relative to the extracted amount of geothermal heat from the reservoir, as for the figures above.

Technology	Geothermal heat-only plant with steam-driven absorption heat pump - 70 C, Denmark					
	2015	2020	2030	2050	Note	Ref
Energy/technical data						
Temperature of geothermal heat (degrees C)	approx. 70					1
Heat from geothermal source (%)	100	100	100		B	1
Electricity demand, heat pump (%)	76	76	76		B	1
Heat generation capacity (%)	176	176	176		B	1
District heat forward temperature, winter (C)	80	80	80			1
Electricity consumption for pumps etc. (%)	8	8	8		A,B	1
Technical lifetime (years)	25	25	25			1
Construction time (years)	4-5	4-5	4-5			1
Financial data						
Specific investment (M€ per MJ/s geothermal heat)	1.8	1.8	1.8			1
O&M excl. electricity consumption (€/year per MJ/s geothermal heat)	47,000	47,000	47,000			1

References

[1] Dansk Fjernvarmes Geotermiselskab, 2011

Notes:

- A This is the total electricity demand for submerged pumps and reinjection pumps. Earlier versions of this document showed consumption of the same level for each of the pumps. This was an error.
- B Percentage of geothermal heat

Technology	Geothermal heat-only plant with steam-driven absorption heat pump - 50 C, Denmark					
	2015	2020	2030	2050	Note	Ref
Energy/technical data						
Temperature of geothermal heat (degrees C)	approx. 50					1
Heat from geothermal source (%)	100	100	100		B	1
Electricity demand, heat pump (%)	108	108	108		B	1
Heat generation capacity (%)	208	208	208		B	1
District heat forward temperature, winter (C)	80	80	80			1
Electricity consumption for pumps etc. (%)	5	5	5		B	1
Technical lifetime (years)	25	25	25			1
Construction time (years)	4-5	4-5	4-5			1
Financial data						
Specific investment (M€ per MJ/s geothermal heat)	2.0	2.0	2.0			1
O&M excl. electricity consumption (€/year per MJ/s geothermal heat)	49,000	49,000	49,000			1

References:

[1] Dansk Fjernvarmes Geotermiselskab, 2011

Notes:

- [1] Usually geothermal reservoirs at a lower temperature will be shallower than reservoirs with higher temperatures. This will lead to higher permeability lower pressure drops in the reservoir and therefore lower electricity consumption for pumps.
- [2] Percentage of geothermal heat

Technology	Geothermal heat-only plant with electric heat pump- 70 C, Denmark					
	2015	2020	2030	2050	Note	Ref
Energy/technical data						
Temperature of geothermal heat (degrees C)	approx. 70					1
Heat from geothermal source (%)	100	100	100		B	1
Electricity demand, heat pump (%)	17	17	17		B	1
Heat generation capacity (%)	117	117	117		B	1
District heat forward temperature, winter (C)	85	85	85			1
Electricity consumption for pumps etc. (%)	8	8	8		A,B	1
Technical lifetime (years)	25	25	25			1
Construction time (years)	4-5	4-5	4-5			1
Financial data						
Specific investment (M€ per MJ/s geothermal heat)	1.6	1.6	1.6			2
O&M excl. electricity consumption (€/year per MJ/s geothermal heat)	37,000	34,000	34,000			2

References:

- [1] Dansk Fjernvarmes Geotermiselskab, 2011
- [2] Estimated by Danish Energy Agency and Energinet.dk, 2011.

Notes:

- A Earlier versions of this document showed an electricity consumption of approx. 9 %. However, the exact consumption will always depend on the local situation. For similar conditions (temperature, depth and permeability) the electricity consumption for pumps will be comparable, irrespective of whether a steam driven or electricity driven heat pump is used for heat extraction. The estimated consumption has thus been adjusted to match the consumption of the steam driven system described further above.
- B Percentage of geothermal heat

46 Solar District Heating

Contact information:

Danish Energy Agency: Filip Gamborg, fgb@ens.dk

Energinet.dk: Rune Grandal, rdg@energinet.dk

Author: Max Guddat, PlanEnergi

Publication date

October 2018

Amendments after publication date

Date	Ref.	Description
October 18	46 Solar District heating	Qualitative description and datasheet updated

Brief technology description

Collecting energy from the sun using it to heat water is a technology, which has been in use for many years. Today, more than 580 million m² of solar collectors are installed around the globe, with a total installed capacity of 410 GW_{th}. Although the majority of this capacity is used for small domestic hot water systems, the fastest growth rate is for large systems (mainly for district heating) [1].

Three different types of solar panels are produced:

- Flat Plate Collectors (FPC) (Basic principle visualised in Figure 2)
- Evacuated Tubular Collectors (ETC)
- Concentrated Solar Power (CSP)

Flat plate large module collectors are by far the most common collector type used for district heat in Denmark. ETC-collectors are more efficient than flat panels at higher temperatures, but also more expensive. CSP can produce heat at high temperatures. It is possible to combine different collector types in one system; e.g. using flat plate collectors in the “cold section” of the field in order to preheat the heat transfer-fluid before evacuated tubes or CSP collectors in the “hot section”. Currently one solar heating plant has both flat plate panels and CSP (Taars). Due to the applicability in the context of Danish district heating, focus in this catalogue is on FPC.

As shown in Figure 2, the principle of flat solar panels in a district heating system is to absorb the solar energy in order to heat a fluid. Corrugated copper or aluminium-sheets serve typically as absorber, with the transfer-fluid being circulated behind these. The absorbers are surrounded by a glass layer, protecting the absorber from the surrounding environment. The back of the panel is insulated, in order to reduce heat loss, cf. Figure 3. The heat is transferred from the circulated fluid to district heating water via a heat exchanger.

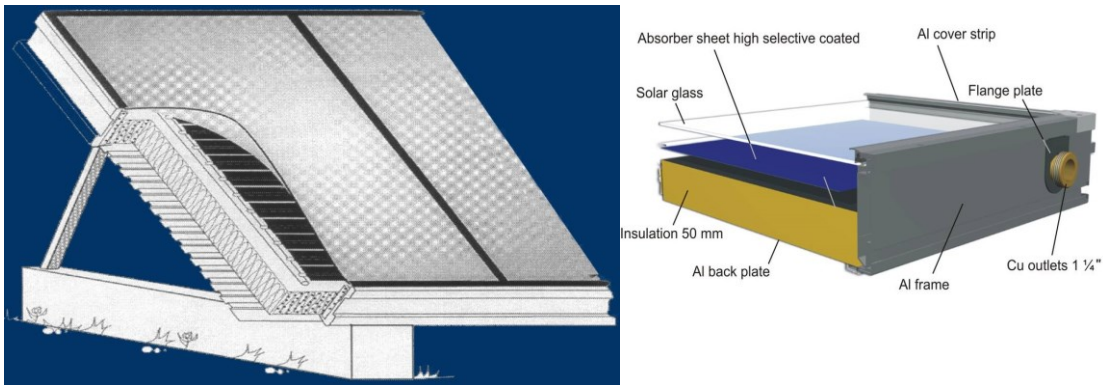

Figure 2 Basic principle of a flat plate solar collector.

For district heating systems, the collectors are typically installed on the ground in long rows connected in series. In Danish systems, the solar heating system normally takes in the return water and heats it up to the desired forward flow temperature. All plants have the solar collectors mounted on the ground. Ground mount foundations can be concrete blocks, concrete foundations or steel foundations.

In principle, solar district heating is operating all hours of the year, but of course, the heat production depends on the solar irradiation, weather conditions, time of day and the season of the year. The seasonal variation can be compensated using a seasonal storage. Typical performance of large solar collector fields in Denmark is ca. 450 kWh/m²/year. This corresponds to an efficiency of around 40 % (40 % of the solar irradiation is utilized).

Efficiency and energy yield

The yield of a solar collector depends on the solar collector type and size, the solar radiation, the temperature of the collectors and the ambient temperature. The efficiency is defined by efficiency parameters, and values for these are available in the Solar Keymark Database [7], [8]. Figure 3 visualises the source of radiation, optical losses and thermal losses of a solar thermal system (FPC).

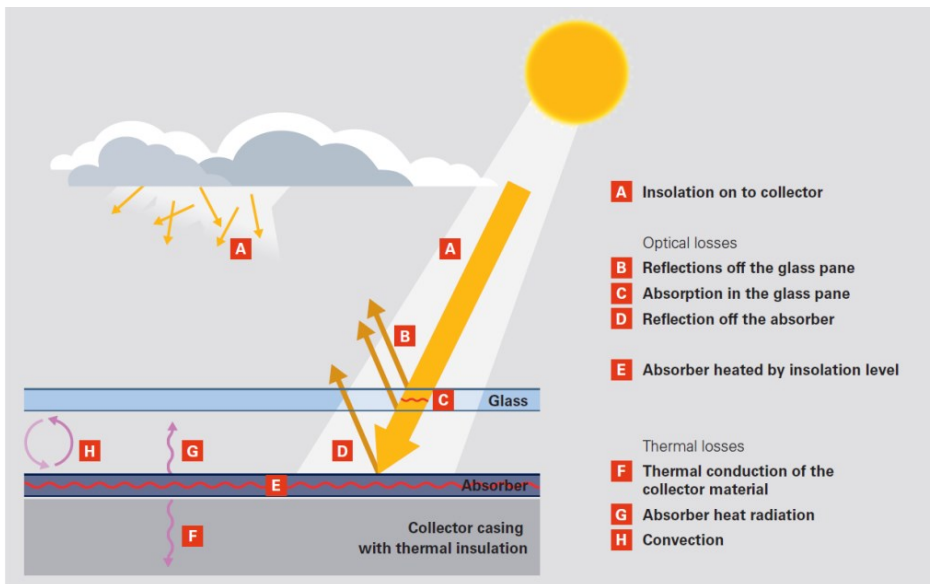

Figure 3 Example of utilisation rate of solar energy and effects influencing the efficiency. [10]

The efficiency of a FPC depends on the temperature difference between the ambient air and the average temperature of the fluids. The lower the temperature difference, the higher the efficiency. Therefore, the thermal performance at a given radiation level is higher at lower temperature differences. The efficiency depends on the flow, since this is how the temperature difference is controlled. The dependency between efficiency and temperature difference is illustrated in Figure 4.

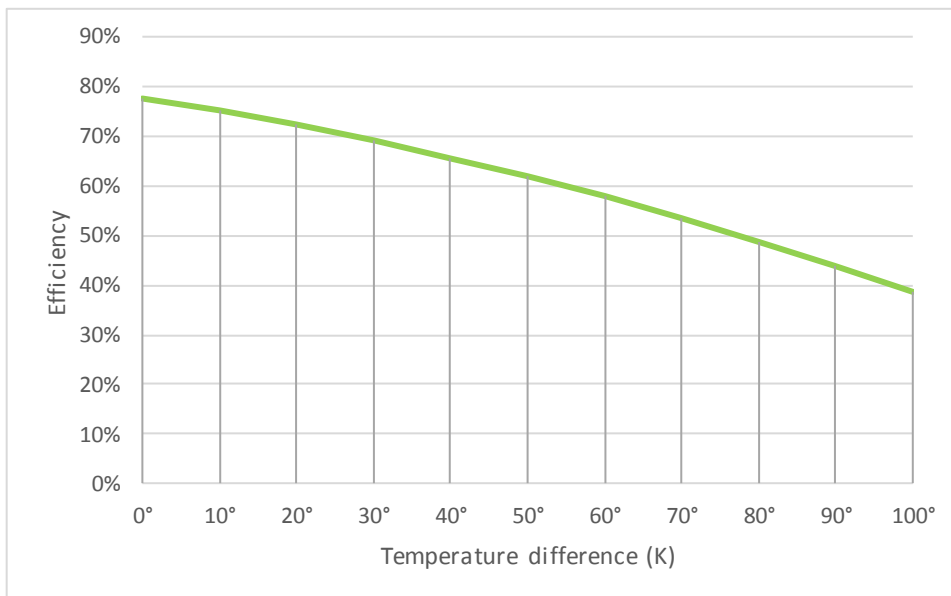

Figure 4 Efficiency as a function of temperature difference.
 (Based on data from [8], example with $G=1.000 \text{ W/m}^2$, $\eta_0=0.777$, $a_1=2.41$, $a_2=0.015$)¹⁸

FPCs are typically produced in two product classes that differ by the energy efficiency of the collectors. Higher efficiencies may be achieved by applying an additional insulating layer, e.g. polymer foil or an extra layer of glass. The SUNSTORE 3-project [15] evaluated the business economic optimal ratio of FPC with/without an extra insulating layer for the solar district heating system for Dronninglund District Heating. In the project it was concluded that under the given circumstances regarding temperature levels, the economic optimum was to only install collectors with an extra insulating layer. In other projects, it is chosen to combine the two levels of insulation, in order to let the less insulated panels preheat the absorber fluid, before boosting it in the better insulated ones. Whether only high efficient or a combination of efficient and high efficient panels are installed, is evaluated from case to case.

The specific yearly thermal output of flat plate solar collectors is around 300-600 kWh/m², with an average of around 450 kWh/m² in the years 2012-2015. This shows variation due to solar radiation and site-specific conditions, as well as other aspects [4].

A performance guarantee may be given by the contractor. Fact Sheet 3.3 in [13] describes a method for performance guarantees. A performance guarantee may be given for certain operation situations at given solar radiation and temperatures (mean absorber fluid and outdoor temperatures). However, the guarantees provided by the producers do not ensure yearly specific annual thermal outputs. Yet given the performance guarantees, likely yearly outputs may be assessed quite accurately, when also taking into consideration the uncertainties regarding solar radiation and temperature variations.

¹⁸ G = Total (global) irradiance on the collector surface
 η_0 = Maximum efficiency if there is no heat loss (also referred to as the “optical efficiency”).
 a_1 and a_2 = first and second order heat loss coefficients cf. European Standard EN12975 for efficiency of solar collectors.

Application of solar thermal systems in district heating systems

A solar thermal plant consists of:

- Solar collectors
- Transmission pipeline
- Tank storage
- Tank and collection tank for heat-transfer fluid (e.g. glycol/water)¹⁹
- Heat exchanger, including pumps, valves etc.
- Integration of control with the existing plant

A schematic drawing of a solar thermal system integrated with a district heating grid can be seen in Figure 5.

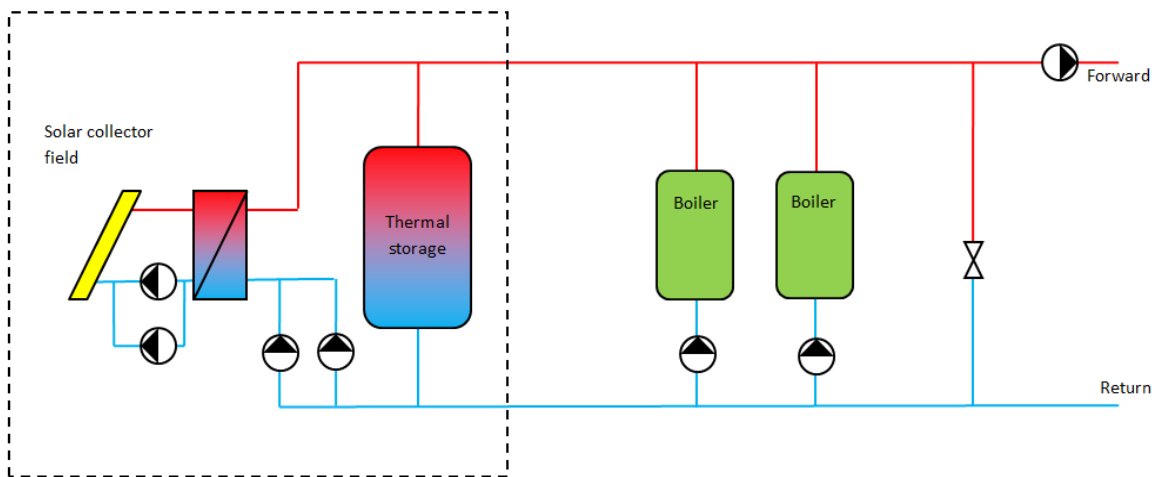

Figure 5 Schematic drawing of a possible system integration of solar district heating [5].

When properly designed, solar collectors can work when the outside temperature is well below freezing, and they are protected from overheating on hot, sunny days.

All district heating systems equipped with solar heating utilize them as a supplement to other heat generating units, thereby ensuring that all consumers' heat demands are met, also when there is insufficient solar irradiation available.

The tilt of the collector panels can impact both annual total yield and production curve production over the year. Hence the tilt of the collector panels becomes an optimization parameter as production can be increased in the autumn at the expense of max. thermal effect and hence production during the summer (where the solar irradiation typically peaks).

¹⁹ Circulated in the solar thermal collectors. The heat-transfer fluid is typically separated from the district heating water by a heat exchanger, cf. the illustration.

Production of solar heating is taking place when the heat demand is lowest – both on daily and seasonal basis. The share of solar heating in a district heating system without heat storage is relatively low (5-8 % of yearly heat demand). Hence, the most common application is the combination of a solar thermal system with a diurnal heat storage, which will enable approximately 20-25 % share of solar district heating in a district heating system. A typical Danish system with a short-term heat storage of 0.1 - 0.3 m³ per m² solar collector covers correspondingly 10 – 25 % of the annual heat demand [4].

Moreover, the combination with a seasonal heat storage can increase the share of solar heating to 30-50 % and in theory up to 100 %. Hence, there is an important synergy with seasonal storage technologies, cf. chapter 60 “Seasonal Heat Storage”.

Input

The input is solar radiation.

Outside the atmosphere of the Earth, the solar radiation is 1367 W/m² [6]. The solar radiation is highest perpendicular to the solar beams; this is why solar collectors in Denmark are placed with an angle of approximately 30-40 degrees, while also taking into consideration the cast of shadows [13].

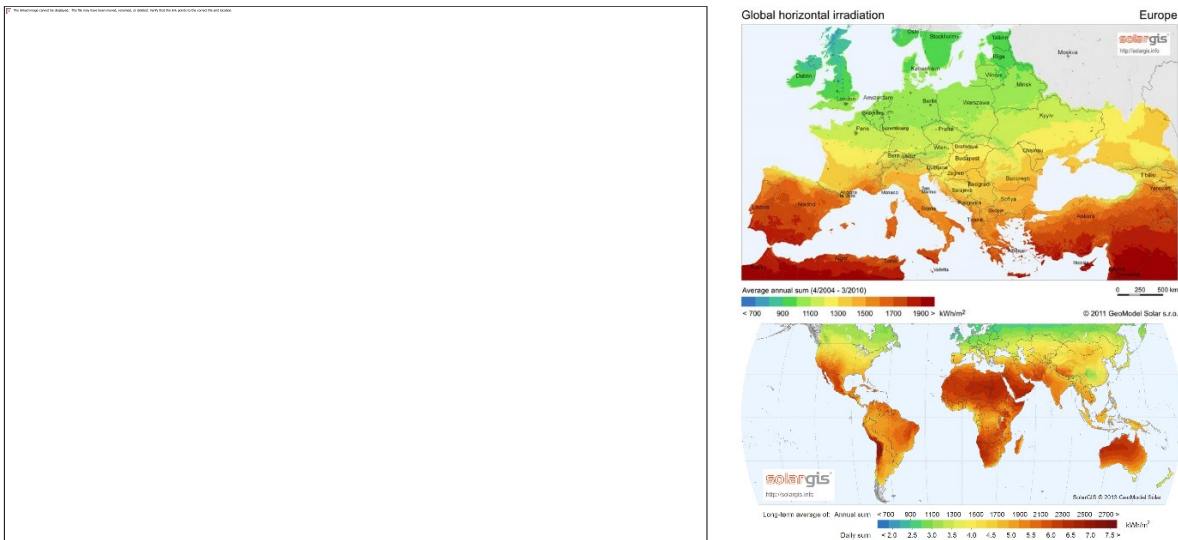

Figure 6 The amount of radiation in Denmark, Europe and the World is illustrated in the maps [6].

As mentioned earlier, the production from solar collectors are highly depended on the seasonal variations of radiation. Figure 7 shows the seasonal variation of the heat generation from a typical solar collector in Denmark as generation in the specific month as the percentage of the average monthly generation.

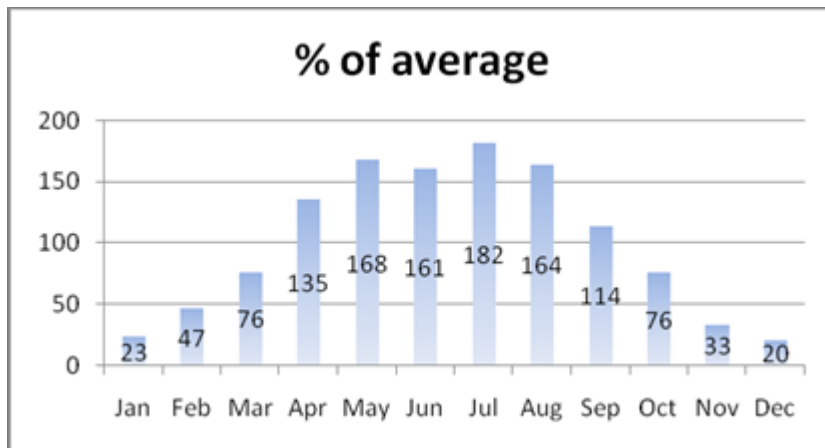

Figure 7 The seasonal variation of heat generation from typical solar collectors in Denmark [3].

Output

Hot water for district heating.

The thermal performance of solar heating plants is first of all influenced by the temperature level of the solar collector fluid. Besides that, the thermal performance is also influenced by the weather, the collector type, the solar collector fluid, the flow volume and the collector tilt.

Typical capacities

The typical application of solar thermal plants for district heating purposes aims at a solar share of 10-25 % of the annual heat demand [4]. Thus, the installed capacity varies by the plant.

Figure 8 shows the development in number of plants and collector area, illustrating that the plants being implemented now is larger than previous plants. Cf. Figure 8 the average plant size has increased rapidly in recent years, indicating two key trends: Larger systems in general and higher solar shares in the plants that decide to invest in solar thermal district heating.

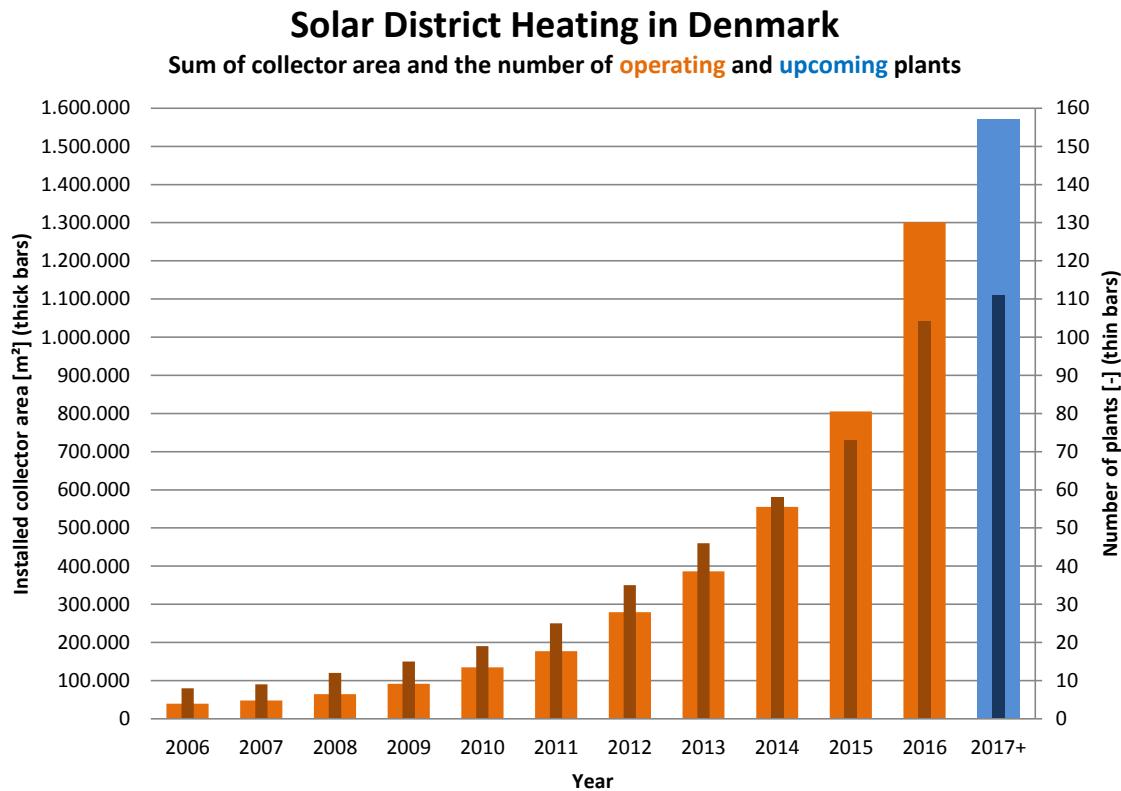

Figure 8 Solar district heating plants in Denmark in operation (until 2017) and planned. The trend is that the new plants are larger and include seasonal heat storages [5].

In the context of the size and heat demand in Danish district heating plants, typical sizes for solar thermal installations are in the range of 5-15,000 m². With increasing plant sizes and/or increased solar coverage share, this figure increases. The biggest plant in operation in Danish district heating grids (as of June 2017) is the solar thermal at Silkeborg District heating at 156,694 m², followed by Vojens with approx. 70,000 m² (completed in two steps).

Examples of best available technology

There are several suppliers of FPC for solar district heating, [14], with the panels from Danish Arcon-Sunmark being the most widely applied option in Denmark. From an international perspective, manufacturers like Austrian GREENoneTEC, TiSUN and Finish SavoSolar offer large FPC-panels too. As of early 2017, there are in total more than 100 plants and 1.3 million m² collectors installed in district heating plants around Denmark (while only considering plants sizes >1,000 m²). This is a significant increase from less than 100,000 m² in 2009. The placement, plant data and production data can be found for several plants in [2] and is visualised in Figure 8.



Figure 9 Solar heating plants in Denmark – more than 100 plants with a total installed collector size of more than 1.3 million m². The map is interactive and includes detailed information on solar heating plants [2].

Examples of plants are:

- Brødstrup, Denmark: A combined energy system including 18,600 m² of solar collectors, 7,500 m³ heat storage tanks, 19,000 m³ pilot borehole seasonal heat storage (corresponding to approximately 9,000 m³ of water), an electrical driven heat pump, an electrical boiler, a natural gas fired engine (combined heat and power production) and natural gas fired heat-only boilers. Also an advanced control system, balancing maximum solar heat and maximum electricity sales. Solar coverage: 22 %. Established in 2007, expanded in 2012 [9].
- Dronninglund, Denmark: Solar panel field of 35,000 m², combined with a seasonal pit heat storage, filled with 60,000 m³ of water. The pit storage is used to store the heat produced in the summer, to be utilised during the winter. The solar plant yields 16,000 MWh per year and provides 40 % of the heat for the local district heating network with its 1,350 customers. Other heat sources are a natural gas fired engine and a boiler with an absorption heat pump, cooling the storage. The solar district heating (SDH) plant was commissioned in 2014 [9].
- Vojens, Denmark: The experiences made with the 17,000 m² large collector field since 2012 convinced Vojens Fjernvarme to plan adding another 52,500 m² (36.75 MW_{th}) to the field as well as seasonal storage, which should increase the annual solar share from the 14 % measured in 2014 to an expected 45 %. The expansion was commissioned in May 2015 [9].
- Silkeborg, Denmark: Solar panel field of 156,694 m². Commissioned late 2016, making it the world's largest SDH-plant at the time. Other heat sources in the system are natural gas fired CHP, an electric boiler and industrial excess heat.

An overview of the World's largest installations can be found in [9] and [14].

Research and development objectives

More suppliers have entered the market in Denmark, offering different technologies. This implies that there is a process of improvement of the efficiency of the panels as well as reduction of the costs of the panels.

Examples of research and development objectives include:

- Production of panels – e.g. extruded absorber aluminium panels (Savo-Solar)
- Absorbers – increased absorbance and reduced emittance
- Improved absorber design – increased heat transfer to fluid and better flow distribution
- Use of concentrating collectors (CSP)
- Improved plant layout – serial connection of different collector types in rows and optimised serial/parallel connections for solar collector fields
- Control strategies – optimised integration of solar in existing district heating plants

Additionally, [4] contains an extensive list of possible development aspects of solar heating.

Regulation ability and other system services

Regulation with regard to electricity is not relevant for solar thermal plants.

There are however other relevant regulation aspects for solar thermal collectors, e.g. the possibility to vary the flow of the absorber fluid. By varying the flow of the absorber fluid, the temperature in the plant can be regulated. This is especially important, considering the variation in intensity of solar radiation. Varying the flow secures the possibility to optimize the flow rate according to the external circumstances and desired output temperature.

Boiling of the absorber fluid can cause reduction of the corrosion protection. Ways to avoid boiling are the installation of conventional cooling towers or the scheduled and preventive cooling of stored heat by circulating water through the plant at night. The latter is applied in many Danish plants, as it reduces the installation costs, but the cooling capacity of collectors is practically limited to FPC-technology and has decreased in recent years, due to the increased energy efficiency of collectors.

In the event that the thermal solar district heating plant is oversized compared to the available cooling capacity, the absorber fluids remains at risk of boiling.

Advantages/disadvantages

Advantages:

- Simple, robust and proven technology. More than 100 Danish district heating plants have solar thermal plants
- Long technical lifetime, proven at least 25-30 years
- Low maintenance costs, based on current plants approximately <math><1 \text{ €/MWh}_{\text{th}}</math> [11]
- Low electricity consumption required (3-4 kWh pr. produced MWh solar heating, primarily electricity consumption for circulation pumps) [11]
- No continuous presence of operation personnel required during operation
- Heat production price not sensitive to variable costs of fuel, easier budgeting of the heat price, when a share of the heat price is known
- CO₂-free energy source
- High energy yield pr. occupied land-area compared to e.g. biomass, in terms of possible energy production on a given area
- Easy reestablishment of area, no or low impact on the soil from the foundations
- Approx. 98 % of a plant can be recycled after decommission [12]
- Can be combined with heat pumps to increase yields

Disadvantages:

- Production dependent on solar radiation and weather conditions
- Summer load defines the size of the capacity in case of diurnal storage only
- Produces approx. 80 % of the heat energy during the period April – September, when the heat demand is lowest. Can be mitigated by including a seasonal heat storage [3]
- High area occupation, compared to other district heating technologies like boilers or heat pumps, approximately 3 m² ground area for each m² solar panel collector, near by the district heating network – although this can be mitigated with a transmission pipeline e.g. some km, which may imply additional costs
- High initial investment pr. MW, but with a depreciation period of 15-20 years, the heat production cost is competitive with e.g. biomass based heat production.

Environment

No emissions related to the heat production.

Anti-freezing agents such as organic glycols are typically added to the water in the system, in order to avoid frost damages in the winter. Leakage risks can be mitigated by installing monitoring systems, monitoring e.g. pressure in the system as well as moisture in the insulation material of the pipes.

The basic components of solar thermal collectors consist of metals, insulation material, glass and the above-mentioned anti-freezing agents. Thus, most of the used materials can be recycled after decommission.

Assumptions and perspectives for further development

Solar district heating has developed significantly during the recent years towards category 4 “Commercial, limited development potential”. This is illustrated by the significant deployment of solar district heating cf. Figure 8 in Section 46.1.5. Figure 10 visualizes the technological development phases for solar thermal.

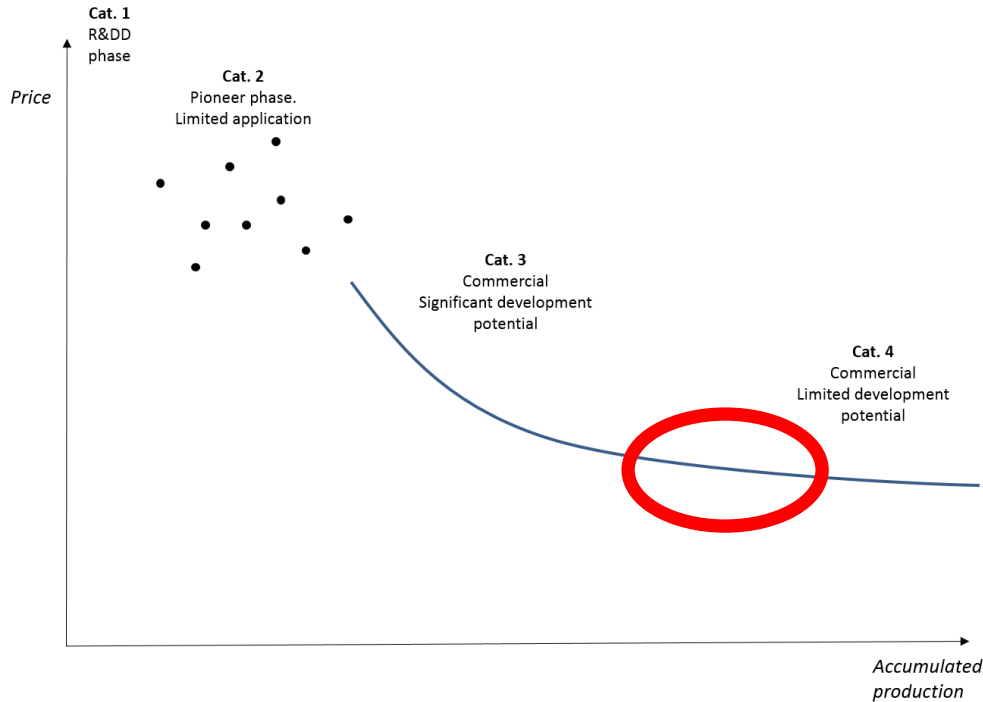

Figure 10 Technological development phases. Correlation between accumulated production volume (MW) and price.

There has been an increase of efficiency of production of solar thermal panels through automation. During the past decade, the production of solar panels has matured, resulting in lower production costs, which results in better business cases for the district heating utilities, due to a reduction in investment costs.

The cost of installation has been reduced by applying steel profiles instead of concrete foundations. This enables faster installation and is independent on the weather conditions at the time of installation – both these parameters contribute towards a reduction of the installation costs.

Design of the solar fields is another parameter, which can imply further reduction of the investment costs.

The yield of the solar panels has improved substantially during the past decade. This is due to various improvements in the materials and the elimination of thermal bridges that have improved the efficiency.

A potential for further development of solar district heating is control of the operation of the solar plants, i.e. flexibility. This relates to the role of solar district heating as one element in a complex system of different production and storage technologies – even at the same plant – thus efficiently utilizing the solar energy, while efficiently fulfilling the heat demand. The flexibility also includes meeting demands at lower supply temperature – which would improve the efficiency of the solar panels (cf. Figure 4).

The development potentials for solar thermal plants and how they are expected to influence the market situation for solar district heating are characterized by:

- Increased applications of solar district heating systems internationally
- Solar thermal with large storages (Economy of scale and increased independency of fluctuations in energy prices due to increased substitution of conventional heat production)
 - Leading to up to 80 % solar fraction of yearly heat demand
- More suppliers (an increased number of competitors is expected to result in increased development and competition):
 - Cf. the overview of suppliers in [4]
- Combination of solar thermal and biomass for 100% RES-district heating systems
 - Solar thermal already is business economically feasible in combination with wood chips and straw (including "energy saving" subsidy)
 - If designed correctly, SDH-plants can improve the operation of other heat producing capacity in the summer time, by covering the entire heat demand and thus eliminating inefficient part-load-operation etc.
- Other hybrid systems
 - Combinations with other technologies such as long term storages and heat pumps
- Solar thermal for large cities (Economy of scale and increased attention to these kinds of projects):
 - Graz; 265,000 inhabitants, 450,000 m² solar panels, 2.0 million m³ storage
 - Silkeborg, 156,694 m² solar panels
 - Belgrade – under investigation
- Solar with higher temperatures (new product developments):
 - Supply of industrial heat demands (i.e. for process energy demands)
 - E.g. CSP (concentrated solar power) and ORC (organic rankine cycle)

The correlation between the collector area and investments costs of solar heating plants in Denmark can be seen in Figure 10.

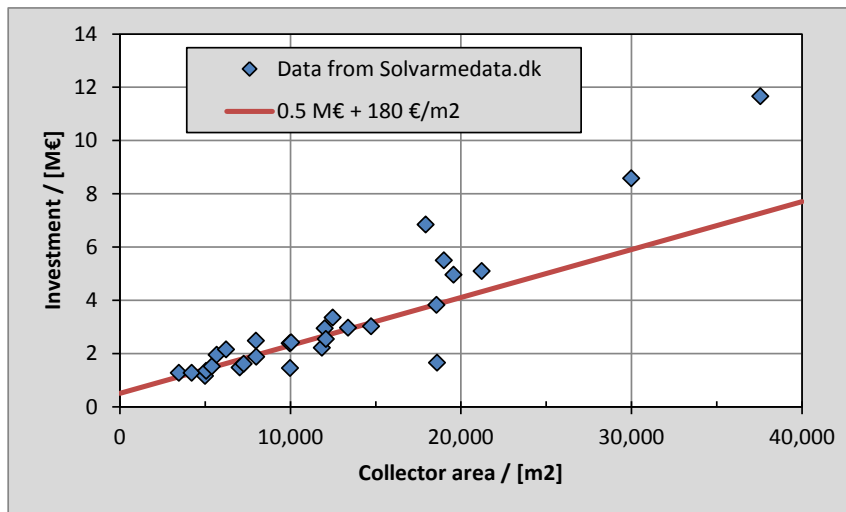

Figure 11 Solar plant investment for Danish SDH projects. The plant in the upper right corner is "Dronninglund" with 37,573 m² which includes a seasonal heat storage – and the investment for that is 2.4 M€ (see the section below on the seasonal heat storage), bringing this plant closer to the red line [5].

Different suppliers provide different quality at different prices. There seem to be a balance between quality and price, resulting in heat production prices on the same level due to different yields. Hence, there is increasing competition between suppliers, resulting in improved quality and lower prices.

As shown in Figure 11, there is a close correlation between investment costs and solar collector area for plants with a collector area below 15,000 m². When considering the investment costs of thermal solar plants with a collector area above 15,000 m² the investment costs is increasing faster than what is predicted by the regression line (the red line). This is predominantly because the larger plants include a seasonal heat storage (for example when considering the plant in the upper right corner, Dronninglund with a collector area of 37,573 m² and a seasonal heat storage). The investment for the seasonal heat storage alone is approx. 2.4 M€ (cf. Section 1.1.11, on *additional remarks* regarding the seasonal heat storage).

In conclusion, the above considerations illustrate that solar thermal is a well-proven and robust technology with a long technical lifetime. Solar thermal district heating is also competitive in large-scale applications in combination with other technologies, including seasonal heat storage technologies. The development potential for energy yields and cost reductions are estimated to be limited.

Uncertainty

Solar thermal plants are a low risk technology, which has matured in terms of reduction of production costs and improvement of the yield of the solar panels during the past few years. Consequently, the uncertainty on the provided parameters is considered small.

Additional remarks

Relevant sources of information includes:

- Factsheets from the IEA SHC Task 45 Project, www.Task45.iea-shc.org
- Guidelines developed in the Solar District Heating Project, <http://solar-district-heating.eu/Documents/SDHGuidelines.aspx>, i.a. detailed technical descriptions and considerations regarding operation economy and organization of an SDH-plant
- www.solvarmedata.dk and www.solarheatdata.eu, include data on specific plants
- Homepages of suppliers. Please refer to <http://solar-district-heating.eu/ServicesTools/FindProfessionals.aspx> for a list of suppliers.

Some district solar heating systems also have seasonal heat stores (cf. chapter '60 Seasonal heat storage'). Under Danish climatic conditions, a district heating system, which is based entirely on solar energy, needs a seasonal store with a volume of about 4 m^3 per m^2 of solar collector, provided a heat pump is installed to extract the heat energy from the storage. This ratio is based on a 50°C temperature difference $T_{\text{out}} - T_{\text{in}}$ of the storage water.

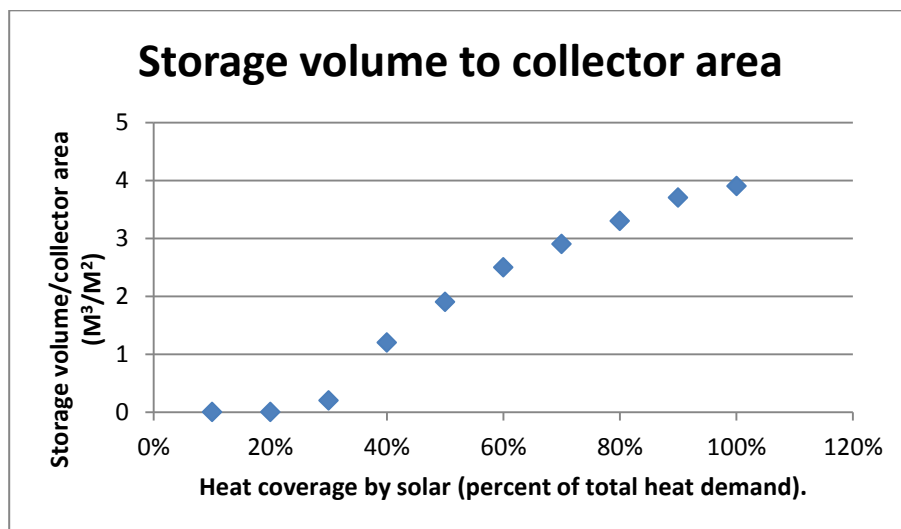

Figure 12 Ratio of seasonal storage volume to collector area (y-axis) as a function of solar heat coverage [4] and [5].

Figure 12 shows calculated data for the seasonal storage requirement as a function of solar heat coverage in the DH system, based on the data sheet below and data for seasonal heat storage in this publication technology catalogue, chapter 60 on seasonal heat storage.

Data sheets

Technology	Solar District Heating									
	2015	2020	2030	2050	Uncertainty (2020)		Uncertainty (2050)		Note	Ref
Energy/technical data					Lower	Upper	Lower	Upper		
Typical plant size (collector area), m ²	10000	13000	21000	55000	10000	20000	10000	100000	L	
Collector input, kWh/m ² /year	1046	1046	1046	1046	1013	1079	1013	1079	Q	
Collector output, kWh/m ² /year	450	473	497	522	450	496	497	548	A	4
Total efficiency , net (%), annual average	43%	45%	48%	50%	42%	49%	46%	54%	P	
Auxiliary electricity consumption (share of heat gen.)	0.3%	0.3%	0.3%	0.3%	0.2%	0.4%	0.2%	0.4%		
Forced outage (%)	0.5%	0.5%	0.5%	0.5%	0%	1%	0%	1%	K	
Technical lifetime (years)	30	30	30	30	30	30	30	30	I	17
Construction time (years)	0.25	0.25	0.25	0.25	0.25	0.25	0.25	0.25		
Space requirement (1000m ² per MWh/year)	6.7	6.3	6.0	5.7	6.0	6.7	5.5	6.0	J	
Environment										
SO ₂ (g per GJ fuel)	0	0	0	0	0	0	0	0		
NO _x (g per GJ fuel)	0	0	0	0	0	0	0	0		
CH ₄ (g per GJ fuel)	0	0	0	0	0	0	0	0		
N ₂ O (g per GJ fuel)	0	0	0	0	0	0	0	0		
Financial data										
Investment cost of total solar systems excluding diurnal heat storage, €/MWh _{output} /year	429	395	362	325	371	422	292	362	C, H, N	
- of which is equipment	85	85	85	85	85	85	85	85	O	
- of which is installation	15	15	15	15	15	15	15	15	O	
Investment cost of diurnal heat storage, €/MWh _{output} /year	60	57	54	52	41	75	37	68	D, M	
Total investment cost of total solar system including diurnal heat storage, €/MWh _{output} /year	489	452	416	377	412	497	329	430	E	
Fixed O&M €/MWh _{output} /year/year	0.09	0.09	0.08	0.08	0.08	0.10	0.07	0.08	B	
Variable O&M €/MWh _{output}	0.19	0.21	0.30	0.35	0.14	0.28	0.23	0.47		
- of which is electricity costs, €/MWh _{output}	0.19	0.21	0.30	0.35	0.14	0.28	0.23	0.47		
- of which is other O&M costs, €/MWh _{output}	0	0	0	0	0	0	0	0		
Technology specific data										
Investment cost of total solar systems excluding diurnal heat storage, €/m ² (collector area)	193	187	180	170	184	190	160	180	G, H, N	16
Fixed O&M, €/m ² /year (collector area)	0.04	0.04	0.04	0.04	0.04	0.05	0.04	0.04	B	

Notes

- A The yield is weather dependent and very site-specific, depending much on the temperatures of the district heating network. The quoted yield the average measured output from 40 Danish solar heating plants for 2015.
- B Estimate is 0,2 €/MWh heat output in 2015, excluding electricity consumption.
- C Applying the formula 250,000 € + 167 €/m² solar panel collector for plants <50.000m², cf. figures from Note G.
- D Including a diurnal storage is mandatory, 0.2 m³/m² being a typical average storage size. This figure can vary, dependent on the local conditions and desired solar fraction.
- E Can be combined with seasonal storage, cf. corresponding chapter.
- F Solar thermal plants can be regulated by varying the flow of the heat transfer fluid. The regulation ability is limited by the available heat demand in the heat sink (incl. available storage capacity) and solar radiation.
- G 2015-Prices of different plant sizes [1]:

Size	m ²	5,000	10,000	20,000	50,000	100,000
Price pr. m ²	€/m ²	216	193	180	175	170
Total price	M€	1.08	1.93	3.60	8.73	17.00

- H Prices include leveling of ground, laying of district heating pipelines in the ground inkl. 50 m of transmission pipeline to the district heating plant, heat exchanger connected to solar panel field and installed with collection tank and expansion with flanges to secondary side, control and electricity works, design and project management, start-up regulation and documentation.
- I The lifetime is minimum 25-30 years, proven in actual plants still in operation. Critical component is the teflon foil, not the material itself, but the application method. The pipes have been improved, designed for the relatively large number of temperature variations, compared to normal district heating pipelines. The fluid is well managed.
- J Space requirement is approximately 3 m² for each m² gross collector area. No development of this parameter is expected, since the main reason is to avoid the shadow effect. Minor optimization of the sides of the panels may be obtained, increasing the ratio of aperture/gross area. Other types of solar collectors such as vacuum and CSP (concentrated solar power) may have lower space requirement.
- K The forced outage is very small, therefore in practice close to 0 %. The modular construction makes it possible to maintain sections of the panels. Outage of critical components such as the heat exchanger is very limited.
- L The average plant size increases, but with large variations since both small plants and increasingly larger plants are installed. A 5 % annual increase of the average size is assumed. The plant size is rather dependent on the heat demand in the district heating grid, it is connected to. The collector area is, cf. international standards, stated as gross area.
- M Estimate of cost of tank storage (diurnal storage) is 135 €/m³. The required size of the storage differs, but a typical size is 0.1-0.3 m³ storage for each m² of solar panels, hence a 10,000 m² solar thermal plant requires 1-3,000 m³ of diurnal storage.
- N Considering a reduction in prices for 2015-2020 / 2020-2030 / 2030-2050 of 0.6 / 0.4 / 0.3 % p.a.
- O The division of cost elements is site- and plant specific. An indicative distribution of costs are; Solar collectors and piping (48%), heat exchanger, pumps etc. (8%), accumulation tank (11%), transmission pipeline (13%), building (2%), control, operation and startup (5%), land purchase, ground works (7%), design, permits, unforeseen (6%). Total for equipment is 85% and for installation is 15% (design, permits, unforeseen, ground works, control and start up), but including accumulation tank and a transmission pipeline.
- P Please refer to www.solvarmedata.dk for display of efficiencies of Danish solar district heating plants. Chose a plant, select "Production and efficiency" and a chart will display the efficiency - typically varying between 20 and 50%.
- Q The solar radiation on the horizontal surface.
- R The cost of auxiliary electricity consumption is calculated using the following electricity prices in €/MWh: 2015: 63, 2020: 69, 2030: 101, 2050: 117. These prices include production costs and transport tariffs, but not any taxes or subsidies for renewable energy.

Definitions

CSP	Concentrated Solar Power
ECT	Evacuated Collector Tubes
FPC	Flat Plate Collector
SDH	Solar District Heating
Specific collector output	Heat production pr. gross collector area (e.g. kWh/m ²)

References

- [1] <http://www.iea-shc.org/solar-heat-worldwide>
- [2] www.solvarmedata.dk
- [3] www.climateminds.dk
- [4] Yearly thermal performance of solar heating plants in Denmark - measured and calculated. *Solar Energy* 159C, pp. 186-196, 2018. Simon Furbo, Janne Dragsted, Bengt Perers, Elsa Andersen, Federico Bava, Kristian Pagn Nielsen
- [5] PlanEnergi, www.planenergi.dk
- [6] GHI Solar Map 2017 Solargis, www.solargis.com
- [7] IEA-SHC TECH sheet 45.A.1
- [8] www.solarkeymark.dk/CollectorCertificates
- [9] www.solarthermalworld.org
- [10] Viessmann GmbH, 2009, *Technical Guide – Solar Thermal Systems*
- [11] Marstal District Heating
- [12] Jan-Olof Dalenbäck, 2014, *Presentation in the SDH-project Solar District Heating Systems State of the Art*
- [13] SDH Guidelines, developed in the SDH-Project. <http://solar-district-heating.eu/Documents/SDHGuidelines.aspx>
- [14] Homepage of the SDH-project, overview of professional partners in the SDH-branch, <http://solar-district-heating.eu/ServicesTools/FindProfessionals.aspx>
- [15] PlanEnergi et. al, 2015, *SUNSTORE 3 Final Report - Phase 2 - Implementation*
- [16] Arcon-Sunmark, personal communication. The projected costs are not from this reference, but estimated based on two components; the lower specific costs of larger plants in 2015 and increased competition among suppliers and more efficient production of solar panels.
- [17] "Life expectancy of solar collectors in solar district heating systems", Department of Civil Engineering, Technical University of Denmark, 2009.

Introduction to Peak Power Plants and Reserve Technologies

Contact information:

Energinet.dk: Rune Grandal, rdg@energinet.dk

Danish Energy Agency: Filip Gamborg, fgb@ens.dk

Author: Ea Energy Analyses

Publication date

November 2018

Amendments after publication date

Date	Ref.	Description

Introduction

This chapter covers data regarding energy plants designed for providing of peak power either in the wholesale market or reserve capacity for the system operator.

The focus is on newly built thermal power plants. Other technologies may in the future provide the same service, such as storage technologies or demand response. However, these technologies are not treated here nor compared to thermal peak power plants. Some of these technologies (e.g. electrical energy storage) are described in a separate technology catalogue.

It is intended as a specific chapter of the *Technology Data for Energy Plants*, thus follows the same structure and data format. The chapter focuses on the assumptions that differ from the main catalogue.

This section provides an introduction, a definition of the services covered and some general assumptions. Each technology is subsequently described in a separate technology chapter. The technology chapters contain both a description of the technologies and a quantitative part including a table with the most important technology data. For some of the technology chapters, the qualitative technology description is brief and only focuses on the specific service described. For additional information, see the respective technologies in the main catalogue (e.g. simple-cycle gas turbines and gas engines).

Definition of the services

The services that are covered in this chapter refer to provision of peak load and reserve.

The **peak load** service, provided by the peak power plants - also referred to as peakers - is defined as the provision of power in the hours with the highest price. It is characterized by few operating hours and is therefore served with technologies characterized by:

- Low capital expenditure (CAPEX)

- High variable cost, mainly in relation to high fuel cost
- Low start-up costs and quick start-up time

The peak power plants regularly bid into the market and appears on the right-hand side of the supply curve as the last units available, due to their high short-term marginal cost. A representation of a potential merit order curve is shown in Figure 1.

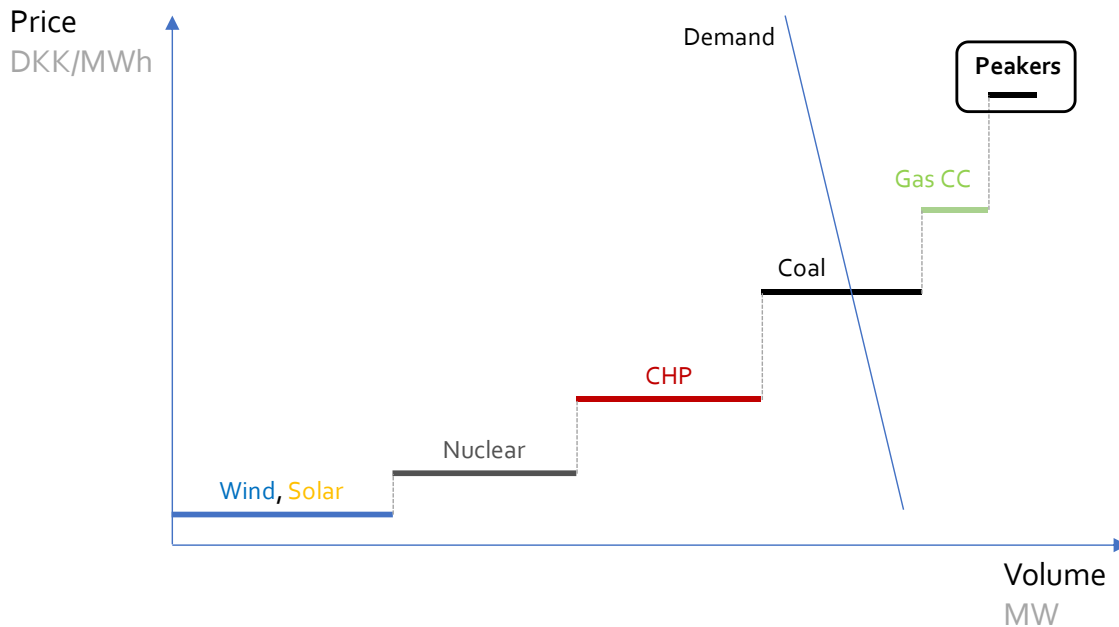

Figure 1 Example of a supply curve (merit-order curve), in which peakers appear on the right side

Figure 2 shows the price duration curve in DK1 and DK2 and a zoom on the highest price hours in DK2. In 2017, the 200 hours with the highest price were all above 57 €/MWh, with peak price of around 120 €/MWh.

With an increasing penetration of variable renewable energy sources (VRES) and a decommissioning of more conventional and dispatchable power plants, it is expected that hours with a high electricity price will increase making more room in the system for peak technologies.

The plants providing this type of service have also the opportunity to participate to balancing markets held by the TSO.

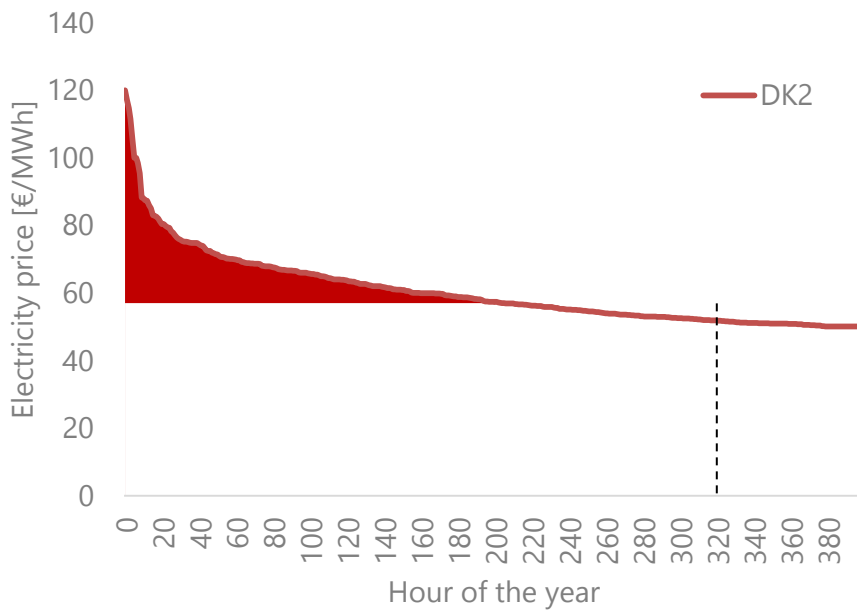
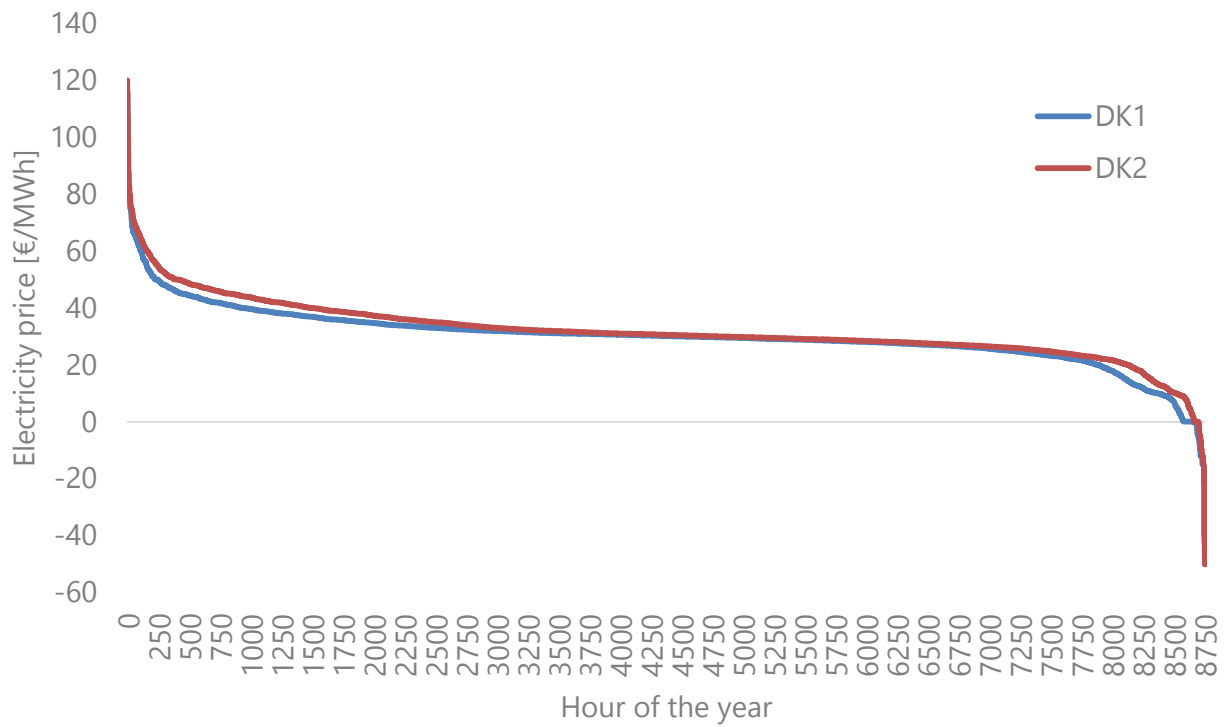

Figure 2 Price duration curve for DK1 and DK2 bid areas (top) and price in the 200 hours with highest price in DK2 (bottom). Data for the year 2017 [1].

The **reserve service (or emergency service)** has similar technical requirements compared to the peak load serving, i.e. fast response and low capital expenditure. However, the reserve service is characterized by the fact that the generator offering this service does not bid into the day-ahead but, instead, make their generation capacity available to the Transmission System Operator (TSO) in case lack of generation or failures in the transmission network triggers a risk for security of supply.

An example of such a service is the strategic reserve adopted in some Nordic countries (Sweden and Finland) and planned in Eastern Denmark (DK2).

The strategic reserve is intended to operate only when the market does not provide sufficient capacity and should therefore be dispatched at a price above a reference level signaling scarcity. In theory, the reserve should only be dispatched at a price close to VoLL (value of lost load) in order not to interfere with the market. In this case the natural price formation on the market is not affected and generators receive the same investment incentive as if there were no strategic reserve.

Capacity for strategic reserves is procured through a tendering procedure for a specified amount of capacity (in MW), for example on a year-to-year basis. The strategic reserve may consist of existing or - provided the auction takes place well in advance of when the contracted capacity should be available - new generation built for the purpose of reserve capacity. The specification of the amount and type of capacity (e.g. peak units) or demand resources may be based on a so-called reliability study [2].

General assumptions

The boundary for both cost and performance data is the generation assets plus the infrastructure required to deliver the energy to the main grid. For electricity, this is the nearest land-based substation of the transmission/distribution grid. In other words, the technologies are described as they are perceived by the electricity system receiving their energy deliveries.

In the calculation and description of technology cost and performance, it is assumed that a typical service is characterized by 200 operating hours, 75% are taking place at full load, while the remaining is characterized by part-load generation.

Due to service envisioned and the low number of operating hours, no investment in environmental facilities to reduce polluting emissions is assumed in this catalogue. Indeed, European directives and relative national Danish implementations exempts plants operating for less than 500 hours a year from complying with the emission limitations. The assumption of no deployment of environmental facilities is therefore valid for all operations below this threshold of 500 hours a year.

More detail on environmental aspects and legislation is available in ANNEX 2: Emissions limitations for peak- and reserve plants.

Co-generation of district heating is not considered for these technologies. Indeed, with 200 operating hours, it is assumed that investments in facilities to collect the heat will not be economically justified²⁰. Moreover, the access to district heating network poses limits to the choice of the location of the emergency plant in the power network.

O&M and Start-up costs

In expressing the operations and maintenance cost for the reserve and peakers technologies in this chapter, the same approach of the main catalogue is used: O&M costs stated in this catalogue includes start-up costs and takes into account a typical number of start-ups and shut-downs. Therefore, the start-up costs specified in the data sheet should not be specifically included in more general analyses. They should only be used in detailed dynamic analyses of the hour-by-hour load of the technology. For all three peaking technologies 50 start-ups a year is assumed to be representative.

Maintenance on engines and OCGT turbines is generally done according to a maintenance schedule that is based on a certain number of total running hours. This means that a plant with very few annual operating hours will have a low variable cost until it reaches one of the bigger schedules. With the 200 hours a year assumed, the large maintenance window will not be reached in the lifetime of the plant, reducing maintenance costs and scheduled downtime, compared to a plant with more full load hours a year. Another driver for a lower O&M cost compared to a baseload or intermediate plant is the possibility to monitor and operate the plant remotely, removing the need for permanent staff on site.

Technologies assessed and qualitative comparison

The technologies considered to provide peak and reserve service diesel engines, natural gas engines and open cycle gas turbines.

Figure 3 shows a qualitative comparison of the technologies presented in this chapter across the main parameter. It has to be noted that this is an indicative ranking based on the central estimate values and it can vary depending on specific applications.

²⁰ As a reference, the extra investment cost of adding district heating equipment to an engine for cogeneration purposes is around 50-100 €/kW.

	CAPEX	OPEX	Efficiency	Emissions	Dynamic performance
Best ↑	Diesel engine farm	Natural gas engine plant	Natural gas engine plant	Natural gas engine plant	Diesel engine farm
	Open Cycle Gas Turbine	Open Cycle Gas Turbine	Open Cycle Gas Turbine	Open Cycle Gas Turbine	Natural gas engine plant
Worst ↓	Natural gas engine plant	Diesel engine farm	Diesel engine farm	Diesel engine farm	Open Cycle Gas Turbine

Figure 3 Qualitative comparison of technologies described in the chapter, across the five main parameters.

Diesel engine farms present the lowest level of CAPEX and good dynamic performance, with short start-up time and flexible operation. On the other hand, they perform less well on efficiency, operational costs and emissions. *Natural gas engine plants* have high efficiencies even at lower loads, low emissions and operational costs, good dynamic performance, but are the most expensive solution. Finally, *Open cycle gas turbines* presents a medium level of capital and operational costs, have the worst dynamic performance, especially in terms of start-up time and ramp rates and features a reduced efficiency and increased emissions at part load.

Forecasting future costs

Historic data shows that the cost of most electricity production technologies has been reduced over time. It can be expected that further cost reductions and improvements of performance will also be realized in the future. Such trends are important to consider for future energy planning and therefore need to be taken into account in the technology catalogue.²¹

For projection of future financial costs there are three overall approaches: Engineering bottom-up, Delphi-survey, and Learning curves. This catalogue uses the learning curve approach. The reason is, that this method has proved historically robust and that it is possible to estimate learning rates for most technologies. Furthermore, learning curve correlations are well documented, the risk of bias is reduced compared to the alternative approaches. The cost projections are based on the future generation capacity in IEA’s 2 DS and 4 DS scenarios (2017 values are assumed to be a good approximation for 2015) [3].

Learning rates typically vary between 5 and 25%. In 2015, Rubin et al published “A review of learning rates for electricity supply technologies” [4], which provides a comprehensive and up to date overview of learning rates for a range of relevant technologies, among which:

²¹ Based on methodology developed and explained in “Technology Data for the Indonesian Power Sector” [6].

Technology	Mean learning rate	Range of studies
Coal	8.3%	5.6 to 12%
Natural gas CC	14%	-11 to 34%
Natural gas, gas turbine	15%	10 to 22%
Nuclear	-	Negative to 6%
Biomass power	11%	0 to 24%

Table 2 Learning rates from different technologies [4].

The authors of the review emphasize that “methods, data, and assumptions adopted by researchers to characterize historical learning rates of power plant technologies vary widely, resulting in high variability across studies. Nor are historical trends a guarantee of future behaviour, especially when future conditions may differ significantly from those of the past” [4]. Still, the study gives an indication of the level of learning rates, which may be expected. 10-15% seems to be a common level for many technologies, whereas nuclear power and coal are in the lower end.

Considering the uncertainties related to the estimation of learning rates, a default learning rate of 10% is applied for the technologies in this catalogue. The choice of the lower bound reflects the fact that all technologies treated in the catalogue are all mature technologies corresponding to Category 4.

When the abovementioned learning rates are combined with the future deployment of the technologies projected in the IEA scenarios, an estimate of the cost development over time can be deduced.

Technology	Rate	2DS				4 DS				Average of 2 & 4 DS			
		2017	2020	2030	2050	2017	2020	2030	2050	2017	2020	2030	2050
Oil	10%	100%	98%	98%	97%	100%	98%	98%	94%	100%	98%	98%	96%
Natural gas	10%	100%	97%	94%	91%	100%	97%	92%	85%	100%	97%	93%	88%

Table 3 Estimated development of technology costs in the IEA’s 2 and 4 DS scenarios in 2020, 2030 and 2050, relative to 2017. The average of 2DS and 4DS is considered in this catalogue.

References

- [1] Energinet.dk, “Energi Data Service,” 2017. [Online]. Available: <https://www.energidataservice.dk/en/>. [Accessed: 02-Aug-2018].
- [2] EUETS.com, “Strategic reserve as a capacity remuneration mechanism (CRM).” [Online]. Available: www.emissions-euets.com/strategic-reserve.
- [3] IEA, “Energy Technology Perspectives 2016,” 2016.
- [4] E. S. Rubin, I. M. L. Azevedo, P. Jaramillo, and S. Yeh, “A review of learning rates for electricity supply technologies,” *Energy Policy*, vol. 86, pp. 198–218, Nov. 2015.
- [5] D. Santoianni, “Defining true flexibility – a comparison of gas-fired power generating technologies,” *Detail Wärtsilä Tech. J.*, vol. 1, pp. 10–15, 2015.
- [6] T. Data and P. Plants, “Technology Data for the Indonesian Power Sector,” no. December, pp. 1–140, 2017.

50 Diesel Engine Farm

Contact information:

Energinet.dk: Rune Grandal, rdg@energinet.dk

Danish Energy Agency: Filip Gamborg, fgb@ens.dk

Author: Ea Energy Analyses

Publication date

November 2018

Amendments after publication date

Date	Ref.	Description

Qualitative description

Brief technology description

Diesel farms or gensets are blocks of reciprocating diesel engines which includes an electric generator. They provide modular electric generating capacity and come in standardized sizes. Lately, they have been widely used in the United Kingdom (UK) to provide standby power generation for large industrial and commercial sites that cannot afford to lose power in the event of interruptions of the electricity network supply.

Increasingly, they are being built and connected to the network also to provide peak clipping to avoid demand charges. They are able to start-up and reach full load very quickly, which is very useful to National Grid in managing short-term fluctuations and potentially other ancillary services. A typical diesel farm is constituted by a set of containerized diesel engines of various ratings (normally from 400-500 kW up to the MW scale) and a connection to the grid by means of low to medium voltage transformer.

The deployment of this solution for peaking and reserve service has been relevant in United Kingdom following the auctions for capacity market implemented starting from 2014 and those for Short term operating reserve (STOR). One of the reasons for the success of these type of plants is the access to several nested benefits. First of all, they could receive a payment from the capacity market for the availability of their capacity; moreover, they could partially participate to the auctions for STOR.

Additionally, they have access to the so called “embedded benefits”, exempting them to pay the connection charges in light of the fact that they are connected to the distribution grid. Finally, until November 2015, they could access the Enterprise Investment Scheme (EIS) designed to help smaller, higher-risk trading companies raise finance by offering a range of tax reliefs.

Following an internal debate, a reform of embedded benefits is expected in the near future. After the publication of a note stating that this reform could be applied retroactively to new plants once it will enter into force, a large number of proposed diesel farms have been retired from the last round of capacity market auction in December 2017, questioning the future for this solution in UK.

Input

The input is light fuel oil (diesel or biodiesel).

Output

The output is electricity.

Typical capacities

In the latest tender for capacity market and short term operating reserve in the UK, the typical farm size was between 3 MW and 50 MW. However, given the modularity of the solution, it is potentially expandable to higher ratings. A very large number of plants awarded are around 18 – 20 MW, constituted by a variable number of engines rated 400 kW – 2 MW each. This is assumed as the typical capacity of the plant.

Regulation ability and other power system services

The start-up time of diesel generators are amongst the lowest compared to other generation facilities.

A typical figure for the cold start-up time of these types of generators is down to 2-3 minutes. The ramping capabilities are also good, with a typical engine able to provide 50% output in around 15 seconds and full capacity after 5 additional seconds. Part load generation does not result in a large drop of efficiency due to the modular nature of the diesel farm. When the plant has to be regulated downward, some generators can be switched off and each online generator can be kept at the optimal output level (for emissions and efficiency).

Advantages/disadvantages

Advantages and disadvantages of this technology is stated in relation to other peak and reserve options.

Advantages

- Known and proven technology with high reliability
- Minimal impact of ambient conditions (temperature and altitude) on plant performance and functionality
- Very low CAPEX
- High performance and low response time
- High efficiency at part load
- Decentralized option

- Modular solution
- Short construction time
- Option to use biodiesel

Disadvantages

- High air pollutant emissions
- Need for on-site tanks to store diesel
- Relatively low efficiency
- Expensive fuel

Environment

Emissions highly depend on the characteristics of the fuel applied, fuel type and its content of sulphur.

Diesel generators are one of the most polluting sources of electricity. Beside large CO₂ emissions, other pollutants include Nox, SO₂ and particles. The fact that the engines are assumed to run on average for less than 500 hours a year, makes them eligible for exemption to emission limitation by EU directive on medium combustion plants. This results in higher specific emission whenever they are running.

Research and development perspective

Diesel generators have reached technological maturity long ago and, while some developments are still happening in the emission reduction and dynamic performance, the engines used for the services described in this catalogue will most likely not be Best-available-technology, due to the need to keep CAPEX levels low.

Example of market standard technology

Example of market standard diesel farms for the provision of reserve and peak load are represented by the plants built in United Kingdom in the last few years following auctions for capacity market and reserve services. In order to access different revenue streams and participate to e.g. frequency regulation, most of these plants have start-up time as low as 2-3 minutes.

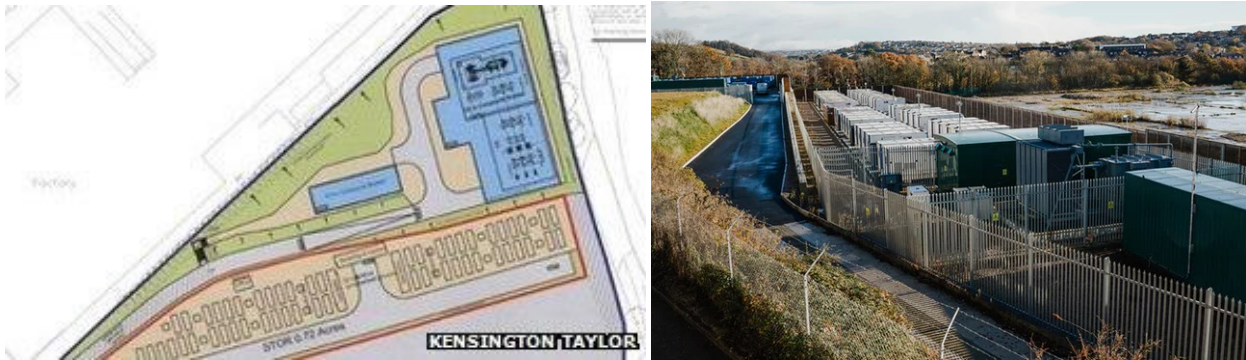

Figure 1 A diesel farm in the Ernesettle area of Plymouth. Photograph: Ben Mostyn for the Guardian.

Figure 1 shows a 20 MW diesel farm built close to Plymouth (UK) and composed of 52 containerized diesel generators, for the provision of STOR service. Smaller 400 kW units have been used.



Figure 2 Emergency plant in Cornwall. Photograph: SEA Trasformatori

Figure 2 shows a similar plant of 20 MW plant built as an emergency reserve in Cornwall (UK), composed of 40 diesel generators and 10 step-up transformers.

Prediction of performance and cost

The technology is classified under the Category 4: Commercial, limited development potential.

Due to technological maturity, a progressive switch to less polluting power sources and the problems of public acceptance, no significant reduction in investment and operation costs are expected in the future.

Some technical improvements can be expected from the manufacturers driven mainly by other applications such as marine propulsion.

Uncertainty

The uncertainty in the quantitative figures mainly relates to the different manufacturers using different models and makes of engines making up the diesel farm.

Additional remarks

The proposal of excluding all plants with specific CO₂ emissions above 550g/kWh from capacity mechanisms payments poses a regulatory risk on future installation of this technology (see ANNEX 2: Emissions limitations for peak- and reserve plants for details).

Data sheet

Technology	Diesel engine farm									
	2015	2020	2030	2050	Uncertainty (2020)		Uncertainty (2050)		Note	Ref
Energy/technical data					Lower	Upper	Lower	Upper		
Generating capacity for one unit (MW)	18								A, B	
Electricity efficiency, net (%), name plate	37	37	37	37	35	39				1, 2, 3
Electricity efficiency, net (%), annual average	35	35	35	35	33	37			C	
Cb coefficient (50°C/100°C)	-	-	-	-						
Cv coefficient (50°C/100°C)	-	-	-	-						
Forced outage (%)	90	90	90	90						4
Planned outage (days per year)	1.2	1.2	1.2	1.2					D, E	5
Technical lifetime (years)	25	25	25	25						
Construction time (years)	1	1	1	1						6
Regulation ability										
Primary regulation (% of full load per 30 seconds)	100	100	100	100					F	6
Secondary regulation (% of full load per minute)	100	100	100	100					F	6
Minimum load (% of full load)	1	1	1	1					G	
Warm start-up time (minutes)	1	1	1	1	0.5	2			H	6, 7
Cold start-up time (minutes)	5	5	5	5	3	10			H	6
Environment										
SO ₂ (g per GJ fuel)	23	23	23	23					I	8
NO _x (g per GJ fuel)	942	942	942	942						8
CH ₄ (g per GJ fuel)	24	24	24	24						8
N ₂ O (g per GJ fuel)	2.1	2.1	2.1	2.1						8
Particles (g per GJ fuel)	5.0	5.0	5.0	5.0						8
Financial data										
Specific investment (M€/MW)	0.350	0.343	0.343	0.336	0.274	0.412	0.235	0.437	M, N, O	1, 6, 9, 10
- of which equipment	0.228	0.223	0.223	0.218					L	
- of which installation	0.123	0.120	0.120	0.118					L	
Fixed O&M (€/MW/year)	8,800	8,800	8,448	8,096					D, P, Q	6
Variable O&M (€/MWh)	6	6	6	6	2.6	8.5	2.6	8.5		11,12,13
Startup cost (€/MW/startup)	-	-	-	-					R	6, 11

Notes

- A The range of generating capacity for a plant based on this technology is typically 10-300 MW. Most of UK projects are in the range 18.5-20 MW. Emission requirements for plants with 18.5 MW and above are regulated by the Danish EPA and it is as of yet undetermined whether and exemption due to low operating hours can be obtained.
- B Engine size is normally in the range 400 kW – 2 MW. Here considered 10 engines of 1.8 MW.
- C Assuming the same efficiency reduction from nameplate to annual average compared to Gas Engines in the main technology catalogue.
- D The routine checks and oil change varies depending on the size. Smaller engines (400 kW) needs it every 250 h, while larger engines (2 MW) needs it every 1000h. Here assumed larger engines. Fixed O&M costs can increase for smaller sizes.
- E 1.5h monthly maintenance for general checks, 4h semiannual, 2h annually, 2h biannually, 6h every 6 years.
- F 50% of the output capacity can be reach within 15 seconds and after 20 seconds the total power output can be provided.
- G Minimum load of the single engine is 30%. In a modular solution, some engines can be switched off to reduce the minimum load of the total plant. This way the performance is maintained at the optimal level.
- H The startup time of the single engine is around 30 seconds. The ynsynchronization of all the machines and the connection to the grid might increase the startup time to 3-10 minutes.
- I Values related to the use of gas oil.
- J Split based on the Engine technology in the main technology catalogue
- K Development of cost follows the assumptions explained in the introduction. 10% learning rate and capacity development based on IEA ETP 2016.
- L The specific investment cost can vary depending on a number of parameters, like size of engines, electrical equipment and other engines characteristics. The specific investment in 2015 from several projects and sources is in the range 0.282-0.456 M€/MW.
- M The uncertainty is estimated based on the cost span of a number of similar observed projects. It is assumed equal to $\pm 20\%$ in 2020 and it increases to $\pm 30\%$ in 2050.
- N Assumed a reduction of 4% in 2030 and 8% in 2050, due to automation of the power plant control and improvement in the operation
- O Assumed two times the reported value for service agreement excluding consumables, to take into account other fixed O&M components.
- P The maintenance schedule is not affected by frequent starts and stops, fuel, or trips as modern combustion engines have the capability to stop and start without limitations or maintenance impact.

References

- [1] Interview with Rolls Royce Power Systems
- [2] C. Breyer. *Fuel-Parity: New very large and sustainable market segments for PV systems*. 2010
- [3] National Grid. *Short Term Operating Reserve – Carbon intensity report*. 2016
- [4] EEA. *Distributed Generation Operational Reliability and Availability Database*. 2004

- [5] Maintenance schedule Caterpillar Emergency generator. Available at: https://ae.usembassy.gov/wp-content/uploads/sites/254/2017/06/stc12017q0002_post-provided-generator-checklist.pdf
- [6] Interview with UK manufacturer: Edina Power UK
- [7] Wärtsilä. *White paper – Combustion engine power plants*. 2011
- [8] Institut for Miljøvidenskab. Emission factors. Available at: <http://envs.au.dk/videnudveksling/luft/emissioner/emission-factors/>
- [9] Timera Energy. *Investment in UK peaking assets*. Available at: www.timera-energy.com/investment-in-uk-peaking-assets
- [10] UK Department for Business, Energy and Industrial Strategy. *Electricity Generation Cost*. November 2016
- [11] EUGINE (European Engine Power Plants Association) questionnaire to their members. Data presented in “*Flexibility Needs and Options for Europe’s Future Electricity System*”, Energy Brainpool, September 2017.
- [12] BEIS. *Electricity Generation cost*. November 2016
- [13] LAZARD. *Levelized cost of energy analysis v11*. November 2017

51 Natural Gas Engine Plant

Contact information:

Energinet.dk: Rune Grandal, rdg@energinet.dk

Danish Energy Agency: Filip Gamborg, fgb@ens.dk

Author: Ea Energy Analyses

Publication date

November 2018

Amendments after publication date

Date	Ref.	Description

Qualitative description

Brief technology description

The description of the natural gas engine technology is presented in the main catalogue. The only difference in the technology used for the service presented here is the lack of district heating connection. Several large engines, which size can vary between 1 and 10 MW, can be combined into a power plant, as shown in Figure 1 **Error! Reference source not found.**

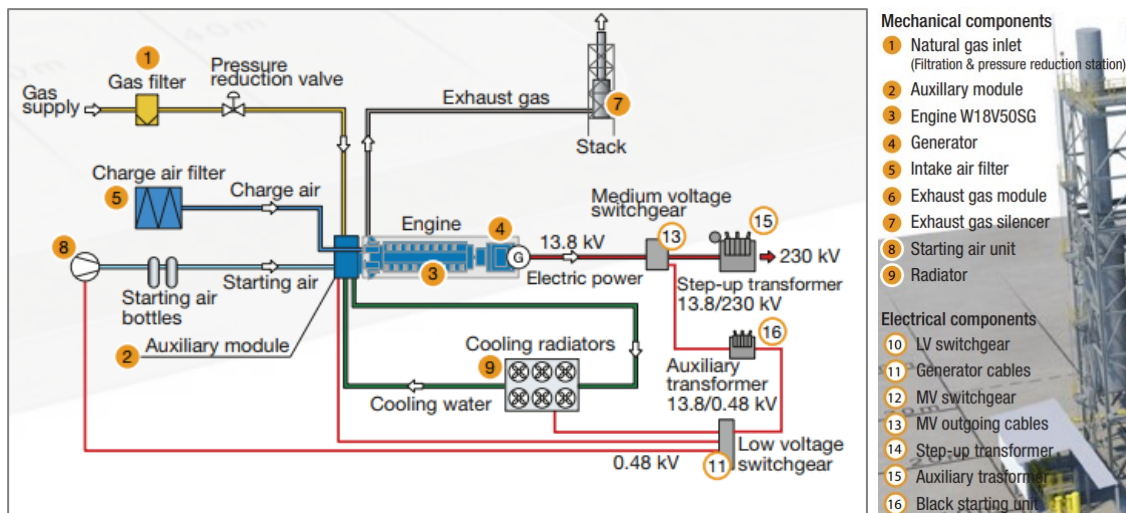

Figure 1 Large engine power plant scheme [16].

The gas engines can be upgraded to handle dual fuel operation, utilizing light fuel oil and natural gas with the capability to switch fuel supply while operating. This increases the reliability of the system at the expense of slightly higher engine cost and the installation of fuel storage tanks on-site.

Increasing need for flexibility and backup following the increasing variable renewable sources penetration, combined with stringent regulations related to emissions of pollutants and CO₂, is expected to lead to the utilization of natural gas plant for emergency and reserve services.

Input

The input is Natural gas with the option to have dual fuel operation with Light Fuel Oil (LFO).

In the future, biogas and biodiesel could be considered as alternative, with low impact on the cost and a slight reduction of efficiency.

Output

The output is electricity.

Typical capacities

Typical capacities for these plants range from 20 MW to 400 MW. The technology is modular and easily scalable.

Regulation ability and other power system services

The response time of gas engines is very low, with new models able to start in one or two minutes.

However, for large plants used in emergency situations and connected to high voltage grid, the temperature of the transformer becomes the largest bottleneck related to ramp-up production. This increases the cold start-up time to 10 minutes.

The reduction of efficiency at part load is much lower compared to open-cycle gas turbines and equal to about 4%-point reduction from full-load efficiency to 30% part-load efficiency.

When running, the ramp rates of engine power plants are very high, corresponding to more than 100% of load per min.

The dynamic characteristics of a gas engine power plant are depicted in Figure 2.

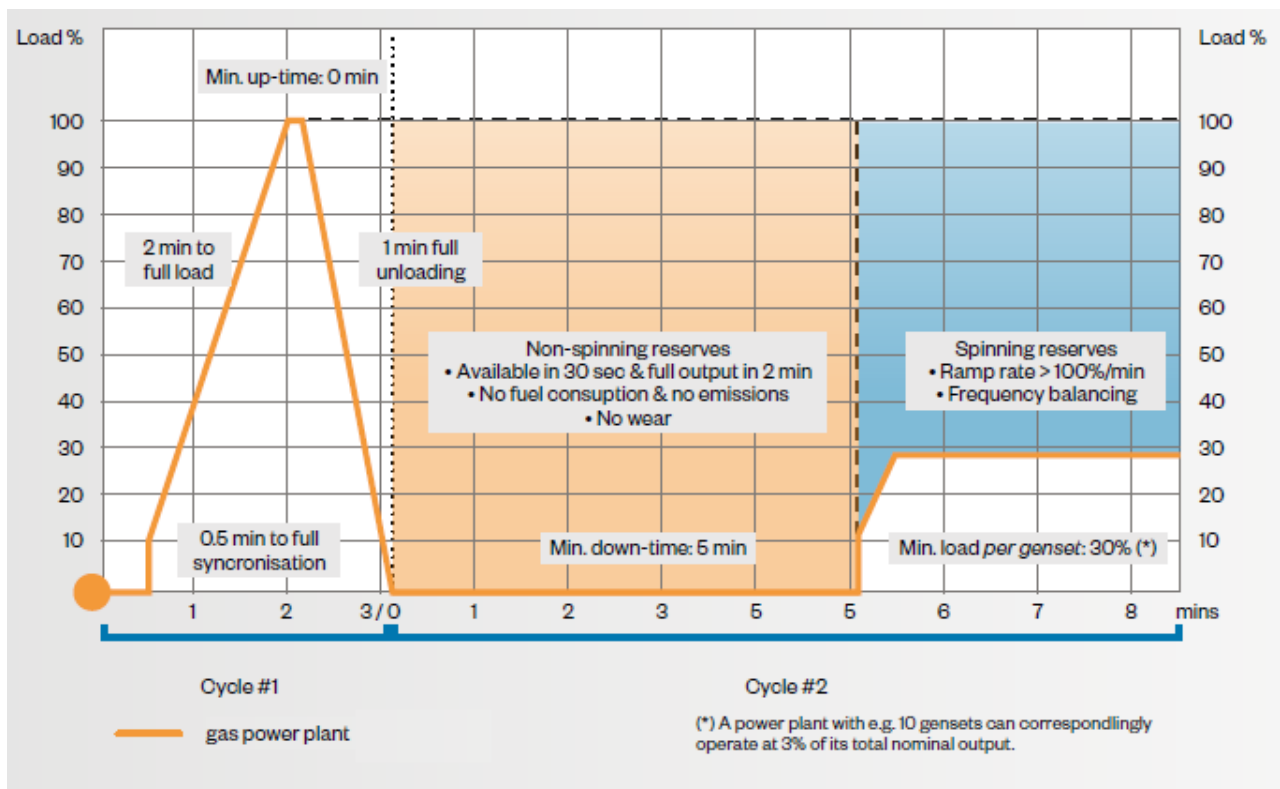

Figure 2 Dynamic characteristic of a gas engine power plant [13].

Advantages/disadvantages

Advantages and disadvantages of this technology is stated in relation to other peak and reserve options.

Advantages

- Known and proven technology with high reliability
- High efficiency
- Modular solution
- High performance and ramp rate and low response time
- Low emission, also at part-load
- Relatively low fixed OPEX
- Possibility of dual fuel operation

Disadvantages

- More expensive than diesel and OCGT solution

- Larger space requirements and installation time than OCGT
- Necessity of connection to the gas grid, with related investment and operational costs
- Higher Nox emission than OCGT at full load

Environment

Gas engines emissions are much lower compared to diesel gensets. Modern gas engine models comply with all industrial emission standards without the need to use catalysts.

A small and inexpensive CO catalyst can be used to limit the CO emissions.

Research and development perspective

The technology is considered mature with small potential for improvement. Some developments are happening in relation to dynamic performance and emissions. The efficiency will also increase slightly due to improvement of the engine design and is expected to reach a value of 50% by 2030.

Example of market standard technology

An example of market standard technology is the Kiisa plant commissioned by Wartsila for the Estonian TSO Elering between 2013 and 2014 [14]. It is an emergency and reserve power plant composed by two units (100+150 MW) for a total of 27 engines rated 10 MW each. The engines are dual fuel and can run on natural gas or light fuel oil.

The plant is remotely controlled from the control center in Tallin and requires no personnel on site. The standby consumption is maintained very low at 200 kW using a air heat pump to keep the equipment warm and ready to start service [15].



Figure 3 Kiisa emergency reserve power plant (ERPP) in Estonia [14].

Prediction of performance and cost

The technology is classified under the Category 4: Commercial, limited development potential.

Some developments can be expected in terms of improved experience in managing the gas engines for reserve purpose and optimization of plant design. However, the impact on cost will be minor.

Uncertainty

The uncertainty in the quantitative figures mainly relates to the different manufacturers and quality of engines utilized.

Data sheet

Technology	Natural gas engine plant									
	2015	2020	2030	2050	Uncertainty (2020)		Uncertainty (2050)		Note	Ref
Energy/technical data					Lower	Upper	Lower	Upper		
Generating capacity for one unit (MW)	200								A, B	
Electricity efficiency (condensation mode for extraction plants), net (%), name plate	48	48	50	50					C	1
Electricity efficiency (condensation mode for extraction plants), net (%), annual average	46	46	48	48					D	2
Cb coefficient (50°C/100°C)	-	-	-	-						
Cv coefficient (50°C/100°C)	-	-	-	-						
Forced outage (%)	0.9	0.9	0.9	0.9						3
Planned outage (days per year)	0.2	0.2	0.2	0.2					E	
Technical lifetime (years)	25	25	25	25					F	
Construction time (years)	1	1	1	1						4, 5
Regulation ability										
Primary regulation (% of full load per 30 seconds)	60	60	60	60					G	6
Secondary regulation (% of full load per minute)	100	100	100	100					G	6
Minimum load (% of full load)	1.5	1.5	1.5	1.5					H	6, 7
Warm start-up time (minutes)	2	2	2	2					I	7
Cold start-up time (minutes)	10	10	10	10					I	7
Environment										
SO ₂ (g per GJ fuel)	0	0	0	0					F	2
NO _x (g per GJ fuel)	75	75	75	75					F	2
CH ₄ (g per GJ fuel)	315	315	315	315					F	2
N ₂ O (g per GJ fuel)	0.6	0.6	0.6	0.6					F	2
Particles (g per GJ fuel)	0.76	0.76	0.76	0.76						8
Financial data										
Specific investment (M€/MW)	0.510	0.495	0.474	0.449	0.396	0.594	0.314	0.583	L, M, N, R	7, 5, 9
- of which equipment	0.332	0.322	0.308	0.292					F	2
- of which installation	0.179	0.173	0.166	0.157					F	2
Fixed O&M (€/MW/year)	6,500	6,500	6,250	6,000					O, P	7
Variable O&M (€/MWh)	6	6	6	6	2.6	8.5	2.6	8.5		10,11,12
Startup cost (€/MW/startup)	0	0	0	0					Q	10

Notes

- A The technology is modular, normally composed by a certain amount of 2-10 MW engines. Here 20 engines of 10 MW are considered.
- B Typical capacity for ultra peakers and emergency plants is in the range 20-300 MW
- C Based on large gas motor (Wartsila 34SG)
- D Assuming the same efficiency reduction from nameplate to annual average compared to main technology catalogue.
- E Based on maintenance schedule of gas engines, considering the reduced number of operating hours and the fact that a typical scheduled maintenance services occurs after 2000, 4000 and 6000 hours, with 1 or 2 days of downtime each. No major maintenance window (16,000 h) is reached.
- F Based on the Gas Engine in the main technology catalogue
- G The values refers to the engine at nominal operating temperature.
- H Minimum load of the single engine is 30%. In a modular solution, some engines can be switched off to reduce the minimum load of the total plant. This way the performance is maintained at the optimal level. Calculation done assuming 20x10MW engines.
- I The engines can startup from warm in 2 minutes. The plant cold startup time is affected by the need to warm up the transformers, which brings it up to 10 minutes. If engines and transformers are hot, the startup time is lower. In case of smaller plants connected to distribution grid, the time to warm up the transformer might not constitute a bottleneck.
- J Dual fuel operation can be considered. Impacting 3-4% of the total plant cost and 7% of engine cost
- K Development of cost follows the assumptions explained in the introduction. 10% learning rate and capacity development based on IEA ETP 2016.
- L The specific investment cost can vary depending on a number of parameters, like size of engines, electrical equipment and other engines characteristics. The specific investment in 2015 from several projects and sources is in the range 0.443-0.616 M€/MW. The lower bound refers to smaller plants with smaller engines, while the higher bound refers to dual fuel plant, located further away from the grid.
- M The fixed O&M cost is lower than a typical value for plants operating >4000 h a year. A typical large maintenance window including reinvestment is carried after 10,000 running hours. Due to the low utilization, this type of plants might never need it in its lifetime, reducing the fixed O&M cost drastically. Additionally the central and lower estimates assume unmanned/remote operation of the plant, whereas the upper boundary assumes manned operation.
- N Assumed a reduction of 4% in 2030 and 8% in 2050, due to automation of the power plant control and improvement in the operation
- O The maintenance schedule is not affected by frequent starts and stops, fuel, or trips as modern combustion engines have the capability to stop and start without limitations or maintenance impact. Modern technology can sustain up to 1000 cycles/years with no significant wear.
- P The uncertainty is estimated based on the cost span of a number of similar observed projects. It is assumed equal to $\pm 20\%$ in 2020 and it increases to $\pm 30\%$ in 2050.

References

- 1 Wartsila. *Power Plant solutions 2016*
- 2 Main technology catalogue: *Technology Data for Energy Plants – August 2016*
- 3 EEA. *Distributed Generation Operational Reliability and Availability Database*. 2004
- 4 Kiisa Power plant project for Elering
- 5 Wartsila. *White paper – Combustion engine power plants*. 2011
- 6 D. Santoianni. *Defining true flexibility – a comparison of gas-fired power generating technologies*. 2015
- 7 Phone interview with Wartsila
- 8 Institut for Miljøvidenskab. Emission factors. Available at:
<http://envs.au.dk/videnudveksling/luft/emissioner/emission-factors/>
- 9 UK Department for Business, Energy and Industrial Strategy. *Electricity Generation Cost*. November 2016
- 10 EUGINE (European Engine Power Plants Association) questionnaire to their members. Data presented in “Flexibility Needs and Options for Europe’s Future Electricity System”, Energy Brainpool, September 2017.
- 11 BEIS. *Electricity Generation cost*. November 2016
- 12 LAZARD. *Levelized cost of energy analysis v11*. November 2017
- 13 D. Santoianni, “Defining true flexibility – a comparison of gas-fired power generating technologies,” *Detail Wärtsilä Tech. J.*, vol. 1, pp. 10–15, 2015.
- 14 Wartsila, “Kiisa ERPP I & II.” [Online]. Available:
<https://www.wartsila.com/energy/references/urope/kiisa-erpp-i-ii>. [Accessed: 08-Feb-2018].
- 15 T. Mahlanen, “Elering Emergency Reserve Power Plant located in Kiisa,” 2011
- 16 Wärtsilä Corporation, “Wärtsilä Power Plants Solutions 2016,” 2016.

52 Open Cycle Gas Turbine

Contact information:

Energinet.dk: Rune Grandal, rdg@energinet.dk
 Danish Energy Agency: Filip Gamborg, fgb@ens.dk
 Author: Ea Energy Analyses

Publication date

November 2018

Amendments after publication date

Date	Ref.	Description

Qualitative description

Brief technology description

Open cycle gas turbines (OCGT), also called simple-cycle turbines, are electricity generating units composed of a compressor, combustion chamber, turbine and a coupled generator.

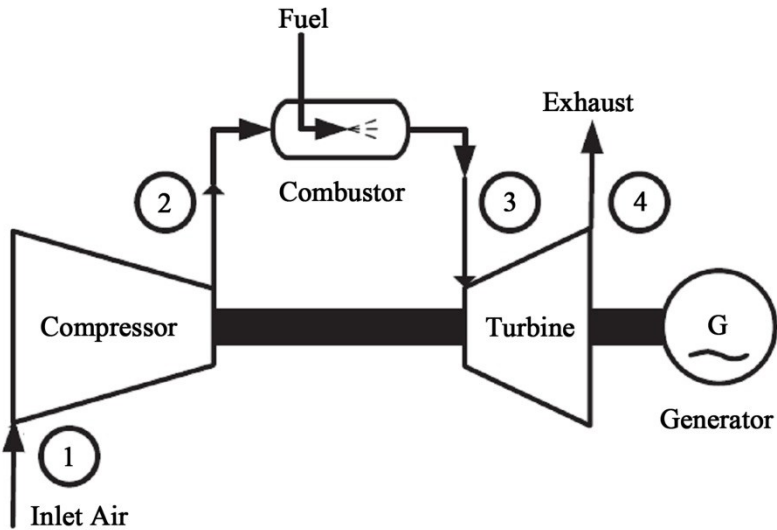

Figure 1 Schematic representation of an Open Cycle Gas Turbine. Figure from: *Scientific Research Open Access*

In power system applications with lower utilization rate and necessity of flexibility, aero-derivative turbines are preferred to heavy industrial ones. Aero-derivative gas turbines are a popular choice for energy generation thanks to their reliability, efficiency and flexibility. Based on advanced aircraft engine technologies and materials, they are significantly lighter, respond faster and have a smaller footprint compared with their heavy industrial GT counterparts. With up to 45% efficiency compared to up to 35% for heavier GTs, these turbines are often seen as a good choice in smaller-scale (up to

100 MW) energy generation [13]. Another feature is their fuel flexibility, allowing a combination of gas and liquid fuel operation.

Input

The input is natural gas or light fuel oil. Some gas turbines are available in dual-fuel versions (gas/oil).

In the future, biogas and biodiesel could be considered as alternative, with low impact on the performance and cost.

Output

The output is electricity.

Typical capacities

Typical capacities of aero-derivative OCGT turbines vary from smaller 5-6 MW turbines to large turbines of 100MW.

For the application described, modular power plant designs composed of smaller turbines are less favourable from an investment cost perspective, since the technology largely benefit from economy of scale. An OCGT-based power plant will therefore most likely be composed by larger aero-derivative turbine (in the range of 50-100 MW) combined for a total output that can reach 200 – 300 MW.

Regulation ability and other power system services

Modern turbines are able to start-up from cold in just under 10 minutes, with some turbines able to start in 7 minutes. In Figure 2, a typical start sequence is represented. When self-sustained speed is reached, the turbine has a ramp rate capability between 0.17 MW/s and 0.8 MW/s, depending on the model. This corresponds to ramp rates of 15-50 MW/min.

Typical average values are around 20 MW/min, while the largest value corresponds to the 118-MW aero-derivative turbine GE-LMS100.

The part-load characteristic of OCGT is limited by a large drop in efficiency at lower loads. On average, the drop is equal to 15% when going from 100% to 50% load [14].

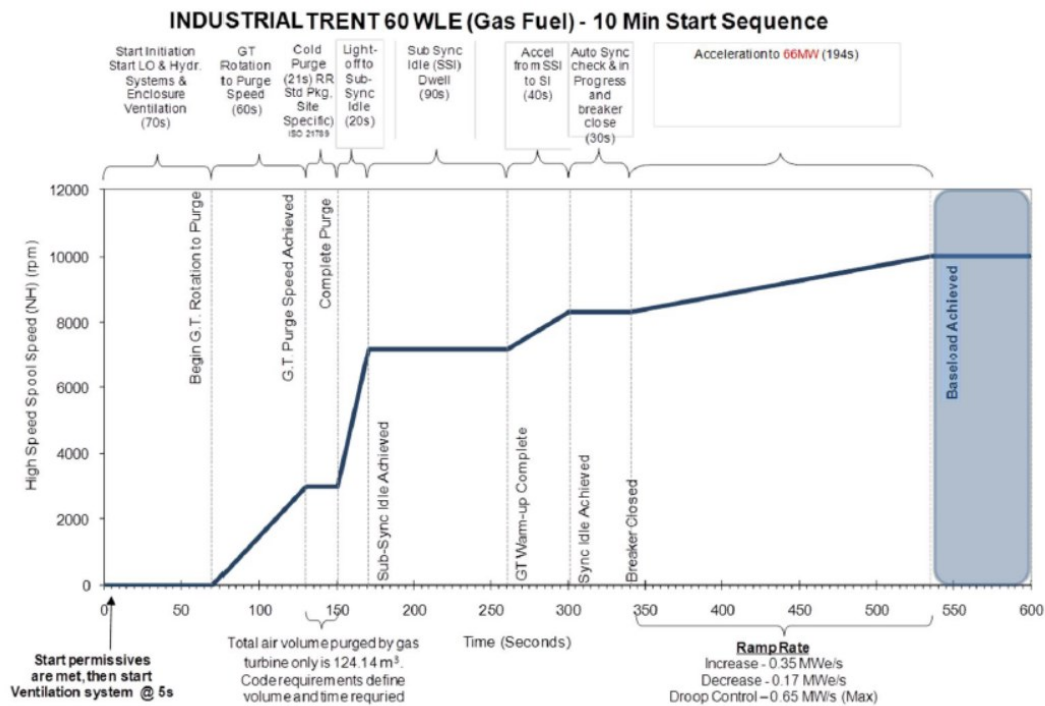

Figure 2 Start sequence and ramp rate of an aero-derivative turbine [15].

Advantages/disadvantages

Advantages and disadvantages of this technology is stated in relation to other peak and reserve options.

Advantages

- Known and proven technology with high reliability
- High performance and low response time
- Higher efficiency than diesel engines at full load
- Short construction time
- Low space requirement
- Low downtime and lower maintenance requirements

Disadvantages

- More expensive than diesel solution
- Lower efficiency than gas engines
- Large reduction of efficiency at part-load

- Not ideal for frequent start and stops
- Open cycle gas turbines requires an input of high pressure gas, which limits potential sites available for open cycle gas turbines to locations in close proximity to the gas transmission grid.

Environment

Gas turbines have continuous combustion with non-cooled walls. This means a very complete combustion and low levels of emissions (other than NO_x). Developments focusing on the combustors have led to low NO_x levels [11].

The use of light fuel oil instead of natural gas increases the emissions from the turbine, particularly SO₂, Nox and particles.

Research and development perspective

Increased efficiency for simple-cycle gas turbine configurations has also been reached through inter-cooling and recuperators. Research into humidification (water injection) of intake air processes (HAT) is expected to lead to increased efficiency due to higher mass flow through the turbine.

Additionally, continuous development for less polluting combustion is taking place. Low-NO_x combustion technology is assumed. Water or steam injection in the burner section may reduce the NO_x emission, but also the total efficiency and thereby possibly the financial viability. The trend is more towards dry low-NO_x combustion, which increases the specific cost of the gas turbine [11].

Example of market standard technology

An example of reserve power plant using OCGT turbines is the Forssa Power Plant, a 318 MW plant commissioned in 2012 for the Finnish TSO Fingrid. It is constituted by two unit of 159 MW each, the fuel used is Light Fuel Oil and the plant is controlled remotely from Fingrid's Main Grid Control Centre in Helsinki. The reported total cost for the plant was 111 million euros²² [16].

²² Converting the value to 2015€ (from 2010€) and expressing the value in relative terms, this corresponds to an investment cost of 0.39 M€/MW.



Figure 3 Forssa Power plant commissioned for Fingrid [17].

Prediction of performance and cost

Gas turbine technology is a well-proven commercial technology with numerous power generating installations worldwide, making simple cycle gas turbines a category 4 technology. The cost development will be favoured by an increase in the installation of natural gas generation, mainly to balance the increase in VRES generation worldwide, while the learning rates will be moderate.

Uncertainty

Uncertainty stated in the tables both covers differences related to the power span covered in the actual table and differences in the various products (manufacturer, quality level, extra equipment, service contract guarantees etc.) on the market.

Data sheets

Two data sheets are provided for the OCGT: the first is the natural gas fired plant and the second LFO fired one. In the second sheet, only the differences with the first sheet are displayed. All other data can be considered equal to the gas-fuelled plant.

Technology	Open cycle gas turbine – natural gas									
	2015	2020	2030	2050	Uncertainty (2020)		Uncertainty (2050)		Note	Ref
Energy/technical data					Lower	Upper	Lower	Upper		
Generating capacity for one unit (MW)	100	100	100	100					A	
Electricity efficiency, net (%), name plate	41	42	43	45					B, C	1, 2
Electricity efficiency, net (%), annual average	39	40	41	43					C	3
Cb coefficient (50°C/100°C)	-	-	-	-						
Cv coefficient (50°C/100°C)	-	-	-	-						
Forced outage (%)	1.4	1.4	1.4	1.4						4
Planned outage (days per year)	0.75	0.75	0.75	0.75					D	1
Technical lifetime (years)	25	25	25	25					E	3
Construction time (years)	0.2	0.2	0.2	0.2					F	5
Regulation ability										
Primary regulation (% of full load per 30 seconds)	30	30	30	30					G	5
Secondary regulation (% of full load per minute)	30	30	30	30	15	50			H	5, 6, 7
Minimum load (% of full load)	25	20	20	20					I	8
Warm start-up time (minutes)	5	5	5	5	4.5	6.5				8, 9, 10
Cold start-up time (minutes)	10	10	10	10	7	11			L	1, 6, 8
Environment										
SO ₂ (g per GJ fuel)	0.43	0.43	0.43	0.43						11
NO _x (g per GJ fuel)	48	48	48	48						11
CH ₄ (g per GJ fuel)	1.7	1.7	1.7	1.7						11
N ₂ O (g per GJ fuel)	1.0	1.0	1.0	1.0						11
Particles (g per GJ fuel)	0.1	0.1	0.1	0.1						11
Financial data										
Specific investment (M€/MW)	0.468	0.454	0.435	0.412	0.363	0.545	0.288	0.535	M,N,O	7, 9, 10
- of which equipment	0.365	0.354	0.339	0.321						12
- of which installation	0.103	0.100	0.096	0.091						12
Fixed O&M (€/MW/year)	8,068	8,068	7,745	7,423					P	9
Variable O&M (€/MWh)	4.5	4.5	4.5	4.5	3.5	5	3.5	5		5, 9, 10
Startup cost (€/MW/startup)	43	43	43	43						9

Notes

- A The range of generating capacity for a power plant based on this technology is typically 50-200 MW. Large aeroderivative gas turbines have a rating of 20-100 MW.
- B The efficiency is drastically reduced at part-load. The difference between efficiency at full load and part load is on average 15%.
- C Based on the Simple Cycle Turbine in the main technology catalogue. No improvement assumed in the future
- D Considering one service per year for borescope inspection (18h). No major maintenance intervals reached, due to low utilization.
- E Lifetime most likely >25years, given low utilization
- F Some manufacturers' offers pre-assembled mobile packages with installation in 30 days.
- G Based on a droop control of 0.65 MW/s of an Industrial Trent 60 (66MW) turbine at self-sustained speed.
- H Based on a gas turbine at self-sustained speed. Ramp rates of 15 MW/min to 50 MW/min.
- I The minimum emissions-compliant load is around 50%, but in case emission regulations do not apply, this can be lower. The efficiency is reduced at part-load (roughly 15%)
- J The lower bound of 7 minutes might be increased to 10 minutes if the plant is connected to high voltage and transformer needs to warm up before starting operations, similarly to Natural gas engine plants.
- K Development of cost follows the assumptions explained in the introduction. 10% learning rate and capacity development based on IEA ETP 2016.
- L The specific investment cost can vary depending on a number of parameters, like size of turbine, electrical equipment and other characteristics. The specific investment in 2015 from several projects is in the range 0.400-0.570.
- M The uncertainty is estimated based on the cost span of a number of similar observed projects. It is assumed equal to $\pm 20\%$ in 2020 and it increases to $\pm 30\%$ in 2050.
- N Assumed a reduction of 4% in 2030 and 8% in 2050, due to automation of the power plant control and improvement in the operation

Technology	Open cycle gas turbine - light fuel oil									
	2015	2020	2030	2050	Uncertainty (2020)		Uncertainty (2050)		Note	Ref
Energy/technical data					Lower	Upper	Lower	Upper		
Generating capacity for one unit (MW)										
Electricity efficiency, net (%), name plate	-1	-1	-1	-1	-0.5	1			A	18
Electricity efficiency, net (%), annual average	-1	-1	-1	-1	-0.5	1			A	18
Cb coefficient (50°C/100°C)	-	-	-	-						
Cv coefficient (50°C/100°C)	-	-	-	-						
Forced outage (%)										
Planned outage (days per year)										
Technical lifetime (years)										
Construction time (years)										
Regulation ability										
Primary regulation (% of full load per 30 seconds)										
Secondary regulation (% of full load per minute)										
Minimum load (% of full load)										
Warm start-up time (minutes)	+0.5	+0.5	+0.5	+0.5					A	18
Cold start-up time (minutes)	+0.5	+0.5	+0.5	+0.5					A	18
Environment										
SO ₂ (g per GJ fuel)	23	23	23	23					B	11
NO _x (g per GJ fuel)	230	230	230	230					B	11
CH ₄ (g per GJ fuel)	3	3	3	3					B	11
N ₂ O (g per GJ fuel)	0.6	0.6	0.6	0.6					B	11
Particles (g per GJ fuel)	5.0	5.0	5.0	5.0					B	11
Financial data										
Specific investment (M€/MW)	0.390	0.378	0.363	0.343	0.303	0.454	0.240	0.446	C, D	19
- of which equipment	0.304	0.295	0.283	0.268						20
- of which installation	0.086	0.083	0.080	0.076						20
Fixed O&M (€/MW/year)										
Variable O&M (€/MWh)										
Startup cost (€/MW/startup)										

Notes

- A Value indicate the estimated change from the correspondent value of natural gas fuelled plant (unit is the same as the paramter).
- B Emission values for Gas Oil. If Residual Oil used, SO₂ emissions increased to 100g, NO_x reduced to 138g and Particles to 3g.
- C Development of cost follows the assumptions explained in the introduction. 10% learning rate and capacity development based on IEA ETP 2016. Same development as natural gas fuelled plant, since the technology is the same.
- D The uncertainty is estimated based on the cost span of a number of similar observed projects. It is assumed equal to ±20% in 2020 and it increases to ±30% in 2050.

References

- [1] GE – Aeroderivative turbines product brochures.
- [2] Siemens – Aeroderivative turbine brochures
- [3] Main technology catalogue: Technology Data for Energy Plants – August 2016
- [4] EEA. Distributed Generation Operational Reliability and Availability Database. 2004
- [5] M. Welch, T.Krol. Flexible Power Generation for Grid Support utilizing Aero-derivative Gas Turbine Technology. 2016
- [6] EU Turbines. Gas and Steam Turbines Solutions for a sustainable energy mix (brochure). 2017
- [7] Forssa Power plant for Fingrid. Available at: www.fingrid.fi/en/pages/news/news/2013/fingrids-new-reserve-power-plant-inaugurated-in-forssa/
- [8] Agora Energiwende. Flexibility in thermal power plants. 2017
- [9] Energy Brainpool. Flexibility Needs and Options for Europe’s Future Electricity System. September 2017.
- [10] Phone interview with Siemens Turbomachinery UK
- [11] Institut for Miljøvidenskab. Emission factors. Available at: <http://envs.au.dk/videnudveksling/luft/emissioner/emission-factors/>
- [12] ESMAP. Technical paper: Study of Equipment Prices in the Power Sector. 2009
- [13] R. Drew, “Flexibility, footprint and reliability advance aeroderivative turbines in a challenging market,” International Turbomachinery, 2017. [Online]. Available: <https://www.turbomachinerymag.com/aeroderivative-gas-turbines/> [Accessed: 08-Feb-2018]
- [14] Energy Brainpool, “Flexibility needs and options for Europe’s future electricity system,” 2017.
- [15] M. Welch and T. Kroll, “Flexible Power Generation for Grid Support utilizing Aero-derivative Gas

Turbine Technology.”

- [16]Fingrid, “Fingrid’s new reserve power plant inaugurated in Forssa,” 2013. [Online]. Available: <https://www.fingrid.fi/en/pages/news/news/2013/fingrids-new-reserve-power-plant-inaugurated-in-forssa/>
- [17]ColGrass, “Forssa Power Plant.” [Online]. Available: <http://www.colgrass.it/en/works/forssa-power-plant-finland.html>.
- [18]Phone interview with Siemens Turbomachinery UK
- [19]Forssa Power plant for Fingrid. Available at: www.fingrid.fi/en/pages/news/news/2013/fingrids-new-reserve-power-plant-inaugurated-in-forssa
- [20]ESMAP. *Technical paper: Study of Equipment Prices in the Power Sector*. 2009

ANNEX 1: FEATURES OF STEAM EXTRACTION TURBINES

With an extraction steam turbine, all steam may be condensed (e.g. by sea water) to generate maximum electricity (P_C), or all steam may be extracted to be condensed at a higher temperature to generate district heat (Q_B). In the latter case, full back-pressure mode (point B in the below figure), some electricity generation is lost ($P_C - P_B$).

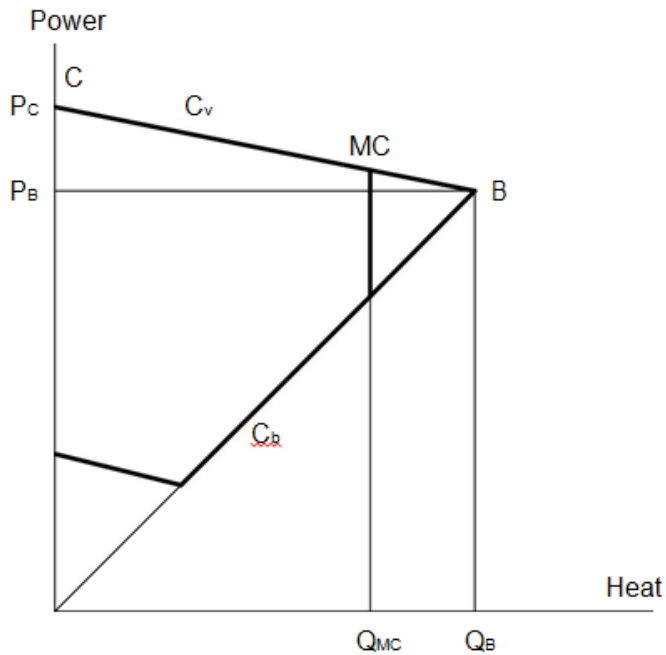

With the steam boiler at full capacity, the turbine may be operated at all points along the line C-B. In the real world, C-B may not be a straight line, but a linear relationship is a good proxy.

By varying full input and steam extraction, the generation of electricity and heat may in theory be varied within the area limited by lines C-B and origo-B. However, in practice there is a minimum power generation capacity (e.g. 10-20% of P_C), and the maximum heat generation capacity may be lower than Q_B .

Below, some relationships are given for key variables.

P_C : Power capacity in full condensation mode; point C. No heat production.

$\eta_{e,c}$: Electricity efficiency in full condensation mode.

Q_B : Heat capacity in full back-pressure mode (no low-pressure condensation); point B.

P_B : Power capacity in full back-pressure mode.

$$\eta_{tot,MC} = \eta_{e,c} \cdot \left\{ 1 + \frac{1 - c_v}{c_b + c_v} \cdot \frac{Q_{MC}}{Q_B} \right\}$$

Q_{MC} : Heat capacity at minimum low-pressure condensation; point MC.

c_v : Loss of electricity generation per unit of heat generated at fixed fuel input; assumed constant.

c_b : Back-pressure coefficient (electricity divided by heat); assumed constant.

The fuel consumption H for any given combination of power generation (P) and heat generation (Q):

$$H = \frac{P + c_v \cdot Q}{\eta_{e,c}}$$

$\eta_{e,B}$: Electricity efficiency in full back-pressure mode:

$$\eta_{e,B} = \eta_{e,c} \cdot \frac{c_b}{c_b + c_v}$$

$\eta_{q,B}$: Heat efficiency in full back-pressure mode:

$$\eta_{q,B} = \frac{\eta_{e,c}}{c_b + c_v}$$

$\eta_{tot,B}$: Total efficiency (electricity plus heat) in full back-pressure mode:

$$\eta_{tot,B} = \eta_{e,c} \cdot \frac{1 + c_b}{c_b + c_v}$$

$\eta_{e,MC}$: Electricity efficiency at minimum low-pressure condensation:

$$\eta_{e,MC} = \eta_{e,c} \cdot \left\{ 1 - \frac{c_v}{c_b + c_v} \cdot \frac{Q_{MC}}{Q_B} \right\}$$

$\eta_{q,MC}$: Heat efficiency at minimum low-pressure condensation:

$$\eta_{q,MC} = \frac{\eta_{e,c}}{c_b + c_v} \cdot \frac{Q_{MC}}{Q_B}$$

$\eta_{tot,MC}$: Total efficiency (electricity plus heat) at minimum low-pressure condensation:

Example:

Electricity efficiency in full condensation mode = 45%, $c_v = 0.15$, $c_b = 1$ and $Q_{MC}/Q_B = 0.7$.

This gives the following values in point B:

Electricity efficiency = 39.1%

Heat efficiency = 39.1%

Total efficiency = 78.3%

While in point MC:

Electricity efficiency = 40.9%

Heat efficiency = 27.4%

Total efficiency = 68.3%

ANNEX 2: Emissions limitations for peak- and reserve plants

The emissions of thermal power plants are regulated at European level, through a number of Directives from the European Union and the subsequent national legislative implementation.

The two main directives to target emission from industrial combustion plants are:

- *Medium Combustion Plant (MCP) Directive*²³, which covers smaller plants;
- *Industrial Emission Directive (IED)* for larger plants.

Directive (EU) 2015/2193 of the European Parliament and the Council of 25 November 2015 on the limitation of emissions of certain pollutants into the air from medium combustion plants ([Medium Combustion Plant Directive](#)) regulates pollutant emissions from the combustion of fuels in plants with a rated thermal input equal to or greater than 1 megawatt (MWth) and less than 50 MWth. The directive regulates emissions of SO₂, NO_x and dust into the air with the aim of reducing those emissions and the risks to human health and the environment they may cause. It also lays down rules to monitor emissions of carbon monoxide (CO).

The emission limit values set in the MCP Directive will have to be applied from 20 December 2018 for newly built plants.

The directive includes the possibility to introduce exemptions from compliance, as a decision of each Member State:

“Member States may exempt existing medium combustion plants which do not operate more than 500 operating hours per year, as a rolling average over a period of five years, from compliance with the emission limit values”

The Danish implementation (*MCP-bekendtgørelsen*²⁴) sets emission levels for medium size combustion plants (1-50 MWth) in accordance with both EU directives, and the implemented Danish requirements for NO_x, which are stricter than the directive. Refer to appendices in the Danish directive for current emission limitations. New power plants²⁵ are subject to regulation, including new peakers. For exceptions see §3. A relevant exception to the regulation is new reserve plants operating less than 500 hours per year on a 3-year rolling average. Such plants do not need to follow regulation on SO₂, NO_x, dust and CO. However, if running on solid fuel, these plants must stay below dust emissions of 100 mg/Nm³ at 6% oxygen.

²³ See more at: <http://ec.europa.eu/environment/industry/stationary/mcp.htm>

²⁴ Available online at: <https://www.retsinformation.dk/eli/ta/2017/1478>

²⁵ defined as plants put into operation after 20 December, 2018.

Large plants (>50 MWth) are covered by the EU Industrial Emission Directive (IED, n. 2010/75/EU), which has been adopted in Denmark through the document *Store fyringsanlæg bekendtgørelsen*²⁶ and it is effectuating limitations on emissions. The Danish directive targets all larger plants and engines besides diesel engines and soda boilers.

Moreover, similarly to the *MCP-bekendtgørelsen*, large plants for emergency situations operating less than 500 hours are also exempted from the emission limits.

Whether a plant is peak or reserve (emergency situations) is determined through the given definitions (§4.20 and §4.23):

Emergency plant: *Medium-sized combustion plants kept in readiness and only put into operation if the commonly used generation plants fails, or in the event of a failure in the transmission network*²⁷.

Peak load plant: *Combustion plant which can be quickly started and stopped to supplement the normal supply of district heating and electricity to make up for the fluctuations in district heating or electricity consumption*²⁸.

As of this writing, there is no clear definition of whether a plant could provide the reserve and peaker service interchangeably. This will be later addressed in an appendix to the directive by Miljøstyrelsen²⁹.

Proposal for a Regulation of the European Parliament and of the Council on the internal market for electricity (recast), 30.11.2016, COM (2016) 861 final 2016/0379 (COD):

A proposal to limit the access to capacity mechanisms to technologies with lower CO₂ emissions has been proposed as part of the *Winter Package*. It states:

“Generation capacity for which a final investment decision has been made after [OP: entry into force] shall only be eligible to participate in a capacity mechanism if its emissions are below 550 gr CO₂/kWh. Generation capacity emitting 550 gr CO₂/kWh or more shall not be committed in capacity mechanisms 5 years after the entry into force of this Regulation”

This would apply to strategic reserve, since it is defined as a capacity mechanism, leaving room only for gas technologies and the very efficient diesel generators. The potential entry into force of this amendment poses a serious regulation risk for new investments in less efficient and more polluting diesel farms.

²⁶ Available online at: <https://www.retsinformation.dk/Forms/R0710.aspx?id=180091>

²⁷ “**Nødanlæg:** Mellemstore fyringsanlæg, der holdes i beredskab og kun sættes i drift, hvis det normalt benyttede anlæg havarerer, eller ved udfald af transmissionsnettet”.

²⁸ “**Spidslastanlæg:** Fyringsanlæg, som ved udsving i fjernvarme- eller elforbruget kan supplere leveringen af fjernvarme eller el fra den normale forsyning, og som hurtigt kan startes og stoppes.”

²⁹ As for phone communication with Miljøstyrelsen (December 2017).

The discussion related to the acceptance of the proposal is an ongoing debate topic at EU level and has recently been part of the discussions in the EU28 energy ministers summit (18 December 2017).

The ministers also proposed to supplement the 550gr limit with an alternative limit of “700kg of CO₂ per installed kW per year”, which would allow more polluting plants to remain subsidized when running for a limited number of hours per year³⁰. This limit corresponds to 1400 operating hours per year for a power plant with an emission factor of 500 gr CO₂/kWh.

For reference, an overview of CO₂ emissions from the different type of plants and fuels is shown in Figure 1.

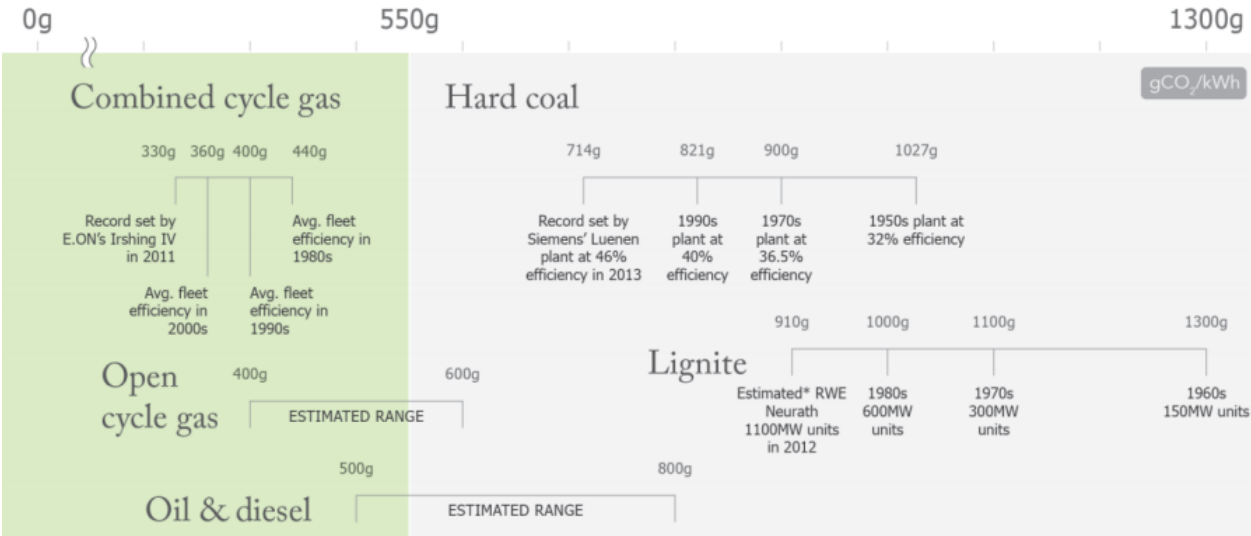

Figure 1 Assessment of carbon-intensity levels by fossil technology [1].

³⁰ See: <https://www.euractiv.com/section/electricity/news/brussels-muddies-waters-on-state-aid-for-coal-power>

References

[1] Sandbag, "Capacity payments and 550g - Why is a carbon-intensity threshold needed for Capacity Payments?," 2017.