

Technology Data

Renewable fuels



Technology Data – Renewable fuels

First published 2017 by the Danish Energy Agency and Energinet,

E-mail: teknologikatalog@ens.dk, Internet: <http://www.ens.dk/teknologikatalog>

Production: Danish Energy Agency and Energinet

Front page design: Filip Gamborg

Front cover photo: Colourbox.dk

Version number: 0008

Amendment sheet

Publication date

Publication date for this catalogue “Technology Data for Renewable Fuels” is June 2017.

Amendments after publication date

All updates made after the publication date will be listed in the amendment sheet below.

Date	Ref.	Description
04 2022	Chapter 105	Slow pyrolysis added
04 2021	Chapter 104	Methane pyrolysis added
04 2021	Chapter 86,87,88	The three chapters on electrolysis (86 Solid Oxide Electrolyzer Cell, 87 Low Temperature Proton Exchange Membrane Electrolyzer Cell (LT PEMEC), and 88 Alkaline Electrolyzer Cell) have been replaced with one chapter (Chapter 86). Both text and data sheets have been updated.
02 2021	Chapter 103	Green Ammonia production added
07 2020	Chapter 102	Minor adjustment in DH output for hydrogen to jet, note letters fixed and note added
05 2020	Chapter 102	Power to Jet added.
02 2019		Minor corrections to text in all chapters. New figures and tables in introduction. Version number added to front page.
02 2019	Chapter 101	Financial data added for configuration 1 (catalytic hydrolysis)
02 2019	Chapter 85+96	The two chapters 85 and 96 on biofuels from gasification + Fischer Tropsch have been merged to one chapter that is now Chapter 85.
12 2018	Chapter 101	Catalytic Hydrolysis added
12 2018	Chapter 89-100	Datasheets revised
09 2018	Chapter 89, 90, 91, 92, 93, 94, 95, 96, 97, 98, 99, 100	Large update, with addition of 11 technologies.
03 2018	Chapter 83,84,85	Thermal gasification added.
03 2018	Chapter 86,87,88	Electrolysis added.

The newest version of the catalogue will always be available from the Danish Energy Agency’s web site.

Preface

The *Danish Energy Agency* and *Energinet*, the Danish transmission system operator, publish catalogues containing data on technologies for energy carrier generation and conversion. This current catalogue includes technologies for energy carrier generation and conversion.

Table of Contents

Introduction	6
81 Biogas Plants.....	29
82 Biogas Upgrading	45
Biomass Gasification - general introduction	56
83 Biomass gasification, fixed bed, for producer gas	59
84 Biomass gasification for bio-SNG	70
85 Liquid fuels from biomass gasification and Fischer Tropsch	81
86 Hydrogen production via electrolysis.....	94
89 Vegetable Oil FAME	119
90 UCO and Animal Fat FAME.....	129
91 Hydrogenated Vegetable Oil / Renewable Diesel.....	139
92 HVO Jet Fuel	151
93 1 st Generation Ethanol	161
94 Pyrolysis Oils.....	172
95 Cellulosic Ethanol.....	182
97 Methanol from Biomass Gasification	195
98 Methanol from Power	205
99 SNG from Methanation of Biogas	215
100 Hydrothermal Liquefaction	225
101 Catalytic Hydrolysis	236
102 Power to Jet Fuel	249
103 Green Ammonia.....	272
104 Methane pyrolysis	299
105 Slow Pyrolysis	316

Introduction

This catalogue presents technologies for generation and conversion of energy carriers. In particular: production of hydrogen by means of electrolysis, biofuels from biomass and production/upgrade of biogas/syngas.

Most of the process are characterised by multiple inputs and multiple outputs, which include for example different fuels/feedstocks, electricity and process heat (recoverable or lost).

Upstream and downstream processes are not included - the datasheets do not provide information on prices for fuels, environmental impact from fuel procurement, or the economic consequences of the substitution of fossil fuels with liquid fuels produced from biomass.

The main purpose of the catalogue is to provide generalized data for analysis of energy systems, including economic scenario models and high-level energy planning.

These guidelines serve as an introduction to the presentations of the different technologies in the catalogue, and as instructions for the authors of the technology chapters. The general assumptions are described in section 1.1. The following sections (1.2 and 1.3) explain the formats of the technology chapters, how data were obtained, and which assumptions they are based on. Each technology is subsequently described in a separate technology chapter, making up the main part of this catalogue. The technology chapters contain both a description of the technologies and a quantitative part including a table with the most important technology data.

General assumptions

The data presented in this catalogue is based on some general assumptions, mainly with regards to the utilization and start-ups of plants and technologies.

On the one hand, plants for biofuel production and production/upgrade of biogas and syngas are assumed to be designed and operated on a continuous basis along the year, except for maintenance and outages. Therefore, they feature a high number of full load hours (around 8000 h/y) and a reduced number of start-ups (5 per year).

On the other hand, electrolyzers are assumed to be designed and operated for approximately 4000 full load hours annually. In particular, use the advantage of lower power prices by producing e.g. in hours of high renewable energy production (similarly to heat pumps). The assumed number of start-ups and consequent shut-downs for electrolyzers, unless otherwise stated, is 50 per year.

Any exception to these general assumptions is documented in the relative technology chapter with a specific note.

Qualitative description

The qualitative part describes the key characteristics of the technology as concise as possible. The following paragraphs are included where relevant for the technology.

Contact information

Containing the following information:

- Contact information: Contact details in case the reader has clarifying questions to the technology chapters. This could be the Danish Energy Agency, Energinet.dk or the author of the technology chapters.
- Author: Entity/person responsible for preparing the technology chapters
- Reviewer: Entity/person responsible for reviewing the technology chapters.

Brief technology description

Brief description for non-engineers of how the technology works and for which purpose.

An illustration of the technology is included, showing the main components and working principles.

Input

The main raw materials and other forms of energy consumed (e.g. electricity, heat) by the technology or facility. Moisture content of the fuel and required temperature of the input heat is specified.

Auxiliary inputs, such as enzymes or chemicals assisting the process are mentioned and their contribution described, if considered relevant.

Output

The output energy carrier as well as co-product or by-products, for example process heat. Temperature of the output heat is specified as well. Non-energy outputs may be stated as well, if relevant.

Energy balance

The energy balance shows the energy inputs and outputs for the technology. Here an illustrative diagram is shown based on data for the year 2015, thus currently available technology.

For process heat losses and produced energy carrier, it is important to specify information about temperature and pressure.

The first important assumption is that the energy content of all the fuels, both produced and consumed, is always expressed in terms of Lower Heating Value (LHV). As a consequence, because of the presence of some latent heat of vaporisation, the energy balance may result in a difference between total energy input and total energy output.

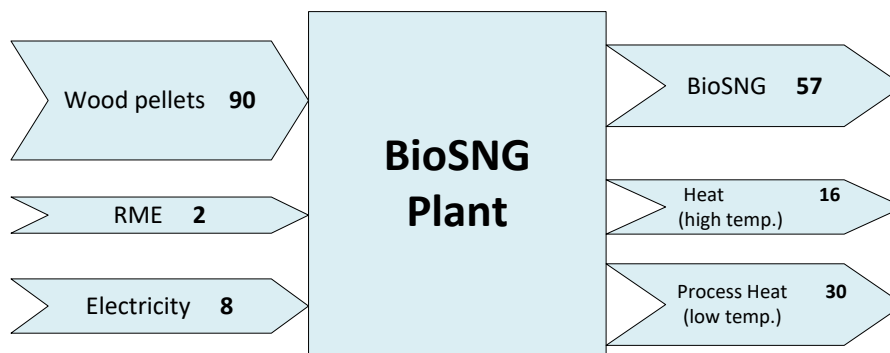

Figure 1 Example of Energy balance. All inputs sum up to 100 units.

For comparison, 100 units of total input are used to standardize the diagrams. This choice allows the reader to easily calculate the efficiency for each of the output, which will be directly equal to the energy value in the balance.

Each of the inputs and outputs has to be accounted for in the diagram, including auxiliary electricity consumption in input and process heat losses in output

Auxiliary products, as for example chemicals and enzymes, will in general only assist the process and are then not relevant for the energy balance. They should just be included as *auxiliary product input data*.

Typical capacities

The capacity, preferably a typical capacity (not maximum capacity), is stated for a single plant or generation facility. In case different sizes of plant are common, multiple technologies can be presented, e.g. Large, Medium and Small.

Regulation ability

Mainly relevant for hydrogen technologies where electricity is used as main input. Description of the part-load characteristics, how fast can they start up and how fast are they able to respond to supply changes and does part-load or fast regulation lead to increased (or lower) wear and hence increased cost.

Space requirement

Space requirement is specified in 1,000 m² per MW of thermal (*Typical plant capacity*). The space requirements may for example be used to calculate the rent of land, which is not included in the financial cost, since this cost item depends on the specific location of the plant.

Advantages/disadvantages

A description of specific advantages and disadvantages relative to equivalent technologies. Generic advantages are ignored; e.g. renewable energy technologies mitigating climate risks and enhance security of supply.

Environment

Particular environmental and resource depletion impacts are mentioned, for example harmful emissions to air, soil or water; consumption of rare or toxic materials; issues with handling of waste and decommissioning etc.

The energy payback time or energy self-depreciation time may also be mentioned. This is the time required by the technology for the production of energy equal to the amount of energy that was consumed during the production of the technology.

Research and development perspectives

This section lists the most important challenges to further development of the technology. Also, the potential for technological development in terms of costs and efficiency is mentioned and quantified. Danish research and development perspectives are highlighted, where relevant.

Examples of market standard technology

Recent full-scale commercial projects, which can be considered market standard, are mentioned, preferably with links. A description of what is meant by “market standard” is given in the introduction to the quantitative description section (Section 1.3). For technologies where no market standard has yet been established, reference is made to best available technology in R&D projects.

Prediction of performance and costs

Cost reductions and improvements of performance can be expected for most technologies in the future. This section accounts for the assumptions underlying the cost and performance in 2015 as well as the improvements assumed for the years 2020, 2030 and 2050.

The specific technology is identified and classified in one of four categories of technological maturity, indicating the commercial and technological progress, and the assumptions for the projections are described in detail.

In formulating the section, the following background information is considered:

Data for 2015

In case of technologies where market standards have been established, performance and cost data of recent installed versions of the technology in Denmark or the most similar countries in relation to the specific technology in Northern Europe are used for the 2015 estimates.

If consistent data are not available, or if no suitable market standard has yet emerged for new technologies, the 2015 costs may be estimated using an engineering based approach applying a decomposition of manufacturing and installation costs into raw materials, labor costs, financial costs, etc. International references such as the IEA, NREL etc. are preferred for such estimates.

Assumptions for the period 2020 to 2050

According to the IEA:

“Innovation theory describes technological innovation through two approaches: the technology-push model, in which new technologies evolve and push themselves into the marketplace; and the market-pull model, in which a market opportunity leads to investment in R&D and, eventually, to an innovation” (ref. 6).

The level of “market-pull” is to a high degree dependent on the global climate and energy policies. Hence, in a future with strong climate policies, demand for e.g. renewable energy technologies will be higher, whereby innovation is expected to take place faster than in a situation with less ambitious policies. This is expected to lead to both more efficient technologies, as well as cost reductions due to economy of scale effects. Therefore, for technologies where large cost reductions are expected, it is important to account for assumptions about global future demand.

The IEA’s New Policies Scenario provides the framework for the Danish Energy Agency’s projection of international fuel prices and CO₂-prices, and is also used in the preparation of this catalogue. Thus, the projections of the demand for technologies are defined in accordance with the thinking in the New Policies Scenario, described as follows:

“New Policies Scenario: A scenario in the World Energy Outlook that takes account of broad policy commitments and plans that have been announced by countries, including national pledges to reduce greenhouse gas emissions and plans to phase out fossil energy subsidies, even if the measures to implement these commitments have yet to be identified or announced. This broadly serves as the IEA baseline scenario.” (ref. 7).

Alternative projections may be presented as well relying for example on the IEA’s 450 Scenario (strong climate policies) or the IEA’s Current Policies Scenario (weaker climate policies).

Learning curves and technological maturity

Predicting the future costs of technologies may be done by applying a cost decomposition strategy, as mentioned above, decomposing the costs of the technology into categories such as labor, materials, etc. for which predictions already exist. Alternatively, the development could be predicted using learning curves. Learning curves express the idea that each time a unit of a particular technology is produced, learning accumulates, which leads to cheaper production of the next unit of that technology. The learning rates also take into account benefits from economy of scale and benefits related to using automated production processes at high production volumes.

The potential for improving technologies is linked to the level of technological maturity. The technologies are categorized within one of the following four levels of technological maturity.

Category 1. Technologies that are still in the *research and development phase*. The uncertainty related to price and performance today and in the future is highly significant (e.g. wave energy converters, solid oxide fuel cells).

Category 2. Technologies in the *pioneer phase*. The technology has been proven to work through demonstration facilities or semi-commercial plants. Due to the limited application, the price and performance is still attached with high uncertainty, since development and customization is still needed. The technology still has a significant development potential (e.g. gasification of biomass).

Category 3. *Commercial technologies with moderate deployment*. The price and performance of the technology today is well known. These technologies are deemed to have a certain development potential and therefore there is a considerable level of uncertainty related to future price and performance (e.g. offshore wind turbines)

Category 4. *Commercial technologies, with large deployment*. The price and performance of the technology today is well known and normally only incremental improvements would be expected. Therefore, the future price and performance may also be projected with a relatively high level of certainty (e.g. coal power, gas turbine).

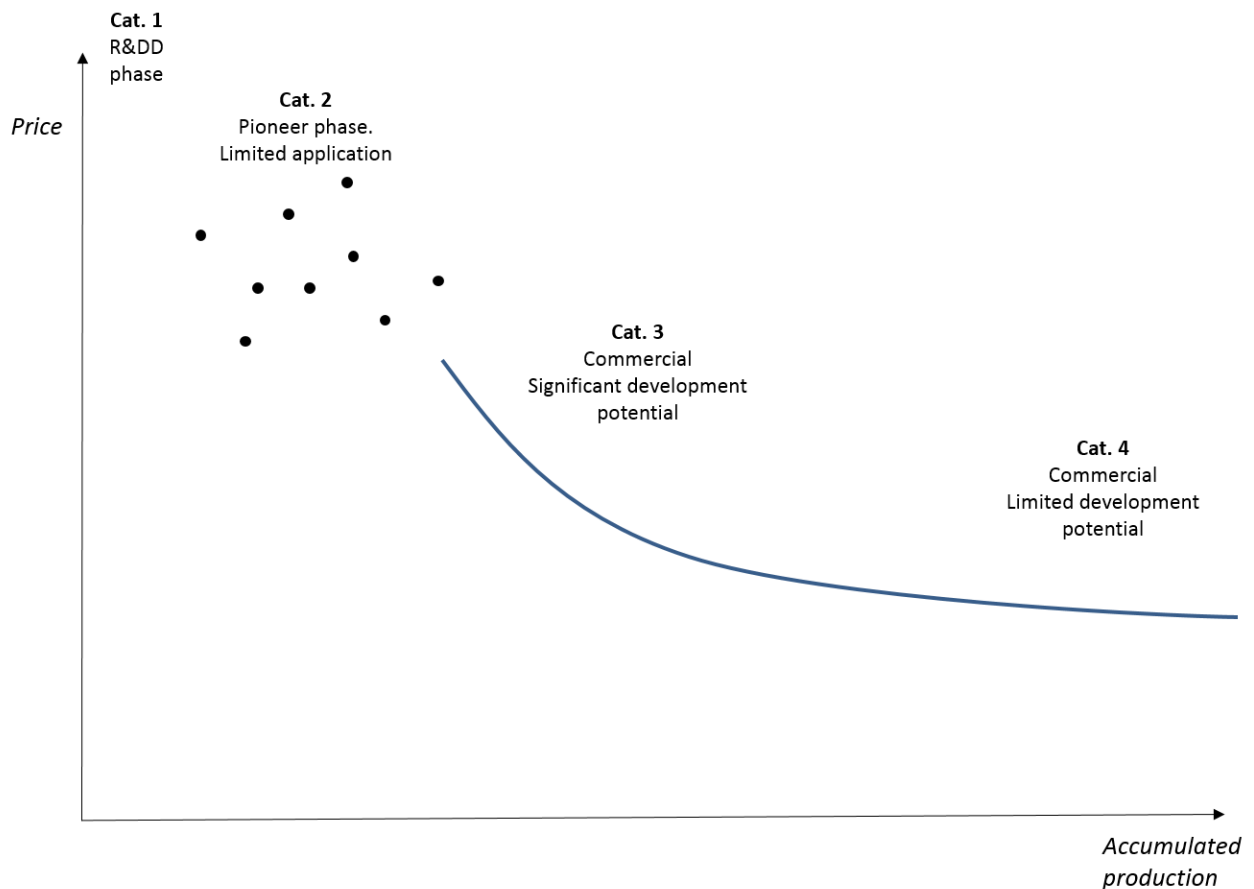

Figure 2: Technological development phases, correlation between accumulated production volume (MW) and price.

Uncertainty

The catalogue covers both mature technologies and technologies under development. This implies that the price and performance of some technologies may be estimated with a relatively high level of certainty whereas in the case of others, both cost and performance today as well as in the future are associated with high levels of uncertainty.

This section of the technology chapters explains the main challenges to precision of the data and identifies the areas on which the uncertainty ranges in the quantitative description are based. This includes technological or market related issues of the specific technology as well as the level of experience and knowledge in the sector and possible limitations on raw materials. The issues should also relate to the technological development maturity as discussed above.

The level of uncertainty is illustrated by providing a lower and higher bound beside the central estimate, which shall be interpreted as representing probabilities corresponding to a 90% confidence interval. It should be noted, that projecting costs of technologies far into the future is a task associated with very large

uncertainties. Thus, depending on the technological maturity expressed and the period considered, the confidence interval may be very large. It is the case, for example, of less developed technologies (category 1 and 2) and longtime horizons (2050).

Additional remarks

This section includes other information, for example links to web sites that describe the technology further or give key figures on it.

References

References are numbered in the text in squared brackets and bibliographical details are listed in this section.

Quantitative description

To enable comparative analyses between different technologies it is imperative that data are actually comparable: All cost data are stated in fixed 2015 prices excluding value added taxes (VAT) and other taxes. The information given in the tables relate to the development status of the technology at the point of final investment decision (FID) in the given year (2015, 2020, 2030 and 2050). FID is assumed to be taken when financing of a project is secured and all permits are at hand. The year of commissioning will depend on the construction time of the individual technologies.

A typical table of quantitative data is shown below, containing all parameters used to describe the specific technologies. The datasheet consists of a generic part, which is identical for all technologies and a technology specific part, containing information, which is only relevant for the specific technology. The generic part is made to allow for easy comparison of technologies.

It has to be noted that, in case a technology has more than one input or output, rows will be added to the datasheet.

Each cell in the table contains only one number, which is the central estimate for the market standard technology, i.e. no range indications.

Uncertainties related to the figures are stated in the columns named *uncertainty*. To keep the table simple, the level of uncertainty is only specified for years 2020 and 2050.

The level of uncertainty is illustrated by providing a lower and higher bound. These are chosen to reflect the uncertainties of the best projections by the authors. The section on uncertainty in the qualitative description for each technology indicates the main issues influencing the uncertainty related to the specific technology. For technologies in the early stages of technological development or technologies especially prone to variations of cost and performance data, the bounds expressing the confidence interval could result in large intervals. The uncertainty only applies to the market standard technology. The uncertainty interval does not represent the product range (for example a product with lower efficiency at a lower price or vice versa).

The level of uncertainty is stated for the most critical figures such as investment cost and specific output shares. Other figures are considered if relevant.

All data in the tables are referenced by a number in the utmost right column (Ref), referring to source specifics below the table. The following separators are used:

; (semicolon)	separation between the four time horizons (2015, 2020, 2030, and 2050)
/ (forward slash)	separation between sources with different data
+ (plus)	agreement between sources on same data

Notes include additional information on how the data are obtained, as well as assumptions and potential calculations behind the figures presented. Before using the data, please be aware that essential information may be found in the notes below the table.

The generic parts of the datasheets for energy carrier generation and conversion technologies are presented below:

Technology	name/ description									
	2015	2020	2030	2050	Uncertainty (2020)		Uncertainty (2050)		Note	Ref
Energy/technical data					Lower	Upper	Lower	Upper		
Typical total plant size (MW output)										
- Inputs										
A) Energy input share (% total input(MWh/MWh))										
B) Energy input share (% total input(MWh/MWh))										
C) Energy input share (% total input(MWh/MWh))										
X) Auxiliary products inputs (kg/MWh)										
Y) Auxiliary products inputs (kg/MWh)										
- Outputs										
A) Output share (% total input (MWh/MWh))										
B) Output share (% total input (MWh/MWh))										
C) Output share (% total input (MWh/MWh))										
X) Non-energy outputs (kg/MWh)										
Y) Non-energy outputs (kg/MWh)										
Forced outage (%)										
Planned outage (weeks per year)										
Technical lifetime (years)										
Construction time (years)										

Financial data										
Specific investment (€ /MW of total input)										
- hereof equipment (%)										
- hereof installation (%)										
Fixed O&M (€ /MW of total input)										
Variable O&M (€/MWh of total input)										
Startup cost (€ /MW of total input per startup)										
Technology specific data										

Energy/technical data

Typical total plant size

The total thermal capacity, preferably a typical capacity, is stated for a single plant or facility. It represents the sum of all input and is expressed in MW thermal.

Input

All inputs that contribute to the energy balance are included as *main energy input* and are expressed as percentage in relation to the total energy input, or equivalently as MWh/MWh of total input.

The energy inputs (and outputs) are always expressed in lower heating value (LHV) and moisture content considered is specified if relevant.

Auxiliary inputs, such as **enzymes** or **chemicals** that are assisting the process but do not contribute to the energy balance are included as *auxiliary products* (under *input*) and are expressed in kg/MWh of total energy input.

Output

Similarly to the energy inputs, energy outputs are expressed as percentage value in relation to the total energy input, or equivalently as MWh/MWh of total input.

Any energy co-product or by-product of the reaction has to be specified within the outputs, including process heat loss. Since fuel inputs are measured at lower heating value, in some cases the total efficiency may exceed or be lower than 100%.

The output shares represent the partial efficiencies in producing the different outputs.

The process heat (output) is, if possible, separated in recoverable (for example for district heating purposes) and unrecoverable heat and the temperatures are specified.

Forced and planned outage

Forced outage is defined as the number of weighted forced outage hours divided by the sum of forced outage hours and operation hours. The weighted forced outage hours are the sum of hours of reduced production caused by unplanned outages, weighted according to how much capacity was out.

Forced outage is given in percent, while planned outage (for example due to renovations) is given in days per year.

Technical lifetime

The technical lifetime is the expected time for which an energy plant can be operated within, or acceptably close to, its original performance specifications, provided that normal operation and maintenance takes place. During this lifetime, some performance parameters may degrade gradually but still stay within acceptable limits. For instance, power plant efficiencies often decrease slightly (few percent) over the years, and O&M costs increase due to wear and degradation of components and systems. At the end of the technical lifetime, the frequency of unforeseen operational problems and risk of breakdowns is expected to lead to unacceptably low availability and/or high O&M costs. At this time, the plant is decommissioned or undergoes a lifetime extension, which implies a major renovation of components and systems as required making the plant suitable for a new period of continued operation.

The technical lifetime stated in this catalogue is a theoretical value inherent to each technology, based on experience. As explained in the *General Assumptions*, different types of plants are designed for a different annual utilization and typical number of start-ups a year. The expected technical lifetime takes into account these assumptions.

In real life, specific plants of similar technology may operate for shorter or longer times. The strategy for operation and maintenance, e.g. the number of operation hours, start-ups, and the reinvestments made over the years, will largely influence the actual lifetime.

Construction time

Time from final investment decision (FID) until commissioning completed (start of commercial operation), expressed in years.

Financial data

Financial data are all in Euro (€), fixed prices, at the 2015-level and exclude value added taxes (VAT) and other taxes.

Several data originate in Danish references. For those data a fixed exchange ratio of 7.45 DKK per € has been used.

The previous catalogue was in 2011 prices. Some data have been updated by applying the general inflation rate in Denmark (2011 prices have been multiplied by 1.0585 to reach the 2015 price level).

European data, with a particular focus on Danish sources, have been emphasized in developing this catalogue. This is done as generalizations of costs of energy technologies have been found to be impossible above the regional or local levels, as per IEA reporting from 2015 (ref. 3). For renewable energy technologies this effect is even stronger as the costs are widely determined by local conditions.

Investment costs

The investment cost is also called the engineering, procurement and construction (EPC) price or the overnight cost. Infrastructure and connection costs, i.e. electricity, fuel and water connections inside the premises of a plant, are also included.

The investment cost is reported on a normalized basis, i.e. cost per MW. The specific investment cost is the total investment cost divided by the *Typical total plant size* described in the quantitative section.

Where possible, the investment cost is divided on equipment cost and installation cost. Equipment cost covers the components and machinery including environmental facilities, whereas installation cost covers engineering, civil works, buildings, grid connection, installation and commissioning of equipment.

The rent of land is not included but may be assessed based on the space requirements, if specified in the qualitative description.

The owners' predevelopment costs (administration, consultancy, project management, site preparation, approvals by authorities) and interest during construction are not included. The costs to dismantle decommissioned plants are also not included. Decommissioning costs may be offset by the residual value of the assets.

Cost of grid expansion

The costs for the connection of the plant to the system are included in the investment cost, while no cost of grid expansion or reinforcement is taken into account in the present data.

Economy of scale

The main idea of the catalogue is to provide technical and economic figures for particular sizes of plants. Where plant sizes vary in a large range, different sizes are defined and separate technology chapters are developed.

For assessment of data for plant sizes not included in the catalogue, some general rules should be applied with caution to the scaling of plants.

The cost of one unit for larger power plants is usually less than that for smaller plants. This is called the 'economy of scale'. The basic equation (ref. 2) is:

$$\frac{C_1}{C_2} = \left(\frac{P_1}{P_2}\right)^a$$

Where: C_1 = Investment cost of plant 1 (e.g. in million EUR)
 C_2 = Investment cost of plant 2
 P_1 = Power generation capacity of plant 1 (e.g. in MW)
 P_2 = Power generation capacity of plant 2
 a = Proportionality factor

Usually, the proportionality factor is about 0.6 – 0.7, but extended project schedules may cause the factor to increase. It is important, however, that the plants are essentially identical in construction technique, design, and construction time frame and that the only significant difference is in size.

For technologies that have a more modular structure, such as electrolysers, the proportionality factor is equal to 1.

The relevant ranges where the economy of scale correction applies are stated in the notes for the capacity field of each technology table. The stated range represents typical capacity ranges.

Operation and maintenance (O&M) costs

The fixed share of O&M is calculated as cost per plant size (€ per MW per year), where the typical total plant size is the one defined at the beginning of this chapter and stated in the tables. It includes all costs, which are independent of how the plant is operated, e.g. administration, operational staff, payments for O&M service agreements, network use of system charges, property tax, and insurance. Any necessary reinvestments to keep the plant operating within the scheduled lifetime are also included, whereas reinvestments to extend the life beyond the lifetime are excluded. Reinvestments are discounted at 4 % annual discount rate in real terms. The cost of reinvestments to extend the lifetime of the plants may be mentioned in a note if the data has been readily available.

The variable O&M costs (€/MWh) include consumption of auxiliary materials (water, lubricants, fuel additives), treatment and disposal of residuals, spare parts and output related repair and maintenance (however not costs covered by guarantees and insurances).

Planned and unplanned maintenance costs may fall under fixed costs (e.g. scheduled yearly maintenance works) or variable costs (e.g. works depending on actual operating time), and are split accordingly.

All costs related to the process inputs (electricity, heat, fuel) are not included.

It should be noticed that O&M costs often develop over time. The stated O&M costs are therefore average costs during the entire lifetime.

Start-up costs

The O&M costs stated in this catalogue includes start-up costs and takes into account a typical number of start-ups and shut-downs. Therefore, the start-up costs should not be specifically included in more general analyses. They should only be used in detailed dynamic analyses of the hour-by-hour load of the technology.

Start-up costs, are stated in costs per MW of typical plant size (€/MW/startup), if relevant. They reflect the direct and indirect costs during a start-up and the subsequent shut down.

The direct start-up costs include fuel consumption, e.g. fuel which is required for heating up boilers and which does not yield usable energy, electricity consumption, and variable O&M costs corresponding to full load during the start-up period.

The indirect costs include the theoretical value loss corresponding to the lifetime reduction for one start up. For instance, during the heating-up, thermal and pressure variations will cause fatigue damage to components, and corrosion may increase in some areas due to e.g. condensation.

An assumption regarding the typical amount of start-ups is made for each technology in order to calculate the O&M costs. As a general assumption, biofuel production and production/upgrade of biogas features 5 start-ups per year, while for electrolyzes 50 start-ups a years are assumed. Any change with respect to this general assumption, e.g. for a specific technology which is characterized by a different utilization, is specified in the notes.

The stated O&M costs may be corrected to represent a different number of start-ups than the one assumed by using the stated start-up costs with the following formula:

$$O\&M_{new} = O\&M_{old} - (Startup\ cost * n_{startup}^{old}) + (Startup\ cost * n_{startup}^{new})$$

where $n_{startup}^{old}$ is the number of start-ups specified in the notes for the specific technology and $n_{startup}^{new}$ is the desired number of start-ups.

Technology specific data

Additional data is specified in this section, depending on the technology.

For example, **operating temperatures** are indicated for electrolysis and other processes in which it is a relevant parameter.

Whenever process heat is available as output, its **temperature** is specified as well.

For electrolysis technologies, parameters regarding the **regulation ability** are specified as follow:

- Ramp up time, linear to full load (minutes)
- Ramp down time, linear from full load (minutes)

- Start-up time (minutes)
- Minimum load (%)

Relevant **emissions to the environment**, including emissions to water and air, are reported in g per MWh of total input of fuel at the lower heating value.

All plants are assumed to be designed to comply with the environmental regulation that is currently in place in Denmark and planned to be implemented within the 2020 time horizon.

Definitions

The **latent heat of vaporization** is the heat absorbed when a substance changes phase from liquid to gas.

The **lower heating value** (also known as net calorific value) of a fuel is defined as the amount of heat released by combusting a specified quantity (initially at 25°C) and returning the temperature of the combustion products to 150°C, which assumes the latent heat of vaporization of water in the reaction products is not recovered. The LHV are the useful calorific values in boiler combustion plants and are frequently used in Europe.

Using the LHV for efficiency definition, a condensing boiler can achieve a thermal efficiency of more than 100%, because the process recovers part of the heat of vaporization.

The **higher heating value** (also known as gross calorific value or gross energy) of a fuel is defined as the amount of heat released by a specified quantity (initially at 25°C) once it is combusted and the products have returned to a temperature of 25°C, which takes into account the latent heat of vaporization of water in the combustion products.

When using HHV for thermal efficiency definition, the thermodynamic limit of 100% cannot be exceeded.

Overview of technologies for renewable fuel production

A short overview of the technologies and pathways for renewable fuel production, that are included in the catalogue, is presented in the following. The aim is to ease the use of the catalogue. The pathways have been divided into four overall categories, each of which is depicted in the following figures and tables. The tables elaborate the pathways in slightly more detail than the figures.

The four overall categories are as follows.

1. Biomass to gaseous products and synthetic natural gas (Figure 1 and Table 1)
2. Electricity to hydrogen (Figure 2 and Table 2)
3. Oils and fats to liquid fuels
4. Biomass and CO₂ + electricity to liquid fuels

The categories are divided in respect to the inputs and outputs. The relevant chapter reference number is given for each output in figures and tables.

Short descriptions of selected terms are included in this section. For more information about the pathways please refer to the respective chapters.

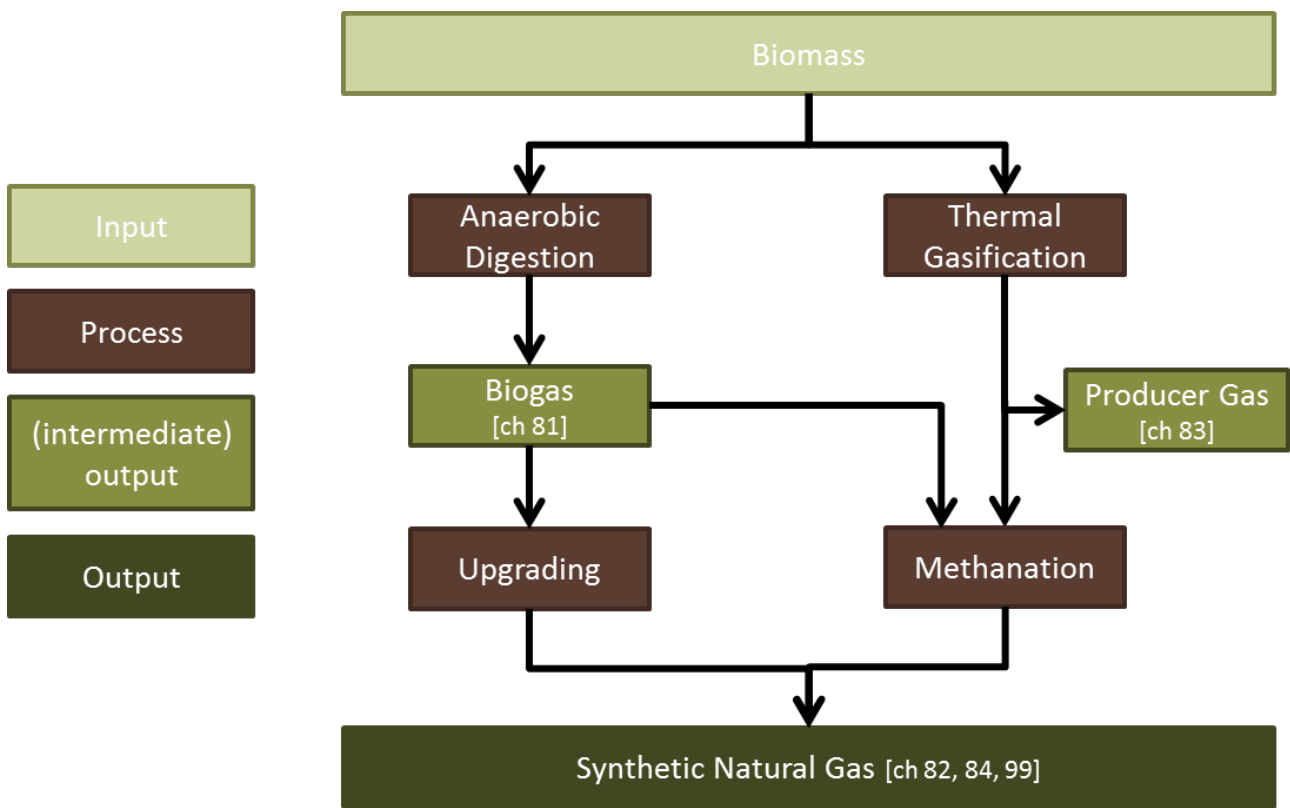

Figure 1 Pathways for biomass to gaseous products and synthetic natural gas

	Biogas Plants	Biogas Upgrading	Biomass Gasification	Biomass Gasification	SNG from Methanation of Biogas
Inputs	Organic waste	Raw biogas	Solid Biomass	Solid biomass	Biogas
	Ag. res.		Wood chips	Wood chips	Hydrogen/Water
	Energy Crops		Energy Crops	Ag. waste	Electricity
Method	Anaerobic digestion	Upgrading	Thermal gasification	Thermal gasification	Methanation
			Fixed bed	Cleaning	
Outputs	Biogas	Biomethane	Producer gas	Bio-SNG	Bio-SNG
	Digestate				
Chapter	81	82	83	84	99

Table 1 Biomass to gaseous products and synthetic natural gas.
 1: Agricultural residues, 2: agricultural waste.

- Biogas – A mixture of methane and carbon dioxide.
- Producer gas – A mixture of hydrogen, carbon monoxide, carbon dioxide, methane, and C2 to C4 hydrocarbons.
- SNG – Synthetic Natural Gas. Chemically the same as Bio-methane.
- Digestate – Material remaining after anaerobic digestion, usually high in nutrients.
- Ag res – agricultural residues
- Ag waste – agricultural waste

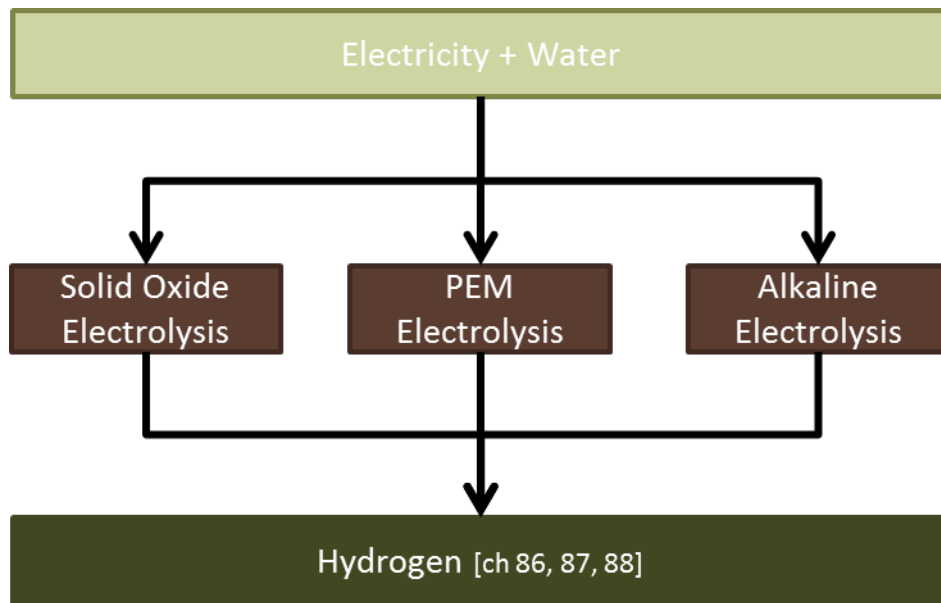

Figure 2 Pathways for hydrogen production from electricity (PEM: Polymer electrolyte membrane or Proton exchange membrane)

	Solid Oxide Electrolyzer Cell	Low Temp PEM Electrolyzer Cell	Alkaline Electrolyser Cell
Inputs	Water	Water	Water
	Electricity	Electricity	Electricity
	Heat		
Method	High temperature electrolysis	PEM electrolysis	Electrolysis
Outputs	Hydrogen	Hydrogen	Hydrogen
	Oxygen	Oxygen	Oxygen
		Heat	Heat
Chapter	86	87	88

Table 2 Electricity to hydrogen (PEM: Polymer electrolyte membrane or Proton exchange membrane)

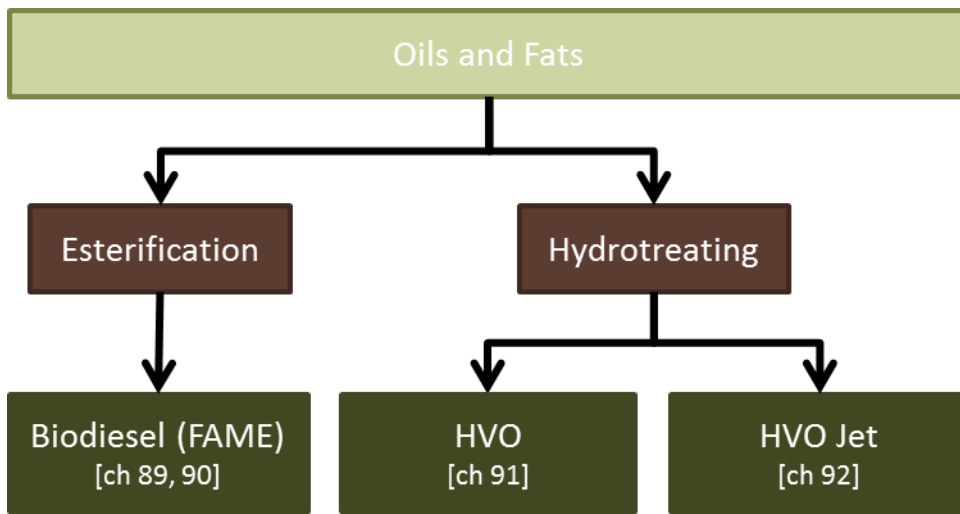

Figure 3 Pathways for oils and fats to liquid fuels

	Vegetable Oil FAME	UCO and Animal fat FAME	Hydrogenated Vegetable Oil	HVO Jet Fuel
Inputs	Vegetable Oil	UCO	Vegetable Oil	Vegetable Oil
		Animal Fats	Hydrogen	
Method	Esterification	Acid catalyzed esterification	Hydrogenation	Hydrogenation
			Isomerization	Isomerization/ Hydrocracking
Outputs	Biodiesel	Biodiesel	HVO	HVO Jet
	Glycerine	Glycerine		
Chapter	89	90	91	92

Table 3 Oils and fats to liquid fuels

- Esterification - Biodiesel reaction.
- Biodiesel (FAME) – Fatty acid methyl ester. Fuel contains oxygen.
- HVO –Hydrogenated Vegetable Oil, also known as renewable diesel. Fuel is oxygen free.
- Hydrotreating covers both deoxygenation and decarboxylation reactions.
- UCO – Used cooking oil.

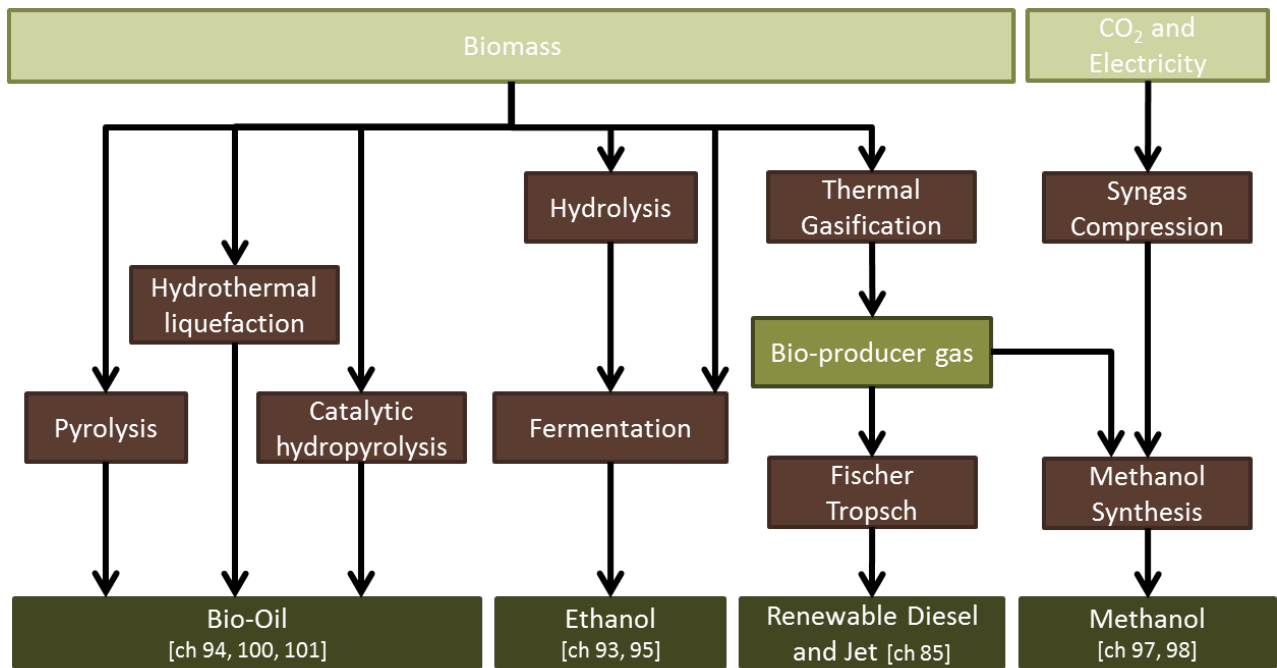

Figure 4 Pathways for biomass to liquid fuels and CO₂ + electricity to liquid fuels

	Biomass Gasification	1st Gen Ethanol	Pyrolysis Oils	Cellulosic Ethanol	Methanol from Biomass Gasification	Methanol from Power	Hydrothermal Liquefaction	Catalytic Hydroxypropylation
Inputs	Solid biomass	Corn	Dry Biomass	Cellulosic feedstock	Biomass	Water/ Hydrogen	Biomass	Biomass
		Wheat Grains				CO ₂ Electricity	Hydrogen	Hydrogen
Method	Thermal gasification	Fermentation	Pyrolysis	Hydrolysis	Gasification	Syngas Compression	Thermo-chemical conversion	Thermochemical conversion
	Fischer Tropsch		Methanol Synthesis + Distillation	Fermentation	Methanol Synthesis	Methanol Synthesis + Distillation		
Outputs	Renewable Diesel	Ethanol	Bio-oil	Ethanol	Methanol	Methanol	Bio-oil	Bio-oil
	Renewable Jet fuel		DDG	Char	Heat			
	Renewable Naphtha							
Chapter	85	93	94	95	97	98	100	101

Table 4 Biomass to liquid fuels and CO₂ + electricity to liquid fuels

- Renewable Diesel from Fischer Tropsch is chemical similar to HVO.
- Renewable Naphtha – a mixture of various hydro carbons with a boiling point range between 30 °C and 220 °C which can be used for gasoline production.
- Syngas – A mixture of hydrogen, carbon monoxide and carbon dioxide.
- DDG – Distillers’ dried grains, a high protein animal feed.
- Bio-oil – A mixture of organic chemicals contains varying amounts of oxygen. Bio-oil can be refined to various fuels, such as gasoline, diesel and jet.

References

Numerous reference documents are mentioned in each of the technology sheets. Other references used in the Guideline are mentioned below:

- [1] Danish Energy Agency: "Forudsætninger for samfundsøkonomiske analyser på energiområdet" (Generic data to be used for socio-economic analyses in the energy sector), May 2009.
- [2] "Economy of Scale in Power Plants", August 1977 issue of Power Engineering Magazine
- [3] "Projected Costs of Generating Electricity", International Energy Agency, 2015.
- [4] "Konvergensprogram Danmark 2015". Social- og Indenrigsministeriet. March 2015.
- [5] "Technology Data for Hydrogen Technologies".
- [6] "Technology data for advanced bioenergy fuels", Energistyrelsen
- [7] "Hydrogen Analysis Resource center website", US DoE. Url: <http://hydrogen.pnl.gov/tools/lower-and-higher-heating-values-fuels>
- [8] "Energy Technology Perspectives", International Energy Agency, 2012.
- [9] International Energy Agency. Available at: <http://www.iea.org/>. Accessed: 11/03/2016.

81 Biogas Plants

Contact information:

Danish Energy Agency: Jacob Hjerrild Zeuthen and Filip Gamborg

Author: EA Energianalyse

Publication date

June 2017

Amendments after publication date

Date	Ref.	Description
-	-	-
-	-	-

Qualitative description

Brief technology description

Biogas plants produce a methane rich gas on the basis of biodegradable organic material. The feedstock is transported to the plant by road or pumped in pipelines. At the plant, it undergoes an anaerobic process, which generates biogas.

The technology data sheet covers larger plants. It does not include biogas from wastewater treatment plants and landfill sites.

The residual biological material can be recycled as a fertilizer in agriculture and may be separated into solids and fluids.

The biogas can be used directly in a natural gas engine for local CHP generation, in a local gas boiler or it can be upgraded to bio SNG (synthetic natural gas). Upgrading of biogas to bio SNG is treated in a separate chapter of the technology catalogue.

The biomass is received and stored in pre-storage tanks and later processed in digestion reactor tanks. The digesters are normally heated to either 35 - 40 °C (mesophilic digestion), or 50 - 55 °C (thermophilic digestion). After being processed in the main reactor, the material is stored in post-processing tanks where further gas is produced and collected. Typical processing time in the digesters is less than 25 days in Danish plants, but many plants have longer retention time in order to increase the gas yield.

Danish plants use continuous digestion in fully stirred digesters. This implies removing a quantity of digested biomass from the digesters and replacing it with a corresponding quantity of fresh biomass, typically several times a day.

Finally, the gas is treated to reduce water and sulphur contents to the desired concentrations.

The figure below shows the typical components and flow in a biogas plant.

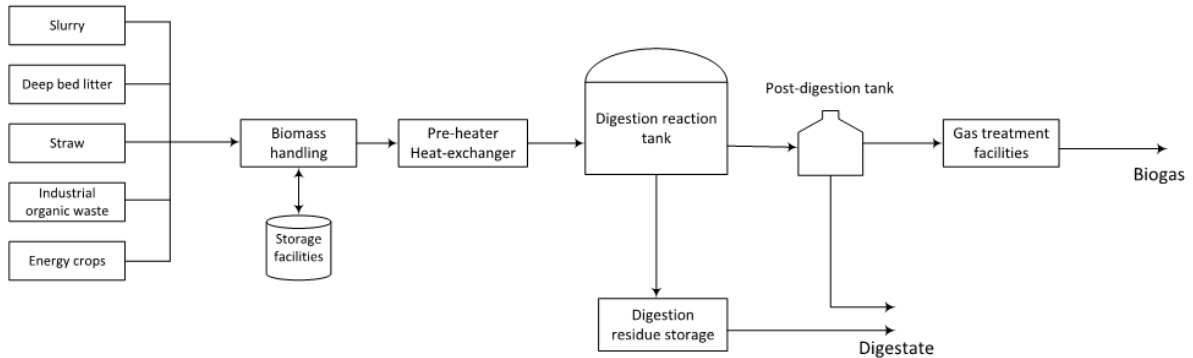

Figure 1: Typical components in a biogas plant.

Input

- Biodegradable organic material such as animal manure/slurry, organic waste from food processing and households, agricultural residues (e.g. straw), energy crops, etc.
- Electricity for mechanical processing equipment.
- Process heat for preheating and heating the reactor tanks.

Output

- Biogas.
- Digestate, e.g. for use as fertilizer.

The biogas gas typically contains 50-75% methane (CH₄), 25-45% carbon dioxide (CO₂) plus a minor content of hydrogen (H₂), nitrogen (N₂), oxygen (O₂), hydrogen sulphide (H₂S) and ammonia (NH₃). The composition of the biogas varies with the specific mix of the input.

Energy balance

It is not practical nor usual to measure the energy content of the input material as a calorific value, as for other energy conversion technologies. Instead the input unit 'Tons per year' and the corresponding output capacity is used to define the size of the plant. Accordingly, the efficiency of the plant is not calculated in the same way as for other conversion technologies, except for straw where the lower calorific energy of the straw input is used.

The volatile solid (VS) content of the biomass represents the fraction of the solid material that may be transformed into biogas. For animal slurry the VS share is approx. 75 %, for source separated household waste it is approx. 80 % and for maize and grasses around 90 %. The methane production achieved in practice

depends on processing time and the organic loading rate among other factors. For further information on the methane output from different types of biomass, see reference [14].

The digestate contains the nutrients and the long term stable carbon of the input material and has a high value as agricultural fertilizer. Drained fractions of the non-digested residual material might be useful for combustion or thermal gasification.

The production of biogas, as well as the content of methane in the biogas, vary with the amount and quality of the organic waste used. Methane has a lower heating value of 35.9 MJ/Nm³. Biogas with 65% methane thus has a heating value of 23.3 MJ/Nm³. To allow comparisons it is practical to measure the output in Nm³ methane.

The data sheets in this chapter comprise a basic plant with input of a proportional mix of resources assessed available in Denmark in year 2012 and 2020 [9]¹, but excluding energy crops and straw.

This plant may represent an “average” or “model plant”. An example of energy properties for a basic plant is shown in table 1.

Basic biogas plant (2015)	Input share (by tons)	Methane production (GJ/ton)*	Methane production (% of total)
Pig and cattle slurry	79.8%	0.44	44%
Deep litter	8.0%	2.00	20%
Manure, stable	6.1%	1.57	12%
Straw	0.0%	7.27	0%
Industrial organic waste	1.0%	4.83	6%
Household waste	1.6%	3.41	7%
Energy crops	0.0%	1.5 - 3.5	0%
Other	3.5%	1 - 5	11%
Total	100%	0.80	100%

Table 1: Energy properties for basic biogas plant with a mix of input material, 2015. *Based on references [8] and [9].

As seen in table 1 the potential energy (methane) production per ton of straw and industrial waste is app.10-17 times higher than the potential energy (methane) production per ton of animal slurry. This means that, the methane output of a plant with a certain input capacity (measured in tons) can be increased by increasing the share of feedstock with relative high energy production potential. The differences in methane output is mainly due to varying water content of the different resources.

The possibilities for increasing the share of straw and deep litter material depend on the design of the plant and the pre-treatment of the feedstocks. Experimental work indicates that relatively high shares of straw

¹ Interpolations are made for year 2015

may be possible [5]. The possibility of pumping the biomass puts an upper limit on the amount of it is assumed that the total amount of straw and deep litter material can contribute with up to 50% of the total methane production [9].

A plant with maximum input share of straw and deep litter material could have a mix of input material and corresponding output as shown in table 2.

Increased straw share (2015)	Input share (by tons)	Methane production (GJ/ton)	Methane production (% of total)
Slurry (pig and cattle)	73.5%	0.44	26%
Deep litter	8.0%	2.00	13%
Manure,	6.1%	1.57	8%
Straw	6.3%	7.27	37%
Industrial organic waste	1.0%	4.83	4%
Household waste	1.6%	3.41	4%
Energy crops	0.0%	1,5 - 3,5	0%
Other	3.5%	1 - 5	7%
Total	100%	1.20	100%

Table 2: Input mix and expected output for a basic plant where input of straw and deep litter material contribute to 50 % of output.

Similarly, the energy output from the plant can be increased by a higher share of industrial organic waste, which typically originates from slaughterhouses and other food industries. Table 3 shows the expected methane gas production of the basic plant with a 5% share of industrial organic waste.

Increased industrial organic waste share (2015)	Input percentage (by tons)	Methane production (GJ/ton)	Methane production (% of total)
Slurry (pig and cattle)	75.8%	0.44	34%
Deep litter	8.0%	2.00	16%
Manure,	6.1%	1.57	10%
Straw	0.0%	7.27	0%
Industrial organic waste	5.0%	4.83	25%
Household waste	1.6%	3.41	6%
Energy crops	0.0%	1,5 - 3,5	0%
Other	3.5%	1 - 2	9%
Total	100%	0.97	100%

Table 3: Input and expected methane gas production from the basic plant but with 5 % industrial organic waste

While feedstocks with higher dry matter content may yield higher methane content in the biogas they also set additional requirements to transport and pre-processing systems and may increase the auxiliary energy consumption. Feedstocks such as straw and energy crops with higher contents of lignocellulose must be

mechanically chopped, ground, or otherwise treated before being fed into the digester in order to obtain an acceptable processing time [5]. Thus, higher yields when using alternative feedstocks are usually followed by increased investment and O&M costs. Also, the purchase of high yield feedstocks will increase the production costs.

Typical capacities

In 2015, there were about 25 centralised biogas plants in operation in Denmark, and a larger number of smaller plants (app. 50 farm scale biogas plants and app. 50 anaerobic digesters at waste water treatment plants and a few plants for treating waste water from industries). A centralised biogas plant in Denmark typically has an input capacity from 70.000 to 700.000 tonnes per year [5], and raw material is, typically delivered from 10 to 100 farms. In a study based on data from 16 existing Danish plants [5] an average yield of approximately 28 Nm³ methane per tons input was reported, corresponding to around 1 GJ/ton, however with large variations from approx. 17 to 52 Nm³ methane/ton. The trend is towards larger plants, driven by cost reductions related to economy-of-scale effects for the biogas plant and in particular the upgrading facilities.

Regulation ability

Biogas production in the same reactor can be increased by adding organic materials with high methane potential, however, there is a biological limit to how fast the production can be regulated. For example, a biogas plant digesting only animal slurry during summer, may increase the gas yield from 14-14.5 m³ methane per tonne to about 45-50 m³ methane per tonne during a period of 3 to 4 weeks if biomass with a higher methane production potential is added [3].

Regulation of the production may require additional feedstock storage capacity, e.g. in case of a constant supply of biomass from stables. But the additional income from gas sales may not balance the extra costs of storing feedstock and digested biomass. Also, the emission of greenhouse gasses may increase [3].

A typical smaller plant with CHP production has a gas storage of approximately a half-day's production to accommodate price and demand variations.

Regulation is not relevant for biogas plants with upgrading plants and connection to the central natural gas grid.

Space requirement

The space requirements will vary depending on the design and lay-out. Biogas plants are typically placed in open farm land.

Advantages/disadvantages

Advantages:

- Methane emission is mitigated, with relatively low CO₂ abatement costs [6] fossil fuels are substituted
- Saved expenses in slurry handling and storage.

- Environmentally critical nutrients, primarily nitrogen, phosphorus and potassium, can be redistributed from intense farmlands to other areas. The risk of leaching of nitrates is reduced.
- The fertilizer value of the digested biomass is better than the raw materials. The fertilizer value is also better known, and it is therefore easier to administer the right dose to the crops.
- For waste fractions with a high water content, co-digestion of manure and waste can often provide a low cost option compared to other forms of waste handling, such as incineration.
- Compared to other forms of waste handling such as incineration, biogas digestion of solid biomass has the advantage of recycling nutrients to the farmland – in an economically and environmentally sound way.
- Application of digestate reduces smell compared to application of raw slurry
- Using straw in biogas plants does not deplete the content of carbon in the topsoil compared to using straw for heating (combustion)

Disadvantages:

- Use of straw and other solid biomass resources in biogas production yields a lower energy output than if the same feedstock was used for thermal gasification and/or combustion.
- The successful operation of biogas plants is relatively complex and requires large experience
- The consumption of large quantities of biomass with low dry-matter content (manure) makes transport and sourcing radius a critical parameter.
- Use of heat from biogas fueled decentralized CHP plants is dependent on the heat demand in the local district heating system. A low heat demand can otherwise limit operation during summer season.

Environment

Biogas can substitute fossil fuels in the energy system and thereby avoid emissions of CO₂.

Furthermore, biogas can prevent significant emissions of the greenhouse gas methane to the atmosphere when the biomass is digested in biogas plant, during storage and application on the field. However, an amount of biogas risks to leak from the plants.

In a study of 15 Danish plants, it was assessed that these biogas plants can reduce greenhouse gas emission by 60-180 kg CO₂ equivalent per ton of biomass digested [5]. This assessment includes the substitution of fossil fuels, reduced methane loss due to digestion and collection and a methane leakage from the plants of 2% of the produced biogas. The figures include methane reductions from relatively large amounts of waste (28% of input), which is assumed treated as manure (stored anaerobically and afterwards spread out in the fields). The substitution of fossil fuels varies, depending on the energy system and on how the plants are operated.

The gas leakages shall be reduced as far as possible during the entire process to avoid emissions of the greenhouse gas (methane) and odour problems in the neighbouring environment. An investigation in 2015, covering nine Danish biogas plants showed an average emission as high as 4.2%. Through by a systematic effort to stopping leakages it was, however, possible to reduce emissions to 0.8% b [12]. 2 % is assessed to

be a realistic average level in the future for existing plants. The goal of the biogas industry in Denmark is to reduce total methane leakages to 1 % by 2020, including losses from upgrading facilities-

Odour problems from biogas plants is often reported as a problem, but can be avoided with proper filtering of the off-gasses and good management during operation. The anaerobic treated organic waste product is almost odour-free compared to raw organic waste.

Biogas contains sulphur, which may represent an environmental problem due to emissions of SO₂.

The content of sulphur (H₂S) in the biogas will vary depending on the feedstock material. When animal slurry is the main source, the raw gas typically contains 3.000-10.000 mg/m³ [2]. The sulphur content can be reduced fully or partially by a number of technologies, or a combination of these, including precipitation with iron chloride in the digester tanks, adsorption with activated carbon filters, or by a biological scrubber [2].

Biogas engines tolerate small amounts of sulphur in the gas, which however causes SO₂ emissions to the environment. When the gas is used for upgrading to bio SNG complete sulphur removal may be necessary, but this is normally included in the upgrading plant. The cost of sulphur removal is in the range 0.005 – 0.07 DKK per m³ biogas when the gas is used for engines and 0.03-0.13 DKK per m³ for complete removal, depending on the flow and the H₂S concentration [2].

Research and development

The Danish biogas R&D activities focus on a number of areas to increase energy production and improve the economy of the plants. Among these are the possibilities of reducing storage of animal slurry before digestion, reduction of methane leakage from tanks and processing equipment, biological optimisation, additional processing time, and use of material with higher dry-matter content e.g. deep litter material and straw [5], [6].

Further development activities are related to optimisation of control systems and logistics, for instance transport systems integrated with larger stable systems, and possibilities for higher dry-matter content in the animal slurry [6].

Examples of market standard technology

The current market standard in Denmark is relatively large plants, which supplies upgraded gas to the natural gas grid. An example is the NGF Nature Energy Holsted plant, which is commissioned in 2016. The plant produces 13 million m³ upgraded biogas with an input of approximately 400.000 tons per year [13].

Prediction of performance and costs

Data for 2015

Over the recent years there has been a considerable growth in the number of biogas plants in Denmark as well as neighboring countries, and biogas technology is in general placed in development category 3; *Commercial technologies, with moderate deployment*. However, there are major differences in the technologies from country to country with respect to the feedstock, the sizes of the plants, as well as the use

of the gas. In Germany, the focus has been on the use of energy crops in smaller plants, which supply gas for heat and power production. Sweden has a larger number of plants based on sewage water and household waste and focus is on upgrading the gas to supply the transport sector [6]. In Denmark, the growth in biogas production has focused on the use of animal slurry and agricultural residues, which today accounts for some 75% of the production. There is an expected potential for a considerable further growth [7].

Older plants producing cleaned but not upgraded biogas for use in gas engines for electricity production is well proven in Denmark, but the current development increasingly focusses plants for production of upgraded gas (SNG) for use in the natural gas network [5].

The basis for cost and performance for the years 2015 and 2020, as shown in the data sheets, is the larger Danish plants intended for upgraded biogas production.

Assumptions for the period 2020 to 2050

It is expected that the investment costs will decrease gradually due to learning curve effects, but not as significant as for other technologies, since many elements of a biogas plant is related to general industries, e.g. civil construction works and general process equipment, where learning curve effects are limited. As described, the technology is expected to be defined by a relatively nationally defined development and learning curve effects shall be seen in that context. For the period 2015 – 2020 the total biogas production in Denmark is expected to double from 7 PJ to 15 PJ [10]. It is estimated that such a doubling of installed capacity a learning curve progress rate of 0.9 will lead to a 10 % reduction in costs. For the periods 2020 to 2030 and 2030 to 2050, respectively, the accumulated build production capacity is also expected to double [11], considering a combination of installation of new plants and retrofit/replacements of old plants. Thus, similar reductions in costs are expected for each of these periods. It is important to notice that the further construction of biogas plants after 2020 is dependent on the future political framework conditions.

Operation costs (excluding costs of feedstock) are expected to decrease with half of the rates expected for investments. The O&M costs are measured per ton input, so a higher energy yield will further affect the energy price.

The biogas production is assumed to remain constant with constant input shares of the various feedstock. This may not be true if, for instance methods for improved energy yield are developed and implemented.

Uncertainty

The general uncertainty when calculating energy generation costs for a biogas plants is high, but the investment costs seem to contribute less than the operation costs. Data from existing biogas plants in Denmark show that the energy production per ton input as well as other cost determining factors is quite different from plant to plant [5]. Key parameters in relation to the energy output are composition of the input material and the processing time. The data in this technology catalogue consider a fixed composition of the input and a fixed processing time.

In relation to the costs, biomass purchase, transportation, auxiliary energy, and labor costs are important but may vary widely [5].

Data sheets

The capacity of biogas plants is commonly stated as tons per year and for most of the input material a calorific value is not relevant (e.g. manure). For compatibility with the template the energy of the biogas output is assumed to be 100%. Thus, the stated auxiliary energy consumption is stated in percent of the output energy.

The data sheets consist of a sheet for a basic plant using a mix of available feedstock sources as listed in table 1 and described in [8] and [9], but excluding straw, energy crops, garden waste and aquatic biomass.

The supplementary data sheet contains values for input of straw and industrial organic waste. The values refer to a part of a total plant processing only the straw or waste. It is thereby possible to model the production and costs of a plant with input of straw or waste by adding a 'basic plant'-part and a 'straw/waste input' part.

Data sheet Biogas plant, basic configuration

Technology	Biogas plant, basic configuration									
	2015	2020	2030	2050	Uncertainty (2020)		Uncertainty (2050)		Note	Ref
Energy/technical data					Lower	Upper	Lower	Upper		
Typical total plant size (MW output)	9,2	8,7	8,7	8,7	8,3	9,6	8,3	9,6	A	
- Inputs										
Biomass (tons/year)	365.000	365.000	365.000	365.000	365.000	365.000	365.000	365.000	A B	5/8/9
Aux. electricity (% of output energy)	3,7	3,8	3,8	3,8	1,9	6,7	1,9	6,7	A	5/8/9
Aux. electricity (kWh/ton input)	8,2	8,0	8,0	8,0	4,3	14,0	4,0	14,0		
Aux. process heat (% of output energy)	8,4	8,9	8,9	8,9	7,2	12,0	7,2	12,0	A	5/8/9
Aux. process heat (kWh/ton input)	18,6	18,6	18,6	18,6	16,0	25,0	15,0	25,0		
- Outputs										
Biogas (%)	100	100	100	100	96	110	95,8	110	F	
Biogas (GJ/ton input)	0,80	0,75	0,75	0,75	0,72	0,83	0,72	0,83	G	9
Forced outage (%)	0	0	0	0						
Planned outage (days per year)	10	10	10	10						
Technical lifetime (years)	20	20	20	20						
Construction time (years)	1	1	1	1						
Financial data										
Specific investment (mio €/MW output)	1,81	1,71	1,54	1,39	1,54	1,90	1,25	1,54	A H C	8/5
- of which equipment	-	-								
- of which installation	-	-								
Total O&M (€/MW/year)	198.785	194.715	197.702	195.722	154.398	245.575	150.001	252.439		
Total O&M (€/ton input/year)	5,03	4,63	4,70	4,66	3,52	6,43	3,42	6,61	A D I	8/5
- of which O&M, excl el. and heat (€/ton input/year)	4,11	3,67	3,49	3,31	2,81	5,05	2,54	4,56	A D I	8/5
- of which electricity (€/ton input/year)	0,52	0,55	0,80	0,93	0,29	0,97	0,47	1,64	K	
- of which heat (€/ton input/year)	0,41	0,41	0,41	0,41	0,41	0,41	0,41	0,41		
Technology Specific data										
Methane emission (Nm ³ CH ₄ /ton input/year)	0,44	0,42	0,42	0,42	0,17	0,88	0,17	0,88	J	12

Notes:

- A The production, investment- and operation costs are based on a plant with a yearly input of 365,000 tons and a mix of available feedstock sources as described in [9] and [8], but excluding straw, energy crops, garden waste and aquatic biomass. The available feedstock composition for 2015 is obtained by interpolation of 2012 and 2020 potentials. The feedstock composition after 2020 is assumed constant.
The output of a specific plant will vary depending on the actual feedstock composition.
- B Values are assumed valid for a range 200,000 - 400,000 tons per year
- C The investment includes a straw fired boiler for process heat.
- D All O&M considered fixed, assuming 8760 hours operation per year. Does not include costs for biomass purchase and transport. Data for biomass included in biogas plant, basic configuration, 2015, is included below. Source: Reference [5].

Biomass	Share, 2015	Share, 2020	Price per ton (€), incl transport
Manure (pig and cattle)	79,8%	83,8%	3,36
Deep bed material	8,0%	8,5%	6,71
Manure, stable	6,1%	0,2%	6,71
Straw	0,0%	0,0%	67,4
Industrial organic waste	1,0%	1,2%	40,3
Household waste	1,6%	1,2%	18,9
Energy crops	0,0%	0,0%	34,9
Other	3,5%	5,1%	27,9

- F For compatibility with the template the energy of the biogas output is assumed to be 100%. (For most of the input material a calorific value is not relevant)
- G A calorific value of methane of 35.9 MJ/Nm³ is used. The input material composition and the output is assumed constant after 2020.
- H Learning curve effects have been assumed 2015-2020: 10% reductions, 2020-2030: 10% reductions, 2030-2050: 10% reductions
- I Learning curve effects have been assumed 2015-2020: 5% reductions, 2020-2030: 5% reductions, 2030-2050: 5% reductions
Corresponding to 2% of the produced biogas, with lower value 0.8% and upper value 4.2%. This will vary and
- J can be reduced.
- K The cost of auxiliary electricity consumption is calculated using the following electricity prices in €/MWh: 2015: 63, 2020: 69, 2030: 101, 2050: 117. These prices include production costs and transport tariffs, but not any taxes or subsidies for renewable energy.

Data sheets Biogas plant, additional straw input

Technology	Biogas plant, additional straw input in the feedstock mix									
	2015	2020	2030	2050	Uncertainty (2020)		Uncertainty (2050)		Note	Ref
Energy/technical data					Lower	Upper	Lower	Upper		
Biogas from additional straw (MW output)	1,00								A B	
- Inputs										
Straw input (% of additional output)	199%	182%	182%	182%					A B	5/8/9
Straw input (tons per year)	4.337	3.957	3.957	3.957						
Auxiliary electricity input (% of additional output)	3,12%	2,85%	2,85%	2,85%						5/8/9
Auxiliary electricity input (kWh/ton straw)	63,00	63,00	63,00	63,00					A	
Additional process heat (% of additional output)	0,92%	0,84%	0,84%	0,84%						5/8/9
Auxiliary process heat (kWh/ton straw input)	18,60	18,60	18,60	18,60					A	
- Outputs										
Biogas (%)	100,0%	100,0%	100,0%	100,0%					A C	
Biogas (GJ/ton straw input)	7,3	8,0	8,0	8,0					A C	9
Residual organic material									D	
Forced outage (%)	0	0	0	0						
Planned outage (days per year)	10	10	10	10						
Technical lifetime (years)	20	20	20	20						
Construction time (years)	1	1	1	1						
Financial data										
Investment (€/MW)	407.676	371.930	371.930	371.930					AEG	8/5
Investment (€/ton straw input/year)	94,00	94,00	94,00	94,00					AEG	
Total O&M (€/MW/year)	47.387	44.727	52.704	56.692					AFG	8/5
Total O&M (€/ton straw input/year)	10,9	11,3	13,3	14,3					AFG	
- of which O&M, excl el. and heat (€/ton input/year)	6,55	6,55	6,55	6,55						
- of which electricity (€/ton input/year)	3,97	4,35	6,36	7,37					K	
- of which heat (€/ton input/year)	0,41	0,41	0,41	0,41						
Technology Specific data										
Methane emission (Nm ³ CH ₄ input/year)	4,0	4,4	4,4	4,4	1,8	9,2	1,8	9,2	H	12

Notes:

- A The data sheet shows the expected energy output and values for the input of industrial organic waste specifically. The values refer to a virtual part of a total plant processing the straw. A plant including increased share of straw may be composed by adding a basic plant part and straw processing part.
- B Values are assumed valid for adding a smaller part of straw to a total plant. Maximum share not assessed.
- C For compatibility with the template the energy of the biogas output is assumed to be 100%. (For the input material a calorific value is not relevant)
- D The energy content of residual organic material has not been evaluated due to lack of sources.
- E Investment in straw preparation equipment (57 Eur/ton/year) and proportional share of basic plant included. Biogas processing time is 25 days
- F All O&M considered fixed, assuming 8760 hours operation per year. Does not include fuel for process heat, electricity, biomass purchase and transport, see e.g. [5] and [8].

- G The value will vary with the quality of the input. Assumed average value used corresponding to 320 Nm³ CH₄ / ton VS, TS 42%, vs/ts 90%. [8].
- H Learning curve effects have not been considered. Will depend on actual deployment of technology.
- J Corresponding to 2% of the produced biogas, with lower value 0.8% and upper value 4.2%. This will vary and can be reduced.
- K The cost of auxiliary electricity consumption is calculated using the following electricity prices in €/MWh: 2015: 63, 2020: 69, 2030: 101, 2050: 117. These prices include production costs and transport tariffs, but not any taxes or subsidies for renewable energy.

Data sheet Biogas plant, additional industrial organic waste input

Technology	Biogas plant, additional industrial organic waste in the feedstock mix									
	2015	2020	2030	2050	Uncertainty (2020)		Uncertainty (2050)		Note	Ref
					Lower	Upper	Lower	Upper		
Biogas from additional ind. organic waste (MW output)	100%								A B	
- Inputs										
Ind. organic waste input (% of additional output)	125-200%	125-200%	125-200%	125-200%					L	
Ind. organic waste input (tons per year)	6.529	6.529	6.529	6.529						5
Aux. electricity (% of additional output)	0,77%	0,77%	0,77%	0,77%						5
Aux. electricity (kWh/ton waste input)	10,30	10,30	10,30	10,30					A	
Aux. process heat (% of additional output)	1,39%	1,39%	1,39%	1,39%						5
Aux. process heat (kWh/ton waste input))	18,60	18,60	18,60	18,60					A	
- Outputs										
Biogas (% of total input)	100,0%	100,0%	100,0%	100,0%					A C	
Biogas (GJ/ton ind. org. waste input)	4,8	4,8	4,8	4,8					ACG	5/9
Residual organic material									D	
Forced outage (%)	0	0	0	0						
Planned outage (days per year)	10	10	10	10						
Technical lifetime (years)	20	20	20	20						
Construction time (years)	1	1	1	1						
Financial data										
Investment (€/MW output)	276050	276050	276050	276050					AEH	8/5
Investment (€/ton waste input / year)	42,28	42,28	42,28	42,28					AEH	
Total O&M (€/MW/year)	49500	49904	52056	53132					AFH	8/5
Total O&M (€/ton waste input/year)	7,6	7,6	8,0	8,1					AFH	
- of which O&M, excl el. and heat (€/ton input/year)	6,5	6,5	6,5	6,5						
- of which electricity (€/ton input/year)	0,65	0,71	1,04	1,21					K	
- of which heat (€/ton input/year)	0,41	0,41	0,41	0,41						
Technology Specific data										
Methane emission (Nm3 CH4 input/year)	4,0	4,4	4,4	4,4	1,8	9,2	1,8	9,2	H	12

References

- [1] "Danish Climate Strategy", Ministry of Environment, February 2003.
- [2] Sulphur emissions from the use of biogas, MST project 1796, Danish environmental and food agency, 2015.
- [3] "Øget produktion og anvendelse af biogas i Danmark" (Increased production and use of biogas in Denmark; in Danish), Danish Gas Technology Centre, 2009.
- [4] "Forsknings- og udviklingsstrategi for biogas" (Research and development strategy for biogas; in Danish), Danish Energy Agency, Energy Technology Development Programme (EUDP) and Energinet.dk, August 2009.
- [5] "Udvikling og effektivisering af biogasproduktionen i Danmark – Delrapport 1 og 2", Danish Energy Agency Biogas Taskforce 2015.
- [6] "Teknologivurdering af biogas", Danish Energy Agency, 01-09-2014
- [7] "Biogas i Danmark – Status, barrierer og perspektiver", Energistyrelsen, 2014
- [8] "Anvendelse af biogas til el- og varmeproduktion, analyser for Biogas Taskforce", Ea Energianalyse, 2014
- [9] "Biomasse til biogasanlæg i Danmark - på kort og langt sigt", Agrotech, November 2013
- [10] Danish Energy Agency, Retrieved from <http://www.ens.dk/forventet-biogasproduktion-frem-2020> (May 27th 2016)
- [11] "Energiscenarier frem mod 2020, 2035 og 2050", Danish Energy Agency, 2014.
- [12] "Miljøeffekter af metanlækage på biogasanlæg", Agrotek, 2015
- [13] <http://holsted.natureenergy.dk/Anlaegget>
- [14] "Biogas – Grøn energi", Peter Jakob Jørgensen, 2009.

82 Biogas Upgrading

Contact information:

Danish Energy Agency: Jacob Hjerrild Zeuthen and Filip Gamborg

Author: EA Energianalyse

Publication date

June 2017

Amendments after publication date

Date	Ref.	Description
-	-	-
-	-	-

Qualitative description

Brief technology description

Biogas produced from various kinds of organic material, such as organic waste and residues, animal manure or energy crops, can be upgraded to biomethane using different technologies. After upgrading, the gas can be injected into the natural gas grid.

The input for upgrading facilities is raw biogas from an anaerobic digester with a typical methane (CH₄) content of 50-70% and a content of 30-50% carbon dioxide (CO₂) plus a minor content of hydrogen, nitrogen (N), oxygen (O), hydrogen sulphide (H₂S) and ammonia (NH₃). The composition of the biogas varies based on the specific mix of the input.

Before injecting the gas into the natural gas grid, it is necessary to remove the content of CO₂, thereby increasing (“upgrading”) the heating value of the gas. Depending on the composition of the raw biogas, it is also necessary to remove water moisture, particles, hydrogen sulphide (H₂S), ammonia (NH₃) and nitrogen (N). As it is rather expensive to remove nitrogen (N), this is rarely done. Hydrogen sulphide needs to be removed before further use as it is a corrosive gas. Upgrading can also take place by catalytic conversion of the CO₂ to methane by adding hydrogen. This technology is described in another chapter.

Quality requirements for biomethane is described in Gasreglementet section C-12. Bestemmelser om gaskvaliteter. (14. december 2012)².

Typically, the investment costs for a complete upgrading system connected to a natural gas grid can be categorised using the following main components excluding the biogas plant itself,

- The upgrading plant
- Additional equipment to treat the methane slip (where necessary)
- Compressor units (where necessary)

² <https://www.retsinformation.dk/Forms/R0710.aspx?id=144715>

- Grid connection plant,

The heating value of upgraded biogas is approximately 10% lower than the heating value of natural gas, which causes challenges for example in relation to proper billing of costumers. One approach to solving the problem is to add propane to the upgraded gas thereby increasing the heating value. Propane addition is however associated with considerable costs and the Danish gas distribution companies have therefore decided to solve the problem through measurements of the gas quality rather than adding propane. By connecting the upgrading plants at MR stations, gas companies are able to keep track of the gas quality in different parts of the distribution network and thereby also ensures proper billing of costumers. Therefore, costs related to propane addition are not considered in this technology sheet.

Upgrading

The main purpose of upgrading is the removal of CO₂, and the capacity of the upgrading plant is usually stated in Nm³ raw biogas. The grid connection plant encompasses equipment for measuring gas quality, odourisation of the gas and the concrete mechanical grid connection. Other options include further measurements of the gas quality within distribution grids.

Today there are five available upgrading technologies but some are less commercially mature than others:

- Water scrubbing
- Amine scrubbing
- Pressure swing adsorption (PSA)
- Membrane separation
- Organic physical scrubbing

Another technology – cryolithic separation – is under development and little data is currently available. Also, enzymatic upgrading technology is under development.

Currently, the most common upgrading technology is water scrubbing, followed by chemical/amine scrubbing and PSA. Today, there are no PSA plants in operation in Denmark. The vast majority of the existing upgrading facilities are located in Germany and Sweden.

In a water scrubber, the absorption process is purely physical. The biogas is put in contact with water by spray or bubbling through to wash out the CO₂ but also hydrogen sulphide, since the gases are more soluble in water than methane. The pressure in a water scrubber plant is typically higher than the natural gas distribution grid pressure at a connection point, in which case no further compression is necessary for grid injection of the biomethane.

Amine scrubbing uses chemical absorption of CO₂ in amines, which are regenerated in a stripper when heated. This process has the highest efficiency in terms of methane conservation. Amine scrubbing can be integrated using high-temperature excess heat (120-150°C) from other processes and the excess heat from the upgrading plant itself can also be used in low-temperature (65°C) applications, for example biogas digesters. In addition, electricity is required for compression for grid connection.

The PSA separates some gas components from a mixture of gases under high pressure according to the molecular characteristics of the components and the affinity for an adsorbent material (often active carbon). The process then swings to low pressure to desorb the adsorbent material.

The membrane separation method utilises membranes, which consist of hollow fibres bundled together. The membranes are permeable to ammonia, water and carbon dioxide. Nitrogen and methane only passes through the membrane to a very low extent while oxygen and hydrogen sulphide pass the membrane to some extent. Typically, the process is carried out in two stages. Before reaching the membranes the gas passes through a filter that catches water and oil droplets that would otherwise affect the efficiency of the membranes. Besides that, hydrogen sulphide is typically removed by means of active coal.

Organic physical scrubbing is like the water scrubbing technology with the difference that the CO₂ is absorbed in an organic solvent such as the traded solvents Selexol or Genosorb.

The figure below shows the specific investment costs per raw biogas inlet for the water scrubber, amine scrubbing, PSA, membrane separation (Membrane) and organic physical scrubbing (Genosorb). As the figure clearly illustrates, the economy of scale is significant up to a certain point.

The technology data sheet in this catalogue only focus on the water scrubbing plant, but as seen from the figure below it is expected that the investments costs of the five different technologies are at comparable levels [2].

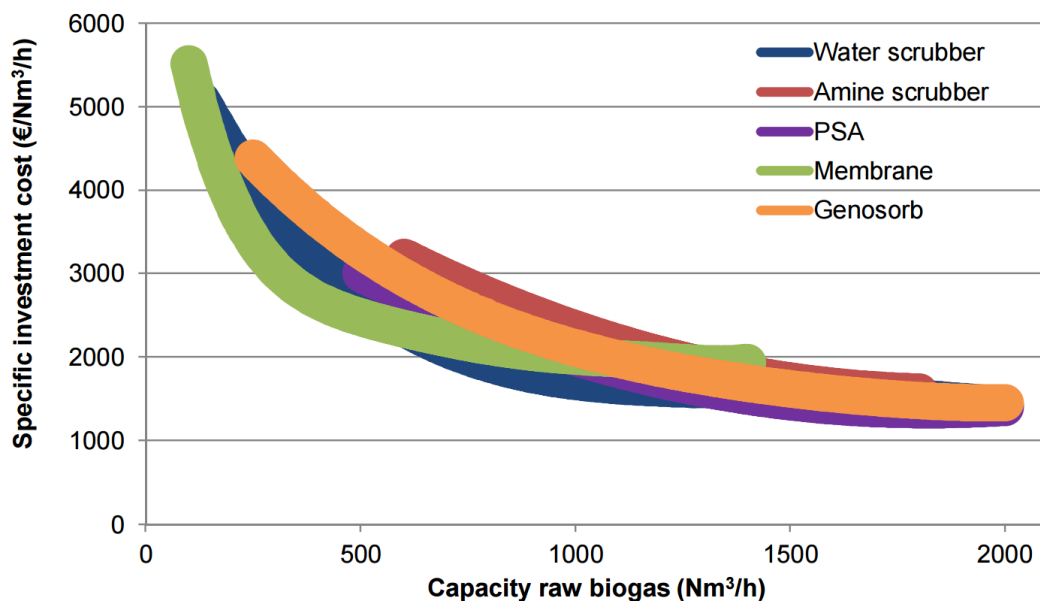

Figure 1: Specific investment costs for different biogas upgrading technologies. Genosorb is organic physical scrubbing. Source: SGC (2013).

Treatment of off-gases

The waste gases from an upgrading plant contain methane in a small concentration, but seldom enough to maintain a flame without addition of natural gas or biogas. One way of limiting the methane slip is to mix the off-gas with air used for combustion for heating the biogas digesters. Alternatively, the methane can be oxidized by regenerative thermal or catalytic oxidation.

The need for off-gas treatment depends on the methane slip from the specific plant. Plants using water scrubbing technology or PSA technology would often require tail-end solutions to decrease the methane slip [2].

Grid connection plant

In conjunction with the gas treatment plant, a grid connection facility should be established. For larger upgrading plants the local distribution network will in many cases not be able to take all the produced gas at all seasons. In these situations, the gas needs to be further pressurised from 4-7 bar to 40 bar, to be fed into the natural gas transmission network. In addition, measurement regulation and odourisation equipment is required. Further to this, but not included in the data sheet costs, is the connection pipeline to the gas grid.

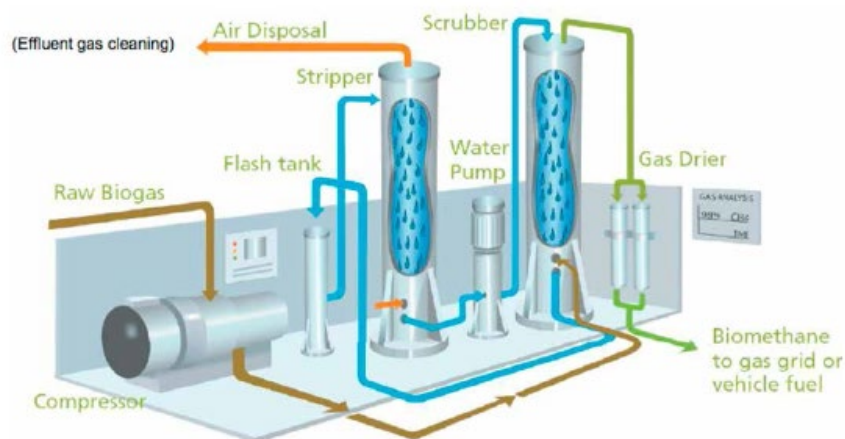

Figure 2: Principle of the water scrubber plant. Source: SGC (2013).

Input

- Raw biogas from a biogas plant.
- Electricity (or heat depending on the technology) for upgrading process.
- Electricity for compression.
- Smaller amounts of water and various chemicals.

Output

- Upgraded biogas with 95-99 vol. % methane, carbon dioxide and some nitrogen and oxygen [7].
- Waste gas containing mostly CO₂.

Energy balance

As shown in the figure below, the power consumption of the upgrading processes varies, but it ranges from approximately 0.2 to 0.3 kWh/Nm³ raw biogas. As an exception, the amine scrubber has a heat demand of around 0.5 kWh/Nm³ raw biogas, but a lower electricity consumption. The heat should be supplied at 120-150 °C and 80% of the heat can be reused in low-temperature

(65°C) applications [2].

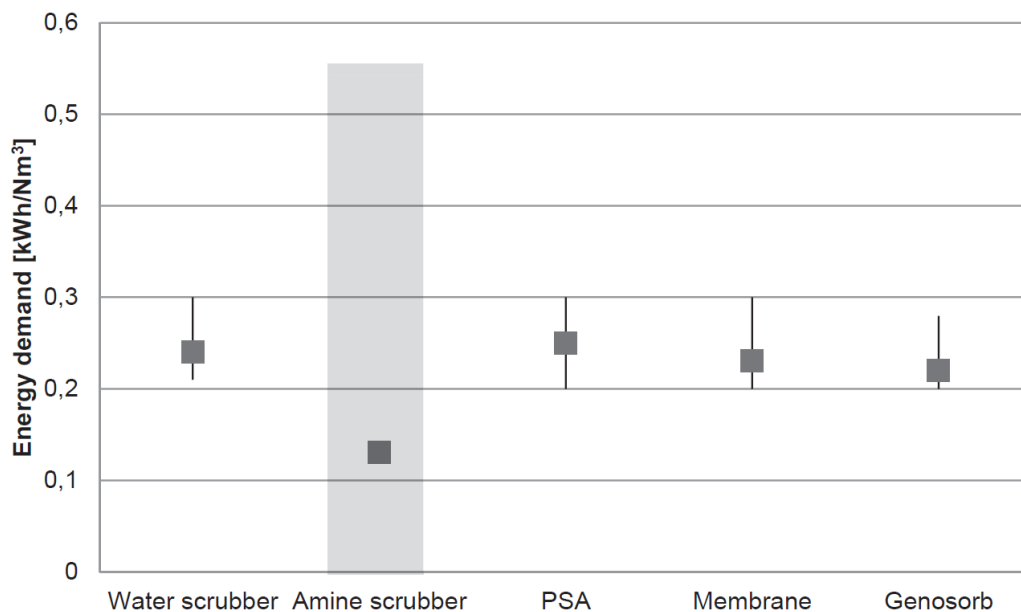

Figure 3: Electricity consumption (kWh/Nm³ raw biogas, indicated as box and line) for the upgrading technologies, water scrubber, chemical/amine scrubber, PSA, membrane separation and organic physical scrubbing (Genosorb). Heat consumption shown as column. Source: SGC (2013).

In the upgrading process, there is typically a methane slip of up to around 1%, meaning that approximately 99% of the inlet methane exits as product [2]. Details for each technology are given in the section about environmental issues below.

When comparing the energy balance of the upgrading technologies it is important to consider excess pressure compared to required grid connection pressure.

Typical capacities

Different upgrading facilities are available from several suppliers in a broad range of capacities.

Typical capacities vary from upgrading technology and from location to location. In Sweden, the most common sizes are around 600, 900 and 1,800 Nm³ raw biogas/h, while the most common in Germany is around 700 and 1,400 Nm³ raw biogas/h.

Denmark has in 2016 around 18 biogas plants that supply biomethane to the natural gas grid. Typical sizes for newer plants in Denmark are in the range of 1.000 – 2000 m³ biomethane per hour.

Regulation ability

Biogas upgrading plants can down regulate to 50% of full load [5].

Advantages/disadvantages

Upgrading of biogas to biomethane and injection in the natural gas grid makes it possible to decouple demand and consumption. Local use of raw biogas for CHP has until now made production dependant on local heat demand. Upgrading to biomethane creates a renewable fuel which can be transported and stored in the central gas grid and used where and when needed throughout Europe in conventional gas applications.

A disadvantage is the electricity consumption and relatively large investments connected with the upgrading.

Compared with another green gas technology, namely Bio SNG based on thermal gasification of biomass, upgraded biogas production is easier to decentralize, has less environmental impacts (emissions from chimneys), and the residuals has a good value for agriculture. Biomethane is a more mature technology where Bio SNG is still at demonstration level.

The different upgrading technologies each have their advantages and disadvantages respective to each other, but this will not be further discussed here.

Environment

Besides the energy consumption for operation, biogas-upgrading technologies have two other major environmental issues depending on the technology: the consumption of water and chemicals and a methane slip/emission.

Only the water scrubber and the amine scrubber use water – respectively 0.0004-0.004 m³/Nm³ and 0.00003 m³/Nm³ raw biogas. The chemical consumption for the water scrubber and amine mainly consist of anti-foaming. Furthermore, the amine scrubber has a demand for amine to account for the loss of amines in the process. During normal operation only minor amounts of amine are lost [2].

The removal of hydrogen sulphide requires active charcoal for both PSA, physical scrubbing (Genosorb), membrane separation and amine scrubbing. The highest reported chemical requirement is 0.00003 kg/Nm³.

The highest methane slip among the technologies is reported to be the one from PSA with 1.8%-2%, followed by the water scrubber with 1%, 0.5% for membrane separation and the lowest slip from amine scrubbing of 0.1%. In principle, physical scrubbers have a higher slip than the other technologies but the methane is utilized internally. The methane slip can be eliminated if the off-gas from the upgrading plant is treated in a regenerative thermal oxidation (RTO) plant.

Research and development

As noted above it is expected that the research and development and the competition between the different upgrading technologies will lead to incremental improvements of the technology and, to some extent, a reduction of costs.

Cryogenic upgrading

Regarding biogas and biomethane there may be a potential in the development of cryogenic treatment for upgrading biogas and for the condensation of upgraded biomethane to liquefied biogas. However, today the technology deployment is limited by operational problems.

Compared to other upgrading technologies cryogenic upgrading may have a lower energy demand for upgrading, no contact between gas and chemicals, production of pure CO₂ as a side product and the possibility to produce liquefied biomethane (LBG) and to remove nitrogen from the gas stream.

Enzymatic upgrading

The Danish Energy Technology Development and Demonstration Program (EUDP) supports new enzymatic upgrading technology in the project “Demonstration of a Novel Biogas Upgrading Technology”. An enzymatic upgrading process has been developed and will be demonstrated in a full-scale biogas upgrading plant using biogas from waste water treatment. The demonstration plant has been in operation from mid-2015.

The CO₂ is captured in a non-volatile solvent with a biocatalyst in an absorber column. The biocatalyst accelerates the CO₂ absorption using enzymes. Afterwards the CO₂ is removed from the solvent in a stripper column. The technology integrates enzymes to create an industrial biocatalyst that can be readily incorporated into conventional chemical absorption processes for CO₂ removal. The demonstration includes large-scale production of enzymes and biocatalyst. The enzymatic upgrading process is anticipated to be more energy-efficient and cost-effective than commercially available upgrading technologies. A reduction in biogas upgrading cost by 25 % is expected.

Examples of market standard technology

NGF Nature Energy Holsted Water scrubber upgrading plant 2015, 13 mio Nm³ biomethane per year. <http://holsted.natureenergy.dk/Anlaegget>

Sønderjysk Biogas Bevtoft, 2016, 21 mio Nm³ biomethane per year. Applies amine upgrading technology. <http://www.soenderjyskbiogas.dk/biogasanlaegget/>

Bigadan Horsens Bioenergi, 2014, 10 mio Nm³ biogas per year. Water scrubber and amin based upgrading plants. <http://bigadan.com/c/cases/horsens-bioenergi>

Assumptions and perspectives for further development

On a global scale, there has been a significant increase in the number of plants – especially since 2006. In Denmark, the market took off in 2014.

Until around 2008 PSA and water scrubber plants were dominating, but since then also the chemical scrubber (mainly amine scrubbers), the organic physical scrubber and membrane technologies have played an increasingly important role (see figure below).

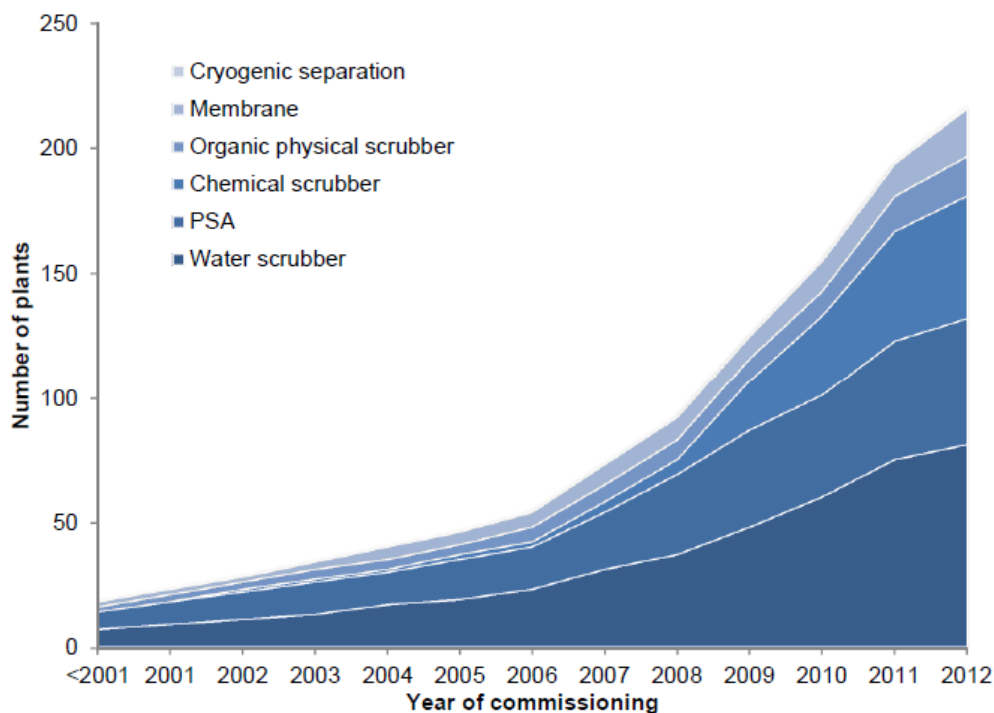

Figure 4 Global development in the number of upgrading plants and year of commissioning for the various technologies. Source: SGC (2013).

Currently, the biomethane production costs for the different mentioned commercially available technologies are around the same level. Just a few years back, amine systems were still only used as demonstration plants, whereas today the systems are sold and constructed in different standardized sizes. Water scrubbing and PSA have been mature technologies for many years, and only incremental technology development is expected, while cryogenic upgrading is a technology under development and demonstration.

An important aspect of biomethane market deployment is technical standards. Therefore, work is ongoing to establish a common European standard for injection of biomethane into the natural gas grid systems and for use as vehicle fuel within the European Biogas Association (EBA) and CEN project committee CEN/TC 408.

In Denmark, there is still relatively few upgrading plants but it is assessed that most new biogas plants will have upgrading facilities, so that the total production of upgraded biogas will amount to 8 PJ in year 2020 out of a total biogas production of 14 PJ [6].

Based on the above, the upgrading technology in general is considered to lie in between the two categories “3 Commercial technologies with moderate deployment” and “4 Commercial technologies, with large deployment”.

It is assumed that the growth will continue so that the Danish production of upgraded biogas will double in the period 2015 to 2020 and in the period 2020 to 2030. However, the total growth rate of the industry is likely to be smaller, considering less growth potentials in other countries where many plants are already operating. Thus, a moderate learning curve rate of 0.90 for investment and O&M costs is here assumed for each of the periods 2015-2020, 2020-2030 and 2030-2050.

Further, it is here assumed that one or more of the newer and currently less developed technologies (e.g cryogenic and membrane technologies) will take over from 2030 and that this can lead to lower methane slip (close to zero) and 50% reduction of the electricity consumption, which is already achievable today with the amine scrubbing technology [2, 7].

Additional remarks

Methanation of biogas by addition of hydrogen is an alternative technology, in which the CO₂ is converted to methane instead of releasing it to the atmosphere.

Data sheets

Data for an upgrading plant with a biogas input of 1.000 Nm³ is presented below. For the projection years 2015 and 2020, the data sheet is based on a water scrubber plant. By 2030, one or more of the newer and currently less developed technologies (e.g. cryogenic and membrane technologies) are expected to take over leading to a reduction in the plant's electricity consumption.

Technology	Biogas upgrading								Not e	Ref
	2015	2020	2030	2050	Uncertainty (2020)		Uncertainty (2050)			
Energy/technical data	Lower		Upper		Lower		Upper			
Typical total size (MJ output/s)	5,92	5,92	5,92	5,92					A G	
Typical total size (Nm ³ biogas/h)	1.000	1.000	1000	1000					A B	1/4
Capacity (Nm ³ biomethane/h)	594	594	594	594					A B	
- Inputs										
Biogas (% of biogas input)	100%	100,0	100,0	100,0						
Auxilliary electricity for upgrading (% of biogas input)	4,3%	4,3%	2,2%	2,2%	3%	4,3%	1,6%	3,2%	A D J	1/2/4 /7
Auxilliary electricity for compression (% of biogas input)	1,0%	1,0%	1,0%	1,0%					A F	2/4
Heat (% of biogas input)	0,0%	0,0%	0,0%	0,0%						2/4
- Outputs										
Biomethane (% of biogas input)	99,0%	99%	100%	100%					I	2
Waste gas (% of biogas input)	1%	1%	0,1%	0,1%					I	
Waste heat (% of biogas input)	5,3%	5,3%	3,2%	3,2%						
Forced outage (weeks per year)	1	1	1	1						
Planned outage (weeks per year)	1	1	1	1						
Technical lifetime (years)	15	15	15	15						
Construction time (years)	0,5	0,5	0,5	0,5						
Financial data										
Specific investment, upgrading and methane reduction (€/MJ/s input)	335.000	302.000	272.000	245.000	268.000	318.000	172.000	287.000	C D	1/2/5 /7
Specific investment, grid injection at 40bar (€/MJ/s input)	134.000	121.000	109.000	98.000	107.000	127.000	69.000	115.000	F	5
Fixed O&M (€/MJ/s input / year)	11.800	10.600	9.500	8.600	9.400	11.200	6.000	10.100		2
- of which fixed O&M costs upgrading and methane reduction, excl. el. (€/MJ/s input / year)	8.400	7.600	6.800	6.100	6.700	8.000	4.300	7.200		2

- of which fixed O&M costs grid injection, excl. el. (€/MJ/s input / year)	3.400	3.000	2.700	2.500	2.700	3.200	1.700	2.900	H	2
Variable O&M ((€/GJ input)	0,93	1,03	0,88	1,02					H	
- of which electricity (€/GJ input)	0,93	1,03	0,88	1,02					E	2/4/7
Technology specific data										
Methane slip / emission (%)	1%	1%	0,1%	0,1%					I	2
Minimum load (% of full load)	50									7
CO2 removal, %	98,5									1

Notes:

- A Corresponding to 1.000 Nm³ biogas input, assuming a methane content of the raw biogas of 60% and an average gross conversion efficiency of approx. 98,5%.
- B Values are assumed valid for a range 500-1,500 Nm³ biomethane per hour
- C Values include upgrading, methane reduction and grid injection facilities
- D Based on a water-scrubber technology based plant, alternative technologies have comparable values in terms of total upgrading costs.
For a plant of double capacity (2000 Nm³/h) the realtive price is expected to be 20-25% lower [1,3]
- E The cost of auxiliary electricity consumption is calculated using the following electricity prices in €/MWh: 2015: 63, 2020: 69, 2030: 101, 2050: 117. These prices include production costs and transport tariffs, but not any taxes or subsidies for renewable energy.
- F Injection in natural gas grid at 40 bar
- G Based on a lower calorific value of 36 MJ/Nm³ and 8760 hours per year
- H O&M costs are estimated to 2.5% of investment per year, in accordance with [2]
- I Assuming that, by 2030, methane slip can be reduced to levels seen today for amin scrubbing technology. Methane slip is assumed to be the same as waste gas assuming that the plant is not equipped with a regenerative thermal oxidation (RTO) plant. If the the off-gas from the upgrading plant is treated with a regenerative thermal oxidation (RTO) plant the methane slip can be eliminated.
- J Assuming that, by 2030, one or more of the newer and currently less developed technologies (e.g. cryogenic and membrane technologies) will take over.
This can lead to a 50% reduction of the electricity consumption, which is already achievable today with the amine scrubbing technology.

References

- [1] "Biogas upgrading – Technical review, Energiforsk report 2016:275, Energiforsk AB, 2016.
- [2] "Biogas upgrading – Review of commercial technologies", SGC Rapport 2013:270, SGC, 2013.
- [3] "Global status for upgrading of biogas", Technology and Economy, Pedersen, Aksel Hauge, DONG Energy, November 2013.
- [4] "Biogas upgrading technologies – developments and innovations. Task 37 – Energy from biogas and landfill gas", Petersson & Wellinger, IEA Bioenergy, 2009.
- [5] "Anvendelse af biogas til el- og varmeproduktion", Ea Energianalyse, 2014.

- [6] Ingeniøren online (7. May 2016). (<https://ing.dk/artikel/byggeboom-naesten-tredobler-produktionen-af-gron-gas-i-2020-183940>)
- [7] "Introduktion til produktion af biometan fra biogas", Biometan Regioner, 2013.

Biomass Gasification - general introduction

Contact Information

- Danish Energy Agency: Jacob Hjerrild Zeuthen and Filip Gamborg
- Author: Ea Energy Analyses, Malthe Jacobsen, Morten Tony Hansen
- Reviewer:

Publication date

March 2017

Amendments after publication date

Date	Ref.	Description
-	-	-
-	-	-

This is a general introduction to thermal gasification of biomass. Different technology tracks are further described in separate chapters, including the further processing and use of the gas.

Biomass can be gasified thermally to extract the energy to a gas for further use in different processes. The raw material will typically be solid biomass with a high content of lignocellulose such as wood chips, wood pellets, straw, or other solid residues from agriculture, forestry or industry.

Gasification takes place by heating the biomass in an atmosphere with less oxygen than required for complete combustion, and possibly by adding another gasification agent. The product of a gasification process is a mixture of mainly hydrogen, carbon monoxide, carbon dioxide, methane, water, and smaller amounts of higher hydrocarbons. Besides this the raw 'producer gas' will also contain components from the feedstock or gasifying agent such as sulphur, nitrogen or chlorine as well as impurities such as tar and dust, depending on the temperature and properties of the process.

After gasification the gas can be cleaned in various steps that may include dust filtration/washing, tar conversion/separation, sulphur and chlorine removal. The necessary degree of cleaning is determined by the further use of the gas.

The raw gas can then be converted and used in different ways. It can be used directly in combustion in boilers or gas engines for heat and power production, or it can be further processed to serve as raw material in the production of synthetic natural gas (SNG) or various liquid biofuels.

Gasification principles

A basic segregation is made between direct and indirect gasification.

In *direct gasification* heat is formed in the gasification process itself by partial combustion of the biomass. In such processes, flue gasses and product gas will be mixed. In case atmospheric air is used as gasification agent, the gas will contain nitrogen, which makes it unsuitable for SNG production.

In direct gasification one principle is to use air as gasification media in combination with steam, from the feedstock material itself, or added. This represents a traditional gasification technology, which is well known and used in smaller scales to produce a low-quality combustible gas. Since air is used, the gas contains nitrogen. Another principle in direct gasification uses pure oxygen mixed with CO₂ or steam. Here nitrogen can be avoided in the product gas which makes it more suitable for SNG production.

In *indirect gasification* heat is transferred to the gasification process by means of a media such as a gas or a movable bed material. But the heat is formed outside the reactor doing the gasification itself, often in a parallel combustion process. Thus, flue gas and product gas can be separated.

Indirect gasification can be done by pyrolysis where the biomass, when exposed to heat, will degrade to a gas with relatively high methane content, a fraction of tar and a solid residue of char (in parallel to the coke left from coal gasification) with a high content of carbon. If steam and/or CO₂ are added to the process the biomass can be fully converted to gas. As hydrogen from the steam and carbon from CO₂ take part in the formation of hydrogen and carbon monoxide gasses.

Gasifier designs

Gasification technologies can also be classified by different designs of the gasifiers. There exists a large variety of different designs in Denmark and abroad of which many are still at a demonstration scale, and a description of these is not provided here. Such designs can use one or a combination of the above-mentioned principles for biomass gasification. Further descriptions can be found in e.g. [6].

Here it is chosen to distinguish among three main technology tracks which mostly accounts for the scale and likely applications. Bearing in mind that each of these contains a variety of different solutions and combinations, it will be possible to generalize some of the properties of these in terms of main characteristics such as, efficiencies, possibilities for up-scaling and financial properties:

- Biomass gasification, fixed bed, for producer gas

- Small scale (1 - 25 MJ/s input)
- Mainly for heat and power generation (without methanation)

- Biomass gasification, for bio-SNG
 - Medium to large scale (20 - 400 MJ/s input)
 - Circulating fluid bed gasifiers (CFB), or similar

- Biomass gasification, entrained flow, for production of liquid fuels
 - Large scale (>500 MJ/s input)
 - In this catalogue, focus is on production of bio diesel by the Fischer Tropsch process.

83 Biomass gasification, fixed bed, for producer gas

Contact Information

- Danish Energy Agency: Jacob Hjerrild Zeuthen and Filip Gamborg
- Author: Ea Energy Analyses, Malthe Jacobsen, Morten Tony Hansen
- Reviewer:

Publication date

March 2017

Amendments after publication date

Date	Ref.	Description
-	-	-
-	-	-

Qualitative description

Brief technology description)

Fixed bed gasifiers are smaller scale plants (<10 MW output) with direct gasification processes that can be either updraft or downdraft, and that can be staged into different process steps.

The primary use of the gas will be in co-generation of heat and power (CHP), or in heat-only boilers. In this catalogue the device for conversion of the producer gas is not included.

For the fixed bed technologies, it is assumed that atmospheric air is used as gasifying agent in direct gasification. Thus, the gas will contain nitrogen. The nitrogen content and the limited possibilities for upscaling make the fixed bed technologies less interesting for larger plants with further upgrading to synthetic natural gas (SNG) or production of liquid biofuels based on syngas.

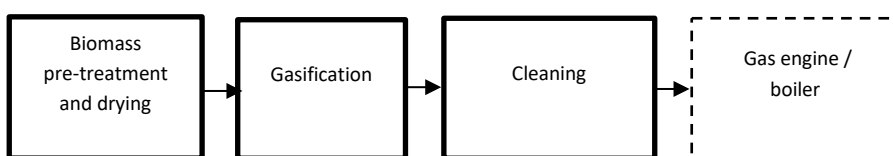

The updraft (or counter current) gasifier has been used for the last 75-100 years with fossil fuel for electricity, heat, steam and industrial processes such as burning of ceramics, glass making, drying and town gas.

It is characterized by the biomass feedstock and the gas having opposite flow directions. The biomass is converted through several stages. Up to 100°C the water is vaporized. By pyrolysis (extra heating and limited addition of oxygen) the dry fuel is converted to a tarry gas and a coke residue. Subsequently, the coke residue is gasified at 800-1,200°C, while water vapour and/or oxygen (air) is added.

The gas has low temperature (~75°C) but a large content of tar, typically 30-100g/Nm³. Depending on the process, the tar shall either be incinerated or cracked before it is cleaned of particles etc.

Producer gas primarily consists of the components N₂, H₂, CO, CO₂, CH₄, and water. The use of atmospheric air and direct gasification limits the calorific values of the gas to about 6 MJ/Nm³ for the dry cleaned gas from an updraft gasifier [8].

For internal combustion engine applications, gas from updraft gasifiers needs tar removal and possible effluents from the cleaning step need to be handled.

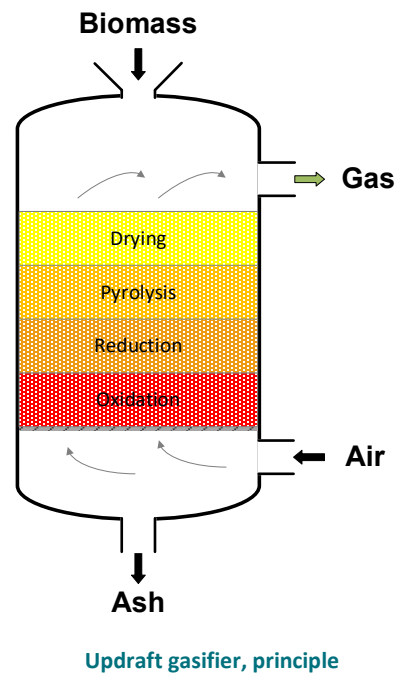

The downdraft (or co-current) gasifier has the same flow direction of the biomass feedstock and the gas. The biomass is converted through several stages. Up to 100°C the water is vaporized. By pyrolysis the dry fuel is converted to a tarry gas and a char residue. Subsequently, the char residue is gasified at 800-1,200°C, while water vapour and/or oxygen (air) is added. By adding air to the char zone, the tar content in the producer gas is reduced and amongst fixed bed gasifiers the downdraft type produce gas with the lowest level of tar.

In staged downdraft gasification, pyrolysis and gasification are separated in two reactors, enabling a partial oxidation of tar products between the stages. Thus, staged gasifiers are producing a gas with low tar content, which is essential for engine operation. The tar content is often below 100 mg/Nm³ and can be below 10 mg/Nm³.

The pyrolysis process can be driven by either internal or external heating. Internal heating is performed by addition of air/oxygen consuming a part of the energy content in the fuel, while external heating utilises waste heat from the produced gas and from the engine to dry and pyrolyse the fuel.

The data in the table are valid for external heating, as this results in higher efficiencies.

Producer gas primarily consists of the components N₂, H₂, CO, CO₂, CH₄, and water. The use of atmospheric air and direct gasification limits the calorific values of the gas to 4.5-6 MJ/Nm³ for the dry, cleaned gas from a downdraft gasifier [8].

For internal combustion engine applications, producer gas from downdraft gasifiers may need only cooling and dust removal.

Input

- Solid biomass such as wood chips, pellets, chunks and briquettes, industrial wood residues, demolition wood and energy crops can be used
- Auxiliary electricity for process machinery.

Requirements to moisture content and size of the fuel depends on the design of the reactor and the process: Updraft gasifiers can take fuels with up to 50% water content, whereas downdraft gasifiers require fuel with a maximum of 15-20% water. In practice, artificial drying is often integrated with the gasification plant to ensure a feedstock of constant moisture content [8]. Downdraft gasifiers typically need homogeneous sized biomass input to avoid packing of bed and subsequent pressure loss across the fuel bed.

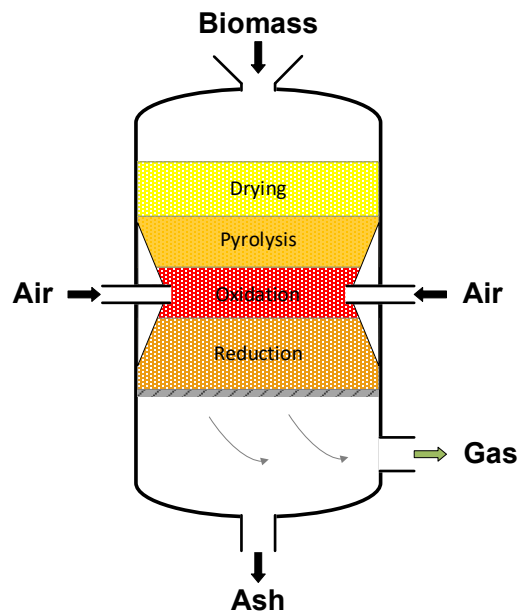

Downdraft gasifier, principle

Output

- Producer gas suitable for combustion in gas engines, gas turbines or boilers.
- Recoverable heat for domestic heating.
- Ash, slag and possibly tar and/or effluents from cleaning step.

The range of composition of the producer gas is rather broad according to technology, fuel, operational conditions etc. Levels from two concepts appear from the table below [8].

Component	vol%
H ₂	19 - 31
CO	18 - 23
CO ₂	12 - 15
CH ₄	1 - 5

Ranges of composition of producer gas from fixed bed gasifiers.

Energy balance

Updraft gasifier:

Based on an energy input of wet biomass (100%), a producer gas energy output of 40-65%, and a heat output of 10-20% can be obtained [8].

Staged downdraft gasifier:

Based on an energy input of wet biomass (100%), a producer gas energy output of 75-85%, and a heat output of 10-20% can be obtained [8].



Sankey diagram of fixed bed gasifier in 2030.

In many cases, a fixed bed gasifier will be part of a CHP system with an ICE genset that provides electricity also to cover the internal electricity demand. In this case, where the gasifier is standing alone and the system output is product gas and heat, an electricity input is needed.

The heat loss may in many cases be lowered by condensation of the producer gas and circulation of the heat to drive the gasification process.

Typical capacities

Updraft gasifier: 0.08 – 10 MWe (0.2-25 MJ/s fuel)

Downdraft/staged downdraft gasifier: 0.04 – 2 MWe (0.15-5 MJ/s fuel)

Capacities above these levels are typically increased by parallel installation of units. [8], [2].

Regulation ability

Gasifier output can be regulated within few seconds for downdraft gasifiers, and within minutes for updraft gasifiers. Start-up time from cold condition depends on plant sizes and design, in any case several hours to days. Minimum loads of 10-20% can be obtained for updraft-, and 25-30% for downdraft gasifiers [6]. Gasifiers are typically to be kept in continuous operation.

Space requirement

The main space requirements typically relate to the storage and handling of biomass feedstock, which can be assumed to correspond to biomass boilers.

Advantages/disadvantages

Compared with other gasification technologies, fixed bed gasifiers - and especially the downdraft types - provide a simple way of generating a gas clean enough to be used in an internal combustion engine for CHP. However, they generally have limited possibilities for upscaling, especially the downdraft types, as maintenance of a stable bed becomes increasingly challenging in larger cross sections. This is the reason behind parallel installation of units to increase capacity of a site. Furthermore, air as gasification media makes the gas unsuitable for methanation.

The updraft gasifier has limited requirements to fuel quality, i.e. the contents of moisture and ash. Furthermore, the gasifier can ramp up and down thereby offering flexibility both electricity generation and for supplying heat to district heating grids.

The downdraft gasifiers can also be tailored to a large variety of fuel qualities and capacity demands, and generally produces less tar.

Gasification of biomass for use in decentralized combined heat and power production can decrease the emission level compared to power production with direct combustion and a steam cycle.

Compared with alternative small-scale biomass-based electricity generation technologies, the gasifier / engine plants can reach higher net electrical efficiencies, typically up to 30% in CHP mode [2]. Existing natural gas fuelled engines can be converted to run solely on producer gas, or on a combination of producer gas and natural gas. When a spark ignition engine is converted to operation on producer gas its energy input capacity is derated to about 40-50% due to the lower calorific value of the gas [7]. One disadvantage compared to a natural gas-powered engine is the long start-up time of the gasifier (from cold). Also, excessive soot-formation may occur at start/stop.

Environment

Emissions from generation of biomass gases are very limited. Emissions from utilisation of gases from gasifiers may occur at each process step:

- gaseous emissions (exhaust gas, possible leakages)
- liquid emissions (scrubbing water, scrubbing wastes, condensates, bio-oil)
- solid emissions (ash, dust)

Generally, the environmental aspects of biomass gasification are comparable to those of biomass combustion processes; however, as the producer gas from fixed bed gasifiers is filtered thoroughly before it is fed into the IC-engine, the standard emissions are CO, NO_x and UHC. From a stable operation of a demonstration plant utilising a two-stage gasifier at DTU, the below emissions have been measured [10]:

CO (mg/Nm ³ at 5% O ₂)	970.0
NO _x (mg/Nm ³ at 5% O ₂)	1197.0
UHC (mg/Nm ³ at 5% O ₂)	21.4

Table 0-1: Example of emissions from a plant with a two stage down draft gasifier.

This performance does not comply with the current emission regulations in Denmark. A possible commercial plant would apply primary or secondary emission reducing measures to comply with regulations.

Dependent on technology, trace metals, especially cadmium contained in the biomass, may be entrained with the gas or end up in the ash from the biomass gasifier. Further, the ash may contain polycyclic aromatic hydrocarbons (PAHs). Therefore, spreading of ash in forests or on agricultural land must be carried out with considerable caution. It has been demonstrated that in some cases thermal gasification may as a side effect entail the possibility to extract trace metals. In Denmark utilisation of the ash is regulated by a ministerial order for biomass ash.

No emission data is stated in the data sheets below, as the specific utilisation of the producer gas is not covered by this technology data sheet.

Research and development perspectives

Updraft:

Up-draft gasification technology with CHP has been demonstrated over a long time in Denmark and abroad.

R&D is carried out, aiming at solving operational problems such as corrosion, process regulation etc. The main issues to be addressed include:

- Ability to handle a wider range of fuel properties, in particular waste wood and other biomass residues
- Establishing references of up-draft gasification plants for waste wood and other biomass residues to drive the incremental development
- Establishing updraft demonstration plants with oxygen and steam as gasification agent to be able to produce bio-SNG.

Other issues that should be addressed to support small-scale biomass gasification:

- Purification of wastewater containing tar; in particular capital cost reduction
- Meeting emissions regulations
- Reactor calculations; kinetic models of significance for design and control

Downdraft:

There exist a number of suppliers of smaller down draft gasifier plants for CHP, ranging from 10 kW_e to 2 MW_e, and as such the technology seems to have reached a level where it enters technological maturity [15]

Research and development activities seem to focus on incremental operation and design optimisations, including better process regulation and automation for unmanned operation, scaling up, and improving gas engine operation with gasification gas.

Examples of market standard technology

Updraft:

At Harboøre Fjernvarme a 3.6 MJ/s updraft counter-current moving bed gasifier was installed in 1994. The gasifier is used for CHP production and has a gross electrical output of 1.0 MW. The gasifier is fuelled by wet forest woodchips. The gasifier is supplied and operated by Babcock & Wilcox Vølund A/S. [2]

Downdraft:

Biosynergi Proces had installed a 300 kW_e and 750 kJ/s heat CHP demonstration plant at Hillerød district heating company. The plant came online in 2016. The concept is designed supply a clean gas on basis of wet forest wood chips that are dried on site as an integral part of the process. Output heat is used for district heating. The process is an “Open Core” downdraft and is a successor and upscaling of the Græsted pilot project (450 kJ/s fuel). [2], [5]. The plant has been dismantled by the end of 2017 due to lack of financing to solve minor technical start-up problems.

In Innsbruck, Austria, SynCraft has installed a 260 kW_e and 600 kJ/s heat CHP plant at the municipal water treatment company, IKW. The plant is a staged downdraft type with an innovative floating fixed bed char gasifier vessel and came online in 2017. The plant used wet wood chips that is dried on site. Output heat is used for district heating.

A number of suppliers and projects outside Denmark are mentioned in [2] and in [30].

Prediction of performance and costs

Small scale gasification plants for CHP production based on biomass are offered by many suppliers worldwide on a commercial basis [2]. However, commercial deployment is for larger plants still moderate and the technology can be characterized as being in a transition between demonstration and commercial maturity (Category 3).

Further development potentials exist, for example for using new fuels types, technical optimizations, upscaling and better control of un-manned installations. Many suppliers tailor their equipment to certain fuels and needs and offer turnkey solutions. A larger commercial deployment may lead to incremental price reductions [2].

The projection of investment cost assumes that the accumulated production capacity will increase by 40 % between 2015 and 2020, double between 2020 and 2030 and further double between 2030 and 2050. Applying a typical learning curve progress rate of 90 % this yields a 5 % decrease in investment costs between 2015 and 2020, a further 10 % reduction between 2020 and 2030 and additional 10 % reduction between 2030 and 2050. It should be stressed that this projection is associated with considerable level of uncertainty. The statistical data on existing plants is very limited, impairing more detailed analyses. O&M costs are assumed to follow the same trend as investments costs.

Due to the limited possibilities for upscaling it is not expected that applying fixed bed gasifiers to production of bio-SNG or other synthetic fuels will be commercially interesting. This would require small to medium scale oxygen production and methanation to reach commercial level. In that case, small to medium scale gasification combined with biogas production for bio-SNG production could become an attractive solution.

Uncertainty

Even though several plants have been in successful operation for several years the uncertainty regarding price and performance for future developments remains considerable. The data assumes considerable learning curve effects. However, there is a widespread number of different principles and variants of the technology, of which many are pioneer projects, and it is not clear which improvements can be realized, and how far.

Additional remarks

Today, fixed bed gasifiers are usually integrated with an internal combustion engine gen-set. Besides the described fixed bed gasifiers, a number of suppliers offer CHP technologies based on bubbling fluid bed gasifiers in the 1-2 MW_e range, e.g. the Spanish Eqtec. [2].

References

Please refer to paragraph in chapter 85 for common references for chapter 83, 84 and 85.

Data sheets

The capacity of the plant is stated as the lower calorific value of the input biomass (MW_{th}), and the output efficiencies refers to the lower calorific value of the producer gas and heat.

Technology	Gasifier, biomass, producer gas, small - medium scale									
	2015	2020	2030	2050	Uncertainty (2020)		Uncertainty (2050)		Note	Ref.
Energy/technical data					Lower	Upper	Lower	Upper		
Typical fuel input capacity, one unit (MW_{th})	20	20	20	20					A	1,2,8
- Input										
Biomass (% of input capacity)	98	98	98	98						
Electricity (% of input capacity)	2	2	2	2						
- Output										
Producer gas (% of fuel input)	74	75	77	83	60	80	80	90	C	3,4,5,8,11
Heat (% of input)	10	10	9	5					B	3,4,5,8,11
Unplanned outage (%)	5	5	5	5						1,2,8
Planned outage (weeks per year)	3	3	3	3						1,2,8
Technical lifetime (years)	20	20	20	20						1,2,8
Construction time (years)	1.5	1.5	1.5	1.5						1,2,8
Financial data										
Specific investment ($M€/MW_{th}$)	1,4	1,3	1,2	1,1	0,9	1,8	0,7	1,4	D	1,3,4,5
- of which equipment	-									
- of which installation	-									
Fixed O&M ($€/MW_{th}/year$)	21.000	20.000	18.000	16.200	15.000	24.900	12.100	20.200	D	1,3,4,5
Variable O&M ($€/MWh_{th}$)	2,6	2,5	2,2	2,0	1,7	3,3	1,4	2,7	D	1,3,4,5
Technology specific data										
Minimum load (% of full load)	20	20	20	20						8

Notes:

- A The stated capacity is the upper range, down scaling is possible.
- B With flue gas condensation, considering lower heating value of biomass fuel.
- C Producer gas primarily consists of the components N_2 , H_2 , CO , CO_2 , CH_4 , and water. Calorific value 5 - 6 MJ/Nm³. For some references ([3], [4]) the electric efficiency has been used to calculate gasifier efficiencies, assuming an engine efficiency of 42%.
- D Fixed bed gasifiers are usually integrated with an internal combustion gas engine gen-set. Sources are for total project including gas engine and the engine part has been deducted at 1.33 M€/Mwe and 42% efficiency. It is assumed that the accumulated production capacity will increase by 40 % between 2015 and 2020, double between 2020 and 2030 and between 2030 and 2050. A learning curve progress rate of 90 % is assumed this yields a 5 % decrease in investment costs between 2015 and 2020, 10 % reduction between 2020 and 2030 and between 2030 and 2050. Similar progress ratios have been used for O&M costs.
- E The values in [9] have been used (sh. 85) but adjusted to keep overall yearly O&M costs at 3% of investment
- F The values in [9] have been used. Variable O&M for a Staged down draft gasifier (sh. 85) have been subtracted O&M of a gas engine (sh. 06).
- G Efficiencies are expected to improve gradually from presently demonstrated levels, to cold gas efficiencies of 85% in 2050. It is assumed that a total efficiency of 90% can be obtained in 2050.

84 Biomass gasification for bio-SNG

Contact Information

- Danish Energy Agency: Jacob Hjerrild Zeuthen, jhz@ens.dk and Filip Gamborg, fgb@ens.dk
- Author: Ea Energy Analyses, Malthe Jacobsen, Morten Tony Hansen
- Reviewer:

Publication date

March 2017

Amendments after publication date

Date	Ref.	Description
-	-	-
-	-	-

Qualitative description

Brief technology description

Biomass can be converted to synthetic natural gas (SNG) by gasification followed by upgrading.

After gasification, upgrading can be done by gas cleaning, CO₂ removal, drying, and methanation of the syngas, to reach a methane content of approx. 95-98%, as required for compatibility with gas in the natural gas grid.

Methanation processes can take place catalytically by conversion of syngas to methane and water. Since the methanation process produces heat it is most often an advantage to integrate the gasification and methanation processes in one plant. The methanation process can also take place by biological processes. The methanation process itself can theoretically reach an efficiency of 80%, the rest converted to heat [21], however the raw gas may contain 5-15% methane already [15]. Therefore, the highest efficiency can be obtained by starting with a gasification process that directly outputs a relatively high share of methane, which is obtained by gasification at moderate temperatures.

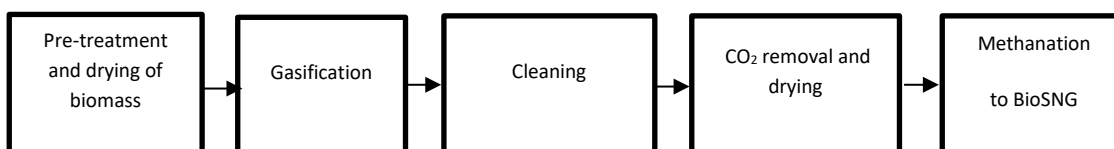

Pre-treatment and gasification

The gasification can take place by different principles using both indirect and direct gasification but aiming at a producer gas without nitrogen and a high proportion of methane which reduces the proportion of gas that needs to be methanised.

Fluidised bed gasification may offer these possibilities as they do not show some of the operational limitations seen with fixed bed gasifiers. As such, fluidised beds may be more compact and

- have an ability to handle fuels with a high ash content and high particle size distribution as well as low bulk density
- prevent bridging, channels and hot spots in the fuel layer
- provide easier scaling up possibilities

Fluidisation is a unit operation by which solid particles through contact with a gas behave as a fluid. The bed in such a reactor may consist of more or less inert solid particles (sand) that become fluidised when a gas, such as ambient air or another agent is blown through the bed. The particles entrain possible fuel particles and the fluidisation enables efficient heat exchange between fuel, sand and

fluidisation gas. Due to the fluidisation, the various steps of the gasification process (drying, pyrolysis, oxidation, reduction) that are quite separated in fixed bed gasification, are mixed in a fluidised bed reactor. This enables a uniform temperature distribution and control opportunities and thus control over the process and output. Drawbacks compared to fixed bed conversion comprise a lower carbon conversion ratio (with unburnt fuel in the ash).

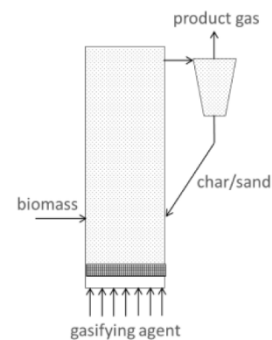

CFB biomass gasifier, principle [8]

Usually, a pre-treatment of the feedstock is necessary including drying, for which excess process heat can be used.

One typical design with indirect gasification uses a dual circulation fluidised bed reactor as shown below, where fast circulating bed material (for instance sand, limestone or olivine) is heated in an air blown reactor by conventional combustion and subsequently returns its heat to the gasification process in the other reactor, where the pre-dried biomass is fed in and which is typically blown by steam. The combustion is primarily fed by the char residues of the biomass feed stock that circulates to the combustor. The gasification can take place at relatively low temperatures (around 800°C) which outputs a gas with relatively high methane content which is relevant for the subsequent methanation process. Further, the low temperature prevents the ash from melting and form corrosive slag.

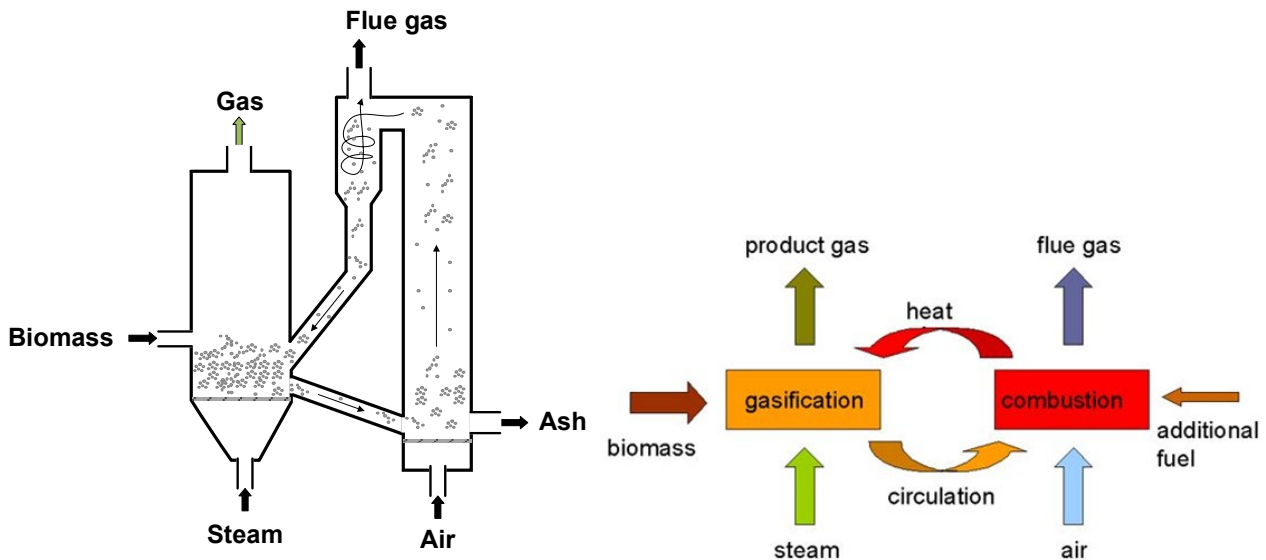

The dual CFB (circulating fluidised bed) process (Güssing type design) [14]

An alternative typical process design uses direct gasification with a pressurised CFB (circulating fluid bed) reactor blown by oxygen and steam and reaches performance data comparable with the indirect dual CFB type [14], [15].

Oxygen for the direct gasification may be produced by air separation (ASU) powered by electricity generated from process excess heat. This may account for 4% of output energy [14]. Alternatively, oxygen obtained as a by-product of electrolysis in future hydrogen generation plants could be used.

Both the direct gasification and the oxygen blown gasifier process types are able to use wood as feedstock material and can (expected) be upscaled to reach an output in the range 200 MW bio-SNG. There are as well other variants of the circulating fluid bed technology intended for, or possibly useful for bio-SNG production.

A bio-SNG plant may utilise some of the high temperature energy streams to generate electricity [16], [21]. However, the electricity production is not significant, and is for future plants assumed to outbalance the electricity demand for internal processes.

Further description of projects, processes, and technologies can be found in [14], [15] and [2].

Gas cleaning

Tar removal is necessary due to the relatively low gasification temperatures. Several options exist, including scrubbing with water or oil, catalytic or thermal cracking.

In addition, sour gases (primarily H₂S) and CO₂ need to be removed by chemical and/or physical absorption, and the syngas composition may be adjusted by a partial shift for obtaining the required ratio of H₂ to CO as suitable for the methanation process.

Methanation

There exist several different process-designs for catalytic methanation of syngas, many of which have been demonstrated in full scale or as pilot plants. [15] [20].

Further, it is possible to convert the excess CO₂ gasses to methane by adding hydrogen gas to the process. This optional process step is not included in this technology sheet.

Input

- Solid biomass such as wood chips, pellets, and agricultural waste products. "
- Auxiliary electricity (may be generated by internal processes)

Requirements to moisture content and size of the fuel depend on the design of the reactor and the process. Fuel with high water content is usually dried prior to gasification in a CFB gasifier. In addition, many demonstration projects have aimed at using waste fractions as a feedstock for gasification [15].

Output

- The output is bio-SNG
- Further output is low temperature process heat, which is assumed valid for district heating
- The main waste product output is ash.

Energy balance

The overall efficiency from solid fuel to bio-SNG ranges between 50-60% in present demonstration projects, and theoretically could be above 80% [8]. By integration of the gasification and methanation processes and by use of excess heat to district heating and, possibly, electricity production to cover internal electricity demand, the overall efficiency can be high, likely up to 90%. [3], [16], [21].

In the GoBiGas 20 MW demonstration project, the following efficiencies were measured and reported, though not accounting for an electricity demand of some 3 MW and bio-oil demand of 0.5 MW [21]:

Fuel to cold gas efficiency (syngas): 76.5%

Fuel to methane efficiency: 62.7%

Total efficiency, fuel to methane and heat: 85.4%

These numbers refer to the plant fuelled with wood pellets, and the results cannot directly be transferred to fuels with higher water content, though.

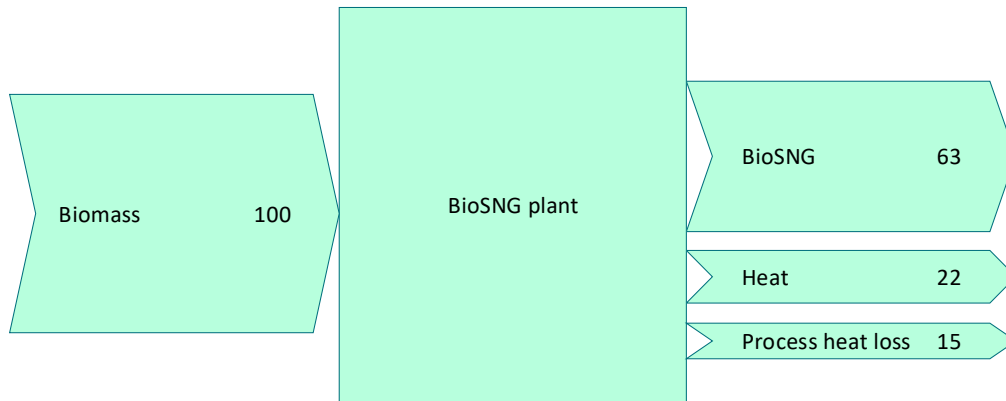

Sankey diagram of Bio-SNG gasifier plant in 2030.

Typical capacities

The capacity of current (2016) demonstration plants is in the range 20 MW_{gas}.

With a further technical development and the necessary investments, it is expected that the commercial plant size will be up to 200 MW_{gas} by 2020.

Regulation ability

The CFB gasification and associated methanation process plants generally have limited regulation and part load capabilities, depending on the process types though. It is assumed that plants are in continuous operation for 8,000 hours per year.

Space requirement

The main space requirements typically relate to the storage, handling, and possibly drying of biomass feedstock, which can be assumed to correspond to what is required for biomass power plants.

Advantages/disadvantages

A major advantage of bio-SNG generation is the possibility to use existing natural gas infra structure for transport and storage of biomass-based energy in a form, which can be utilized for multiple purposes.

Compared with fixed bed gasification technologies, the CFB technologies with methanation are more technically complex process plants, which in turn can reach higher efficiencies and are more suitable for upscaling. This requires, however, an infrastructure for biomass procurement, handling, and storage. A substantial heat demand from e.g. district heating systems is an advantage to reach high overall efficiencies.

The CFB gasification processes are typically relatively robust with regard to feedstock quality and can use much larger particle sizes than e.g. entrained flow gasifiers.

The relatively low temperatures of CFB gasification makes it possible to recycle the ash to forests and agricultural land, however tar content and concentration of certain heavy metals such as cadmium may be an environmental problem.

The direct, oxygen blown, CFB technologies may have an advantage over the indirect due to higher throughputs, leading to smaller relative investments, and higher methane rates.

Environment

Generally, the environmental aspects of biomass gasification are comparable to those of biomass combustion processes in general. Depending on the further processes involved in a specific plant, waste products might include condensation waste water, ash with used bed material, used catalytic material, and other waste from chemical reactors etc.

In the case of the pilot plant GoBiGas phase I, [22] mentions annual emissions of 15 tonnes of NO_x and 3.5 tonnes of sulphur as well as a small amount of methane from the methanation process. This must, however, be planning data as the plant was not yet commissioned in 2012. The environmental report from operations in 2015 [23] mentions an emission of 2,933 kg NO_x, 2,997 kg S as well as 1,516 kg NH₃ and 65 kg N₂O from production of 30,000 MWh of biomethane. This corresponds to an average emission of 0.1 kg NO_x, 0.1 kg S, 0.05 kg NH₃ and 0.002 kg N₂O per MWh gas produced.

[23] also mentions a number of waste streams containing harmful components such as ash, water-based streams with chemicals, active coal etc.

Research and development perspectives

Process integration and optimisations, including energy optimisations in the integration of gasification, gas treatment and methanation processes. This includes the handling and reforming of tars and preservation of methane from gasification. A specific area of R&D is the methanation process, where several proprietary technologies seem to compete [15]. Experiences from pilot and demonstration plants are expected to lead

to further innovation and development that will allow upscaling. It is also expected that such optimisations can eventually lead to improved gas efficiencies compared to present technology [8].

The treatment of biomass fuels is another area for further development, as large quantities of wood and other material shall be transported, handled, stored and dried.

Examples of market standard technology

Indirect, dual CFB:

Valmet is a major supplier of CFB gasification plants in the range 100-200 MW for both combustion in power plants, and also for the GoBiGas demonstration bio-SNG plant.

<http://www.valmet.com/products/energy-production/gasification/>

GoBiGas is a 20 MW_{gas} technical demonstration project in Göteborg, Sweden, aiming at 65% conversion efficiency, 90% overall efficiency. The plant is fueled by wood pellets and has experienced campaigns of continuous operation since December 2014. [2]. The pilot plant has been retrofitted for wood chips and is in summer 2016 being recommissioned on wood chips. An informative film about the concept can be viewed at <http://goteborgenergi.streamingbolaget.se/video/156153/link>

Direct BFB:

Another major supplier of CFB biomass technology is the company Andritz Carbona which has supplied the bubbling fluidized bed gasifier to the Skive plant in Denmark, commissioned in 2009.

<https://www.andritz.com/products-en/group/environmental-solutions/power-generation/gasification>

Direct, oxygen blown CFB:

Amec Foster Wheeler's "bio-SNG proof-of-concept" for a 12 MW_{th} oxygen/steam blown pressurized (4 bar) CFB plant in Varkaus, Finland [2], [15].

Prediction of performance and costs

As of today, the integrated biomass CFB gasification and methanation technologies are in a pioneer phase (Category 2), and the uncertainty regarding future performance and price data is high. Data for 2015 and 2020 are mainly based on demonstration projects.

Assumptions for the period 2020 to 2050

It is assumed that the present demonstration scale plants using CFB and methanation in the capacity range 10-20 MW_{th} will eventually be scaled up and can reach commercial maturity in year 2030 with a capacity in the range of 200 MW gas output. Even though the potential scaling and learning curve effects appear to be

significant the estimated future values are widely based on scientific studies of process optimizations, and on industry expectations, and it is not obvious that such development will take place.

The required technical development seems feasible since some of the major elements are already widely used, such as catalytic methanation in SNG production based on fossil fuels. Furthermore, the R&D activities involve actively both universities as well as private companies and large energy companies. However, a development of large scale biomass SNG technology will also require the necessary commercial drivers to be present. It is expected that the investments to ensure a further development shall be mainly made by large companies, involved in the energy sector.

Therefore, for development to take place, such investments will have to be evaluated as being overall commercially attractive, at least in the long term, taking the expected future price levels of competing fuels (natural gas and when focusing on the transport sector also of oil) as well as possible subsidies and CO₂ emission costs into account. The data for 2020 – 2050 assumes that such market demand will be present, and that investment costs can be reduced by considerable upscaling and learning curve effects.

Uncertainty

The long-term development of the technology is by nature uncertain, due to the current development stage (Pioneering phase) and the fact that positive results of larger scale deployment are not yet demonstrated. The figures in the data sheets assumes an optimistic scenario in which the described upscaling and learning curve effects will take place and therefore the uncertainty is high.

Additional remarks

Fluidized bed gasifiers may be used for a variety of purposes and can be seen in connection with small to medium scale CHP plants, larger scale co-firing plants CHP plants, bio-SNG facilities as well as biofuel facilities.

References

Please refer to paragraph in chapter 85 for common references for chapter 83, 84 and 85.

Data sheets

The capacity of the plant is stated as the lower calorific value of the input biomass (MJ/s), and the output efficiencies refers to the lower calorific value of the bio-SNG and heat.

Technology	CFB (Circulating fluid bed) gasifiers, biomass, bio-SNG, medium - large scale									
	2015	2020	2030	2050	Uncertainty (2020)		Uncertainty (2050)		Note	Ref
Energy/technical data					Lower	Upper	Lower	Upper		
Typical fuel input capacity, one unit (MW _{th})	32	154	400	400						12;13
- Input									B	
Biomass (% of input capacity)	91	100	100	100						
Electricity (% of input capacity)	9	0	0	0					B	
- Output									B	
Bio SNG (% of fuel input)	56	60	63	70	58	65	65	75	G	21;19;13/17/19;
Heat (% of input)	15	20	22	20					H	21;19;13/17/19;
Unplanned outage (%)	3	3	3	3						
Planned outage (weeks per year)	3	3	3	3						
Technical lifetime (years)	15	20	20	20						
Construction time (years)	2,5	2,5	2,5	2,5						
Financial data										
Specific investment (M€/MW _{th})	4,0	2,5	1,6	1,5	1,8	3,0	1,4	2,6	E	12+21;12+19+13;15/17
- of which equipment	-									
- of which installation	-									
Fixed O&M (€/MW _{th} /year)	80.450	40.220	26.220	24.130	30.170	50.280	18.100	30.160	F	12/21;12/21+13/17/19
Variable O&M (€/MW _{th})	5,3	2,7	1,7	1,6	1,8	3,5	1,1	2,1	F	12/21;12/21+13/17/19
Technology specific data										
Warm start-up time (hours)	6	6	6	6					C	
Cold start-up time (hours)	12	12	12	12					C	
Environment										
NO _x (g per GJ fuel)	16	20	20	20					D	23, 29
CH ₄ (g per GJ fuel)	0	0	0	0					D	29
N ₂ O (g per GJ fuel)	0,3	1	1	0					D	23, 29

Notes:

- A With flue gas condensation
- B Generally the plants' electricity generation is assumed to balance the consumption
- C Assumed to be in the same magnitude as a coal fired power plant
- D 2015 data for NOX and N2O origin from [23]. Other values are assumed to be in the same magnitude as a biomass fired PF power plant (pellets)
- E For 2015, values reflect the 20 MWgas Swedish GoBiGas Phase 1 demonstration project. A proportionality factor of 0.7 is assumed to apply when going from 2015 to 2020 based on the anticipated upscaling from 20 MWgas to 100 MWgas [21]. For 2030, the figure is an average of a value from theoretical studies [17] multiplied by 1.4 and a value from feasibility studies [19] multiplied by 1.15. From 2030 to 2050 simply a reduction of 10% has been assumed to reflect a learning curve.
- F Assumed that the total O&M costs splits in 1/3 variable, 2/3 fixed costs, 8000 h/year
- G Efficiencies are expected to improve gradually from presently demonstrated level, to values corresponding to various studies for large plants in 2030, and gradual increase to 2050. It is assumed that a total efficiency of 90% can be obtained.
- H Heat at normal district heating temperature set 80/50 deg. Additional low temperature heat for heat pumps is possible. For uncertainty values, a higher heat output can be expected at low gas output and vice versa.

85 Liquid fuels from biomass gasification and Fischer Tropsch

Contact Information:

Danish Energy Agency: Jacob Hjerrild Zeuthen, jhz@ens.dk and Filip Gamborg, fgb@ens.dk

Author: Don O'Connor – (S&T)² Consultants Inc.

Publication date

August 2018

Amendments after publication date

Date	Ref.	Description
02 2019	Chapter 85+96	The two chapters 85 and 96 on bio fuels from gasification + Fischer Tropsch have been merged to one chapter that is now Chapter 85.
12 2018		Datasheet revised

Qualitative Description

The production of diesel or jet fuel from biomass is a two-step process, in the first step the solid biomass is converted to the gas phase and in the second step the gas is converted to liquid fuels.

Gasification is a process that converts organic or fossil-based carbonaceous materials at high temperatures (>700°C), without combustion, with a controlled amount of oxygen and/or steam into carbon monoxide, hydrogen, and carbon dioxide (syngas). The carbon monoxide then reacts with water to form carbon dioxide and more hydrogen via a water-gas shift reaction.

The Fischer–Tropsch process (or Fischer–Tropsch Synthesis or F-T) is a set of chemical reactions that changes a mixture of carbon monoxide gas and hydrogen gas into liquid hydrocarbons. These reactions occur in the presence of certain metal catalysts, typically at temperatures of 150–300 °C and pressures of one to several tens of atmospheres.

Brief Technology Description

The biomass could be agricultural or forestry residues. There is a wide range in the design of gasifiers used for biomass. Different technological solutions can be implemented in order to obtain different plant configurations; in particular, the mode of contact of the biomass with the gasification agent may be in counter-current, or co-current, or crossflow, and the heat can be transferred from the outside or directly in the reactor using a combustion agent; the residence time can be in the order of hours (static gasifiers, rotary kiln) or minutes (fluidized bed gasifiers). Different gasifier designs are better suited to different feedstocks and gas needs. Gasification is further described in Biomass Gasification - general introduction and the following chapters. The Fisher Tropsch reactions are practised commercially on syngas produced from coal (Sasol) and on natural gas (Shell, Chevron, Sasol, and others).

The overall process is shown in the following simplified process flow diagram.

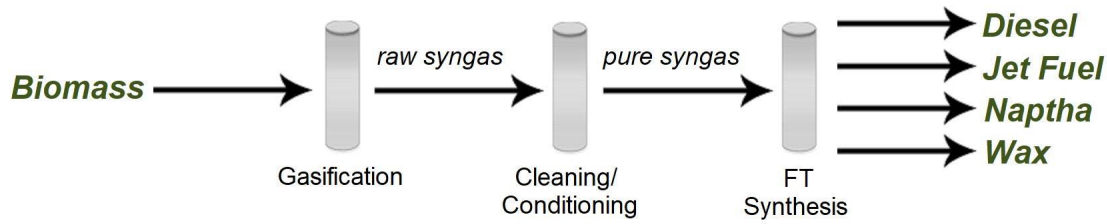

Figure 1 Biomass to Diesel and Jet Process

Input

The primary input for most process is just the biomass. The reactions are exothermic and generate enough heat for the process and to produce the power required for the system.

Output

The FT synthesis process produces a range of hydrocarbon from light ends to heavy waxes. It is difficult to control the selectivity of the process to produce just diesel fuel or jet fuel. In some commercial facilities the light ends and the heavy wax materials can be recycled through the process to improve the selectivity but usually at the expense of overall efficiency. Some systems will produce excess power for sale from the system.

Energy Balance

The energy balance for a system is shown in the following figure [1]. It is based on NREL’s work on biomass to liquids. The carbon efficiency of the biomass gasifier to raw syngas is 72% and the carbon efficiency of the syngas to fuels is 46% for an overall carbon efficiency of biomass to fuels of 33.2%. The energy out per unit of energy in is 39%.

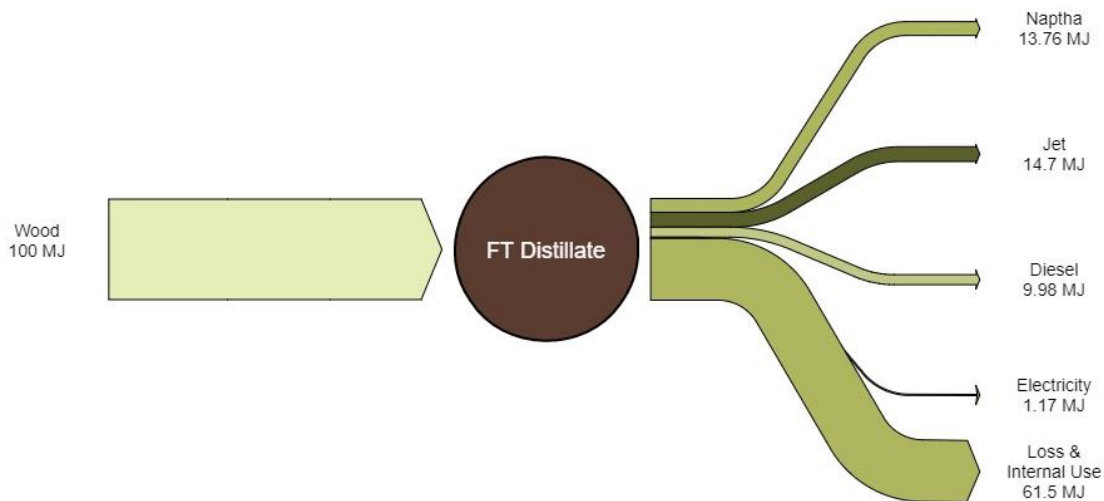

Figure 2 Biomass to Diesel and Jet Energy Balance

The overall energy efficiency of the process is relatively low. There are two potential means to recover some of the waste heat. The plants use some of the process heat to produce electricity for the plant use and potentially a small amount to be exported. Steam from the exit of the final steam turbine would be available

for other uses. This could have a temperature between 150 °C and 185 °C depending on the design. There may also be some opportunity to recover some lower grade heat as the syngas is conditioned prior to synthesis. Details of the potential for energy recovery are not reported in most of the recent techno-economic studies published.

Other computer simulations of biomass to FT systems have reported higher efficiencies. Kreutz et al [2] reported 49 to 50.5% energy efficiency on a LHV basis. They had similar carbon efficiency of the feedstock to the fuels.

Baliban et al [3] modelled several optimized hardwood to FT liquid process configurations. The energy efficiency ranged from 56 to 61% and the carbon conversion efficiency ranges from 54 to 60%.

Sikarwar [4] identified feedstock characteristics that influence the performance of biomass gasification systems. These include moisture content, ash content, chlorine and sulphur, and the cellulose, hemicellulose and lignin fractions as the three components degrade at different temperatures during gasification. He reports that in general, the higher the cellulose and hemicellulose content, the greater the volume of gaseous products formed. Therefore, softwood, hardwood, wheat straw and bagasse with much higher cumulative percentages of cellulose and hemicellulose are preferred over sunflower seed hull, coconut shell, almond shell, larch plant or poultry litter, when attempting to obtain gas as the final product.

Typical Capacities

There are no commercial scale systems in operation. The NREL techno-economic analysis was based on processing 2,000 tonnes of dry wood per day. The plant would produce 175 million litres per year of fuel.

In a review of the state of the art biomass gasification [5], Molino et al reports on the European biomass gasification plants. They identify 22 gasification facilities but only five that has more than 7,000 h/year of operation time. The capacities are in the 10 to 40 MW range with one larger facility that co-fires biomass and fossil fuels. The facilities are identified in the following table.

Site	Thermal Output, GJ/year	Running h/year
Harboøre (Denmark)	576,000	8,000
Gussing (Austria)	230,400	7,000–8,000
Skive (Denmark)	576,000	7,500
Lahti (Finland)	1,152,000	7,000
Buggenum (the Netherlands)	17,280,000	7,500

Table 1 European Biomass Gasification Plants

The commercial FT plants using fossil energy as the input are all much larger than the biomass gasification plants shown in the table above. The largest fossil plant is the 260,000 bbls/day (500 million GJ/year) Shell plant in Qatar. Shell's original GTL plant in Malaysia has a capacity of less than 15,000 bbls/day (30 million GJ/year).

There is work ongoing on small FT distillate reactors. Velocys claims that the commercially optimal size for their biomass to FT liquids system is 1,900 bbl/day (72 million litres/year) [6]. Their reference plant processes landfill gas and produced 200 bbls/day of finished products (375,000 GJ/year).

Regulation Ability

Biomass gasifiers can be operated down to about 35% of the rated capacity depending on the configuration, feedstock moisture contents and the acceptable efficiency loss [7]. However, the gas composition will change over this range and when the gasifier is coupled to a synthesis reactor there is a need for relatively constant feed compositions. The high temperature and pressure of the FT reactor will limit the regulation ability of the overall system.

Space Requirements

The biomass gasification district heating plant in Harboøre is situated on a less than one hectare. The GoBiGas facility in Sweden, which is a biomass gasifier and an SNG facility is on a two hectare site. The original design capacity was 100 MW (3 million GJ/year), although only the first phase of 20 MW was built.

The space requirements will be less than 1,000 m²/MW. This may be reduced if the size of the units are larger.

Advantages/Disadvantages

Biofuels that can be produced from non-feed or food feedstocks and can be used in heavy duty transport applications, which can't be easily electrified, are an attractive option for decarbonizing the transport sector. Drop-in biofuels, such as the FT fuels made by this technology can be used in the existing fuel infrastructure and are attractive to the existing fuel providers.

This technology combines gasification systems that have only been operated at small scale and FT synthesis systems that are commercialized at very large scale. Determining the combined size that will work, technically and economically, for both technologies is a challenge. The techno-economic analyses that have been done on this technology have considered plants in the range of 1,000 to 2,000 dry tonnes of wood per day (350,000 to 700,000 dry tonnes of wood per year).

The Danish Energy Agency reports the following production of woody biomass in 2015 [8].

Type	TJ	Tonnes (dry)
Wood Chips	13,335	701,842
Firewood	21,943	1,154,895
Wood pellets	2,641	139,000
Wood waste	8,837	465,105
Total	46,756	2,460,842

Table 2 Woody Biomass Production and Consumption for Energy

A single woody biomass to diesel and jet fuel plant would require a 15 to 30% increase in the current production and consumption of woody biomass in Denmark.

Environment

The sustainability of the feedstock production is a potential issue with all biomass systems. The overall energy out per unit of energy in the feedstock is relatively low for this technology. Biomass gasification systems will produce some ash that must be disposed of. The wood ash can be used to adjust the pH of soils but the availability of the nutrients in the ash may not always be fully bioavailable. Wood species and gasification type appear to have some influence on the properties [9].

The fuels produced have no sulphur, are low in aromatics and are considered clean burning. Their volumetric energy content is about 10% lower than diesel fuel due to the lower density.

Research and Development Perspective

Biomass gasification for diesel and jet fuel produced from wood or straw is a category 2 technology, a pioneer phase technology with limited applications to date. The technology has been proven to work through demonstration facilities or semi-commercial plants. However, due to the limited application, the price and performance is still attached with high uncertainty, since development and customization is still needed. The technology still has a significant development potential.

Both the gasification and the FT distillate technology have been known and practiced for almost 100 years. They are commercial technologies for other feedstocks.

There is work underway on integrating the two technologies, improving the gas clean-up system performance and addressing the issue of scale for the fuel synthesis stage.

Examples of Market Standard Technology

The technology has not yet been commercialized. In Europe, Repotec, an Austrian company, have been involved with the Gussing gasifier, the GoBiGas SNG project in Sweden, and the Senden wood gasifier to power facility in Germany.

In Denmark, B&W Vølund built the wood gasifier at Harboøre but no other references for the technology were identified.

The UK-American company, Velocys is working on small scale FT plants. They are developing smaller scale microchannel FT technology that was originally developed by the Pacific Northwest National Laboratory in Washington State, USA. Their first project is using landfill gas but they are working with ThermoChem Recovery International of gasification systems for woody biomass that would be coupled with the Velocys FT technology [10]. The system would produce 1,400 bbl/day of FT products. This would require 1,000 tonnes of wood per day.

Velocys is working on a USDA Phase 2 application for a loan guarantee for a wood to FT liquid project [11]. Phase 2 applications include the environmental report, technical report, financial model, and the lender's credit evaluation. The plant is to be built in Natchez, Mississippi on a 40 ha site. The plan is to start construction in late 2018 or early 2019. Velocys are also working on a waste to jet fuels project in the UK with British Airways and other partners but this project is not as well defined as the wood project in the USA.

Velocys plc

Harwell Innovation Centre
173 Curie Avenue, Harwell
OX11 0QG, United Kingdom

Gasifier design: Entrained flow reactor

The entrained flow gasifier technology is well suited for large scale gasification. This specific design is described in this section.

In an entrained flow reactor, the high temperatures and pressure produces a clean syngas with very little methane and tar [18]. This makes the gas well suited for further chemical processing and production of bio-fuels.

The entrained flow reactor has been used for large scale coal gasification for decades but is much less developed and demonstrated for biomass. The fine ground feedstock material which, when coal is used, may be mixed with water to a slurry, is fed from the reactor top together with steam and oxygen. When biomass is used, the input may be pyrolysis oil. Partial combustion and gasification takes place in the pressurised reactor at high temperatures (>1,000°C, up to 1,600°C for coal). Slag and ash are removed from the bottom. A high capacity is possible due to high reactivity at high temperature and pressure. The high combustion temperature results in formation of slag instead of ash as the main residue.

The high outlet gas temperature usually makes the thermal efficiency low, unless the process is integrated with other energy consuming processes. One possibility is to pre-treat solid fuel by torrefaction at 2-300°C, whereby the fuel is easier to pulverise, and the overall efficiency is improved [19]. However, an additional energy loss in the torrefaction process must be expected. As for the CFB gasifier processes, the oxygen necessary may be produced in a process-integrated air separation unit powered by electricity internally produced from excess process heat.

Challenges when moving from coal to solid biomass feedstock comprise obtaining a uniform particle size distribution and feeding biomass into a highly pressurised vessel. Instead of pulverising the fuel, it has been suggested as a pre-treatment to transform it into oil/char slurry through a fast pyrolysis.

Also, ignition and flame stability as well as the alkali content and ash melting behaviour in biomass are challenging issues.

Advantages/disadvantages

Compared to CFB gasifiers, the entrained flow gasifiers can have considerably higher throughput, which together with the high temperatures favours upscaling. Further, the high temperatures produce a clean

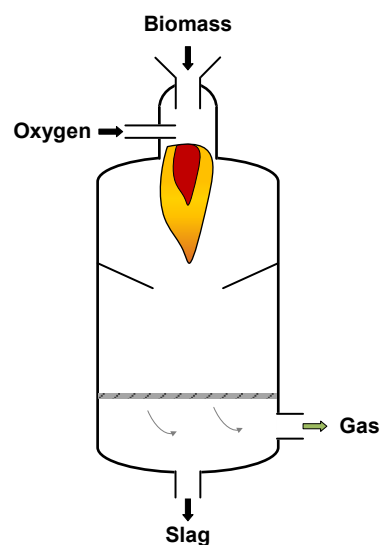

Principle of the entrained flow gasifier.

syngas with no tar and very little methane. The high outlet gas temperatures usually make the thermal efficiency lower, unless integrated with other energy consuming processes.

Entrained flow gasification has an advantage if the available fuel is a liquid that can be spray atomised, like for instance the residues of paper pulp manufacturing. However, for solid fuels like fresh wood, the grinding will use considerable amounts of energy. Pre-treatment by torrefaction or pyrolysis may reduce these costs and reduce feeding challenges into a pressurized system.

The output gas has a lower content of methane than will be possible with CFB gasifiers. This will reduce the fuel-to-methane efficiency. Thus, the entrained flow gasifiers appear to be more suitable for processes where the end-product is not methane, e.g. other synthetic fuels such as Fischer Tropsch diesel, or for direct combustion in gas turbines.

A disadvantage compared with CFB gasifiers is, that the combustion at high temperatures will result in a slag residue which cannot be recycled to the environment. This is particularly relevant for fuels with a high content of ash and nutrients such as straw.

The large plant sizes would require an efficient feed stock sourcing strategy and possibly increase the need for pre-treatment by torrefaction and/or pelletisation or pyrolysis - possibly decentralized - to optimise sourcing.

Predication of Performance and Cost

The prediction of performance and cost is based on published techno-economic papers rather than on actual plant performance. The NREL paper is based on a plant twice the size of the proposed Velocys project.

Uncertainty

There is a high level of uncertainty for the technology given the state of development and the fact that there are no operating plants in the world at this time.

Additional Remarks

One of the challenges for small scale FT plants has been that a range of products is produced, from gasoline boiling range products to waxes. Markets for all products are required for commercial success and finding markets for small volumes of gasoline blending components and the wax can be an issue. In some projects the revenue from the wax has been a significant portion of the total revenue.

FT synthesis produces a range of products between C_1 and waxes. The actual ranges will vary with process type, catalysts, and syngas quality but there is always a range of products. This implies that separation of the relevant fractions will be needed downstream the FT process. Tijm [12] reports on the product distribution for two different process severities as shown in the following table. Unfortunately the paper does not provide the accompanying yield data for the two operating conditions but there is more gasoline produced in the kerosene mode than the diesel mode.

	Gas Oil Mode	Kerosene Mode
--	--------------	---------------

	% wt	
Tops/naphtha	15	25
Kerosene	25	50
Gas Oil	50	25

Table 3 Product Distributions – Shell SMDS

In his 1999 thesis, van der Lann [13] showed that the quantity of each group of products did vary with operation conditions. This is shown in the following figure where the two right hand bars represent the liquid products and the two left hand bars represent the gaseous products. The sum of the two liquid products (and thus the yield) as well as the ratio of heavy to light liquid products does vary with the pretreatment conditions.

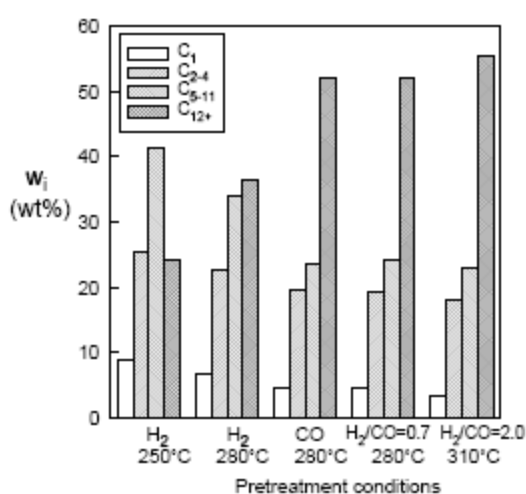

Figure 3 Selectivity vs. Yield

Quantitative Description

The available quantitative data that is available on the technology is mostly from third parties and not from the technology providers or plant operators. Actual plant data is considered confidential by the process developers.

There are three basic reactions that occur in the process. The first reaction breaks the biomass down to a combination of hydrogen, carbon monoxide and carbon dioxide. A simplified reaction is shown below. Actual biomass has highly variable composition and complexity with cellulose as one major component.



Note: The above reaction uses glucose as a surrogate for cellulose.

Stoichiometry for methanol production of syngas requires the ratio of H₂ / CO to equal 2. The product gases are then subjected to the water-gas shift reaction to increase the quantity of hydrogen. The equilibrium for this reaction is temperature dependent which controls the CO to CO₂ ratio.

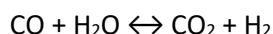

This is then followed by the synthesis reaction as shown below. In this reaction the carbons are added sequentially making it difficult to control the chain lengths of the final products.

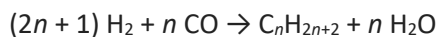

Generally, the Fischer–Tropsch process is operated in the temperature range of 150–300 °C. Higher temperatures lead to faster reactions and higher conversion rates but also tend to favor methane production. For this reason, the temperature is usually maintained at the low to middle part of the range. Increasing the pressure leads to higher conversion rates and also favors formation of long-chained alkanes, both of which are desirable. Typical pressures are up to 30 bar.

Typical Plant Size

The proposed Velocys plant will process 1,000 tpd of wood and produce 79 million litres of product. The NREL techno-economic work assumed a plant size of 2,000 tpd. This is about the wood required for an average pulp mill. New pulp mills are being built larger and can consume up to 10,000 tpd. Plant size will likely be determined by the feedstock availability.

Input and Output

The primary input and output for a wood to FT plant is summarized in the following table [1]. There are some chemicals and catalysts required but the quantities are very small.

Parameter	Input	Output
Wood	4.06 kg	
Wood	76 MJ	
Naphtha		0.36 litre
Jet		0.38 litre
Diesel		0.26 litre
Power		0.26 kWh

Table 4 Inputs and Outputs

Forced and Planned Outage

The plants are expected to operate for 350 days per year. Wood gasifiers are capable of operating at these rates as shown earlier and fossil FT plants are also capable of operating at these rates. Forced outages are expected to be minimal.

Technical Lifetime

Due to the maturity of the technology, plant lifetime is estimated to be 20 years for plants build before 2025. Hereafter, it is expected to grow to 25 years.

Construction Time

Construction time for the technology is expected to be about 24 months.

Financial Data

The financial data is only available from the literature. There is a preliminary cost estimate of \$300 million for the 72 million litre Velocys plant in Mississippi (80 MW) [14]. This would be €4.25/litre for a European plant.

Investment Costs

Tan et al project that the total capital investment for the plant is \$650 million for the 180 million litre plant. The cost basis is 2011. Converting this to 2015 Euros the cost would be 716 million Euro, or €4.0/litre of product.

Irena [15] report current capital costs for this pathway as \$3,000 to \$5,000/kW (€2.8 to €4.6/litre). The EU Sub Group on Advanced Biofuels [16] report the capital costs as €3,000/kW (€3.35/litre).

Considering the capital growth factor information from de Jong [17] the capital cost information for the nth plant from Tan and the Velocys pioneering plant is too close together. It is likely that the pioneering cost estimate is too low, we have increased it to €5.00/litre, which may still be too optimistic

Operating and Maintenance Costs

The Tan et al estimates of fixed and variable operating costs, excluding feedstock are shown in the following table. These costs are much less than the feedstock costs and the capital related costs in the analysis.

Parameter	Euro/litre
Variable operating costs, ex feedstock	0.01
Fixed costs	0.12

Table 5 Operating and Maintenance Costs

Start-up Costs

The start-up costs are included in the costs shown above.

Technology Specific Data

The typical properties of FT diesel are compared to petroleum diesel in the following table. The fuel has a higher cetane than petroleum diesel but a lower volumetric energy content. Due to the low content of aromatics the gasoline produced from FT naphtha will have a low octane number.

	Petroleum Diesel	FT Diesel
Density, kg/litre	0.84	0.77
Energy content, MJ/litre	36.0	33.9
Energy content, MJ/kg	42.8	44.0
Cetane	48	~70

Table 6 Typical Fuel Properties

Data sheet

The quantitative data for the biomass to diesel and jet process are summarized in the following table.

Technology	Gasifier, biomass, Fischer Tropsch liquid fuels, large scale										
	2015	2020	2030	2040	2050	Uncertainty (2020)		Uncertainty (2050)		Note	Ref
						Lower	Upper	Lower	Upper		
Energy/technical data											
Typical total plant size 1,000 t FT Liquids/year	50	50	100	125	150	100%	150%	50%	150%	A, B	1, 6
Typical total plant size, MW	75	75	150	190	225	100%	150%	50%	150%	A, A1, B	1, 6
Inputs											
Feedstock Consumption, MWh/MWh Total Input	1	1	1	1	1	80%	100%	80%	100%	C	1
Outputs											
Naphtha Output, MWh/MWh Total Input	0.138	0.138	0.145	0.154	0.163	80%	110%	80%	110%	D	1
Jet Fuel Output, MWh/MWh Total Input	0.015	0.015	0.015	0.016	0.017	80%	110%	80%	110%	D	1
Diesel Output, MWh/MWh Total Input	0.100	0.100	0.105	0.112	0.118	80%	110%	80%	110%	D	1
Electricity Output, MWh/MWh Total Input	0.012	0.012	0.016	0.018	0.020	80%	110%	80%	110%	D	1
Operational data											
Forced outage (%)	4	4	0	0	0						
Planned outage (weeks per year)	2	2	2	2	2						
Technical lifetime (years)	20	25	25	25	25						
Construction time (years)	2	2	2	2	2						
Financial data											
Specific investment (M€ /MW Liquids/year)	4.33	4.33	3.90	3.62	3.46	75%	120%	75%	120%	E, L	1, 6, 7, 8, 9
- equipment (%)	75	75	75	75	75						
-installation (%)	25	25	25	25	25						
Fixed O&M (M€ /MW /year FT Liquids/year)	0.104	0.104	0.104	0.103	0.104	75%	120%	75%	120%	L	1
Variable O&M (€ /MWh FT Liquids/year)	1.063	1.063	1.063	1.064	1.063	75%	120%	75%	120%	L	1
Start up (M€ /1,000 t FT Liquids/year)	0	0	0	0	0					F	
Technology specific data											
Specific energy content (GJ/ton) FT Diesel)	44	44	44	44	44						
Specific density (kg/l) or (ton/m ³)	0.77	0.77	0.77	0.77	0.77						
Specific investment (M€ /1,000 t FT Liquids/year)	6.49	6.49	5.84	5.50	5.19	75%	120%	75%	120%	E, L	1, 6, 7, 8, 9
- equipment (%)	75	75	75	75	75						
-installation (%)	25	25	25	25	25						
Fixed O&M (M€ /1,000 t FT Liquids/year)	0.156	0.156	0.156	0.156	0.156	75%	120%	75%	120%	L	1
Variable O&M (M€ /1,000 t FT Liquids/year)	0.013	0.013	0.013	0.013	0.013	75%	120%	75%	120%	L	1
Start up (M€ /1,000 t FT Liquids/year)	0	0	0	0	0					F	

Notes:

- A. The plant size is assumed based on the proposed Velocys plant and the NREL nth plant.
- A1. This value is the hourly rating and has been calculated as if the unit produces at capacity and was in operations 8,000 h/year
- B. Feedstock availability is likely to determine the maximum plant size.
- C. The feedstock requirements could vary with efforts to improve the desired product selectivity.
- D. Over time the power available for export may increase due to improve thermal management in the plant.
- E. There is a wide range of reported capital costs for the existing plants and a wide range in the cost of future plants.
- F. Start-up costs are included in the operating costs.
- G. M €/k tonne is million euro per 1,000 tonnes

References

- [1] Tan, E. C. D., Snowden-Swan, L. J., Talmadge, M., Dutta, A., Jones, S., Ramasamy, K. K., Gray, M., Dagle, R., Padmaperuma, A., Gerber, M., Sahir, A. H., Tao, L. and Zhang, Y. 2017. Comparative techno-economic analysis and process design for indirect liquefaction pathways to distillate-range fuels via biomass-derived oxygenated intermediates upgrading. *Biofuels, Bioprod. Bioref.*, 11: 41–66. <https://www.doi.org/10.1002/bbb.1710>
- [2] Kreutz, T., Larson, E., Liu, G., Williams, R. 2008. Fischer-Tropsch Fuels from Coal and Biomass. 25th Annual International Pittsburgh Coal Conference. <http://acee.princeton.edu/wp-content/uploads/2016/10/Kreutz-et-al-PCC-2008-10-7-08.pdf>
- [3] Baliban, R., Elia, J., Floudas, C., Gurau, B., Weingarten, M., and Klotz, S. 2013. Hardwood Biomass to Gasoline, Diesel, and Jet Fuel: 1. Process Synthesis and Global Optimization of a Thermochemical Refinery. *Energy & Fuels* 2013 27 (8), 4302-4324. <https://www.doi.org/10.1021/ef302003f>
- [4] Sikarwar, V., Zhao, M., Clough, P., Yao, J., Zhong, X., Memon, Shah, M., Anthony, E., and Fennell, P. 2016. An overview of advances in biomass gasification. *Energy Environ. Sci.* 2016, 9, 2939. <https://doi.org/10.1039/C6EE00935B>
- [5] Molino, A., Chianese, S., Musmarra, D. 2016. Biomass gasification technology: The state of the art overview, In *Journal of Energy Chemistry*, Volume 25, Issue 1, 2016, Pages 10-25, ISSN 2095-4956, <https://doi.org/10.1016/j.jechem.2015.11.005>
- [6] Velocys. 2017. The biomass-to-liquids process. <http://www.velocys.com/our-biorefineries/>
- [7] Chandra, P.K. & Payne, Fred. 1986. Turndown Ratio of a Gasifier-Combustor Predicted by a Simulation Model. *Transactions of the ASAE*. 29. 1748-1753. <https://doi.org/10.13031/2013.30383>.
- [8] Danish Energy Agency. 2017. Energy Statistics 2015. https://ens.dk/sites/ens.dk/files/Statistik/energy_statistics_2015.pdf
- [9] Li X, Rubæk GH, Müller-Stöver DS, Thomsen TP, Ahrenfeldt J and Sørensen P. 2017. Plant Availability of Phosphorus in Five Gasification Biochars. *Front. Sustain. Food Syst.* 1:2. <https://www.doi.org/10.3389/fsufs.2017.00002>
- [10] Velocys. 2017. Establishment of a strategic alliance with TRI. <http://www.velocys.com/establishment-of-a-strategic-alliance-with-tri/>

- [11] Velocys. 2017. Velocys plans for the construction of a commercial BTL plant move forward. <https://biorrefineria.blogspot.ca/2017/06/velocys-plans-for-construction-of-commercial-BTL-plant-move-forward.html>
- [12] Tijm, P. 1994. Shell Middle Distillate Synthesis: The Process, The Plant, The Products. http://web.anl.gov/PCS/acsfuel/preprint%20archive/Files/39_4_WASHINGTON%20DC_08-94_1146.pdf
- [13] van der Laan, P. 1999. Kinetics, Selectivity and Scale Up of the Fischer-Tropsch Synthesis. http://www.adktroutguide.com/files/1999_PhD_Thesis_-_Kinetics_Selectivity_and_Scaleup_of_FT_Synthesis.pdf
- [14] Industrial Equipment News. 2017. Mississippi Lands Biofuel Refinery. <https://www.ien.com/operations/news/20980331/mississippi-lands-biofuel-refinery>
- [15] Irena. 2016. Innovation Outlook. Advanced Liquid Biofuels. http://www.irena.org/DocumentDownloads/Publications/IRENA_Innovation_Outlook_Advanced_Liquid_Biofuels_2016.pdf
- [16] Sub Group on Advanced Biofuels. 2017. Cost of Biofuel. http://platformduurzamebiobrandstoffen.nl/wp-content/uploads/2017/07/2017_SGAB_Cost-of-Biofuels.pdf
- [17] de Jong, S., Hoefnagels, R., Faaij, A., Slade, R., Mawhood, R. and Junginger, M. 2015. The feasibility of short-term production strategies for renewable jet fuels – a comprehensive techno-economic comparison. *Biofuels, Bioprod. Bioref.*, 9: 778–800. <https://www.doi.org/10.1002/bbb.1613>
- [18] “Review of Technology for Gasification of Biomass and Wastes”, E4tech, June 2009 (p. 46).
- [19] “More efficient biomass gasification via torrefaction”, Prins et. al., 2006.

86 Hydrogen production via electrolysis

Contact Information:

Energinet.dk: Peter Erik Jørgensen, pjr@energinet.dk and Rasmus Thorsen, rto@energinet.dk

Danish Energy Agency: Christoph Wolter, chwo@ens.dk

Authors: Rasmus Rode Mosbæk, Hybrid Greentech ApS, rasmus@hybridgreentech.com

Roar Hestbek Nicolaisen, Hybrid Greentech ApS, roar@hybridgreentech.com

Megha Rao, Hybrid Greentech ApS

Publication date

April 2021

Amendments after publication date

Date	Ref.	Description
-	-	-

Qualitative description

In this chapter, three technologies are discussed namely: alkaline, polymer electrolyte membrane and solid oxide electrolysis, which are already available commercially. The aim of this chapter is to facilitate the reader to make an informed decision considering the technical as well as economical aspects of small and large-scale electrolysis systems. Although the data should not be used for specific investment decisions. Financial data is assumed to be at 2020 price level which deviates from the 2015 price level specified in the guideline.

Brief technology description

Alkaline electrolysis cells (AECs), polymer electrolyte membrane electrolysis cells (PEMECs) or simply polymer electrolyte membrane (PEM) for short, and solid oxide electrolysis cells (SOECs) will be described and compared. The operating principle for the electrolysis technologies relies on water splitting by electricity (electrolysis) according to the following reaction:

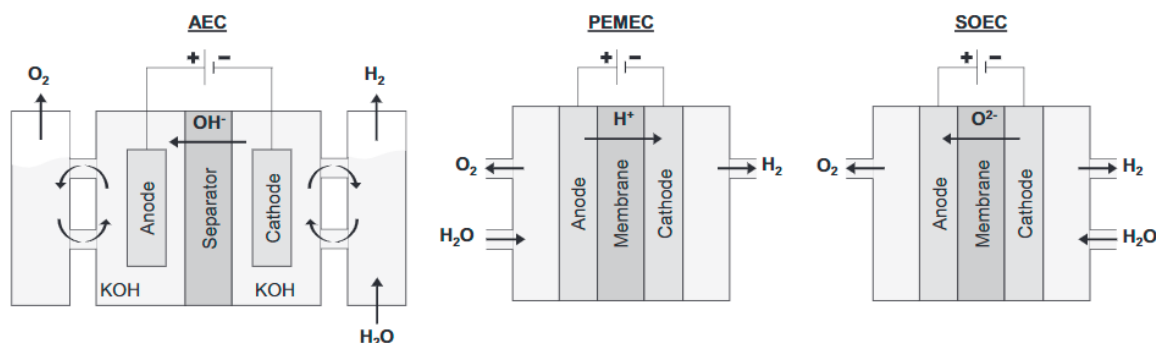
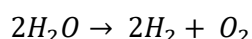
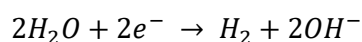

Figure 1: Operating principle of AEC, PEMEC and SOEC [1].

AECs are the most common electrolyzers available commercially. The cell operates at 65-90 °C and can work at either atmospheric pressure or pressurized at up to 35 bars. Experimental AECs are under investigation, which operates at up to 100 bars. The electrodes are typically made up of steel, nickel, or nickel-plated steel. Furthermore, a separation of the electrode compartments by a micro-porous diaphragm (a porous plate or cylinder responding to pressure difference) is performed to avoid blending of gases. The electrolyte is an aqueous solution of potassium hydroxide (KOH). In Figure 1, operation of AEC is presented. Water is fed to the cathode wherein during electrolysis operation, OH⁻ ions are transported across the membrane to form hydrogen and oxygen [2].

Reaction at cathode:



Reaction at anode:

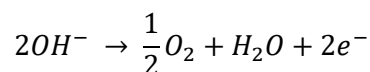

For PEM electrolysis, two electrodes are in contact with a proton exchange polymer electrolyte membrane, typically perfluorosulfonic acid (PFSA), forming a membrane electrode assembly (MEA). Typically, the membranes are catalyst coated and contacted by either expanded metal meshes or carbon or metallic felts. State-of-the-art (SoA) catalysts used commercially have a platinum cathode and an iridium oxide (IrO₂) anode. The reaction takes place by the transport of H⁺ ions across the membrane as presented in Figure 1. Water is fed at the anode and hydrogen is formed at the cathode [2].

Reaction at anode:

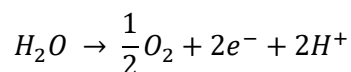

Reaction at cathode:

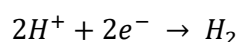

In the case of SOEC, the electrolyte is an oxide ion conducting solid phase component, commonly yttria stabilized zirconia (YSZ). The cathode is made up of nickel combined with YSZ to facilitate hydrogen generation. The anode comprises of mixed ionic-electronic conductors such as lanthanum strontium manganate (LSM) with YSZ. In Figure 1, operation of SOEC is displayed wherein O²⁻ is transported across the solid electrolyte. An advantage of SOEC lies in the ability to convert steam and CO₂ simultaneously to form syngas (co-electrolysis) [3].

Reaction at cathode:

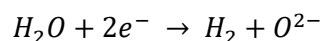

Reaction at anode:

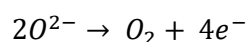

Apart from the three main electrolysis technologies, developments in the field of anion-exchange membrane electrolysis cells (AEMECs) is being researched on a lab scale. The electrolyte is alkaline in nature and the diaphragm comprises of an anion-exchange membrane. Similar to alkaline electrolysis, OH⁻ ions are transported across the diaphragm. The major advantage of AEMEC lies with the use of non-precious metal catalysts as well as use of low concentration of KOH or distilled water as electrolyte. The operating temperature is less than 100 °C. Research is being carried out to increase durability of cells.

Input

For all three electrolysis technologies, the input is electricity and water. For SOEC, PEMEC and AEC a high-water purity is desired. The water quality can be determined by the conductivity of the water used, the conductivity should be in the order of 1 μS/cm, 0.2 μS/cm and 5 μS/cm, respectively. SOEC uses steam rather than water and is thus a consumer of heat, rather than a producer of heat. If the hydrogen produced was to be used for synthetic fuel, then the waste heat of these synthesis processes (e.g. Fischer-Tropsch synthesis, Haber-Bosch process) could be used to produce steam for further SOEC electrolysis.

Output

For all three electrolysis technologies, the output is hydrogen, oxygen and excess heat from the process [3]. For SOEC, the recoverable excess heat will be used to produce steam that can then be used as input for further SOEC electrolysis. Oxygen is a by-product, which can be used in various industries, such as paper and pulp production, glass manufacturing, water oxygenation, fish farming, steel and metal industry, medical care industry, food, manufacturing, oxy fuel Carbon Capture and Storage (CCS), thermal gasification, and many more. The excess heat may be used for district heating in case of PEMEC and AEC. AEC and PEMEC systems are found in the literature to generally have operating temperatures of 50-80 °C and 60-80 °C [4]. Current systems (2020) can deliver heat at 50 °C possibly for district heating, according to the manufacturer, this is expected to increase to 70 °C by 2024.

Energy balance

An energy balance for each of the three electrolysis technologies, AEC, PEMEC and SOEC is investigated in this section and presented as Figure 2, 3 and 4. For AEC and PEMEC, the input is 100% electricity while for SOEC (in 2020) electricity is 79.5% of the input energy, while the remaining 20.5% is supplied by heating requirements. This differentiation is done since SOECs operate at higher temperature wherein, the water needs to be converted to steam and the operation occurs at temperatures over 600 °C.

Once water or steam is supplied to the electrolysis cells, formation of H₂ and O₂ takes place along with heat dissipation. Since the heat needs to be at a certain temperature to be fed into the district heating grid, only a percentage of the heat generated can be directly utilized. An important aspect related to the analysis performed herewith does not consider the latent heat of vaporization of steam in the product. This is performed in order to get an accurate analysis of the usable energy producing by electrolysis. The characteristics of input and output streams are presented in Figure 5, Figure 6 and Table 1.

An important aspect which has not been investigated in this chapter relates to the conversion of hydrogen to chemicals such as ammonia and methanol. These could be the two main energy carriers for Power-to-X

transition. In this context, SOEC is better suited than both AEC and PEMEC with regard to the heat integration aspects as well as co-electrolysis (conversion of CO₂ and steam simultaneously) [5].

In this section, energy flow diagrams with the efficiency of conversion to hydrogen and usable heat has been displayed. The hydrogen conversion efficiencies are based on IEA [23], see Table 5. For AEC and PEMEC, 5% of the energy is estimated to be unrecoverable heat loss [6]. According to Green Hydrogen Systems, the recoverable energy is available at 50 °C (2020) (expected to increase to 70 °C by 2024).

In Figure 2, the energy balance for AEC (2020) is shown, where 66.5% of the output is hydrogen (calculated on LHV basis), and 16.4% is recoverable heat which can potentially be used for district heating. Similarly, in Figure 3, the energy balance for PEMEC (2020) is shown, where 58% of the output is hydrogen (calculated on LHV basis), and 26.4% is recoverable heat which can potentially be used for district heating. Moreover, in Figure 4 the energy balance for SOEC (2020) is shown, where 77.5% of the output is hydrogen (calculated on LHV basis).

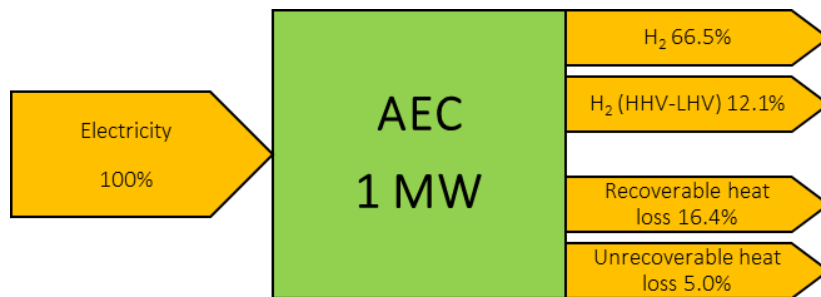

Figure 2: Energy balance (2020) for a 1 MW alkaline electrolysis cell compared on LHV basis.

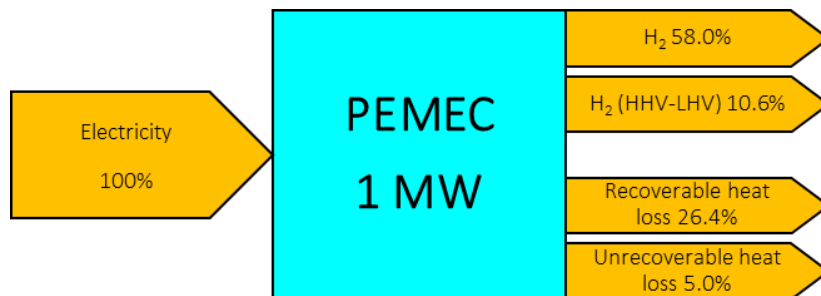

Figure 3: Energy balance (2020) for a 1 MW polymer electrolyte membrane electrolysis cell compared on LHV basis.

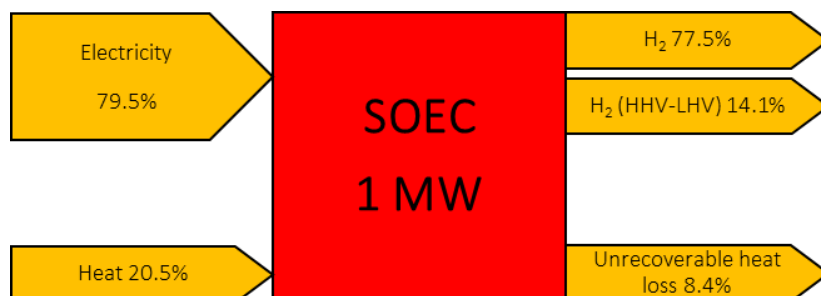

Figure 4: Energy balance (2020) for a 1 MW solid oxide electrolysis cell compared on LHV basis.

System description

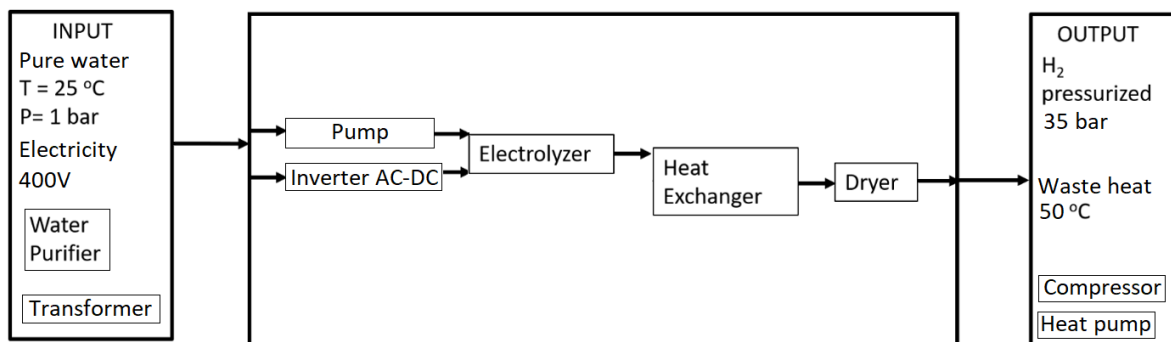

Figure 5: A sketch of an electrolysis system for AEC and PEM.

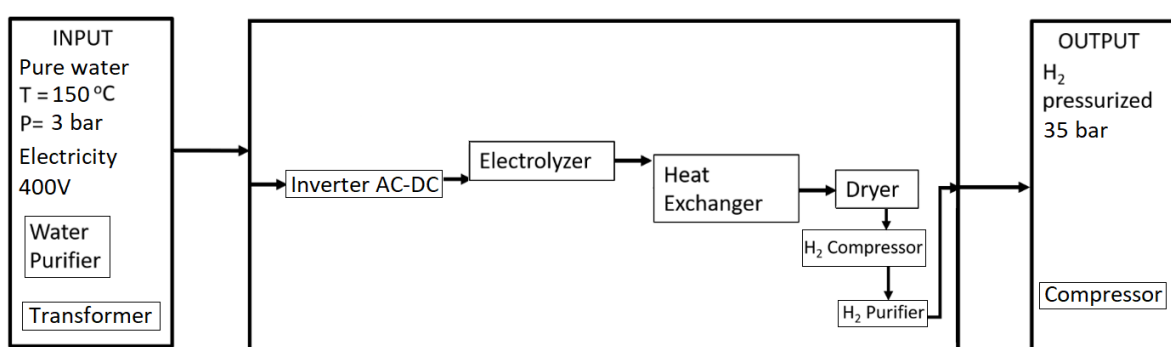

Figure 6: A sketch of an electrolysis system for SOEC.

Figure 5 describes the input required, the components in the system, and the output produced for an AEC or PEM system. Figure 6 describes the same for an SOEC system. The box on the left shows the required input and two components that are not included in the CAPEX, but which may be required depending on the local water quality and grid level. The box in the middle describes the system that have been analysed. All components in the central box are included in the CAPEX. The box on the right gives the output streams and components that are not included in CAPEX, but which may be required to upgrade the output streams.

In case of AEC, water is fed to the purifier from where it is sent to the AEC module. Herein, the water is compressed using a pump prior to entering the electrolyser stack. Once the electrolysis products are formed, they pass through a heat exchanger, followed by drying of the products prior to being sent for storage. The specifications based on commercially available systems are stated in Table 1 below.

Table 1: Specifications of the standard system (2020) used for analysis.

Technology	AEC	PEMEC	SOEC
Input temperature and pressure	25 °C, 1 bar	25 °C, 1 bar	150 °C, 3 bar
Input electricity	400 V _{AC}	400 V _{AC}	400 V _{AC}
Water for electrolysis purity (input)	5 µS/cm	0.2 µS/cm	1 µS/cm
H ₂ purity (output)	99.99	99.99	99.99

H ₂ output pressure (range)	35 bar (1-35 bar)	35 bar (1-50 bar)	35 bar (1-40 bar)
Waste heat temperature (output)	50 °C	50 °C	---

Typical capacities

Alkaline electrolysis plants on MW scale have been commissioned in Denmark and up to 1 GW of installed capacity is projected to be operational by 2030 [7]. NEL has projects in place for up to 20 MW [8]. In the context of PEMEC systems, Hydrogenics system has a 1.5 MW operational system in Germany [9] and NEL is expected to operate multiple fuelling stations with Nikola with upwards of 1000 MW installed capacity [8]. Siemens has the largest operational PEMEC installation of 3.75 MW consisting of three 1.25 MW electrolyzers in Energiepark Mainz [10]. SOEC systems can be found on sub-MW scale and mostly applied for Power-to-X scenarios [11]. Furthermore, EUDP projects both completed and ongoing for biogas upgrading [12] and ammonia synthesis [13] have been commissioned. Sunfire has their largest installation worth 750 kW in Salzgitter and plans to establish a 2.5 MW installation at Neste's refinery in Rotterdam. According to the commercially available systems, for AEC and PEMEC, analysis for cost potential is performed on both small- and large-scale systems while for SOEC, only small-scale system is considered. Large scale SOEC systems are technical feasible. Yet, the data available on large scale SOEC plants are sparse, hence, no datasheet have been prepared.

Regulation ability

Table 2: Regulation ability [14].

	AEC	PEM	SOEC
Cold start-up time (from 0 to 100%) [minutes]	<120	10 (5-10)	720 (680-880)
Warm start-up time (from 0 to 100%) [seconds]	240 (60-300)	<10	900
Power response signal [seconds]	<1 (<1-5)	<1 (<1-5)	<1 (<1-5)

In general, electrolysis systems can be operated very dynamically, limited mainly by the heat management, the maximum voltage of the rectifier, and the time coefficients of external components [14]. The cold start-up time, warm start-up time, and the power signal response for the three systems are displayed in Table 2. A cold start is defined as start-up from ambient temperature after a long shut-down. A warm start is defined as start-up from heated stand-by or idle mode, which means that the system is held at operating temperature and pressure if necessary. Power response signal is the time it takes for the system to adjust to a change in the power input and is measured in seconds. This rapid reaction may allow the system to stabilise power grids when the system is running at operating temperatures.

For 1 MW plants, the electrolysis would be connected to medium voltage grid connection in agreement with a DSO. For 100 MW plants, high voltage connection needs to be established with TSOs. DSOs and TSOs would specify the tariffs and the grid connection fee. Tarif structure could be designed to support flexible consumers by reducing the tariff on flexible consumption. The exact design may vary from case to case.

Space requirements

Space requirements have been determined based on the commercially available modules. Included in the estimation of space required are the components in the central boxes of Figure 5 and 6, excluded are the components in the input boxes on the left and output boxes on the right. Significant increases in the system sizes, compared to the present estimations, are expected if a transformer station or a compressor for delivering high pressure hydrogen (>50 bar) are required, on top of the base system. For alkaline electrolysis, Green Hydrogen systems was used as a reference which led to an estimation of 10-15 m²/MW in terms of input electric energy or 0.02-0.03 m²/(kgH₂/day) in terms of maximal daily hydrogen output (2020). For PEM electrolysis, NEL hydrogen systems were investigated leading to approximately 20 m²/MW in terms of input electric energy or 0.05 m²/(kgH₂/day) in terms of maximal daily hydrogen output (2020). For SOEC, Sunfire's modular systems were studied which resulted in approximately 35 m²/MW in terms of input electric energy or 0.06 m²/(kgH₂/day) in terms of maximal daily hydrogen output (2020).

Advantages/disadvantages

In this section, a summary of advantages and disadvantages of AEC, PEMEC and SOEC are displayed in Table 3. This table highlights the suitability of an electrolysis technology with respect to an application. The data is collected from literature [15][13].

Table 3: A summary of advantages and disadvantages of the electrolysis technologies investigated.

Technology	Advantages	Disadvantages
AEC	<ul style="list-style-type: none"> The technology is very mature and can be adapted to both centralized and decentralized plants. AEC has a low operating temperature, with a quick start up for response in grid services making it suitable for use as a flexible technology. Long stack lifetime of more than 100000h currently. MW scale systems are already being deployed. 	<ul style="list-style-type: none"> Less flexibility under atmospheric operation. The use of highly caustic electrolyte in AEC. Leakage of KOH. High membrane resistance. Low maximum operational current density, nominally operated around 0.6 A/cm² [16].
PEMEC	<ul style="list-style-type: none"> PEMEC has a low operating temperature, low noise, high power density. Quick response times Pressurized hydrogen can be produced for direct storage without compression; however, it is challenging. Current densities >1.0 A/cm² can be used for operational systems leading to compact system sizes. MW scale systems are already being deployed. 	<ul style="list-style-type: none"> Very sensitive to impurities, with a prerequisite of very pure water as input. Lifetime of the SoA system is still uncertain. Catalyst used in electrode layers are expensive and scarce. PEMEC modules are expensive due to catalysts and bipolar plates (oxide resistant stack elements). Cost efficient water treatment and drying the hydrogen at high pressure is still challenges to be addressed.
SOEC	<ul style="list-style-type: none"> SOEC has high efficiency, high production rates. SOECs can be operated at high current densities at or above 0.8 A/cm². SOECs can be used to make synthesis gas from co-electrolysis of steam and CO₂. CO-electrolysis plants have been commercialized. SOECs can cope with transient variations due to quick response times. SOEC can be used reverse mode as a fuel cell for grid balancing. 	<ul style="list-style-type: none"> SOECs are still in demonstration phase for large scale applications for hydrogen production and are not readily commercially available. The stack components are susceptible to corrosion. Current SoA lifetime is short compared to AEC and PEMEC.

Environment

For all the electrolysis technologies producing hydrogen, the only products are hydrogen, oxygen, and excess heat. Electrolysis can be used to balance fluctuations in the power supply and hence increase the value of electrolysis (clean energy carrier) by further conversion into chemicals. For AEC, the anode, the cathode, as well as the catalyst layer are usually nickel-based which is not a scarce resource. For PEMEC, the membranes consisting of fluoropolymer need to be disposed or recycled after use. In addition, the catalyst layer consisting of platinum and its alloys for the cathode, and iridium, ruthenium and their alloys for anode are scarce in nature leading to a possible hurdle in long-term operation of SoA PEMECs [17]. For SOEC, the lanthanum strontium manganate (LSM) anode is both hazardous and scarce in nature. These might obstruct the commercialization of large scale SOEC systems.

Research and development perspectives

For AECs, the main challenge is related to the resistance and temperature stability of the diaphragm. Currently the diaphragm is also limiting the operation temperature of the alkaline electrolyzers, therefore, research is being carried out to improve the temperature stability of the diaphragm by experimenting with various polymer substitutes. Additionally, extensive research is being conducted into improving the AEC catalyst as there is a significant room for improvement with respect to catalyst performance. Solid membranes have also been researched. Solid membranes are called AEMECs, as described earlier [18].

For PEMEC, stack cost is the major hurdle to commercialization of large-scale system. The cost of catalysts and bipolar plates are under investigation in terms of research on lab scale. Furthermore, scarcity of elements is considered while finding alternative materials for substitution. Both PEMECs and AECs are expected to aid with the H₂ fuelling market as envisioned by Denmark and Europe.

One of the key aspects to enable commercialization of electrolyser stacks deals with the durability of cells. According to Green Hydrogen Systems AEC stacks have a very long lifetime of over 100,000 hours (2020), PEMECs stacks can be operational for a reasonable operational lifetime of over 25,000 hours (2020) and the lifetime of PEMEC cells are expected to increase to 50,000 hours within a few years. SOECs, however, have high degradation rates leading to a short lifetime of about 20,000 hours (2020). This leads to a replacement of the stack each three and a third years, assuming 6000 operation hours per year. SOECs can be operated at high current densities i.e., higher conversion into hydrogen, but suffer from fast degradation, structural damage and weakening of electrode/electrolyte interfaces. Furthermore, loss in Ni percolation leading to less conductivity and more resistance to the flow of ions has also been reported [19]. For the Ni electrode, research on particle size distribution is being carried out while for the oxygen electrode, use of various mixed-ionic electronic conductors is being investigated. Furthermore, operation at thermoneutral voltage wherein, hydrogen and oxygen are produced with 100% thermal efficiency (i.e., no waste heat produced from the reaction) is desired for system optimization [3]. An advantage of SOEC lies in the possibility of reversible operation which has led to reduced degradation or even activation of the cell under certain operating parameters [20].

Combination of electrolysis technologies has also been suggested for research. However, given the difference in lifetime of technologies as well as sensitivity to impurities, AEC tends to be a superior choice when

combined with pressurized setup and district heating applications. However, this is solely dependent on application and each technology has its advantages when operated under certain set of conditions.

The market for electrolyzers has for years been dominated by a few legacy providers of – primarily – large (footprint and capacity) atmospheric electrolyzers delivered to a relatively limited and stable market for industrial hydrogen applications.

All of abovementioned efforts are aimed at making the technologies scalable both as decentralised and centralised systems to have sufficient hydrogen available for various applications. Electrolyser plants are now being subjected to MW scale for AECs and PEMECs, while SOECs so far only have found usage in kW scale. Reduction in price, availability of material, regulation ability as well as efficiency enhancement are being addressed to facilitate large-scale implementation of electrolyzers for hydrogen production [21].

Examples of market standard technology

In this section, analysis of different electrolysis systems deployed either commercially or in demonstration phase are summarized. The electrolyzers at different locations are deployed for various applications and their specifications are also summarized in Table 4.

Table 4: Examples of market technology for hydrogen production via electrolysis.

Image	Location	Type	Application	Year	Specifications	Technology Provider	Reference
	Aalborg, Denmark	AEC	H ₂ fuelling	2020	130 kg/day H ₂ ; 35, 350, 450 bar	Green Hydrogen Systems	[22]
	Arizona, USA	AEC	H ₂ fuelling	2019	2000 kg/day H ₂ ; 700 bar	NEL Hydrogen	[8]
	Herning, Denmark	AEC	H ₂ fuelling	2018	8000 kg/day H ₂ ; 700 bar	NEL Hydrogen	[23]

	Avedøre, Denmark	AEC	Power-to-Gas	2016	100 Nm ³ /hr H ₂ ; 10-27 bar	Hydrogenics	[9]
 <small>Elizabeth Britton, VP New Energy Shell (left) and Kati Simon, European Commissioner for Energy visiting the ICEHYD Project (10M Power PEM Electrolyser)</small>	Wesseling, Germany	PEMEC	Green H ₂ production; decarbonisation	2020	1300 tons/year H ₂ ; 10MW	ITM Power	[9]
	Energiepark Mainz, Germany	PEMEC	Wind to H ₂	2015	100-2000 kg/hr; 3.75 MW; 35 bars	Siemens	[10]
	Hamburg, Germany	PEMEC	Power-to-Gas	2015	285 Nm ³ /hr H ₂ ; 1.5 MW	Hydrogenics	[9]
	Karlsruhe, Germany	SOEC	Power-to-X	2019	4 Nm ³ /hr synthesis gas; 10 kW	Sunfire	[11]

Prediction of performance and costs

The foundation of the predictions of performance and costs are built on reports from IEA [24], HyEurope [21], IRENA [25] and input from the industry (AEC: Everfuel, Green Hydrogen Systems and NEL. PEM: Green Hydrogen Systems and Siemens). For AEC and PEM, O&M is observed to be between 2-5% of CAPEX pr. year, smaller systems have larger O&M and vice versa, 1.5% seems to be the ultimate lower limit as it relates to materials (no advantage of scale) [26]. A U.S. Department of Energy report indicates that the lifetime of the plants is expected increase in the future [27]. The electrolyser stack is responsible for about 30% of the total investment cost for AEC and PEMEC (Green Hydrogen Systems).

Table 5: Expected efficiency and CAPEX for AEC, PEMEC and SOEC [24].

	Alkaline electrolyser			PEM electrolyser			SOEC electrolyser		
	Today	2030	Long term	Today	2030	Long-term	Today	2030	Long term
Electrical efficiency (% LHV)	63–70	65–71	70–80	56–60	63–68	67–74	74–81	77–84	77–90
CAPEX (USD/kW _e)	500	400	200	1 100	650	200	2 800	800	500
	1400	850	700	1 800	1 500	900	5 600	2 800	1 000

Notes: LHV = lower heating value; m²/kW_e = square metre per kilowatt electrical. No projections made for future operating pressure and temperature or load range characteristics. For SOEC, electrical efficiency does not include the energy for steam generation. CAPEX represents system costs, including power electronics, gas conditioning and balance of plant; CAPEX ranges reflect different system sizes and uncertainties in future estimates.

Sources: Buttler and Spliethoff (2018), "Current status of water electrolysis for energy storage, grid balancing and sector coupling via power-to-gas and power-to-liquids: a review"; Agora Verkehrswende, Agora Energiewende and Frontier Economics (2018), *The Future Cost of Electricity-Based Synthetic Fuels*; NOW (2018), *Studie IndWEDe Industrialisierung der Wasserelektrolyse in Deutschland: Chancen und Herausforderungen für nachhaltigen Wasserstoff für Verkehr, Strom und Wärme*; Schmidt et al. (2017), "Future cost and performance of water electrolysis: An expert elicitation study"; FCH JU (2014), *Development of Water Electrolysis in the European Union, Final Report*; Element Energy (2018), "Hydrogen supply chain evidence base".

As an example of one of the sources, IEA's expected efficiency and CAPEX for the three technologies AEC, PEMEC and SOEC is presented in Table 5 [24].

In Figure 7, current and future CAPEX is estimated based predictions from reports and manufacturers. The CAPEX is assumed to include all components required for converting 400 V_{AC} electricity and purified water into H₂ gas at 35 bar and a waste heat stream at 50 °C (2020). CAPEX does not include transformer, water purifier, heat pumps for increasing the temperature of waste heat stream or compressors for increasing the pressure of H₂ further than 35 bar. In Figure 5 and 6, the components included are presented in the central box, while the input box on the left and the output box on the right includes optional components which are not part of CAPEX.

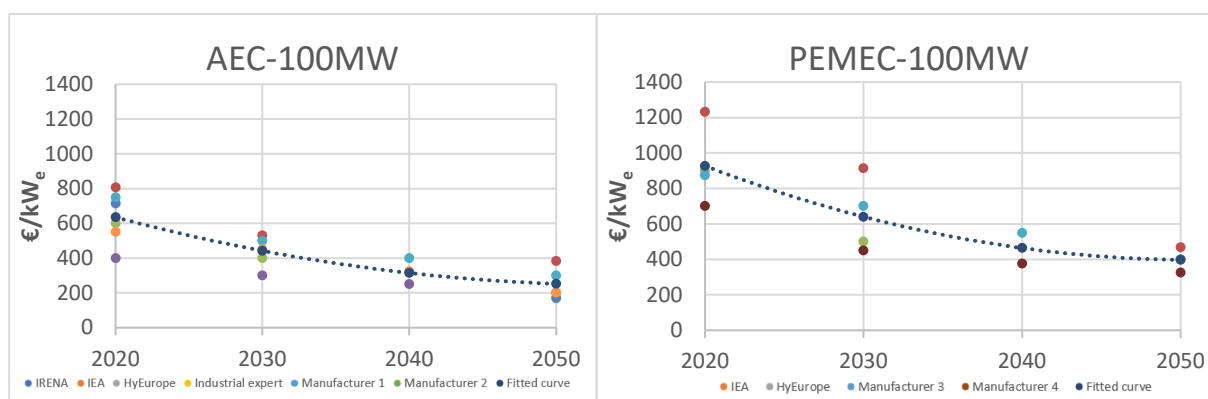

Figure 7: CAPEX values from industry interviews and three reports IEA [24], HyEurope [21] and IRENA [25]. The values in the datasheet correspond to the fitted curve. For IEA: "today" is taken to be 2020, "Long-term" is taken to be 2050 and values are the middle of the range given. An exchange rate of 0.85 Euro per USD was used.

The learning rate for AEC have been found to be 18% [1], 18% [28] and 9% [29]. While the learning rate of PEMEC fuel cells to be 19.1-21.4% [30], 18% [1], 16% [31] and 13% [29]. Assuming a 16% learning rate would imply that the total amount of units produced would have to double four times (16-fold increase) for the price per unit to drop by 50%. From the fitted curves in Figure 7, a 50% decrease of the 2020 unit price is expected to occur by 2040 for both AEC and PEMEC, indicating that the total amount of units produced 2040 will have doubled four times compared to the total amount of units produced by 2020. The total amount of AEC ever produced by 2014 was found to be 20 GW, much of it being deployed in the period from 1956 to 2005 [32] (See Supplementary Figure 2 in [32]). According to Wood Mackenzie the cumulative installed electrolyser capacity in the period from 2000 to 2019 is 253 MW [33]. Assuming 20 GW is produced until 2020, then doubling the cumulated capacity four times would lead to 320 GW having been produced by 2040. Under the Sustainable Development Scenario IEA predicts that the active global electrolyser capacity will be about 500 GW by 2040, a huge increase from about 170 MW active in 2019 [34]. A 50% decrease in price thus seems likely, if governments take the major actions required to fulfil the Sustainable Development Scenario.

As small and large electrolyser systems are built from the same building blocks the difference in CAPEX is expected to be small. Decreases in CAPEX is therefore expected to come from an increase in the amount of units produced, rather than an increase in the size of the systems deployed.

Most sources give the prices based on power input: €/kW. Some sources also give the price based on output €/(kg/d), taking the conversion efficiency into account. Particularly when comparing electrolysis technologies, it is better to use the output-based price and especially when comparing to SOEC, as a high conversion efficiency is its main advantage.

The main price decrease of the total system is expected to come from the electrolyser as this is the part of the system that is not produced at a large scale at present. Some innovations can also be envisioned for the electrolyser. For example, an increase in the area per cell, will reduce the material cost, as the active area becomes a larger part of the stack.

For SOEC, 100 MW scale plants have not been considered in the data sheets. However, literature studies have suggested the range of 380-500 €/kW for 100 MW scale plants under optimum operating conditions [35].

Uncertainty

The prices are estimated based on literature reports compiled by experts in academia and industry. However, the price projection is associated with a high level of uncertainty based on the previous lessons from the technology learning curves. Policies for hydrogen infrastructure are decisive commercialization of large-scale electrolysis systems. Furthermore, cost of scarce materials as well as economies of scale are also associated with a significant level of uncertainty.

Acknowledgements

The authors would like to thank Dr. Mogens Bjerg Mogensen and Dr. Jens Oluf Jensen for their contribution to the catalogue in the form of state-of-the-art research in the electrolysis technology. The authors would also like to thank Henrik Steen Pedersen and Kasper Tipsmark Therkildsen for their contribution to the chapter through his industrial expertise to enable reasonable cost predictions for alkaline and PEM electrolysis. A special thanks to Hergen Thore Wolf and Oliver Posdziech from Sunfire GmbH, and to Frank Allerbrod from H-TEC systems for his input on PEMECs. The authors acknowledge and appreciate the efforts of Søren Højgaard Jensen. The authors would also like to thank Rainer Kungas, Peter Blennow, John Bøggild Johnson and Thomas Heiredal Clausen from Haldor Topsøe for sharing relevant literature related to electrolysis systems. The authors would like to acknowledge Lars Henrik Riis and Arnim Hertle from Siemens for their valuable input. The authors would also like to acknowledge Uffe Borup from Everfuel for his input on large scale AEC systems. Last but not the least, the authors would like to acknowledge Laust Riemann and Thøger Kiørboe from Energistyrelsen.

Data sheets

Technology	Hydrogen production via alkaline electrolysis (AEC) for 1MW plant									
	2020	2030	2040	2050	Uncertainty (2020)		Uncertainty (2050)		Note	Ref
					Lower	Upper	Lower	Upper		
Energy/technical data										
Typical total plant size (MW input _e)	1	1	1	1	1	1	1	1		
Typical total plant size (kgH ₂ / day of max output)	479	490	515	540	454	504	504	576	L, E	
- Inputs										
Electricity (% total input (MWh / MWh))	100	100	100	100	100	100	100	100		
Water for electrolysis (kg / MWh input _e)	180	184	193	203	170	189	189	216		
- Outputs										
Hydrogen (% total input _e (MWh / MWh))	66.5	68.0	71.5	75.0	63.0	70.0	70.0	80.0	B	[24]
ΔE from HHV to LHV (% total input _e (MWh / MWh))	12.1	12.4	13.0	13.7	11.5	12.7	12.7	14.6	N	
Heat loss (% total input _e (MWh / MWh))	21.4	19.6	15.5	11.3	25.5	17.3	17.3	5.4		
- hereof unrecoverable heat loss (%-points of heat loss)	5.0	5.0	5.0	5.0	5.0	5.0	5.0	5.0	A	
- hereof recoverable for district heating (%-points of heat loss)	16.4	14.6	10.5	6.3	20.5	12.3	12.3	0.4	K	
Hydrogen (kg / MWh input _e)	20.0	20.4	21.5	22.5	18.9	21.0	21.0	24.0	B	[24]
Forced outage (%)	2	2	2	2	2	2	2	2	C	
Planned outage (days per year)	2	2	2	2	2	2	2	2	C	
Technical lifetime (years)	25	30	32	35	25	25	30	35	C, J	[27]
Construction time (years)	0.33	0.33	0.33	0.33	0.33	0.33	0.33	0.33	C, O	
Financial data (2020 price level)										
Specific investment (€ / kW of total input _e)	750	570	450	350	500	1400	200	700	D, I	
Specific investment (€ / kgH ₂ / day of max output)	1566	1164	874	648	1102	2778	397	1215	E, I, L	
- hereof equipment (%)	95	95	95	95	95	95	95	95	F	
- hereof installation (%)	5	5	5	5	5	5	5	5	F	
Fixed O&M (% of specific investment / year)	5	5	5	5	5	5	5	5	G, I, J	[26]
Variable O&M (€ / kWh of total input _e)	-	-	-	-					M	
Startup cost (€ / kW of total input _e per startup)	-	-	-	-						
Technology specific data										
Current Density (A / cm ²)	0.6	1	1.2	1.5	0.4	0.6	1.2	1.5	H	[21]
Footprint (m ² / MW input _e)	12.5	10	8	7.5	10	15	5	10	H	[21]

Notes (Datasheet for 1MW AEC):

- A 5% of the energy is estimated to be unrecoverable for small plants.
- B Values are from Table 5 in IEA [24], Today is understood as 2020, Long-term is understood as 2050 and the value selected is the mid of the range given.
- C According to the Green Hydrogen Systems (GHS).
- D The price estimates are from Green Hydrogen Systems.
- E For the unit regarding "day" a 100% load factor is assumed here (Where the system is operated at nominal capacity all 24 hours of the day). In operation the daily full load hours may vary and should therefore be adjusted for.
- F These are rough estimates based on operational AEC systems as provided by GHS.
- G O&M is estimated as 5% of CAPEX for small systems. According to the 2-5% given for large to small scale systems from [26].
- H The values are predicted until 2050 with a high margin of uncertainty. For 2030, the values are quite reasonable according to GHS.
- I The CAPEX includes all components required for converting 400VAC electricity and purified water into H₂ gas at 35 bar and a waste heat stream at 50 °C. CAPEX does not include transformer, water purifier, heat pumps for increasing the temperature of waste heat stream or compressors for increasing the pressure of H₂ further than 35 bar. The tariffs, capacity payments and network connection fees to DSO / TSO are not contained in CAPEX nor in O&M.
- J The lifetime of current AEC stacks is more than 100 000 hours according to Green Hydrogen Systems. Assuming that the facility is run for 4000h pr year, the stacks do not need replacement in the technical lifetime. If the full load hours exceed the 100 000h lifetime, then the stack replacement cost will be 30% of the CAPEX cost of a new system in the year of replacement. Everfuel gives a stack replacement of 30% of CAPEX and GHS informs that 30% of current CAPEX is stack cost. The cost of replacing the stack is not included in fixed O&M.
- K 50 °C (expected to increase to 70°C, by 2024).
- L Maximum hydrogen output per day, assuming 24 hours of full load operation in a day.
- M The price of the input streams (water and electric energy) has not been estimated.
- N The HHV electrolyser efficiency can be calculated as the sum of the rows: "ΔE from HHV to LHV" and "Hydrogen".
- O From the time of purchase to finished construction.

Technology	Hydrogen production via alkaline electrolysis (AEC) for 100MW plant									
	2020	2030	2040	2050	Uncertainty (2020)		Uncertainty (2050)		Note	Ref
					Lower	Upper	Lower	Upper		
Energy/technical data										
Typical total plant size (MW input _e)	100	100	100	100	100	100	100	100		
Typical total plant size (kgH ₂ / day of max output)	47880	48960	51480	54000	45360	50400	50400	57600	L, E	
- Inputs										
Electricity (% total input (MWh / MWh))	100	100	100	100	100	100	100	100		
Water for electrolysis (kg / MWh input _e)	180	184	193	203	170	189	189	216		
- Outputs										
Hydrogen (% total input _e (MWh / MWh))	66.5	68.0	71.5	75.0	63.0	70.0	70.0	80.0	B	[24]
ΔE from HHV to LHV (% total input _e (MWh / MWh))	12.1	12.4	13.0	13.7	11.5	12.7	12.7	14.6	N	
Heat loss (% total input _e (MWh / MWh))	21.4	19.6	15.5	11.3	25.5	17.3	17.3	5.4		
- hereof unrecoverable heat loss (%-points of heat loss)	3.0	3.0	3.0	3.0	3.0	3.0	3.0	3.0	A	
- hereof recoverable for district heating (%-points of heat loss)	18.4	16.6	12.5	8.3	22.5	14.3	14.3	2.4	K	
Hydrogen (kg / MWh input _e)	20.0	20.4	21.5	22.5	18.9	21.0	21.0	24.0	B	[24]
Forced outage (%)	2	2	2	2	2	2	2	2	C	
Planned outage (days per year)	2	2	2	2	2	2	2	2	C	
Technical lifetime (years)	25	30	32	35	25	25	30	35	C, J	[27]
Construction time (years)	0.33	0.33	0.33	0.33	0.33	0.33	0.33	0.33	C, O	
Financial data (2020 price level)										
Specific investment (€ / kW of total input _e)	650	450	300	250	400	800	150	400	D, I	
Specific investment (€ / kgH ₂ / day of max output)	1358	919	583	463	882	1587	298	694	E, I, L	
- hereof equipment (%)	90	90	90	90	90	90	90	90	F	
- hereof installation (%)	10	10	10	10	10	10	10	10	F	
Fixed O&M (% of specific investment / year)	2	2	2	2	2	2	2	2	G, I, J	[26]
Variable O&M (€ / kWh of total input _e)	-	-	-	-					M	
Startup cost (€ / kW of total input _e per startup)	-	-	-	-						
Technology specific data										
Current Density (A / cm ²)	0.6	1	1.2	1.5	0.4	0.6	1.2	1.5	H	[21]
Footprint (m ² / MW input _e)	12.5	10	8	7.5	10	15	5	10	H	[21]

Notes (Datasheet for 100MW AEC):

- A 3% of the energy is estimated to be unrecoverable for large plants.
- B Values are from Table 5 in IEA [24], Today is understood as 2020, Long-term is understood as 2050 and the value selected is the mid of the range given.
- C According to the Green Hydrogen Systems (GHS).
- D CAPEX values from interviews with GHS, Everfuel and NEL and reports from IEA [24], HyEurope [21] and IRENA [24]. The values in the datasheet correspond to a fitted curve see figure 6 in the catalogue. For IEA today is taken to be 2020, Long term is taken to be 2050 and values is the middle of the range given.
- E For the unit regarding "day" a 100% load factor is assumed here (Where the system is operated at nominal capacity all 24 hours of the day). In operation the daily full load hours may vary and should therefore be adjusted for.
- F These are rough estimates based on operational AEC systems as provided by the Green Hydrogen Systems.
- G O&M is estimated as 2% of CAPEX for large systems. According to the 2-5% given for large to small scale systems from [26].
- H The values are predicted until 2050 with a high margin of uncertainty.
- I The CAPEX includes all components required for converting 400VAC electricity and purified water into H₂ gas at 35 bar and a waste heat stream at 50 °C. CAPEX does not include transformer, water purifier, heat pumps for increasing the temperature of waste heat stream or compressors for increasing the pressure of H₂ further than 35 bar. The tariffs, capacity payments and network connection fees to DSO / TSO are not contained in CAPEX nor in O&M.
- J The lifetime of current AEC stacks is more than 100 000 hours according to Green Hydrogen Systems. Assuming that the facility is run for 4000h pr year, the stacks do not need replacement in the technical lifetime. If the full load hours exceed the 100 000h lifetime, then the stack replacement cost will be 30% of the CAPEX cost of a new system in the year of replacement. Everfuel gives a stack replacement of 30% of CAPEX and GHS informs that 30% of current CAPEX is stack cost. The cost of replacing the stack is not included in fixed O&M.
- K 50 °C (expected to increase to 70°C, by 2024).
- L Maximum hydrogen output per day, assuming 24 hours of full load operation in a day.
- M The price of the input streams (water and electric energy) has not been estimated.
- N The HHV electrolyser efficiency can be calculated as the sum of the rows: "ΔE from HHV to LHV" and "Hydrogen".
- O From the time of purchase to finished construction.

Technology	Hydrogen production via PEM electrolysis for 1MW plant									
	2020	2030	2040	2050	Uncertainty (2020)		Uncertainty (2050)		Note	Ref
					Lower	Upper	Lower	Upper		
Energy/technical data										
Typical total plant size (MW input _e)	1	1	1	1	1	1	1	1		
Typical total plant size (kgH ₂ / day of max output)	418	472	490	508	432	461	490	504	L, E	
- Inputs										
Electricity (% total input (MWh / MWh))	100	100	100	100	100	100	100	100		
Water for electrolysis (kg / MWh input _e)	157	177	184	190	162	173	184	189		
- Outputs										
Hydrogen (% total input _e (MWh / MWh))	58.0	65.5	68.0	70.5	60.0	64.0	68.0	70.0	B	[24]
ΔE from HHV to LHV (% total input _e (MWh / MWh))	10.6	11.9	12.4	12.8	10.9	11.7	12.4	12.7	N	
Heat loss (% total input _e (MWh / MWh))	31.4	22.6	19.6	16.7	29.1	24.3	19.6	17.3		
- hereof unrecoverable heat loss (%-points of heat loss)	5.0	5.0	5.0	5.0	5.0	5.0	5.0	5.0	A	
- hereof recoverable for district heating (%-points of heat loss)	26.4	17.6	14.6	11.7	24.1	19.3	14.6	12.3	K	
Hydrogen (kg / MWh input _e)	17.4	19.7	20.4	21.2	18.0	19.2	20.4	21.0	B	[24]
Forced outage (%)	2	2	2	2	2	2	2	2	C	
Planned outage (days per year)	2	2	2	2	2	2	2	2	C	
Technical lifetime (years)	20	25	28	30	20	20	25	30	C, J	[27]
Construction time (years)	0.33	0.33	0.33	0.33	0.33	0.33	0.33	0.33	C, O	
Financial data (2020 price level)										
Specific investment (€ / kW of total input _e)	925	650	450	400	700	1250	300	500	D, I	
Specific investment (€ / kgH ₂ / day of max output)	2215	1378	919	788	1620	2712	613	992	E, I, L	
- hereof equipment (%)	95	95	95	95	95	95	95	95	F	
- hereof installation (%)	5	5	5	5	5	5	5	5	F	
Fixed O&M (% of specific investment / year)	7	7	7	7	7	7	7	7	G, I, J	
Variable O&M (€ / kWh of total input _e)	-	-	-	-					M	
Startup cost (€ / kW of total input _e per startup)	-	-	-	-						
Technology specific data										
Current Density (A / cm ²)	2.2	3.5	3.8	4	2.2	2.2	3.2	4		[21]
Footprint (m ² / MW input _e)	20	20	20	20	20	20	20	20	H	

Notes (Datasheet for 1MW PEMEC):

- A 5% of the energy is estimated to be unrecoverable for small plants.
- B Values are from Table 5 in IEA [24], Today is understood as 2020, Long-term is understood as 2050 and the value selected is the mid of the range given.
- C According to the Green Hydrogen Systems (GHS).
- D CAPEX values from interviews with GHS and Siemens and reports from IEA [24], HyEurope [21] and IRENA [24]. The values in the datasheet correspond to a fitted curve see figure 6 in the catalogue. For IEA today is taken to be 2020, Long term is taken to be 2050 and values is the middle of the range given.
- E For the unit regarding "day" a 100% load factor is assumed here (Where the system is operated at nominal capacity all 24 hours of the day). In operation the daily full load hours may vary and should therefore be adjusted for.
- F These are rough estimates based on existing systems according to GHS.
- G O&M is estimated as 7% of CAPEX. 5%-point is for small systems, according to the 2-5% given for large to small scale systems from [26]. 2%-points is the estimated stack replacement cost. Everfuel and GHS reports that the 30% of CAPEX is stack cost. At about 4000 full load hours per year, stacks are likely to be replaced twice during the technical lifetime.
- H This value is fixed due to no increase in research in increasing the pressure of PEMEC systems.
- I The CAPEX includes all components required for converting 400VAC electricity and purified water into H₂ gas at 35 bar and a waste heat stream at 50 °C. CAPEX does not include transformer, water purifier, heat pumps for increasing the temperature of waste heat stream or compressors for increasing the pressure of H₂ further than 35 bar. The tariffs, capacity payments and network connection fees to DSO / TSO are not contained in CAPEX nor in O&M.
- J The lifetime of current PEMEC stacks is more than 25000 hours and in the future it could be more than 50000 hours according to Green Hydrogen Systems.
- K 50 °C (expected to increase to 70°C, by 2024).
- L Maximum hydrogen output per day, assuming 24 hours of full load operation in a day.
- M The price of the input streams (water and electric energy) has not been estimated.
- N The HHV electrolyser efficiency can be calculated as the sum of the rows: "ΔE from HHV to LHV" and "Hydrogen".
- O From the time of purchase to finished construction.

Technology	Hydrogen production via PEM electrolysis for 100MW plant									
	2020	2030	2040	2050	Uncertainty (2020)		Uncertainty (2050)		Note	Ref
					Lower	Upper	Lower	Upper		
Energy/technical data										
Typical total plant size (MW input _e)	100	100	100	100	100	100	100	100		
Typical total plant size (kgH ₂ / day of max output)	41760	47160	48960	50760	43200	46080	48960	50400	L, E	
- Inputs										
Electricity (% total input (MWh / MWh))	100	100	100	100	100	100	100	100		
Water for electrolysis (kg / MWh input _e)	157	177	184	190	162	173	184	189		
- Outputs										
Hydrogen (% total input _e (MWh / MWh))	58.0	65.5	68.0	70.5	60.0	64.0	68.0	70.0	B	[24]
ΔE from HHV to LHV (% total input _e (MWh / MWh))	10.6	11.9	12.4	12.8	10.9	11.7	12.4	12.7	H	
Heat loss (% total input _e (MWh / MWh))	31.4	22.6	19.6	16.7	29.1	24.3	19.6	17.3		
- hereof unrecoverable heat loss (%-points of heat loss)	3.0	3.0	3.0	3.0	3.0	3.0	3.0	3.0	A	
- hereof recoverable for district heating (%-points of heat loss)	28.4	19.6	16.6	13.7	26.1	21.3	16.6	14.3	K	
Hydrogen (kg / MWh input _e)	17.4	19.7	20.4	21.2	18.0	19.2	20.4	21.0		[24]
Forced outage (%)	2	2	2	2	2	2	2	2	C	
Planned outage (days per year)	2	2	2	2	2	2	2	2	C	
Technical lifetime (years)	20	25	28	30	20	20	25	30	C, J	[27]
Construction time (years)	0.33	0.33	0.33	0.33	0.33	0.33	0.33	0.33	C, O	
Financial data (2020 price level)										
Specific investment (€ / kW of total input _e)	925	650	450	400	700	1250	300	500	D, I	
Specific investment (€ / kgH ₂ / day of max output)	2215	1378	919	788	1620	2712	613	992	E, I, L	
- hereof equipment (%)	90	90	90	90	90	90	90	90	F	
- hereof installation (%)	10	10	10	10	10	10	10	10	F	
Fixed O&M (% of specific investment / year)	4	4	4	4	4	4	4	4	G, I, J	
Variable O&M (€ / kWh of total input _e)	-	-	-	-					M	
Startup cost (€ / kW of total input _e per startup)	-	-	-	-						
Technology specific data										
Current Density (A / cm ²)	2.2	3.5	3.8	4	2.2	2.2	3.2	4		[21]
Footprint (m ² / MW input _e)	20	20	20	20	20	20	20	20	H	

Notes (Datasheet for 100MW PEMEC):

- A 3% of the energy is estimated to be unrecoverable for large plants.
- B Values are from Table 5 in IEA [24], Today is understood as 2020, Long-term is understood as 2050 and the value selected is the mid of the range given.
- C According to the Green Hydrogen Systems (GHS).
- D CAPEX values from interviews with GHS and Siemens and reports from IEA [24], HyEurope [21] and IRENA [24]. The values in the datasheet correspond to a fitted curve see figure 6 in the catalogue. For IEA today is taken to be 2020, Long term is taken to be 2050 and values is the middle of the range given.
- E For the unit regarding "day" a 100% load factor is assumed here (Where the system is operated at nominal capacity all 24 hours of the day). In operation the daily fullload hours may vary and should therefor be adjusted for.
- F These are rough estimates based on existing systems according to GHS.
- G O&M is estimated as 4% of CAPEX. 2%-point is for small systems, according to the 2-5% given for large to small scale systems from [26]. 2%-points is the estimated stack replacement cost. Everfuel and GHS reports that the 30% of CAPEX is stack cost. At about 4000 full load hours per year, stacks are likely to be replaced twice during the technical lifetime.
- H This value is fixed due to no increase in research in increasing the pressure of PEMEC systems.
- I The CAPEX includes all components required for converting 400VAC electricity and purified water into H₂ gas at 35 bar and a waste heat stream at 50 °C. CAPEX does not include transformer, water purifier, heat pumps for increasing the temperature of waste heat stream or compressors for increasing the pressure of H₂ further than 35 bar. The tariffs, capacity payments and network connection fees to DSO / TSO are not contained in CAPEX nor in O&M
- J The lifetime of current PEMEC stacks is more than 25000 hours and in the future it could be more than 50000 hours according to Green Hydrogen Systems.
- K 50 °C (expected to increase to 70°C, by 2024)
- L Maximum hydrogen output per day, assuming 24 hours of full load operation in a day.
- M The price of the input streams (water and electric energy), has not been estimated.
- N The HHV electrolyser efficiency can be calculated as the sum of the rows: "ΔE from HHV to LHV" and "Hydrogen".
- O From the time of purchase to finished construction

Technology	Hydrogen production via solid oxide electrolysis (SOEC) for 1MW plant									
	2020	2030	2040	2050	Uncertainty (2020)		Uncertainty (2050)		Note	Ref
					Lower	Upper	Lower	Upper		
Energy/technical data										
Typical total plant size (MW input)	1	1	1	1	1	1	1	1	A	
Typical total plant size (kgH ₂ / day of max output)	558	580	590	601	533	583	554	609	E	
- Inputs										
Electricity (% total input (MWh / MWh))	79.5	80.5	81.4	81.4	79.0	82.0	81.0	83.0	A	
Heat (% total input (MWh / MWh))	20.5	19.5	18.6	18.6	21.0	18.0	19.0	17.0		
Water for electrolysis (kg / MWh input)	209	217	221	225	200	219	208	228		
- Outputs										
Hydrogen (% total input (MWh / MWh))	77.5	80.5	82	83.5	74.0	81.0	77.0	84.6	B, D	[24]
ΔE from HHV to LHV (% total input (MWh / MWh))	14.1	14.7	14.9	15.2	13.5	14.8	14.0	15.4	H	
Heat loss (% total input (MWh / MWh))	8.4	4.8	3.1	1.3	12.5	4.2	9.0	0.0		
Hydrogen (kg / MWh input)	23.3	24.2	24.6	25.1	22.2	24.3	23.1	25.4		
Forced outage (%)	1.4	1.4	1.4	1.4	1.4	1.4	1.4	1.4	A	
Planned outage (days per year)	5	5	5	5	5	5	5	5	A	
Technical lifetime (years)	10	20	20	20	10	10	15	20	A	
Construction time (months)	4.0	0.5	0.5	0.5	4.0	4.0	0.5	1.0	A	
Financial data (2020 price level)										
Specific investment (€ / kW of total input)	4491	1901	1342	783	3013	5805	525	1024	D, G	[24]
Specific investment (€ / kgH ₂ / day of max output)	8047	3279	2273	1303	5654	9952	946	1681	D, G, E	[24]
- hereof equipment (%)	80	80	80	80	80	80	80	80	A	
- hereof installation (%)	20	20	20	20	20	20	20	20	A	
Fixed O&M (% of specific investment / year)	12	12	12	12	12	12	12	12	E, G, I	[21]
Variable O&M (€ / kWh of total input)	-	-	-	-					F	
Startup cost (€ / kW of total input per startup)	-	-	-	-						
Technology specific data										
Current Density (A / cm ²)	0.65	1	1.5	1.5	0.5	0.65	1.5	1.8		[21]
Footprint (m ² / MW input)	35.0	20.0	15.0	10.0	35.0	35.0	10.0	20.0		[21]

Notes (Datasheet for 1MW SOEC):

- A Input from Haldor Topsoe
- B The efficiencies are assumed to be system efficiencies. IEA gives the values as electric efficiencies, however the references of IEA gives both system efficiencies and electric efficiencies. See for instance Buttler and Spliethoff (2018), "Current status of water electrolysis for energy storage, grid balancing and sector coupling via power-to-gas and power-to-liquids: A review". This assumption adds significant uncertainty to these values. However no good alternative was found.
- C For the unit regarding "day" a 100% load factor is assumed here (Where the system is operated at nominal capacity all 24 hours of the day). In operation the daily full load hours may vary and should therefore be adjusted for.
- D Values are from Table 5 in IEA [24], Today is understood as 2020, Long-term is understood as 2050 and the value selected is the mid of the range given. For conversion a conversion of 0.85€/€ was used.
- E O&M is estimated as 12% of CAPEX. 5%-point is for small systems, according to the 2-5% given for large to small scale systems from [26]. 7%-points is the estimated stack replacement cost. Ceres Power gives a stack replacement cost of 20% of CAPEX. At about 6000 full load hours per year, stacks are likely to be replaced every three and a third years.
- F The price of the input streams (steam and electric energy) has not been estimated.
- G The CAPEX includes all components required for converting 400VAC electricity and purified water into H₂ gas at 35 bar. CAPEX does not include transformer, water purifier or compressors for increasing the pressure of H₂ further than 35 bar. The tariffs, capacity payments and network connection fees to DSO / TSO are not contained in CAPEX nor in O&M.
- H The HHV electrolyser efficiency can be calculated as the sum of the rows: "ΔE from HHV to LHV" and "Hydrogen".
- I The lifetime of current SOEC stacks is about 20000 hours and is expected to increase in the future [24], and is expected to increase in the future.

References

- [1] O. Schmidt, A. Gambhir, I. Staffell, A. Hawkes, J. Nelson, and S. Few, "Future cost and performance of water electrolysis: An expert elicitation study," *Int. J. Hydrogen Energy*, vol. 42, no. 52, pp. 30470–30492, 2017, doi: 10.1016/j.ijhydene.2017.10.045.
- [2] K. Scott, "Chapter 1: Introduction to Electrolysis, Electrolysers and Hydrogen Production," *RSC Energy Environ. Ser.*, vol. 2020-Janua, no. 25, pp. 1–27, 2020, doi: 10.1039/9781788016049-00001.
- [3] T. Data and R. Fuels, "Page 1 | 259 - Technology Data for Renewable Fuels," pp. 1–259.
- [4] M. Carmo, D. L. Fritz, J. Mergel, and D. Stolten, "A comprehensive review on PEM water electrolysis," *Int. J. Hydrogen Energy*, vol. 38, no. 12, pp. 4901–4934, 2013, doi: <https://doi.org/10.1016/j.ijhydene.2013.01.151>.
- [5] A. Hauch *et al.*, "Recent advances in solid oxide cell technology for electrolysis," *Science (80-.)*, vol. 370, no. 6513, 2020, doi: 10.1126/science.aba6118.
- [6] B. V. Mathiesen *et al.*, "Technology data for high temperature solid oxide electrolyser cells, alkali and PEM electrolysers," Department of Development and Planning, Aalborg University, Aug. 2013.
- [7] "Green Hydrogen Systems," no. June, pp. 0–16, 2020.
- [8] M. Conference, "NEL hydrogen," *Tech. data*, p. Online, 2014, [Online]. Available: <http://www.nel-hydrogen.com/home/?pid=75>.
- [9] B. D. Thomas and B. D. M. Power-to-gas, "By Denis Thomas, Business Development Manager Power-to-Gas, Hydrogenics UKHFC2016, Birmingham, 15 March 2016, Session 2: Large Scale Static Applications," no. March, 2016.
- [10] Siemens, "Kick-off for world's largest electrolysis system in Mainz." .
- [11] "BREAKTHROUGH FOR POWER-TO-X: SUNFIRE PUTS FIRST Co-ELECTROLYSIS INTO OPERATION AND

- STARTS SCALING - Sunfire." <https://www.sunfire.de/en/news/detail/breakthrough-for-power-to-x-sunfire-puts-first-co-electrolysis-into-operation-and-starts-scaling> (accessed Dec. 18, 2020).
- [12] J. B. Hansen, "El-opgraderet biogas." <https://energiforskning.dk/node/7155> (accessed Oct. 28, 2020).
- [13] J. B. Hansen, "Fasstofoxid Celle baseret Produktion og Anvendelse af Ammoniak." <https://energiforskning.dk/node/9306> (accessed Oct. 28, 2020).
- [14] A. Buttler and H. Spliethoff, "Current status of water electrolysis for energy storage, grid balancing and sector coupling via power-to-gas and power-to-liquids: A review," *Renew. Sustain. Energy Rev.*, vol. 82, pp. 2440–2454, 2018, doi: <https://doi.org/10.1016/j.rser.2017.09.003>.
- [15] S. Bruce *et al.*, "National Hydrogen Roadmap (Australia)," *Csiro*, 2018, [Online]. Available: <https://www.csiro.au/en/Do-business/Futures/Reports/Hydrogen-Roadmap>.
- [16] GreenHydrogen, "HyProvide A-series TechNote," 2020.
- [17] Lotrič A., Stropnik R., Mori M., Drobnič B., Jurjevčič B., and Sekavčnik M., "D2.1 Assessment of critical materials and components in FCH technologies: New technologies and strategies for fuel cells and Hydrogen Technologies in the phase of recycling and dismantling," no. 700190, 2017, [Online]. Available: <http://hytechcycling.eu/wp-content/uploads/D2.1-Identification-of-critical-materials.pdf><http://hytechcycling.eu/wp-content/uploads/D2.4-Recommendation-and-perspective-on-EU-regulatory-framework.pdf><http://hytechcycling.eu/wp-content/uploads/D2.5-Stud>.
- [18] M. K. Cho *et al.*, "A review on membranes and catalysts for anion exchange membrane water electrolysis single cells," *J. Electrochem. Sci. Technol.*, vol. 8, no. 3, pp. 183–196, 2017, doi: 10.5229/JECST.2017.8.3.183.
- [19] A. Hauch, K. Brodersen, M. Chen, and M. B. Mogensen, "Ni/YSZ electrodes structures optimized for increased electrolysis performance and durability," *Solid State Ionics*, vol. 293, pp. 27–36, 2016, doi: 10.1016/j.ssi.2016.06.003.
- [20] J. B. Hansen, "Fasstofoxid Celle baseret Produktion og Anvendelse af Ammoniak." .
- [21] H. Europe, "Strategic research and innovation agenda for lightweight," no. July, p. 157, 2020.
- [22] Green Hydrogen Systems, "GHS helps Danish city put hydrogen buses in service." .
- [23] B. Simonsen, "Scaling up electrolyser manufacturing by 10x causes and effects."
- [24] "The Future of Hydrogen," *Futur. Hydrog.*, no. June, 2019, doi: 10.1787/1e0514c4-en.
- [25] "Hydrogen: A renewable energy perspective," */publications/2019/Sep/Hydrogen-A-renewable-energy-perspective*, Accessed: Dec. 17, 2020. [Online]. Available: */publications/2019/Sep/Hydrogen-A-renewable-energy-perspective*.
- [26] "Development of Water Electrolysis in the European Union | www.fch.europa.eu." <https://www.fch.europa.eu/node/783> (accessed Dec. 17, 2020).

- [27] J. Ivy, "Summary of electrolytic hydrogen production," *Small*, no. September, p. 27, 2004, [Online]. Available: <http://www.nrel.gov/docs/fy04osti/35948.pdf>.
- [28] K. Schoots, F. Ferioli, G. J. Kramer, and B. C. C. van der Zwaan, "Learning curves for hydrogen production technology: An assessment of observed cost reductions," *Int. J. Hydrogen Energy*, vol. 33, no. 11, pp. 2630–2645, Jun. 2008, doi: 10.1016/j.ijhydene.2008.03.011.
- [29] "Path to Hydrogen Competitiveness: A Cost Perspective - Hydrogen Council." <https://hydrogencouncil.com/en/path-to-hydrogen-competitiveness-a-cost-perspective/> (accessed Dec. 20, 2020).
- [30] I. Staffell, "FUEL CELLS FOR DOMESTIC HEAT AND POWER: ARE THEY WORTH IT?," 2009. Accessed: Dec. 16, 2020. [Online]. Available: <http://etheses.bham.ac.uk/id/eprint/641/>.
- [31] I. Staffell and R. Green, "The cost of domestic fuel cell micro-CHP systems," *Int. J. Hydrogen Energy*, vol. 38, no. 2, pp. 1088–1102, Jan. 2013, doi: 10.1016/j.ijhydene.2012.10.090.
- [32] O. Schmidt, A. Hawkes, A. Gambhir, and I. Staffell, "The future cost of electrical energy storage based on experience rates," *Nat. Energy*, vol. 2, no. 8, Aug. 2017, doi: 10.1038/nenergy.2017.110.
- [33] "The future for green hydrogen | Wood Mackenzie." <https://www.woodmac.com/news/editorial/the-future-for-green-hydrogen> (accessed Jan. 07, 2021).
- [34] "Energy Technology Perspectives 2020 – Analysis - IEA." <https://www.iea.org/reports/energy-technology-perspectives-2020> (accessed Jan. 07, 2021).
- [35] M. Mogensen and S. Jensen, "Performance of reversible solid oxide cells: a review," *Proc. 7th ...*, no. June 2014, pp. 1–11, 2006.

89 Vegetable Oil FAME

Contact Information:

Danish Energy Agency: Jacob Hjerrild Zeuthen, jhz@ens.dk and Filip Gamborg, fgb@ens.dk

Author: Don O'Connor – (S&T)² Consultants Inc.

Publication date

August 2018

Amendments after publication date

Date	Ref.	Description
12 2018		Datasheet revised

Qualitative Description

Fatty Acid Methyl Esters (FAME) otherwise known as biodiesel can be produced from vegetable oils such as rapeseed and soy oil as well as from used cooking oil and recycled animal fats. This section discusses the production from vegetable oils and the next section discusses the production from used cooking oil and animal fats as the feedstock free fatty acid (FFA) content has some impact on capital and operating costs.

Biodiesel production and use began in Europe in the early 1990's and that region is still the leading biodiesel marketer and producer. Biodiesel production has since expanded to all regions of the world and there is some international trade in both biodiesel feedstocks and biodiesel.

The European Biodiesel Board reported that the FAME production capacity in Denmark in 2016 was 250,000 tonnes.

Brief Technology Description

The production of biodiesel, or methyl esters, is a well-known process. Vegetable oils are mixed with methanol in the presence of a catalyst at moderate pressure and temperatures to produce biodiesel and glycerine. Since the methanol is not soluble in the oil, this reaction will proceed either exceedingly slowly or not at all, so heat, as well as catalysts (acid and/or base) are used to speed the reaction. Almost all biodiesel produced from virgin vegetable oils uses the base-catalyzed technique as it is the most economical process for treating virgin vegetable oils, requiring only low temperatures and pressures and producing over 98% conversion yield (provided the starting oil is low in moisture and free fatty acids).

After the vegetable oil and methanol react in the presence of a catalyst to produce the biodiesel, the product goes through a number of separation and purification steps to recover the excess methanol for re-use, isolate the glycerine for potential upgrading and ensure that the methyl ester meets the required specifications.

The general biodiesel production process is shown in the following figure.

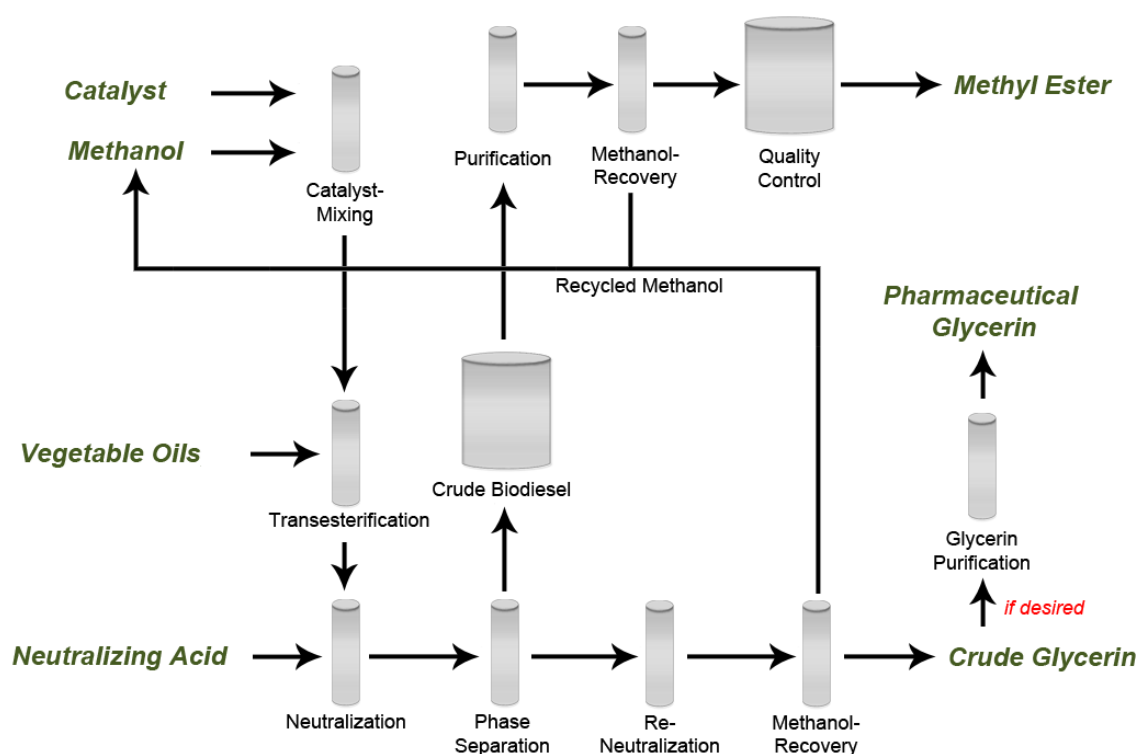

Figure 1 Biodiesel Production Process

There are other processing schemes that can be used to produce FAME from vegetable oils including the use of heterogeneous catalysts, enzymes instead of chemical catalysts and a supercritical process. This catalyst-free method for transesterification uses supercritical methanol at high temperatures and pressures in a continuous process. In the supercritical state, the oil and methanol are in a single phase, and reaction occurs spontaneously and rapidly. The process can tolerate water in the feedstock; free fatty acids are converted to methyl esters instead of soap, so a wide variety of feedstocks can be used. Also the catalyst removal step is eliminated. High temperatures and pressures are required, but energy costs of production are similar or less than catalytic production routes. These alternative processes are not yet widely practiced.

Input

The primary inputs to the production process are the vegetable oil, methanol, electricity, some thermal energy, the catalyst, and some acids and bases to treat the feedstocks and finished products.

Output

The plants produce FAME, glycerine (of various qualities), and in some cases potassium salts that can be sold as fertilizer.

Energy Balance

The energy balance is shown graphically in the following figure. The external energy inputs, in the form of heat and power, are relatively small and the process is quite efficient. The sum of the inputs totals 100 MJ.

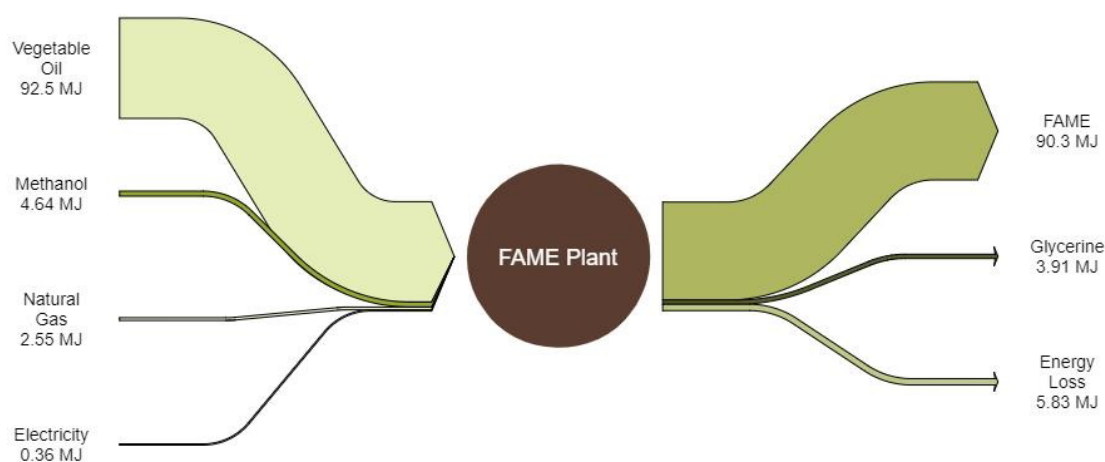

Figure 2 Vegetable Oil FAME Energy Balance

A small portion, about 5%, of the energy losses has the potential to be recovered as low level district heat [1].

Typical Capacities

Production capacities for individual plants can range from less than 10,000 tonnes per year to almost 600,000 tonnes per year (10 to 750 MW).

It was reported that in 2010, 46 FAME plants in Germany had a production capacity of almost 5 million tonnes per year [2]. The average plant size was 100,000 tonnes but more than 50% of the plant production capacity was found in 9 plants with more than 200,000 tonnes of capacity each.

Regulation Ability

FAME plants can be either batch or continuous processes. The time between batches regulates the total production from batch plants. Larger plants are generally continuous processes. The throughput can be regulated to a degree but process start-up is generally fast so regulating the days of operation is also a viable means to regulate production.

Space Requirements

A 100,000 tonne per year facility can be located on a site of less than 5 ha. This is equivalent to 0.04 ha/million litres of fuel, or 400 m²/MW. Factors that impact the required area include storage capacity of inputs and outputs and whether or not rail access is included at the facility.

Advantages/Disadvantages

FAME biodiesel is a relatively simple process that is well proven commercially. The capital costs are relatively low and the non-feedstock operating costs are also reasonable.

The feedstock costs are high compared to crude oil. The finished fuel has less desirable cold weather properties than fossil diesel fuel limiting its potential inclusion rates in diesel fuel in cold weather.

Environment

With low energy use the GHG emissions from the biodiesel plants are relatively minor. The GHG emissions of the methanol must also be included in the carbon footprint. Methanol and the process chemicals used have safety hazards associated with their use but these are well known and there are established procedures to accommodate their safe use.

Research and Development Perspective

Vegetable oil FAME is a Category 4 technology, a commercial technology with large scale deployment. The potential for significant improvements in capital and operating costs is limited. The price and performance of the technology today is well known and normally only incremental improvements would be expected. Therefore, the future price and performance may also be projected with a relatively high level of certainty.

Examples of Market Standard Technology

A number of companies provide biodiesel technology packages. Desmet Ballestra [3] is one such company.

Desmet Ballestra Group N.V.

Fountain Plaza Office Park, Building 503

Belgicastraat 3

B - 1930 ZAVENTEM

Belgium

They have been involved in over 85 plants around the world with capacity in excess of 12 million tonnes/year. Their plants have capacities from 50,000 to 300,000 tonnes per year.

Predication of Performance and Cost

Biodiesel production from vegetable oils is mature technology. Conversion performance in most plants approaches the theoretical maximum conversion rates. There is therefore limited development potential for the technology.

Worldwide production rates are about 30 billion litres per year with the cumulative production between 2000 and 2014 being 195 billion litres as shown in the following figure [4].

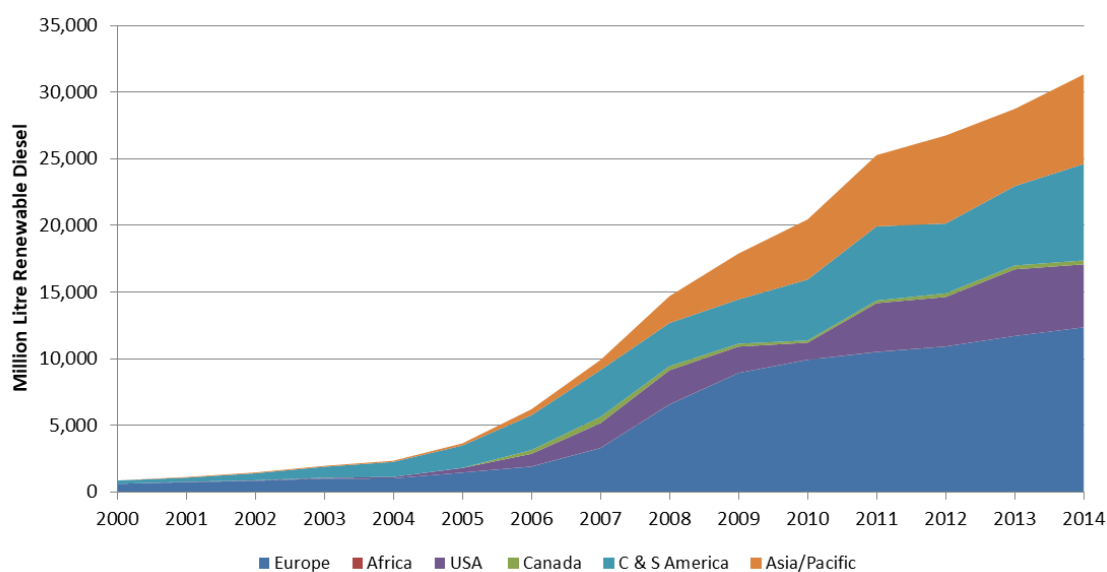

Figure 3 World Biodiesel Production

At current production rates the cumulative production since 2000 will double in six years. Berghout investigated the Progress ratio for the German Biodiesel industry between 1991 and 2004 and found that the limited data suggested a value of 0.97. This is a very low value and may be due to the fact that while the industry is new, the processing steps are based on mature chemical processes with limited potential for improvement. The cost reduction would also not apply to feedstock so the impact on production economics will be marginal.

Uncertainty

Given the mature status of the technology there are low levels of uncertainty associated with the data that is collected, but there will always be some uncertainty regarding future projections.

Additional Remarks

This technology is commercially practiced in Denmark today by Emmelev A/S. Denmark blends FAME and HVO at about 7% by energy content in diesel fuel [5]. The FAME could be from vegetable oil or from UCO.

Quantitative Description

The basic chemical reaction is depicted below. One hundred kilograms of a fat or oil is reacted with 10 kilograms of methanol in the presence of a catalyst to produce 10 kilograms of glycerine and 100 kilograms of methyl esters or biodiesel. The methanol is charged in excess to assist in quick conversion and recovered for reuse. The catalyst is usually sodium or potassium methoxide which has already been mixed with the methanol. R1, R2, and R3 indicate the fatty acid chains associated with an individual fat.

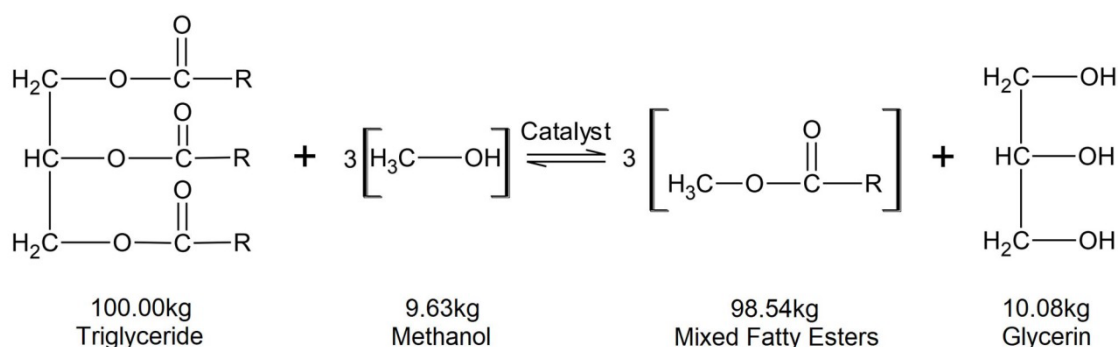

Figure 4 Basic Biodiesel Reactions

Typical Plant Size

While there has been a wide range of plants built in the past, large scale plants can enjoy some economies of scale. The one vegetable oil biodiesel plant in Denmark (Emmelev) has a production capacity of 100,000 tonnes per year [6]. This is the average plant size reported in Germany in 2010 and will be used for the data sheet.

Input and Output

The typical mass and energy balances for the primary materials and energy sources are shown in the following table. The data is from a 2016 Survey of vegetable oil biodiesel plants operating in the United States [7]. The data is from 12 plants with production capacities ranging from 40,000 to 330,000 tonnes per year. The plants operated at an average of 74% of capacity.

	Inputs	Outputs
Vegetable oil	0.893 kg	
Methanol	0.086 kg	
FAME (one litre)		0.88 kg
Glycerine		0.09 kg
Electricity	0.036 kWh	
Natural gas	0.93 MJ (LHV)	

Table 1 Mass and Energy Flows

The input and output data for future years assumes that the industry average moves towards the current best in class values.

Forced and Planned Outage

Biodiesel plants can operate continuously with limited downtime for planned maintenance. The NBB energy survey found that plants operated from about 40 to over 95% of production capacity in 2015.

The most likely reasons for forced outage are either a lack of feedstock or a lack of markets for the product.

Technical Lifetime

The first European plants were built in the 1990s and many of those are still operating more than 20 years later. Processing conditions are relatively mild with moderate pressures and temperatures for most

processes. The corrosive nature of some of the reagents (methanol, acids and bases) are well understood and manageable.

Construction Time

Large scale plants should have a typical construction time of 12 to 18 months from the start of site preparation to the beginning of production.

Financial Data

Vegetable oil FAME plants are commercial technologies with capital and operating costs that are relatively well understood. There have been relatively few FAME plants constructed in recent years as the global industry is operating at less than full capacity.

Investment Costs

Most European vegetable oil FAME plants were built a decade ago. The most recent vegetable oil biodiesel plant that has been announced is a 200,000 tonne soybean plant to be built by Cargill in Kansas, USA. The plant will be built on the site of an existing soybean crushing facility and will replace an existing soy oil refinery. The capital cost is reported to be \$90 million US\$ [8].

Converting this cost to Europe, the location factor, exchange rate, and greenfield factor is applied as shown below

$$US \text{ capital cost} \cdot \text{greenfield factor} \cdot \text{currency factor} \cdot \text{location factor}$$

$$\$90,000,000 \cdot 1.2 \cdot 0.85 \cdot 1.21 = \text{€}111 \text{ million}$$

It is estimated that a 100,000 tonne per year plant would have a capital cost of €64 million. This is \$0.66/litre, which is in the middle of the range reported by Irena [9].

Future investment costs are not expected to decline significantly as few new plants are being built. Berghout, with limited data, concluded that learning-by-upscaling to be the primary and learning-by doing the secondary driver behind reductions in specific investment costs over time for German biodiesel plants [10]. Since the same plant size has been used for the study period of 2015 to 2050 only a small reduction (~5%) in investment costs is projected by 2050.

Operating and Maintenance Costs

The production cost profile is dominated by the feedstock costs. Feedstock costs are highly variable and can increase or decrease in any given year due to the local supply and demand situation.

Iowa State University [11] maintains a biodiesel profitability model for a 100,000 tonne/year soy biodiesel plant. The 2016 data has been used and the power and natural gas costs have been adjusted to the Danish values reported in section 1.4. The capital cost has been adjusted to 64 million Euro to match the value above. The results for 2016 are shown in the following table.

Parameter	Costs (Eur/litre)
Natural gas	0.01
Methanol	0.02
Other Variable Costs	0.06
Fixed Costs	0.02
Depreciation and Interest	0.06
Total Costs ex feedstock	0.17

Table 2 Production Costs Vegetable oil FAME

The other variable costs include chemicals, power, water, repairs and maintenance, water, transportation and other costs. The fixed costs include depreciation, interest costs, labour and management, property taxes, insurance, and marketing and procurement costs.

Berghout found a very low Progress Ratio (97.4%) and a low R2 value (0.65) for the FAME processing costs, suggesting little potential for reductions in O&M costs over time.

The impact on production costs as the future industry moves towards the best practices of the existing plants is limited as gains in yield will impact the feedstock costs which are not included here; the natural gas, power and methanol costs which are a small portion of the operating costs.

Start-up Costs

The O&M costs stated in this catalogue includes start-up costs and takes into account a typical number of start-ups and shut-downs. Therefore, the start-up costs should not be specifically included in more general analyses.

Technology Specific Data

Some of the key fuel properties of biodiesel are shown in the following table.

Property	Value
Density, kg/m ³	885
LHV, MJ/kg	37.2
LHV, MJ/litre	32.7
Oxygen content	11%
Cetane number	~55
Cloud point, C	~-3

Table 3 Vegetable Oil Biodiesel Properties

Data sheet

The quantitative data reported above is summarized in the following data sheet. This information is determined from the NBB operating data for vegetable oil feedstock plants and the operating costs estimated from the Iowa State model. The best biodiesel plants operate a close to theoretical yields and methanol consumption rates, and with low energy consumption values. The 2015 data is based on the 2015 NBB data, it has been assumed that by 2050 the industry moves to have an average performance the same as the best plant in 2015. The 2020 and 2030 values are estimated from the transition from the 2015 to 2050 values.

Technology	Vegetable Oil FAME										
	2015	2020	2030	2040	2050	Uncertainty (2020)		Uncertainty (2050)		Note	Ref
						Lower	Upper	Lower	Upper		
Energy/technical data											
Typical total plant size 1,000 t biodiesel/year	100	100	100	100	100	50%	200%	50%	200%	A	1
Typical total plant size MW biodiesel	125	125	125	125	125	50%	200%	50%	200%	A1	
Inputs											
Veg Oil Consumption, MWh/MWh Total Input	0.925	0.926	0.929	0.931	0.933	99%	101%	99%	101%	E,I	4
Methanol Consumption, MWh/MWh Total Input	0.046	0.046	0.046	0.046	0.046	93%	107%	93%	107%	B,E,I	4
Electricity Consumption, MWh/MWh Total Input	0.004	0.004	0.003	0.003	0.002	50%	150%	75%	125%	E,I	4
Natural Gas Consumption, MWh/MWh Total Input	0.025	0.024	0.022	0.02	0.018	50%	150%	75%	125%	E,I	4
Outputs											
Biodiesel Output, MWh/MWh Total Input	0.903	0.903	0.903	0.903	0.903	99%	101%	99%	101%	F	4
Glycerine Output, MWh/MWh Total Input	0.039	0.039	0.039	0.039	0.039	99%	101%	99%	101%	F	4
Operational parameters											
Forced outage (%)	0	0	0	0	0					H	
Planned outage (weeks per year)	2	2	2	2	2						
Technical lifetime (years)	25	25	25	25	25						
Construction time (years)	1.5	1.5	1.5	1.5	1.5						
Financial data											
Specific investment (M € /MW)	0.51	0.50	0.50	0.49	0.48	90%	110%	90%	110%	C, J, L	
- equipment (%)	75	75	75	75	75					G	
- installation (%)	25	25	25	25	25					G	
Fixed O&M (M € /MW/year)	0.018	0.018	0.018	0.018	0.018	90%	110%	90%	110%	D, K, L	
Variable O&M (€ /MWh)	6.77	6.77	6.77	6.77	6.77	90%	110%	90%	110%	D, K, L	
Start-up (M € /MW)	0	0	0	0	0						
Technology specific data											
Specific energy content (GJ/ton) biodiesel)	37.2	37.2	37.2	37.2	37.2						
Specific density (kg/l) or (ton/m3)	0.885	0.885	0.885	0.885	0.885						
Specific investment (M € /1,000 t biodiesel/year)	0.64	0.63	0.62	0.61	0.60	90%	110%	90%	110%	C, J	
- equipment (%)	75	75	75	75	75					G	
- installation (%)	25	25	25	25	25					G	
Fixed O&M M € /1,000 t biodiesel)	0.022	0.022	0.022	0.022	0.022	90%	110%	90%	110%	D, K, L	
Variable O&M (M € /1,000 t biodiesel)	0.070	0.070	0.070	0.070	0.070	90%	110%	90%	110%	D, K, L	

Notes:

- A. The plant size is assumed based on the plants sizes of existing vegetable oil based bio-diesel plants in EU.
- A1. This value is the hourly rating and has been calculated as if the unit produces 100,000 t/year and was in operations 8,000 h/year.
- B. Energy input from supporting chemicals of minor amounts is not considered.
- C. The total capital cost include total installed cost (total direct costs) and all indirect costs such as engineering, construction, contractor's fee, contingency and working capital.
- D. O&M costs, costs for main raw materials are not included
- E. 2050 values are based on industry best plant in 2015. 2020 and 2030 values interpolated between 2015 and 2050 values.
- F. Total output excludes the heat loss.
- G. Estimated from Iowa State biodiesel profitability file.
- H. Best plants operate at greater than 95% of capacity.
- I. The uncertainty is one standard deviation from the average from the NBB survey.
- J. Range of capital cost is +/- 25% of mean.
- K. Operating cost is +/- 10% of mean.
- L. M €/k tonne is million euro per 1,000 tonnes

References

- [1] Personal Communication. 2018. T Jensen, Emmelev A/S
- [2] International Institute for Sustainable Development. 2012. Biofuels – At What Cost? Mandating ethanol and biodiesel consumption in Germany. https://www.iisd.org/gsi/sites/default/files/bf_awc_germany.pdf
- [3] Desmet Ballestra. 2015. Biodiesel. <http://www.desmetballestra.com/images/PDF-Brochures-2014/Biodiesel2015.pdf>
- [4] US Energy Information Administration. 2015. International Energy Statistics. Biofuels Production. <http://www.eia.gov/cfapps/ipdbproject/IEDIndex3.cfm?tid=79&pid=79&aid=1>
- [5] Energy Statistics 2015. https://ens.dk/sites/ens.dk/files/Statistik/energy_statistics_2015.pdf
- [6] IEA Bioenergy Task 39. Newsletter #39. Denmark Feature. <http://task39.sites.olt.ubc.ca/files/2015/06/IEA-Bioenergy-Task-39-Newsletter-Issue-39-May-2015-final.pdf>
- [7] Chen, R., Qin, Z., Han, J., Wang, M., Taheripour, F., Tyner, W., O'Connor, D., Duffield, J. 2018. Life cycle energy and greenhouse gas emission effects of biodiesel in the United States with induced land use change impacts. *Bioresource Technology*, Volume 251, 2018, Pages 249-258, ISSN 0960-8524, <https://doi.org/10.1016/j.biortech.2017.12.031>.
- [8] Cargill. 2017. Cargill to build state of- the-art biodiesel plant in Wichita, Kansas. <https://www.cargill.com/2017/cargill-to-build-state-of-the-art-biodiesel-plant-in-wichita-ks>
- [9] IRENA. 2013. Road Transport: The Cost of Renewable Solutions. http://www.irena.org/-/media/Files/IRENA/Agency/Publication/2013/Road_Transport.ashx
- [10] Berghout, Niels. (2008). Technological learning in the German biodiesel industry: An experience curve approach to quantify reductions in production costs, energy use and greenhouse gas emissions. <http://task39.sites.olt.ubc.ca/files/2013/05/Technological-learning-in-the-German-Biodiesel-Industry.pdf>

[11]Iowa State University. 2017. Biodiesel Profitability.

<http://www.extension.iastate.edu/agdm/energy/xls/d1-15biodieselpdfprofitability.xlsx>

90 UCO and Animal Fat FAME

Contact Information:

Danish Energy Agency: Jacob Hjerrild Zeuthen, jhz@ens.dk and Filip Gamborg, fgb@ens.dk

Author: Don O'Connor – (S&T)² Consultants Inc.

Publication date

August 2018

Amendments after publication date

Date	Ref.	Description
12 2018		Datasheet revised

Qualitative Description

Used Cooking Oil (UCO) and animal fats can also be used to produce FAME. This section of the report discusses FAME production using these two feedstocks. The primary technical differentiation factor for these two feedstocks is the free fatty acid (FFA) content of the feedstocks. Free fatty acids can be produced when the lipids are heated, as they are when the cooking oils are used or when the animal carcass' are rendered.

UCO and animal fats are generally less expensive feedstocks than vegetable oils. UCO is also treated as a waste material in most regulatory systems so it generates a better carbon intensity score and the volume is double counted in some systems. These attributes make it an attractive feedstock, more than outweighing some processing challenges described below.

Brief Technology Description

The base catalyzed transesterification process that produces FAME or biodiesel from vegetable oils is only effective with triglycerides. FFAs require an acid catalyzed esterification reaction for commercial production. This reaction is slower and involves an extra processing step. Some UCO and animal fat biodiesel producers accept the lower yield that results from not converting the FFAs to biodiesel and some use the two step process that converts both triglycerides and FFAs to biodiesel.

The two step process is shown below, the basic difference between this and the process used for vegetable oils is the initial esterification steps.

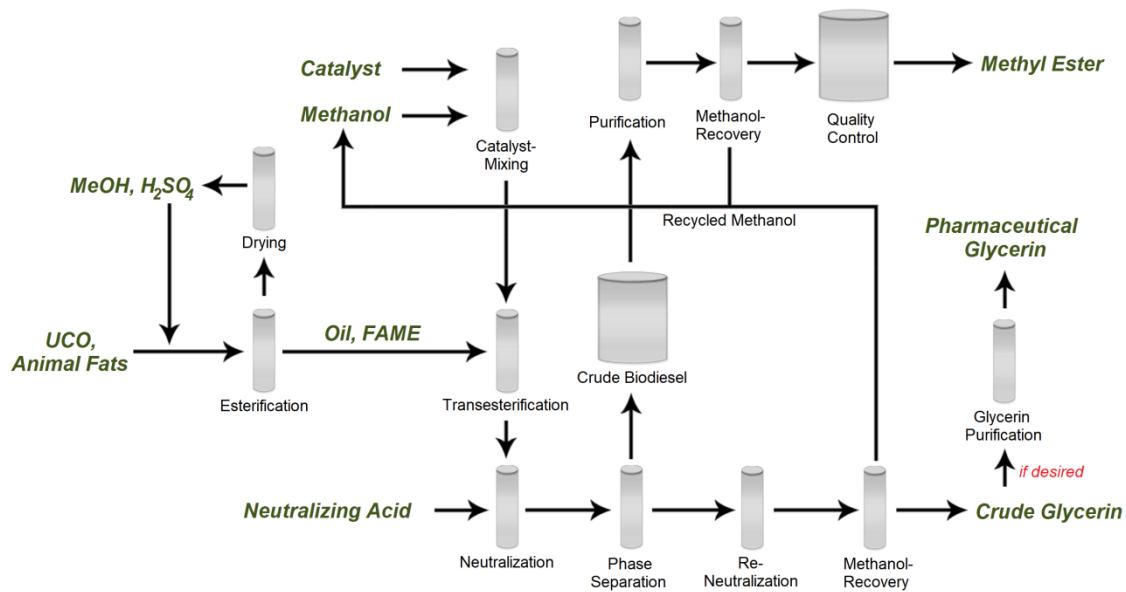

Figure 1 Two Step Biodiesel Production Process

Input

The primary inputs to the production process are the UCO or animal fat, methanol, electricity, some thermal energy, the catalyst(s), and some acids and bases to treat the feedstocks and finished products.

Output

The plants produce FAME, glycerine (of various qualities), in some cases potassium salts that can be sold as fertilizer, and unreacted FFAs.

Energy Balance

The average energy balance for the year 2015 from 15 US biodiesel plants processing mixed feedstocks is shown in the following figure [1]. Most of these plants do not do the two step process and accept the lower yield due to the higher FFA content of the feedstock.

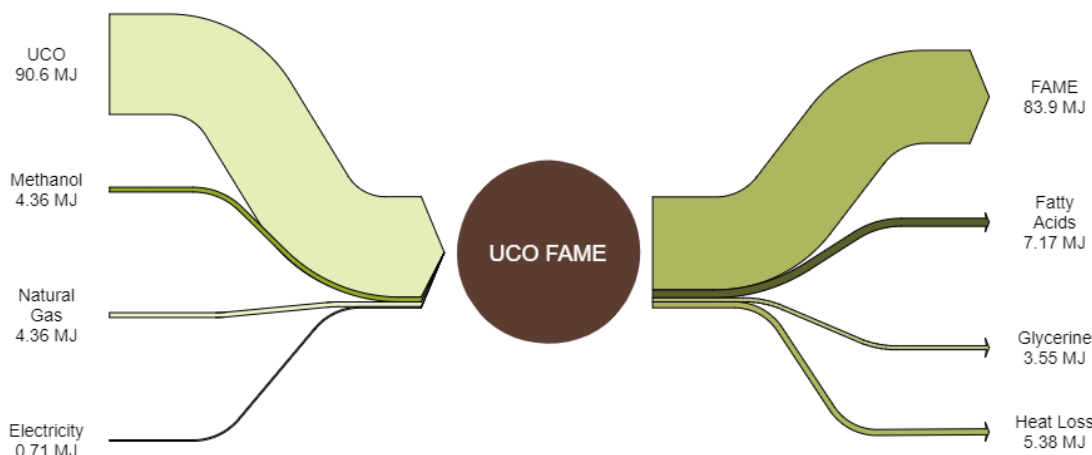

Figure 2 UCO and Animal Fat FAME Energy Balance

The potential for recovering some heat for district heating is similar to that of the vegetable oil FAME process, about 5% of the heat loss.

Typical Capacities

The size of UCO and animal fat plants is slightly smaller than the size of vegetable oil plants. Production capacities of up to 150,000 tonnes per year (185 MW) have been built in Europe.

The Daka ecoMotion plant in Denmark has a capacity of 50,000 tonnes per year (60 MW). This plant uses the two step process of esterification followed by transesterification. The plant was designed by BDI in 2008.

Regulation Ability

FAME plants can be either batch or continuous processes. The time between batches regulates the total production from batch plants. Larger plants are generally continuous processes. The throughput can be regulated to a degree but process start-up is generally fast so regulating the days of operation is also a viable means to regulate production.

Space Requirements

The Daka plant in Denmark sits on 2.1 ha of land. This is 0.038 ha/million litres or 340 m²/MW of biodiesel.

All of the materials in and out of the plant come by truck. The plant is shown in the following figure. The actual storage and processing equipment covers less than 50% of the site.



Figure 3 Daka FAME Plant

Advantages/Disadvantages

UCO and animal fats have many of the same advantages and disadvantages as vegetable oil FAME when compared to petroleum diesel fuel.

When UCO and animal fat FAME is compared to vegetable oil FAME the feedstock costs are usually lower but capital and operating costs are slightly higher. The cold weather properties of UCO and animal fat FAME are usually slightly less attractive than the vegetable oil FAME.

Environment

With low energy use the emissions from the biodiesel plants are relatively minor. Methanol and the process chemicals used have safety hazards associated with their use but these are well known and there are established procedures to accommodate their safe use.

The energy content of the UCO and animal fat biodiesel is about 20 times the power and natural gas energy consumed by the plant.

Research and Development Perspective

Used Cooking Oil (UCO) and animal fat FAME is a Category 4 technology, a commercial technology with large scale deployment. The price and performance of the technology today is well known and normally only incremental improvements would be expected. Therefore, the future price and performance may also be projected with a relatively high level of certainty.

The potential for significant improvements in capital and operating costs is limited. There is work being undertaken on making the use of lower quality feedstocks commercially attractive. These materials (e.g. brown grease) can have very high FFA levels and contain other contaminants such as sulphur and chlorine.

Examples of Market Standard Technology

One of the leaders with the multi-feedstock biodiesel process is the Austrian company, BDI Bioenergy International.

BDI - BioEnergy International AG

Parkring 18, 8074
Raaba-Grambach, Austria

They have built more than 30 biodiesel plants, mostly in Europe, since 1991.

Predication of Performance and Cost

Biodiesel production from UCO and animal fats is relatively mature technology. Conversion performance in the best plants that use the two step process approaches the theoretical maximum conversion rates. There is therefore limited development potential for the technology.

Berghout [2] investigated the Progress Ratio for the German Biodiesel industry between 1991 and 2004 and found that the limited data suggested a value of 0.97. This is a very low value and may be due to the fact that while the industry is new, the processing steps are based on mature chemical processes with limited potential for improvement. The cost reduction would also not apply to feedstock so the impact on production economics will be marginal.

Uncertainty

Given the mature status of the technology there are relatively low levels of uncertainty associated with the data that is collected. One area of potential uncertainty is the proportion of plants that practice esterification in the United States (where the plant data comes from) vs the EU.

Additional Remarks

This technology is commercially practiced at the Daka plant in Denmark. Europe is an importer of used cooking oil as demand for the product exceeds the quantity supplied in Europe [2]. It is also reported that there are limited opportunities to increase the collection rate of UCO in Europe [3], resulting in about 60% of the UCO consumed in Europe is imported into the EU.

Quantitative Description

Additional quantitative information on the production of UCO or animal fat FAME is presented in the following sections.

The esterification reaction that is practiced with some technologies prior to the transesterification process is shown below. In this reaction there is no glycerine produced but there is some water produced.

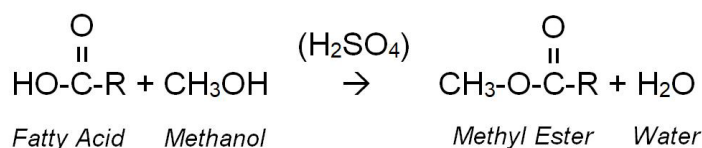

Figure 4 Esterification Reaction

Typical Plant Size

The plants can range in size from 5,000 to over 100,000 tonnes per year of capacity. Older plants generally have lower production rates as market access for the production would have been an issue when they were built.

A plant of 50,000 tonne/year is used for the data sheet. This is in the middle of the range of plants built and is the same size as the existing Danish plant.

Input and Output

The typical mass and energy balances for the primary materials and energy sources are shown in the following table. The data is from a 2016 Survey of vegetable oil biodiesel plants operating in the United States [1]. The data is from 15 plants with production capacities ranging from 3,000 to 200,000 tonnes per year. The plants operated at an average of 73% of capacity. The primary feedstocks for these plants were animal fats, distillers' corn oil (extracted from the stillage of corn ethanol plants), and used cooking oil. About 10% of the feed for these mixed feedstock plants was vegetable oils.

	Inputs	Outputs
Vegetable oil	0.977kg	
Methanol	0.087 kg	
FAME (one litre)		0.88 kg
Glycerine		0.09 kg
Electricity	0.08 kWh	
Natural gas	1.71 MJ (LHV)	

Table 4 Mass and Energy Flows

The FAME yield is lower, indicating that many of the plants do not practice the esterification step and the energy use is about double that of the vegetable oil plants. The energy use would be higher if more of the plants were batch processes rather than continuous operations.

Forced and Planned Outage

Biodiesel plants can operate continuously with limited downtime for planned maintenance. The NBB energy survey found that plants operated from about 40 to over 97% of production capacity in 2015.

The most likely reasons for forced outage are either a lack of feedstock or a lack of markets for the product.

Technical Lifetime

The first European plants were built in the 1990s and many of those are still operating more than 20 years later. Processing conditions are relatively mild with moderate pressures and temperatures for most processes. The corrosive nature of some of the reagents (methanol, acids and bases) are well understood and manageable.

Construction Time

Large scale plants should have a typical construction time of 12 to 18 months from the start of site preparation to the beginning of production.

Financial Data

Information on capital and operating costs are presented below.

Investment Costs

Argent Energy built a 75,000 tonne per year multi-feedstock facility near Chester, UK in 2015-2016. The reported cost was £75 million (€100 million) [4]. This is considerably more expensive than the recent cost estimate for a soybean biodiesel plant in the United States. The plant has significant pretreatment facilities and can reportedly process 100% FFA feedstocks. Given the extra processing required for the plants processing higher FFA feedstocks some increase in price is expected but this €1.17/litre, almost double the soy oil cost.

The future capital costs have been reduced by about 25% by 2050. The rationale for the larger percent cost reduction than a vegetable oil FAME plant is that a greater yield improvement is expected as the industry moves towards the best in class performance, due to the higher capital costs there should be more room for improvement, and there is greater emphasis being place on the use of “waste” feedstocks by many governments.

Operating and Maintenance Costs

There is no public source of economic data for UCO or animal fat biodiesel plants like the Iowa State information on soybean biodiesel plants. Given the higher energy requirements, the higher capital costs, the potentially lower yields the operating costs should be higher than they are for a vegetable oil plant.

A German biodiesel Petrotec, a UCO biodiesel producer, used to supply some financial information to their shareholders. The last information available is for 2014 [5], before they were purchased by REG Inc. from the United States. The plant has a capacity of 185,000 tonnes per year and operated at 75% capacity in 2014. The information that can be developed from the annual report is shown in the following table.

Category	Euro /litre
Services	0.05
Labour	0.05
Operating Costs	0.04
Marketing Costs	0.03
Admin Costs	0.01
Legal Costs	0.01
Other Expenses	0.01
Interest	0.01
Total	21

Table 1 UCO Biodiesel Operating Costs

The fixed costs (labour, marketing, admin, legal, other, interest) total €0.13/litre. There is no breakdown of feedstock costs from other supplies in the published information. The vegetable oil plant has variable operating costs of €0.05/litre, the chemical costs will be higher for the UCO facility, it is estimated that the variable operating costs of €0.07/litre.

As with the vegetable oil FAME plants only limited improvements in the fixed and variable production costs are forecast due to the low Progress ratio found by Berghout.

Start-up Costs

The O&M costs stated in this catalogue includes start-up costs and takes into account a typical number of start-ups and shut-downs. Therefore, the start-up costs should not be specifically included in more general analyses.

Technology Specific Data

Property	Value
Density, kg/m ³	885
LHV, MJ/kg	37.2
LHV, MJ/litre	32.7
Oxygen content	11%
Cetane number	50-60
Cloud Point, C	0-10 C

Table 2 UCO and Animal Fat Biodiesel Properties

Data sheet

The quantitative information collected for a UCO biodiesel facility is shown in the following table. This information is determined from the NBB operating data for mixed feedstock plants and the operating costs estimated from the Petrotec annual report. The best biodiesel plants operate a close to theoretical yields and methanol consumption rates, and with low energy consumption values. The 2015 data is based on the 2015 NBB data; it has been assumed that by 2050 the industry moves to have an average performance the same as the best plant in 2015. The 2020 and 2030 values are estimated from the transition from the 2015 to 2050 values.

Technology	UCO and Animal Fat FAME										
	2015	2020	2030	2040	2050	Uncertainty (2020)		Uncertainty (2050)		Note	Ref
						Lower	Upper	Lower	Upper		
Energy/technical data											
Typical total plant size 1,000 t biodiesel/year	50	50	50	50	50	50%	200%	50%	200%	A	1
Typical total plant size MW biodiesel/year	60	60	60	60	60	50%	200%	50%	200%	A1	
Inputs											
Veg Oil Consumption, MWh/MWh Total Input	0.906	0.909	0.912	0.912	0.912	99%	101%	99%	101%	E,I	1
Methanol Consumption, MWh/MWh Total Input	0.044	0.044	0.044	0.044	0.044	93%	107%	93%	107%	B,E,I	1
Electricity Consumption, MWh/MWh Total Input	0.007	0.006	0.005	0.005	0.004	50%	150%	50%	150%	E,I	1
Natural Gas Consumption, MWh/MWh Total Input	0.044	0.04	0.036	0.034	0.032	50%	50%	50%	50%	E,I	1
Outputs											
Biodiesel Output, MWh/MWh Total Input	0.84	0.85	0.86	0.86	0.87	99%	101%	99%	101%	F	1
Glycerine Output, MWh/MWh Total Input	0.04	0.04	0.04	0.04	0.04	99%	101%	99%	101%	F	1
Forced outage (%)	0	0	0	0	0					H	
Planned outage (weeks per year)	2	2	2	2	2						
Technical lifetime (years)	25	25	25	25	25						
Construction time (years)	1.5	1.5	1.5	1.5	1.5						
Financial data											
Specific investment (M € /MW)	1.08	1.02	0.93	0.89	0.84	80%	120%	90%	110%	C, J, L	3
- equipment (%)	75	75	75	75	75					G	
- installation (%)	25	25	25	25	25					G	
Fixed O&M (M € /MW/year)	0.122	0.122	0.122	0.122	0.122	90%	110%	90%	110%	D, K, L	4
Variable O&M (€ /MWh)	7.65	7.65	7.65	7.65	7.65	90%	110%	90%	110%	D, K, L	4
Start-up (M € /MW)	0.00	0.00	0.00	0.00	0.00						
Technology specific data											
Specific energy content (GJ/ton) biodiesel)	37.2	37.2	37.2	37.2	37.2						
Specific density (kg/l) or (ton/m3)	0.885	0.885	0.885	0.885	0.885						
Specific investment (M € /1,000 t biodiesel/year)	1.33	1.25	1.15	1.10	1.00	80%	120%	90%	110%		
- equipment (%)	75	75	75	75	75					G	
- installation (%)	25	25	25	25	25					G	
Fixed O&M (M € /1,000 t biodiesel)	0.15	0.15	0.15	0.15	0.15	90%	110%	90%	110%	D, K, L	
Variable O&M (M € /1,000 t biodiesel)	0.08	0.08	0.08	0.08	0.08	90%	110%	90%	110%	D, K, L	

Notes:

The plant size is assumed based on the plants sizes of existing UCO based bio-diesel plants in EU.

A1 This value is the hourly rating and has been calculated as if the unit produces 50,000 t/year and was in operations 8,000 h/year.

B. Energy input from supporting chemicals of minor amounts is not considered.

C. The total capital cost include total installed cost (total direct costs) and all indirect costs such as engineering, construction, contractor's fee, contingency and working capital.

D. O&M costs only, costs for main raw materials are not included

E. 2050 values are based on industry best plant in 2015. 2020 and 2030 values interpolated between 2015 and 2050 values.

F. Total output excludes the heat loss.

G. Estimated from Iowa State biodiesel profitability file.

H. Best plants operate at greater than 95% of capacity.

I. The uncertainty is one standard deviation from the average from the NBB survey.

J. Range of capital cost is +/- 30% of mean for 2015.

K. Operating cost is +/- 10% of mean.

L. M €/k tonne is million euro per 1,000 tonnes.

References

- [1] Chen, R., Qin, Z., Han, J., Wang, M., Taheripour, F., Tyner, W., O'Connor, D., Duffield, J. 2018. Life cycle energy and greenhouse gas emission effects of biodiesel in the United States with induced land use change impacts. *Bioresource Technology*, Volume 251, 2018, Pages 249-258, ISSN 0960-8524, <https://doi.org/10.1016/j.biortech.2017.12.031>.
- [2] Berghout, Niels. (2008). Technological learning in the German biodiesel industry: An experience curve approach to quantify reductions in production costs, energy use and greenhouse gas emissions. <http://task39.sites.olt.ubc.ca/files/2013/05/Technological-learning-in-the-German-Biodiesel-Industry.pdf>
- [3] Greenea. 2016. Waste-based feedstock and biofuels market in Europe. <https://www.greenea.com/wp-content/uploads/2016/11/Argus-2016.pdf>
- [4] The Chester Chronicle. May 19, 2016. Ellesmere Port's new £75m waste chip oil plant will power cars. <http://www.chesterchronicle.co.uk/news/chester-cheshire-news/ellesmere-ports-new-75m-waste-11352514>
- [5] Petrotec 2014 Annual Report. <http://www.equitystory.com/Download/Companies/petrotec/Annual%20Reports/DE000PET1111-JA-2014-EQ-E-00.pdf>

91 Hydrogenated Vegetable Oil / Renewable Diesel

Contact Information:

Danish Energy Agency: Jacob Hjerrild Zeuthen, jhz@ens.dk and Filip Gamborg, fgb@ens.dk

Author: Don O'Connor – (S&T)² Consultants Inc.

Publication date

August 2018

Amendments after publication date

Date	Ref.	Description
12 2018		Datasheet revised

Qualitative Description

Hydrogenated vegetable oil (HVO) is also known as renewable diesel. HVO plants use the same feedstocks that are used for FAME plants including used cooking oils and animal fats, however rather than reacting the feedstock with methanol the feedstock is reacted with hydrogen in the presence of a catalyst. The operating temperatures and pressures are higher than in FAME plants.

There are small differences in hydrogen demand between the different feedstocks that are used but the variation is generally less than what is seen between process developers and between plants so only one data sheet is presented.

The resulting product is oxygen free and has better fossil diesel blending properties. The product is generally isomerized to improve the cold weather properties of the fuel.

Brief Technology Description

HVO is a mixture of straight chain and branched paraffins – the simplest type of hydrocarbon molecules from the point of view of clean and complete combustion. Typical carbon numbers are C15 to C18. Paraffins exist also in fossil diesel fuels which additionally contain significant amounts of aromatics and naphthenics. Aromatics are not favorable for clean combustion. HVO is practically free of aromatics and its composition is quite similar to GTL and BTL diesel fuels made by Fischer Tropsch synthesis from natural gas and gasified biomass.

The general HVO production steps are shown in the following figure.

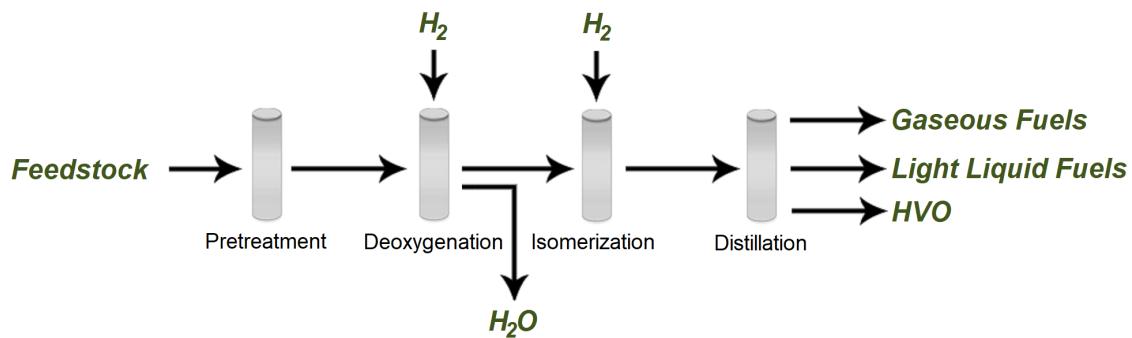

Figure 1 HVO Production Process

Almost all operating HVO plants have some degree of integration with nearby facilities to provide energy or hydrogen or to process co-product streams. This integration can reduce capital and operating costs and risks for new technologies.

Input

The primary inputs to the production process are the fats and oils and hydrogen, along with some electricity, thermal energy, and chemicals.

Output

The outputs from the process are the HVO, some fuel gas (a mixture of hydrogen and light hydrocarbons), propane, and a light liquid stream that can be used as fuel or as a renewable gasoline blending component.

Energy Balance

High quality public information on the energy balance of the HVO process is very limited. The following figure shows the typical energy balance based on a composite of information in the public domain [1] [2] [3]. The sum of the inputs totals 100 MJ.

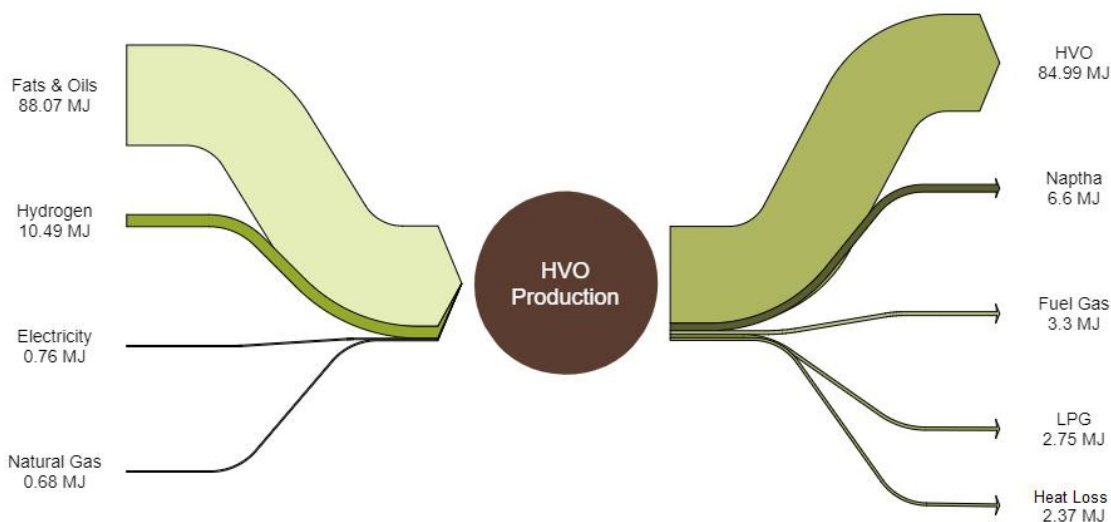

Figure 2 HVO Energy Balance

There is the potential to recover about 15% of the heat loss as high temperature heat for district heating applications.

Typical Capacities

Stand-alone HVO plants range in size from 150 million litres/year (AltAir, USA) to more than 1,000 million litres per year (Neste Singapore and Rotterdam) (170 to 1,125 MW).

Regulation Ability

Very little information is available on the turn down ratios of the process. It is a process with a high operating temperature and pressure and thus will likely have limited capacity to regulate throughputs. The existing HVO plants are generally running at capacity.

Space Requirements

The Neste plants in Singapore and Rotterdam and the Diamond Green Diesel and REG plants in Louisiana are greenfield plants that have some integration with nearby utility suppliers. The space required for the plants are in the 0.02 to 0.025 ha/million litres of production range (220 m²/MW).

Advantages/Disadvantages

HVO has a number of advantages over biodiesel as a fuel and as a production process. The process is not restricted by the free fatty acid content of the feedstock and most plants process a wide range of feedstocks from vegetable oils to UCO and animal fats.

HVO can be blended with petroleum diesel fuel without any limit or labelling requirements because it is a hydrocarbon. HVO has a higher cetane value than biodiesel and can be produced with better cold weather properties as a result of the secondary isomerization step in the process. Isomerization is also known as dewaxing. This step is often, but not always, included in HVO process designs.

The fuel is sulphur free and has very low aromatics content (although this can cause issues with some engine seals).

The market price of HVO is higher than that of biodiesel and of petroleum diesel.

Environment

The process has a low ratio of energy consumed to fuel produced (~0.02) excluding the hydrogen but drops to about 0.15 when the hydrogen energy is considered.

The hydrotreating catalysts have a long life and can be re-generated. There is limited waste generated as part of the process, although this can depend on the feedstock and the need to pre-treat the feedstock to remove minor contaminants.

Research and Development Perspective

Hydrogenated vegetable oil (HVO) is a Category 4 technology, a commercial technology with large scale deployment. While there are fewer HVO facilities in the world compared to FAME facilities, the basic processing technology have been practiced for many years in petroleum refineries. The price and performance of the technology today is well known and normally only incremental improvements would be expected. Therefore, the future price and performance may also be projected with a relatively high level of certainty.

Examples of Market Standard Technology

The leading commercial supplier of the technology is Honeywell UOP. Their corporate office is:

UOP World Corporate Offices

25 E. Algonquin Road (Bldg A)
P.O. Box 5017
Des Plaines, IL 60017-5017
Toll Free: +1 (800) 877-6184
Phone: +1 (847) 391-2000

They have a European office at

Noorderlaan 147
B-2030 Antwerp, Belgium
Phone: +32-3-540-9911

Haldor Topsøe offers their HydroFlex™ technology. Topsøe has been researching and developing innovative solutions for renewable fuel production since 2004. They claim that many licensed HydroFlex™ units are in full operation today.

Haldor Topsøe A/S

Haldor Topsøes Allé 1
DK-2800

Kgs. Lyngby
Denmark

Neste and REG have developed their own technology and have not sold it to any other producers at this time.

Predication of Performance and Cost

The production of HVO from triglycerides is a commercial technology that is deployed at scale. Only small incremental improvements on performance can be expected in the future. The current price and performance information presented has a relatively high level of certainty, although with a limited number of participants in the sector much of the information is considered confidential by the producers.

Future capital costs can be expected to improve as the plant size increases, however the future inputs and outputs are expected to be very stable due to the high levels of performance of the existing facilities. These assumptions are confirmed by the work of de Jong [4] who determined that the technology had a high capital growth factor indication a small difference between the capital costs of the pioneering plants and the nth plant.

Uncertainty

There are relatively low levels of uncertainty with respect to this pathway as it is a commercially available process. However, only a limited number of companies throughout the world offer this technology. With exception of Neste, these companies provide little information on their operations.

Additional Remarks

As noted above Neste does provide some information on the performance of their renewable products division as part of their quarterly financial reporting [5]. The reported HVO revenue is their world-wide average value. The following figure is developed from those reports and benchmark price data on diesel fuel and biodiesel reported by the US Energy Information Administration [6] and Iowa State University [7].

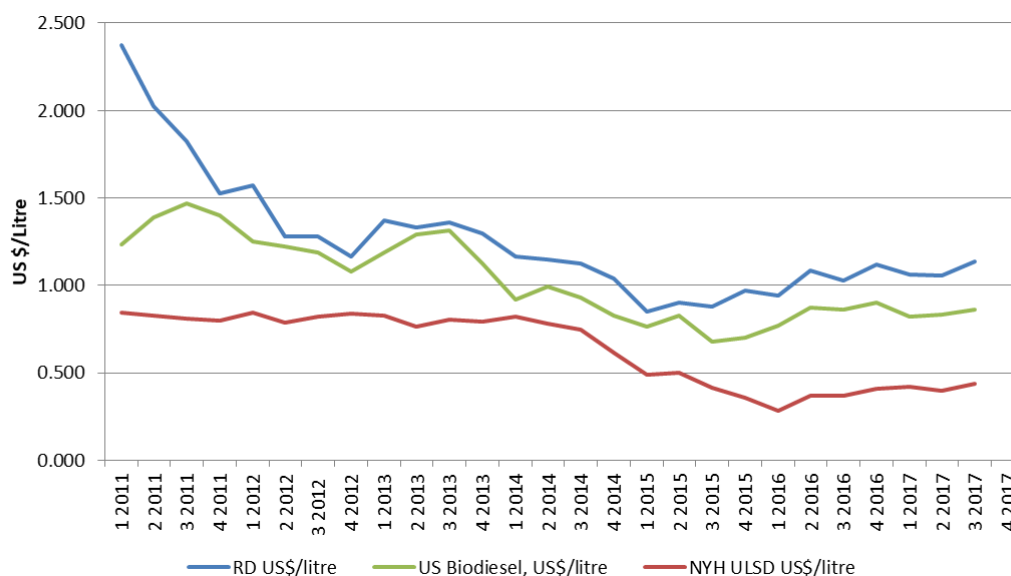

Figure 3 HVO Selling Prices vs Biodiesel and Fossil Diesel

RD, biodiesel and ULSD represents selling prices for HVO, FAME biodiesel and ultra low sulphur diesel, respectively.

Quantitative Description

The quantitative data is presented below for the technology. The HVO chemistry is shown in the following figure [8].

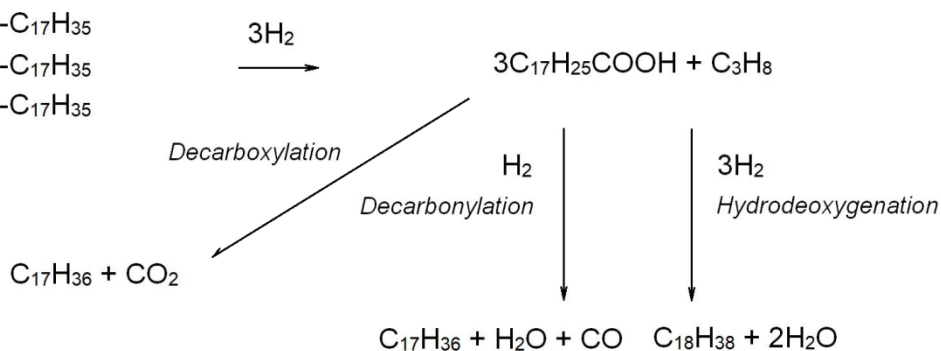

Figure 4 HVO Chemistry

The oxygen from the triglyceride feedstock is removed as CO, CO₂ and some as H₂O. Unlike an ethanol plant the CO₂ is not available as a concentrated co-product stream. Some of the feedstock is also converted to propane and because there is some cracking of the chains a portion of the liquid product is in the jet fuel or gasoline pool boiling range.

Typical Plant Size

There is almost an order of magnitude difference between the output of the smallest plant and the largest plants. It is assumed that the typical plant size will be in the middle of the range at 500,000 tonne per year of primary product (640 million litres per year).

Input and Output

The input and output data shown in the following table is the same information used for the energy balance shown in Figure 2. It is typical data and not representative of any specific plant. The output is one litre of HVO.

	Inputs	Outputs
Feedstock	0.97 kg	
Hydrogen	0.035 kg	
Natural gas	0.27 MJ	
Electricity	0.085 kWh	
Fuel gas		0.03 kg
LPG		0.025 kg
Naphtha		0.06 kg
HVO (one litre)		0.77 kg

Table 1 Mass and Energy Flows HVO

Forced and Planned Outage

Neste report their quarterly sale rates. Since the last quarter of 2011, the plants in Finland, Singapore, and Rotterdam have been operational with an original nameplate capacity of 500,000 tonne per quarter. Neste now claims a quarterly production capacity of 650,000 tonnes. The sales performance is shown in the following figure and it is assumed that the production rates closely follow the sales rates. Since 2013 the plants have operated above the original nameplate capacity indicating minimal unplanned outages.

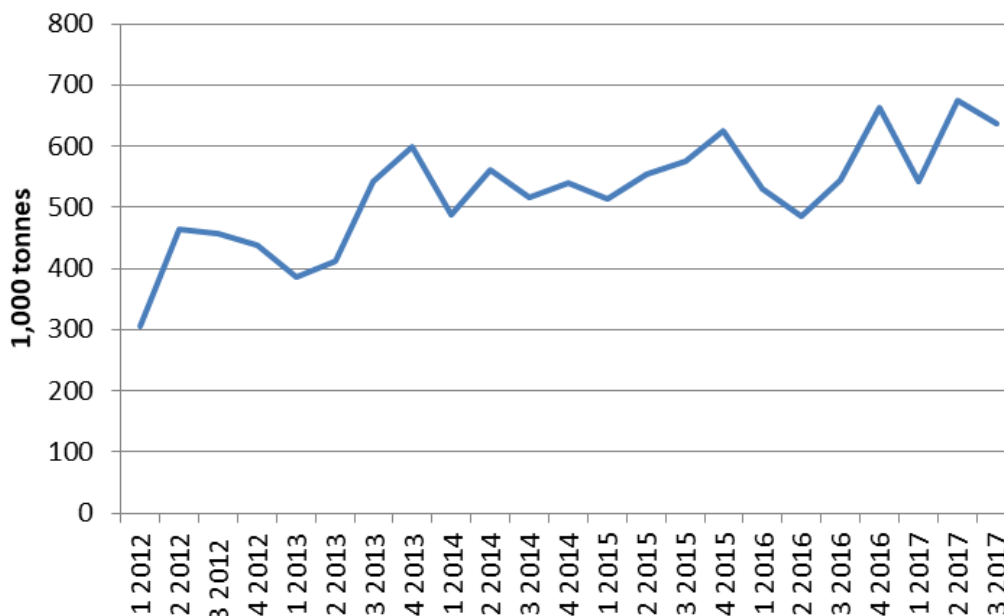

Figure 5 Quarterly Performance – Neste HVO

Neste report that the plants undergo a major turnaround lasting 8 weeks every four to five years. This is equivalent to 15 days per year.

Technical Lifetime

Plant lifetimes should exceed 25 years, similar to what would be expected in a petroleum refinery.

Construction Time

Construction time of 24 to 30 months should be expected. This is longer than a FAME plant but the HVO plants are generally larger and have process vessels that operate at higher pressures and temperatures with an expectation of longer fabrication periods.

Financial Data

Financial data from public data sources is presented below. Where primary public data is not available two peer reviewed techno-economic analyses have been used [9] [10].

Investment Costs

Diamond Green Diesel is undergoing a 330,000 tonne/year expansion in Louisiana. The reported cost is \$190 million (US) [10]. They reported that this was about 50% of the cost of a greenfield plant.

Converting this cost to Europe, the location factor, exchange rate, and greenfield factor is applied as shown below.

$$US \text{ capital cost} \cdot \text{greenfield factor} \cdot \text{currency factor} \cdot \text{location factor}$$

$$\$190,000,000 \cdot 2.0 \cdot 0.85 \cdot 1.21 = \text{€}390 \text{ million}$$

It is estimated that a 500,000 tonne per year plant would have a capital cost of €550 million using a scaling factor of 0.8. This corresponds to €0.86/litre.

The EU Sub Group on Advanced Biofuels [12] reported that the capital costs for a 500,000 tonne/year plants would be between 192 and 577 million Euros. The Diamond Green data would be at the upper end of the range.

A one million tonne per year plant is expected to cost $2^{0.6}$ times (1.5) that of the 500,000 tonne per year plant or 0.65 €/litre. This value is used for the 2050 capital cost. The same approach is used for the 750,000 tonne plant in 2030.

Operating and Maintenance Costs

Neste publishes some information on their production costs in their quarterly financial reports. The available information for 2016 is shown in the following table.

Item	Value	
	€/tonne	€/litre
Revenue,	1,211	0.93
Variable production costs	117	0.09
Fixed Costs	58	0.04
Depreciation	50	0.04
EBIT	21	0.02
Implied Feedstock costs	876	0.67

Table 2 HVO Operating Costs

Operating costs are not expected to change over time due to the high efficiency level of the current technology. The variable operating costs are reduced by 0.01 €/litre to account for the energy costs that would be included in the reported variable costs.

Start-up Costs

The start-up costs are included in the Neste financial information.

Technology Specific Data

The physical properties of HVO are shown in the following table [13].

Property	Value
Density, kg/m ³	770
LHV, MJ/kg	44.1
LHV, MJ/litre	34.4
Oxygen content	0
Cetane number	>70
Cloud point, C	As low as -40 °C ³

Table 3 HVO Properties

³ Lower cloud points sacrifice some product yield.

Data sheet

The available data is summarized in the following table.

Technology	HVO										
	2015	2020	2030	2040	2050	Uncertainty (2020)		Uncertainty (2050)		Note	Ref
						Lower	Upper	Lower	Upper		
Energy/technical data											
Typical total plant size 1,000 t HVO/year	500	500	750	850	1000	50%	200%	50%	100%	A, B	
Typical total plant size MW HVO	730	730	1100	1250	1460	50%	200%	50%	100%	A, A1, B	
Inputs											
Feedstock Consumption, MWh/MWh Total Inputs	0.881	0.881	0.881	0.881	0.881	99%	101%	99%	101%	C	3,4,11
Hydrogen Consumption, MWh/MWh Total Inputs	0.105	0.105	0.105	0.105	0.105	93%	107%	93%	107%	C, D	3,4,11
Electricity Consumption, MWh/MWh Total Inputs	0.008	0.008	0.008	0.008	0.008	50%	150%	50%	150%	C	3,4,11
Natural Gas Consumption, MWh/MWh Total Inputs	0.007	0.007	0.007	0.007	0.007	50%	50%	50%	50%	C	3,4,11
Outputs											
HVO Output, MWh/MWh Total Input	0.850	0.850	0.850	0.850	0.850	99%	101%	99%	101%	C, H	
Naphtha Output, MWh/MWh Total Input	0.066	0.066	0.066	0.066	0.066	99%	101%	99%	101%	C, H	
Fuel Gas Output, MWh/MWh Total Input	0.033	0.033	0.033	0.033	0.033	99%	101%	99%	101%	C, H	
LPG Output, MWh/MWh Total Input	0.028	0.028	0.028	0.028	0.028	99%	101%	99%	101%	C, H	
District Heating Output, MWh/MWh Total input	0.004	0.004	0.004	0.004	0.004	99%	101%	99%	101%	C, H	
Forced outage (%)	0	0	0	0	0					I	
Planned outage (weeks per year)	2	2	2	2	2						7
Technical lifetime (years)	25	25	25	25	25						
Construction time (years)	2	2	2	2	2						
Financial data											
Specific investment (M € /MW)	0.76	0.76	0.64	0.60	0.58	90%	110%	90%	110%	E, J, L	10, 12
- equipment (%)	75	75	75	75	75						
-installation (%)	25	25	25	25	25						
Fixed O&M (M € /MW/year)	0.036	0.036	0.035	0.035	0.036	90%	110%	90%	110%	F, K, L	7
Variable O&M (€ /MWh)	8.48	8.48	8.48	8.48	8.48	90%	110%	90%	110%	F, K, L	7
Startup (M € /MW)	0	0	0	0	0						
Technology specific data											
Specific energy content (GJ/ton)	44.1	44.1	44.1	44.1	44.1						
Specific density (kg/l) or (ton/m ³)	0.77	0.77	0.77	0.77	0.77						
Specific investment (M € /1,000 t HVO)	1.12	1.10	0.94	0.88	0.84	90%	110%	90%	110%	E, J, L	10, 12
- equipment (%)	75	75	75	75	75						
-installation (%)	25	25	25	25	25						
Fixed O&M (M € /1,000 t HVO)	0.052	0.052	0.052	0.052	0.052	90%	110%	90%	110%	F, K, L	7

Variable O&M (M € /1,000 t HVO)	0.104	0.104	0.104	0.104	0.104	90%	110%	90%	110%	F, K, L	7
Startup (M € /1,000 t HVO)	0	0	0	0	0						

Notes:

- A. The plant size is assumed based on the plants sizes of existing HVO plants.
- A1. This value is the hourly rating and has been calculated as if the unit produces at capacity and was in operations 8,000 h/year.
- B. The plant size uncertainty represents the current range in the market.
- C. Performance is typical based on public data and confidential data reviewed by (S&T)² Consultants Inc.
- D. Hydrogen consumption is also a function of the feedstock to a small degree.
- E. The total capital cost include total installed cost (total direct costs) and all indirect costs such as engineering, construction, contractor's fee, contingency and working capital.
- F. O&M costs, costs for main raw materials are not included.
- G. There is limited potential for process improvements.
- H. Total output excludes the heat loss.
- I. Best plants operate at greater than 95% of capacity.
- J. Range of capital cost is +/- 25% of mean.
- K. Operating cost uncertainty is +/- 10% of mean.
- L. M €/k tonne is million euro per 1,000 tonnes

References

- [1] Neste. 2013. North American Tallow Pathway Description. <https://www.arb.ca.gov/fuels/lcfs/2a2b/apps/nes-na-tallow-rpt-011414.pdf>
- [2] US EPA. 2017. EPA Approval for REG Geismar. <https://www.epa.gov/sites/production/files/2017-05/documents/reg-geismar-deter-ltr-2017-04-13.pdf>
- [3] Kalnes, T et al. 2012. Green diesel production by hydrotreating renewable feedstocks. <https://www.uop.com/wp-content/uploads/2012/12/UOP-Hydrotreating-Green-Diesel-Tech-Paper.pdf>
- [4] de Jong, S., Hoefnagels, R., Faaij, A., Slade, R., Mawhood, R. and Junginger, M. 2015. The feasibility of short-term production strategies for renewable jet fuels – a comprehensive techno-economic comparison. *Biofuels, Bioprod. Bioref.*, 9: 778–800. <https://www.doi.org/10.1002/bbb.1613>
- [5] Neste Financial Statements. <https://www.neste.com/en/corporate-info/investors/financials>
- [6] US Energy Information Administration. New York Harbour ULSD Price. https://www.eia.gov/dnav/pet/pet_pri_spt_s1_d.htm
- [7] Iowa State University. 2017. Biodiesel Profitability. <http://www.extension.iastate.edu/agdm/energy/xls/d1-15biodieselprofitability.xlsx>
- [8] Rogelio Sotelo-Boyás, Fernando Trejo-Zárraga and Felipe de Jesús Hernández-Loyo (2012). Hydroconversion of Triglycerides into Green Liquid Fuels, Hydrogenation, Prof. Iyad Karamé (Ed.), InTech, DOI: 10.5772/48710. Available from: <https://www.intechopen.com/books/hydrogenation/hydroconversion-of-triglycerides-into-green-liquid-fuels>
- [9] Tao, L., Milbrandt, A., Zhang, Y. and Wang, W. 2017. Techno-economic and resource analysis of hydroprocessed renewable jet fuel. *Biotechnology for Biofuels* 2017 10:261. <https://doi.org/10.1186/s13068-017-0945-3>

- [10] Miller, P., Kumar, A. 2014. Techno-economic assessment of hydrogenation-derived renewable diesel production from canola and camelina, In Sustainable Energy Technologies and Assessments, Volume 6, 2014, Pages 105-115, ISSN 2213-1388, <https://doi.org/10.1016/j.seta.2014.01.008>
- [11] Diamond Green Diesel. Press release. 2016. <https://www.prnewswire.com/news-releases/diamond-green-diesel-to-be-expanded-to-275-million-gallons-annually-300248085.html>
- [12] Neste Renewable Diesel Handbook. https://www.neste.com/sites/default/files/attachments/neste_renewable_diesel_handbook.pdf
- [13] Sub Group on Advanced Biofuels. 2017. Cost of Biofuel. http://platformduurzamebiobrandstoffen.nl/wp-content/uploads/2017/07/2017_SGAB_Cost-of-Biofuels.pdf

92 HVO Jet Fuel

Contact Information:

Danish Energy Agency: Jacob Hjerrild Zeuthen, jhz@ens.dk and Filip Gamborg, fgb@ens.dk

Author: Don O'Connor – (S&T)² Consultants Inc.

Publication date

August 2018

Amendments after publication date

Date	Ref.	Description
12 2018		Datasheet revised

Qualitative Description

This technology is very similar to the HVO renewable diesel process with one exception, in addition to the isomerization step there is a hydro-cracking step to produce products in the jet fuel boiling range rather than the diesel fuel range. This can be seen in the following figure which is a comparison of the UOP process diagrams for both technologies.

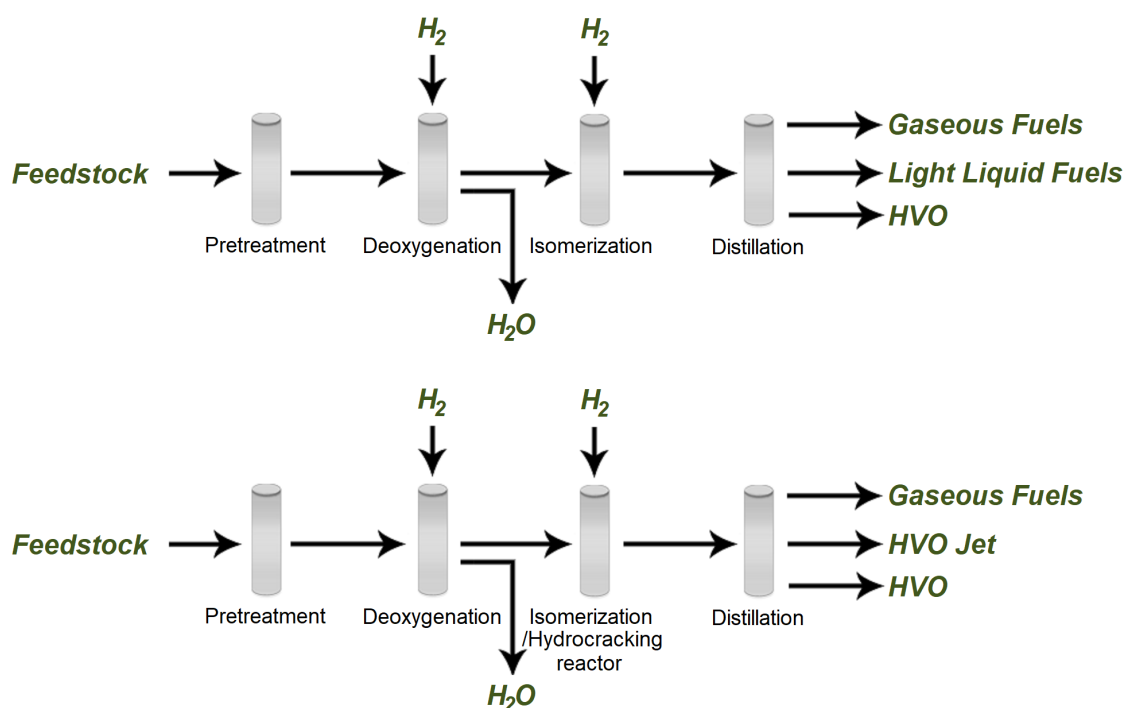

Figure 1 HVO Diesel vs Jet Process

There is one dedicated HVO jet facility in the world. It is the 130,000 tonne per year AltAir plant in Los Angeles, California. It employs the UOP process shown above. Detailed information on the AltAir operations is not

publicly available and thus there is more reliance on secondary information in the description than there was for the previous section that considered the production of renewable diesel fuel.

This technology would be classified as being between the Pioneering and the Early Commercial phase.

Brief Technology Description

To meet the jet fuel specification, the produced bio-jet fuel has to have not only a high flash point, but also good cold flow properties. Therefore, it is required to hydro-isomerize and hydrocrack the normal paraffins produced from deoxygenation to a product with carbon chains ranging from C₉ to C₁₅. The hydrocracking stage results in some yield loss of jet and diesel fuel with increased production of naphtha and fuel gas.

The AltAir facility produces Renewable F-76 (a marine distillate fuel) and JP-5 (a military jet fuel) for the US military and Renewable Jet, Diesel, and Gasoline [1]. The company has not provided information on what percentage of each fuel is produced. The facility is using animal fats and used cooking oil as feedstocks. The technology should work for any of the same oils and fats used for renewable diesel fuels.

Compared to the HVO for diesel fuel described in the previous section, the yield of jet and diesel fuel is expected to be lower and the hydrogen demand higher when jet fuel is produced as a result of the additional hydrocracking step.

Like most of the operating HVO plants, the AltAir facility takes advantage of existing equipment and services to reduce costs and risks.

Input

The primary inputs to the production process are the fats and oils and hydrogen, along with some electricity, thermal energy, and chemicals.

Output

The outputs from the process are the jet fuel, some diesel fuel, some fuel gas (a mixture of hydrogen and light hydrocarbons), propane, and a light liquid stream that can be used as fuel or as a renewable gasoline blending component.

Energy Balance

Several of the analysis of HVO Jet fuel have used the GREET model data for the energy balance [2] [3]. Other studies have investigated the optimization of the process and reported significant process variability [4] [5].

The energy balance using the GREET information is shown in the following figure.

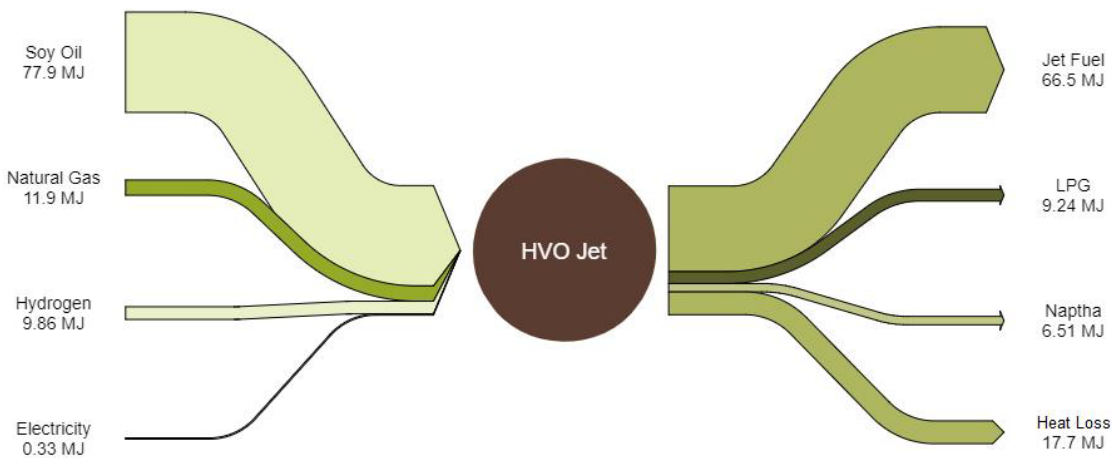

Figure 2 HVO Jet Fuel Energy Balance

As with the HVO technology in the previous chapter it is likely that 15% of the heat loss can be recovered as a high temperature stream that could be used for district heating.

The product yields for two feedstocks in the Tao paper [4], which are derived from Aspen modelling, are very different than the GREET product yields as shown in the following figure. Different product yields will impact the energy balance for the process.

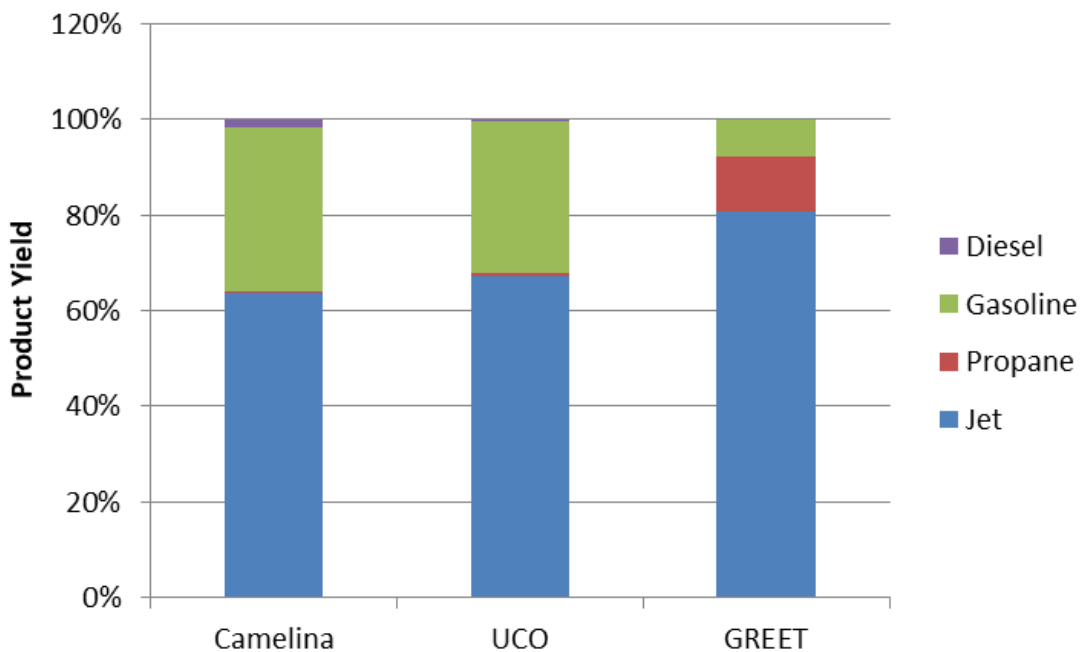

Figure 3 Comparison of Product Yields

An earlier analysis of the process published in 2010 also showed much lower yields than is used in GREET [6]. This report was based on a theoretical analysis of the process. The energy balance from this work is shown in the following figure.

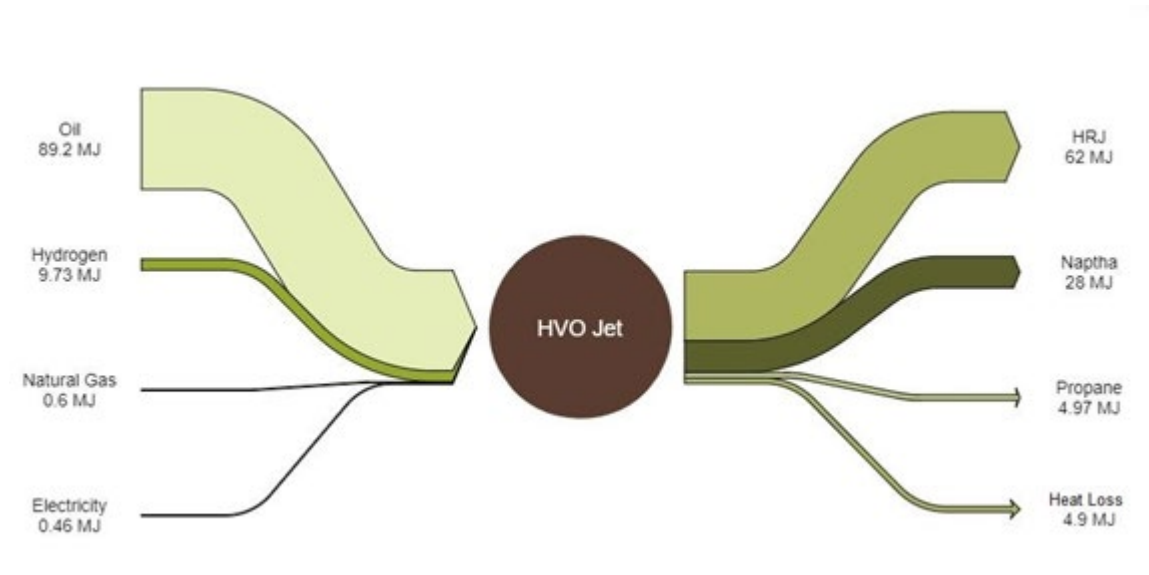

Figure 4 Alternative HVO Jet Energy Balance

Typical Capacities

Demand for biojet fuel is potentially much larger than the capacity of the single plant supplying the product. The one existing plant is also small compared to the HVO plants producing diesel fuel. There is no reason why the typical plant capacities won't be similar to the HVO for diesel plants, 150 to 1,000 million litres per year.

Regulation Ability

Very little information is available on the turn down ratios of the process. It is a process with a high operating temperature pressure and thus will likely have limited capacity to regulate throughputs.

Space Requirements

The AltAir plant is a re-purposed oil refinery so the space requirements for this facility are not likely to be representative of greenfield plants.

The Neste HVO plants in Singapore and Rotterdam and the Diamond Green Diesel and REG plants in Louisiana are greenfield plants that have some integration with nearby utility suppliers. The space required for the plants are in the 0.02 to 0.025 ha/million litres of production range (220 m²/MW). This is likely to be the same space requirements of a HVO jet plant.

Advantages/Disadvantages

HVO Jet Fuel is the only commercial process for the production of renewable jet fuel. It is fully approved up to 50% blend level with fossil jet fuel. Most of the commercial biojet flights operating in the world today use fuel from this process.

Due to lower yields and higher energy and hydrogen consumption the production costs of HVO Jet will be higher than HVO diesel fuel, which are already higher than the fossil fuel prices.

Environment

Based on the information in the peer reviewed literature the jet fuel production is more energy intensive than the production of HVO diesel fuel.

The hydrotreating catalysts have a long life and can be re-generated. There is limited waste generated as part of the process, although this can depend on the feedstock and the need to pre-treat the feedstock to remove minor contaminants.

Research and Development Perspective

Hydrogenated vegetable oil (HVO) Jet Fuel has been classed as a Category 3 technology, a commercial technology with development potential. There is one production facility in operation that is dedicated to maximize jet fuel. These technologies are deemed to have a certain development potential such as opportunities for optimizing jet fuel production with different feedstocks or possibly feedstock blends and therefore there is a considerable level of uncertainty related to future price and performance. On the other hand the process steps that are used are all well know refinery process units which limits the potential improvements.

Examples of Market Standard Technology

The leading commercial supplier of the technology is Honeywell UOP. Their corporate office is:

UOP World Corporate Offices

25 E. Algonquin Road (Bldg A)
P.O. Box 5017
Des Plaines, IL 60017-5017
Toll Free: +1 (800) 877-6184
Phone: +1 (847) 391-2000

They have a European office at

Noorderlaan 147
B-2030 Antwerp, Belgium
Phone: +32-3-540-9911

Predication of Performance and Cost

The production of jet fuel from fats and oils is being practised commercially in one facility, however very little information on the actual performance is available in the public domain. Therefore it is uncertain where the technology sits on the development curve.

Uncertainty

There are relatively high levels of uncertainty with the performance parameters for this technology as the data in the public domain is not based on the performance of the one operating plant. That information is confidential. The information that is in the public domain from peer reviewed studies is sometimes contradictory especially with respect to product yields and energy consumption.

Additional Remarks

It is possible to produce some jet fuel from HVO plants that focus on the production of diesel fuel. There is a portion of the HVO that can be recovered by distillation that will meet the fuel specifications of the jet fuel. This is the “light” end of the diesel HVO and removing it makes the remaining product heavier. However, if there is a demand for diesel and jet fuel it is one way to produce HVO Jet without a loss of yield and large amounts of LPG or naphtha materials being produced. The distillation curves for three commercial renewable diesel fuels are compared to the typical upper and lower limit for jet fuel in the following figure. It can be seen that 10 to 20% of the HVO diesel fuel is within the jet fuel range. There is no quantitative public information on the flexibility of the operations to alter the diesel/jet fuel ratios.

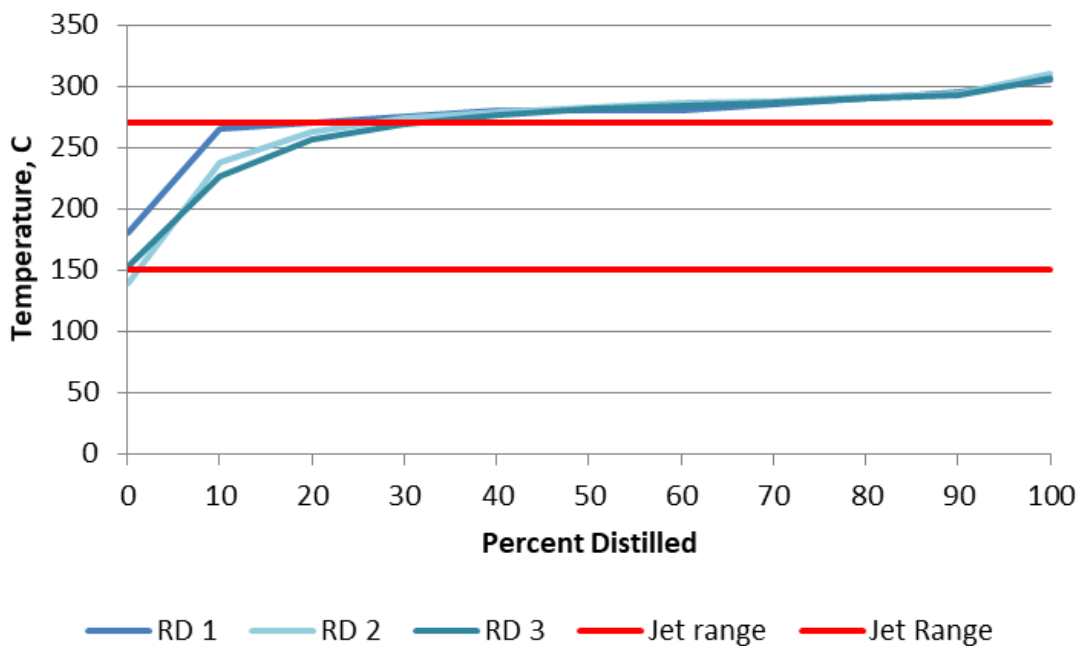

Figure 5 Renewable Diesel Distillation Curves

Quantitative Description

There is very little actual data available on this process in the public domain. The information in the peer reviewed literature is often contradictory so much of the information presented below has a high degree of uncertainty.

Typical Plant Size

The output of the primary product will be 20 to 40% lower in a jet HVO plant compared to one that produced diesel fuel. The co-product output however will be higher. It is assumed that the typical plant size will be 400,000 tonnes, 80% of the typical diesel HVO plant reflecting the lower primary product yield.

Input and Output

The estimated input and output is shown in the following table. This is based on the GREET model parameters which were used for Figure 2. The output is one litre of HVO jet fuel.

	Inputs	Outputs
Feedstock	1.07 kg	
Hydrogen	0.035 kg	
Natural gas	6.06 MJ	
Electricity	0.048 kWh	
LPG		0.142 kg
Naphtha		0.097 kg
HVO Jet (one litre)		0.77 kg

Table 1 Mass and Energy Flows HVO Jet

It has been assumed that no changes to the inputs and outputs are achieved over the present technology. The data in the table represents a very good mass balance with limited opportunity for improvement.

Forced and Planned Outage

HVO jet fuel plants should operate in a similar manner to HVO diesel fuel plants. Forced shutdowns should be minimal and longer turnaround should happen every four years with an annual rate of 15 days per year.

Technical Lifetime

Plant lifetimes should exceed 25 years, similar to what would be expected in a petroleum refinery.

Construction Time

Construction time of 24 to 30 months should be expected. This is longer than a FAME plant but the HVO plants are generally larger and have process vessels that operate at higher pressures and temperatures with an expectation of longer fabrication periods.

Financial Data

The financial data has been estimated based on the available information for HVO plants and the process differences to produce jet fuel instead of diesel fuel.

Investment Costs

Investment costs are 25% higher than the HVO plant due to the lower yield of the primary product. It is estimated that a 400,000 tonne per year plant would have a capital cost of €550 million. This is the same cost but lower throughput than used for the HVO plant. This is €1.06/litre.

De Jong [7] reported a range of capital costs of €200 to 644 million for a 350,000 tpy HVO Jet plant. This is €0.57 to €1.84 per litre.

The future investment cost is lower due to the increased scale of the plants, the same approach is used as was used for the HVO plants, a scaling factor of 0.6 is applied to the ratio of the plant size in the future to the current plant size.

Operating and Maintenance Costs

The operating and maintenance costs will be allocated across the jet fuel and the co-products. It is assumed that they will be the same per litre as were determined for the HVO plant.

The fixed O&M costs are €0.04 per litre and the variable O&M costs are €0.08 per litre. These costs are held constant for the future years.

Start-up Costs

The start-up costs are included in the operating costs.

Technology Specific Data

The physical properties of HVO Jet are shown in the following table.

Property	Value
Density, kg/m ³	770
LHV, MJ/kg	44.0
LHV, MJ/litre	34.4
Oxygen content	0
Freezing point, C	-63 °C

Table 2 HVO Jet Properties

Data sheet

The quantitative data for HVO jet fuel is summarized in the following table.

Technology	HVO Jet Fuel										
	2015	2020	2030	2040	2050	Uncertainty (2020)		Uncertainty (2050)		Note	Ref
						Lower	Upper	Lower	Upper		
Energy/technical data											
Typical total plant size 1,000 t HVO/year	400	400	600	700	800	50%	200%	50%	100%	A, B	
Typical total plant size MW HVO	580	580	875	1020	1165	50%	200%	50%	100%	A, A1, B	
Inputs											
Feedstock Consumption, MWh/MWh Total Inputs	0.779	0.779	0.779	0.779	0.779	90%	110%	90%	110%	C, G	2,3
Hydrogen Consumption, MWh/MWh Total Inputs	0.099	0.099	0.099	0.099	0.099	90%	110%	90%	110%	C,D, G	2,3
Electricity Consumption, MWh/MWh Total Inputs	0.003	0.003	0.003	0.003	0.003	90%	110%	90%	110%	C, G	2,3
Natural Gas Consumption, MWh/MWh Total Inputs	0.119	0.119	0.119	0.119	0.119	90%	110%	90%	110%	C, G	2,3
Outputs											
HVO Jet Output, GJ/GJ Total Input	0.66	0.66	0.66	0.66	0.66	90%	110%	90%	110%	C, H	
Naphtha Output, MWh/MWh Total Input	0.065	0.065	0.065	0.065	0.065	90%	110%	90%	110%	C, H	
LPG Output, MWh/MWh Total Input	0.092	0.092	0.092	0.092	0.092	90%	110%	90%	110%	C, H	
Fuel Gas Output, MWh/MWh Total Input	0.100	0.100	0.100	0.100	0.100	90%	110%	90%	110%	C, H	
District Heating Output, MWh/MWh Total input	0.027	0.027	0.027	0.027	0.027	90%	110%	90%	110%	C, H	
Operational data											
Forced outage (%)	0	0	0	0	0					I	
Planned outage (weeks per year)	2	2	2	2	2						
Technical lifetime (years)	25	25	25	25	25						
Construction time (years)	2	2	2	2	2						
Financial data											
Specific investment (M € /MW HVO Jet)	0.96	0.96	0.81	0.75	0.71	50%	150%	50%	150%	A, E, J, L	
- equipment (%)	75	75	75	75	75						
-installation (%)	25	25	25	25	25						
Fixed O&M (M € /MW/year)	0.036	0.036	0.036	0.036	0.036	90%	110%	90%	110%	F, K, L	
Variable O&M (€ /MWh)	8.501	8.501	8.501	8.501	8.501	90%	110%	90%	110%	F, K, L	
Start-up (M € /1,000 t HVO Jet)	0	0	0		0						
Technology specific data											
Specific energy content (GJ/ton)	44	44	44	44	44						
Specific density (kg/l) or (ton/m3)	0.77	0.77	0.77	0.77	0.77						
Specific investment (M € /1000 t HVO Jet)	1.39	1.39	1.18	1.10	1.04	50%	150%	50%	150%	A, E, J, L	
-equipment (%)	75	75	75	75	75						
-installation (%)	25	25	25	25	25						
Fixed O&M (M € /1,000 t HVO)	0.052	0.052	0.052	0.052	0.052	90%	110%	90%	110%	F, K, L	
Variable O&M (M € /1,000 t HVO)	0.104	0.104	0.104	0.104	0.104	90%	110%	90%	110%	F, K, L	
Startup (M € /1,000 t HVO)	0	0	0	0	0						

Notes:

- A. The plant size is assumed based on the plants sizes of existing HVO plants. Jet production is 80% of HVO diesel production with the other 20% representing increased co-products.
- A1. This value is the hourly rating and has been calculated as if the unit produces at capacity and was in operations 8,000 h/year.
- B. The plant size uncertainty represents the current range in the market.
- C. Performance is typical based similar performance to HVO diesel but with less primary product and more co-products.
- D. Hydrogen consumption is also a function of the feedstock to a small degree.
- E. The total capital cost include total installed cost (total direct costs) and all indirect costs such as engineering, construction, contractor's fee, contingency and working capital.
- F. O&M costs, costs for main raw materials are not included.
- G. There is limited potential for process improvements.
- H. Total output excludes the heat loss.
- I. Best plants operate at greater than 95% of capacity.
- J. Range of capital cost is +/- 25% of mean.
- K. Operating cost uncertainty is +/- 10% of mean.
- L. M €/k tonne is million euro per 1,000 tonnes.

References

- [1] AltAir. 2017. The Department of Energy: Wet and Gaseous Feedstocks: Barriers and Opportunities. https://energy.gov/sites/prod/files/2017/07/f35/BETO_2017WTE-Workshop_BryanSherbacow-AltAir.pdf
- [2] Antonissen, K. 2016. Greenhouse gas performance of renewable jet fuel: a comparison of conversion pathways. <https://dspace.library.uu.nl/bitstream/handle/1874/347665/MSc%20Thesis%20K.Y%20Antonissen%2c%20May%202016%20%281%29.pdf?sequence=2&isAllowed=y>
- [3] de Jong, S., Antonissen, K., Hoefnagels, R., Lonza, L., Wang, M., Faaij, A., and Junginger, M. 2017. Life-cycle analysis of greenhouse gas emissions from renewable jet fuel production. *Biotechnology for Biofuels* 2017:10:64. <https://doi.org/10.1186/s13068-017-0739-7>
- [4] Tao, L., Milbrandt, A., Zhang, Y., and Wang, W. 2017. Techno-economic and resource analysis of hydroprocessed renewable jet fuel. *Biotechnology for Biofuels*. 10:261. <https://doi.org/10.1186/s13068-017-0945-3>
- [5] Starck, L., Pidol, L., Jeuland, N., Chapus, T., Bogers, P., Bauldreay, J. 2016. Production of Hydroprocessed Esters and Fatty Acids (HEFA) - Optimization of Process Yield. *Oil Gas Sci. Technol. - Rev. IFP Energies nouvelles*. Volume 71, Number 1, January-February 2016. <https://doi.org/10.2516/ogst/2014007>
- [6] Stratton et al. 2010. Life Cycle Greenhouse Gas Emissions from Alternative Jet Fuels. <http://web.mit.edu/aeroastro/partner/reports/proj28/partner-proj28-2010-001.pdf>
- [7] de Jong, S., Hoefnagels, R., Faaij, A., Slade, R., Mawhood, R. and Junginger, M. 2015. The feasibility of short-term production strategies for renewable jet fuels – a comprehensive techno-economic comparison. *Biotechnology for Biofuels*, 9: 778–800. <https://www.doi.org/10.1002/bbb.1613>

93 1st Generation Ethanol

Contact Information:

Danish Energy Agency: Jacob Hjerrild Zeuthen, jhz@ens.dk and Filip Gamborg, fgb@ens.dk

Author: Don O'Connor – (S&T)² Consultants Inc.

Publication date

August 2018

Amendments after publication date

Date	Ref.	Description
12 2018		Datasheet revised

Qualitative Description

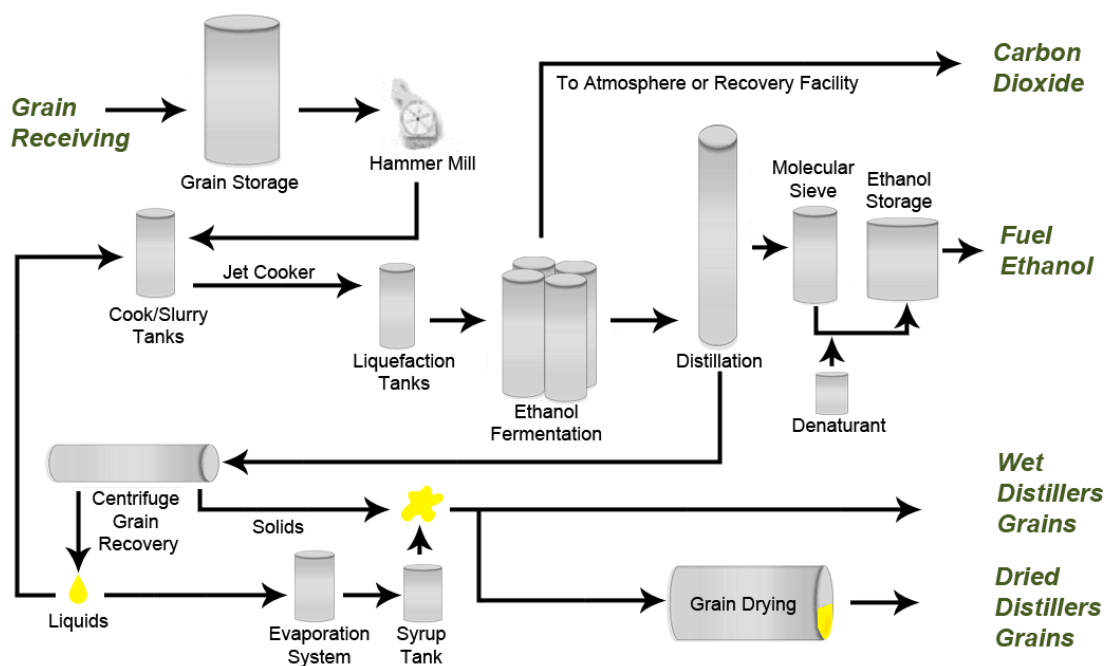

Figure 1 1st Generation Ethanol Production Process

Brief Technology Description

Cereal crops, with corn and wheat being the most common, are milled to reduce the particle size. The milled grain is mixed with water and a liquefying enzyme and heated to 90 to 100 °C to liquefy the starch in the grain. The slurry is cooled to 30 to 35 °C, a saccharification enzyme to convert the starch to fermentable sugars and yeast is added to ferment the sugars to ethanol and carbon dioxide. After about 48 hours the “beer” is sent to distillation columns to separate the ethanol and some of the water from the remaining solids. The ethanol stream has the remaining water removed in a molecular sieve or an anhydrous distillation

column. The ethanol is suitable for fuel blending at this stage. The distillation bottom columns are centrifuge to separate some of the solids from the liquid. The solids can be sold or sent to a dryer. The liquid can have corn oil removed and is then concentrated through a vacuum evaporation system to produce a syrup which can also be sold or sent to the dryer. The distillers' grains are used as a high protein animal feed.

Input

The primary inputs into the system are the corn or wheat feedstock, water, power and thermal energy. There are secondary inputs of enzymes, yeast, and acids and bases for pH adjustment.

Output

The primary outputs are ethanol and distillers' grains. The distillers' grains can be sold wet or dry, and either combined (where the solids and syrup are combined) or separately (where the solids and syrup streams are sold as individual products). Corn plants can also separate a small volume of corn oil which can be used for animal feed or as a FAME feedstock. The corn oil can have a much higher value when sold separately instead of as part of the distillers' grains. The oil content of wheat is too low to make the extraction practical.

Energy Balance

The energy balance of a 1st generation corn ethanol plant is shown in the following figure. This figure is based on an ethanol yield of 415 litres per tonne of corn. The ethanol yield is a function of the starch content of the grain and the plant conversion efficiencies, the typical range is 405 to 430 l/tonne [1]. The ratio of the energy of ethanol to Distillers' Dried Grains DDG will vary with the starch content of the feedstock. Wheat generally has a slightly lower ethanol output but higher DDG output. The natural gas and power requirements are typical values for a corn ethanol plant that dries all of the distillers' grains. Wheat plants will use more energy than corn plants as more DDG is produced that must be dried and the evaporation systems are generally not as efficient as the viscosity of the syrup is higher for a given solids content.

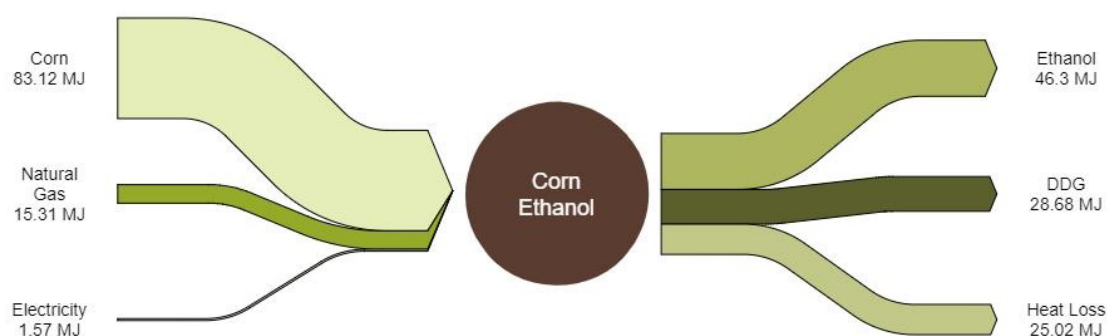

Figure 2 1st Generation Ethanol Energy Balance

Most of the unit operations in the process are undertaken at relatively low temperatures so the heat losses are low quality. Most of the heat is lost either through a cooling tower or in the exhaust stack of the distillers' grain dryer. A few plants have started to recover some of the latent heat of vapourization in the dryer exhaust and use the energy to reduce the purchased natural gas. The practice is not yet widespread.

Typical Capacities

In North America, the most recent new plants were built with 400 million litres of ethanol production capacity per year (320,000 tonnes ethanol per year, 280 MW). These plants generally had two production trains of 200 million litres per year each (160,000 tonnes ethanol per year).

Twenty-five years ago plants were typically 60 million litres per year. Over time capacities grew to take advantage of economies of scale.

Regulation Ability

Plants generally operate continuously with one or two shutdowns per year for maintenance. The process is biological and it is important to minimize the possibility of infections that can reduce yield and negatively impact the performance of equipment. This limits the potential for operations below about 80% of nameplate capacity. Lower production rates can only be achieved with more frequent start-up and shutdown cycles which increase the operating costs.

Space Requirements

Pannonia Ethanol in Hungary is a 430 million litre per year corn ethanol facility designed and built by the American company Fagen. It covers 22 ha on the banks of the Danube River. It was a greenfield plant.

The Vivergo Fuels 420 million litre per year wheat ethanol plant in the UK occupies 10 ha in an existing industrial complex. The site was chosen due to its existing infrastructure and utilities.

Space requirements will range from 0.024 to 0.052 ha/million litres (350 to 775 m²/M). Smaller plants may require more land per million litres than larger plants. The degree of integration with other infrastructure will also impact the land requirements.

Advantages/Disadvantages

1st generation ethanol is a well proven technology. It is the largest volume renewable fuel produced in the world today. Ethanol is a high octane fuel that can be used to increase the octane of the gasoline that it is blended with. This has the potential to reduce the GHG emissions of the petroleum refinery and increase the refinery energy efficiency, factors that are not often considered when the benefits of ethanol are discussed.

Ethanol does contain about 35% oxygen which limits the quantity that can be blended with gasoline. In Denmark, ethanol is blended at the 5% by volume level [2]. Europe, ethanol blended at the 10% by volume level is a relatively recent development. E10 is currently available in Belgium, Finland, France and Germany [3].

Environment

The lifecycle GHG emissions of 1st generation ethanol are about equally split between the feedstock production and fuel production [4]. Feedstock emissions are geographic specific and can vary significantly from country to country due to production practices.

Research and Development Perspective

First generation ethanol produced from corn and wheat is a category 4 technology; a commercial technology with large scale deployment. The price and performance of the technology today is well known and normally only incremental improvements over time would be expected. Therefore, the future price and performance may also be projected with a relatively high level of certainty.

Examples of Market Standard Technology

There are many suppliers of 1st generation ethanol technology. More than 50% of the US production capacity was designed by ICM Inc. They have also designed plants in Europe, Brazil, Argentina, and Africa.

ICM, Inc.

P.O. Box 397
310 N. First Street
Colwich, KS 67030-0397

The German company GEA is one of the largest suppliers of process technology for the food industry and a wide range of other industries, including fuel ethanol. They also have expertise with respect to wheat starch production.

GEA Group Aktiengesellschaft

Peter-Müller-Str. 12
40468 Düsseldorf
Germany

Predication of Performance and Cost

The corn ethanol industry has been studied from the perspective of the experience curve [5] [6]. There have been significant improvements in the performance of the technology over time and the improvements are in line with the expectations based on the production growth of the industry.

Uncertainty

Given the level of maturity of the industry there is a low level of uncertainty associated with information collected on the technology.

Additional Remarks

The world starch ethanol production is shown in the following figure [6]. The United States is the dominant producer and that is almost all produced from corn. Production in Canada and Europe is a mixture of wheat and corn plants.

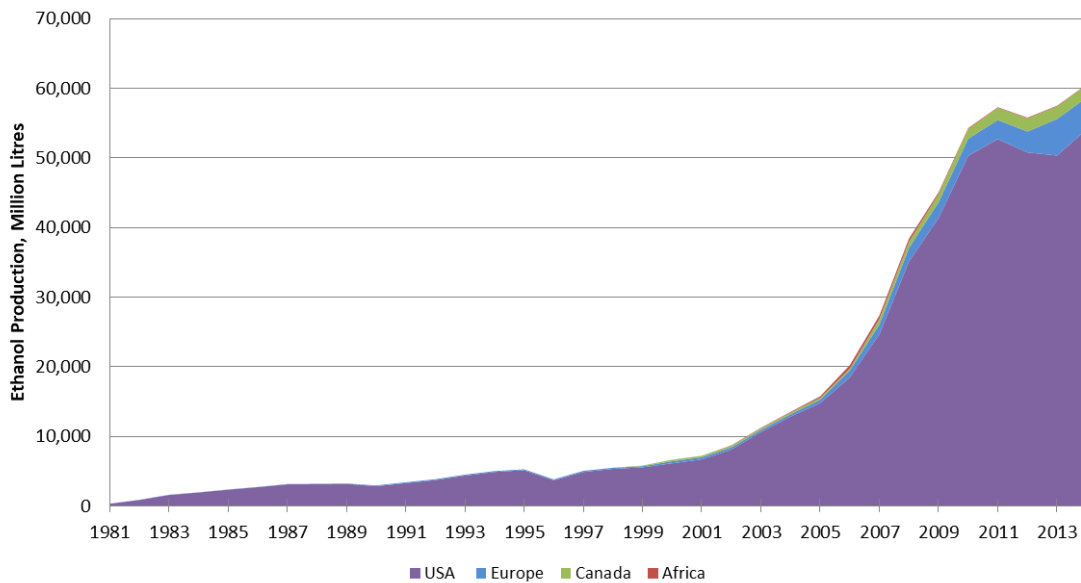

Figure 3 World Starch Ethanol Production

Production levels in the post 2010 period have not increased as rapidly as they did in the previous decade, as a result the rate of change in the technology has slowed down on a year over year basis since it takes longer to double the production in this decade than it did in the last decade.

Quantitative Description

There is a significant amount of quantitative information available for this technology since it is the largest renewable pathway in the world.

The process involves two chemical reactions. In the first, starch is hydrolyzed to glucose as shown below.

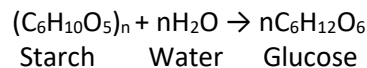

The glucose is then fermented with yeast to ethanol and carbon dioxide.

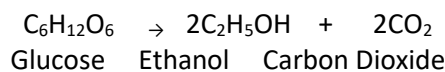

Typical Plant Size

Plant sizes can range up to 400 million litres per year (300 MW), although plants of this size often have two production trains. The dryers for the plants are often the limiting size of the production train, although the size of individual fermenters can also be a limiting factor. Most plants operate with four fermenters and a 48 to 60 hour fermentation cycle so fermenters can be quite large. The average plant size in Europe is smaller than this.

In their 2014 report on the industry, ePure [8] reported the production capacity of beverage and fuel ethanol plants and the number of plants by country. The fuel ethanol production capacity was reported to be 7 billion litres. The fuel ethanol industry apparently operated at 65% of capacity in 2014. That information along with the fuel ethanol production reported by Eurostat for 2014 is shown in the following table. Not all of these plants are currently operating.

Country	Production Capacity	No. Plants	Avg Size	2014 Fuel Production
	Million litres			Million Litres
France	2,300	19	121	975
Germany	1,400	12	117	897
United Kingdom	900	5	180	519
Poland	750	14	54	181
Spain	600	5	120	486
The Netherlands	575	2	288	0
Hungary	520	3	173	372
Belgium	500	3	167	325
Czech Republic	350	6	58	132
Italy	300	6	50	1
Sweden	275	6	46	175
Austria	250	2	125	262
Slovakia	240	1	240	134
Romania	200	3	67	15
Lithuania	100	2	50	13
Latvia	50	2	25	0
Bulgaria	50	2	25	27
Finland	50	4	13	24
Ireland	40	1	40	0
Denmark	30	1	30	0
Total	5783,7	99	96	4,538

Table 1 European Ethanol Plants

ePure reported that 31% of the feedstock in 2016 was corn, 32% was wheat and the remainder was sugar based and other cereals [9]. Ethanol production from corn in 2016 was 1.61 billion litres and from wheat was 1.66 billion litres.

Input and Output

The primary input is the grain feedstock and the electric power and thermal energy. The primary output is the ethanol, the DDG for animal feed, and some plants capture the CO₂ from the fermentation vessels for use in the industrial gas market. The inputs and outputs are shown in the following table.

Parameters	Input	Output
Feedstock	2.4 kg	
Power	0.20 kWh	

Natural gas	7 MJ	
Ethanol		1 litre
DDG		0.72 kg
CO ₂ (if captured)		0.75 kg
Corn Oil		0.03 kg

Table 2 Corn Ethanol Inputs and Outputs

The inputs and outputs for a wheat plant are slightly different since wheat usually has a lower starch content than corn. Feedstock consumed may be 2.6 kg/litre of ethanol and the DDG production may be 0.94 kg/litre. The energy consumption may be 9 to 10 MJ of natural gas per litre of ethanol. There can be variations in the feedstock starch contents from year to year and since wheat is a winter crop and corn is planted in the spring for a fall harvest, the ratio of the starch contents of corn and wheat can vary from year to year.

Future improvements can be expected in ethanol yield and energy use. In the US the ethanol yield has been increasing at about 0.2% per year. This is expected to continue. Natural gas energy use has been declining by 1.8% per year. This rate is expected to start to decline as the time to double production increases. It has been assumed that gas consumption declines by 20% over the next 30 years. Electric power consumption has shown little improvement in the past decade, which is not that surprising as the power consumption tends to be more a function of the original design rather than operating practices. No change in power production is forecast.

Forced and Planned Outage

Ethanol plants are generally designed to operate 350 days per year with 15 days for maintenance. Some plants take a maintenance break once per year and others will take two shorter breaks per year.

Since the process is a generally a combination of batch fermentation with intermediate storage tanks at the front and back ends of the plant, individual components can often be taken offline for cleaning or maintenance without impacting production rates. The industry generally has very high production utilization if the markets for the products are available. The European industry generally operates at lower rates of capacity utilization because of the smaller and less mature market than in North America.

Technical Lifetime

Plant lifetimes should exceed 25 years, as the US and EU starch ethanol industries have demonstrated.

Construction Time

Plants can generally be constructed in 18 to 24 months. There are no very high pressures or temperatures involved in the process which reduces the required lead time for process components.

Financial Data

There is more financial data available for the North America industry than there is for the European industry. Other than feedstock costs and selling prices the other categories of financial costs should be relatively similar for the two industries.

As with the FAME industry, Iowa State University maintains a financial model and monthly operating data for a 380 million litre corn ethanol plant located in Iowa [10].

Investment Costs

There have been relatively few 1st generation ethanol plants built since 2010. So the capital cost data is not as current as it used to be.

The Iowa State model has capital costs of \$181 million dollars excluding working capital. There are two corn ethanol plants that are under construction in the United States [11] [12]. One will produce 300 million litres and has a reported cost of \$150 million [12]. This included \$10 million in working capital. The other has a capacity of 450 million litres and has a cost of \$190 million [12].

	Iowa State	Ringneck Energy	Elite Octane
Capacity, million lpy	380	300	450
Capital cost, \$ Million	181	140	190
\$/annual litre	0.48	0.47	0.42

Table 3 Capital Costs

The three cost estimates are quite close. Converting this data to a European value using the methodology provided in the Introduction, the capital cost for this large plant is estimated as follows;

$$\$0.50/\text{litre} \cdot 0.85 \text{ €}/\$ \cdot 1.21 \text{ Europe factor} = 0.51 \text{ €}/\text{litre}$$

Given the slow pace of new plant construction it is expected that the future capital costs are a function of the plant scale and a 0.8 scaling factor and not of technology improvements.

Operating and Maintenance Costs

The operating and maintenance costs in the Iowa State model are used as the basis for the data table. The 2016 data has been used and the power and natural gas costs have been adjusted to the Danish values reported in section 1.4. The capital cost has been adjusted to 206 million Euro to match the value above. The results for 2016 are shown in the following table.

Parameter	Costs (Euro/litre)
Natural gas	0.043
Power	0.012
Other Variable	0.049
Fixed Costs	0.048
Total Costs ex feedstock	152

Table 4 Production Costs 1st Generation Ethanol

Fixed operating costs are not expected to change over time but the variable costs decrease as the energy use improves.

Start-up Costs

Start-up costs are included in the previous table.

Technology Specific Data

The properties of ethanol are shown in the following table. The ethanol molecule contains about 35% oxygen which reduces the volumetric energy density of the fuel.

Property	Value
Density, kg/m ³	790
LHV, MJ/kg	26.9
LHV, MJ/litre	21.3
Oxygen content	35%
Blending Octane number	~115
Flash point, C	13

Table 5 Ethanol Properties

Data sheet

The quantitative data for the 1st generation ethanol process are summarized in the following table.

Technology	1st Generation Ethanol										Note	Ref
	2015	2020	2030	2040	2050	Uncertainty (2020)		Uncertainty (2050)				
						Lower	Upper	Lower	Upper			
Energy/technical data												
Ethanol/year, 1,000 tonnes/year	320	320	400	450	500	50%	120%	60%	100%	A, B	11	
Ethanol/year, MW	280	280	350	400	440	50%	120%	60%	100%	A, B		
Inputs												
Feedstock Consumption, MWh/MWh Total Input	0.83	0.83	0.84	0.85	0.85	98%	105%	98%	102%	C		
Electricity Consumption, MWh/MWh Total Input	0.02	0.02	0.02	0.02	0.02	75%	125%	75%	125%	D		
Natural Gas Consumption, MWh/MWh Total Input	0.15	0.15	0.14	0.13	0.13	75%	125%	75%	125%	D		
Outputs												
Ethanol Output, MWh/MWh Total Inputs	0.46	46	0.47	0.47	0.47	0.95	1.02	0.95	1.02	E, F		
DDG Output, MWh/MWh Total Input	0.29	0.27	0.28	0.25	0.25	98%	105%	98%	102%	E, F		
Operational parameters												
Forced outage (%)	0	0	0	0	0							
Planned outage (weeks per year)	2	2	2	2	2							
Technical lifetime (years)	25	25	25	25	25							
Construction time (years)	2	2	2	2	2							
Financial data												
Specific investment (M€ /MW Ethanol)	0.74	0.72	0.69	0.66	0.66	95%	125%	95%	125%	I, J	10	
- equipment (%)	75	75	75	75	75							
-installation (%)	25	25	25	25	25							
Fixed O&M (M€ /MW/year)	0.061	0.061	0.061	0.061	0.061	95%	125%	95%	125%	J	8	
Variable O&M (€ /MWh)	8.301	8.301	8.301	8.301	8.301	90%	110%	90%	110%	G, B, J	8	
Start-up (M€ /1,000 t Ethanol)	0	0	0	0	0					H		
Technology specific data												
Specific energy content (GJ/ton)	26.9	26.9	26.9	26.9	26.9							
Specific density (kg/l) or (ton/m3)	0.79	0.79	0.79	0.79	0.79							
Specific investment (M€ /1,000 t Ethanol)	0.65	0.63	0.61	0.59	0.58	95%	125%	95%	125%	I, J	10	
- equipment (%)	75	75	75	75	75							
-installation (%)	25	25	25	25	25							
Fixed O&M (M€ /1,000 t Ethanol)	0.061	0.061	0.061	0.061	0.061	0.95	125%	95%	125%	J	8	
Variable O&M (M€ /1,000 t Ethanol)	0.062	0.062	0.062	0.062	0.062	90%	110%	90%	110%	G, B, J	8	
Start-up (M€ /1,000 t Ethanol)	0	0	0	0	0					H		

Notes:

- A. The plant size is assumed based on the plants sizes of existing ethanol plants.
- A1. This value is the hourly rating and has been calculated as if the unit produces at capacity and was in operations 8,000 h/year.
- B. The plant size uncertainty represents the current range in the market.
- C. The feedstock starch content impacts the yield. Ethanol yields in the United States have been slowly increasing from a combination of improved conversion efficiency and higher starch content of the feedstock.
- D. The upper and lower values are representative of the range between individual plants.
- E. Output excludes the low quality waste heat.
- F. Change over time is a function of increased ethanol yield, which also results in lower DDG yield as the mass must be conserved.
- G. Variable costs are reduced from improved energy efficiency.
- H. Start-up costs are included on variable costs.
- I. Capital costs can be site specific and process technology supplier dependent. The costs provided for in the table are from a technology developer with a reputation for low capital costs.
- J. M €/k tonne is million euro per 1,000 tonnes

References

- [1] (S&T)² Consultants Inc. Database of actual plant performance.
- [2] Energy Statistics 2015. https://ens.dk/sites/ens.dk/files/Statistik/energy_statistics_2015.pdf
- [3] ePure. 2017. Fuel Blends. <http://epure.org/about-ethanol/fuel-market/fuel-blends/>
- [4] Biograce Version 4d without the extra 30% processing energy factor.
- [5] Hettinga, W., Junginger, H., Dekker S., Hoogwijk, M., McAloon, A., Hicks, K. 2009. Understanding the reductions in US corn ethanol production costs: An experience curve approach. Energy Policy 37(2009)190–203. <http://naldc.nal.usda.gov/download/22550/PDF>
- [6] IEA Bioenergy Task 39. 2009. Potential for Improving Carbon/Energy Balance of Bioethanol. http://task39.sites.olt.ubc.ca/files/2013/05/IEA_Bioenergy_Task-39_Improving_carbon_and_energy_balance.pdf
- [7] US Energy Information Administration. 2015. International Energy Statistics. Biofuels Production. <http://www.eia.gov/cfapps/ipdbproject/IEDIndex3.cfm?tid=79&pid=79&aid=1>
- [8] ePure. 2014. State of the Industry Report 2014. <http://epure.org/media/1137/state-of-the-industry-report-2014.pdf>
- [9] ePure. 2017. 2016 Industry Statistics. <http://epure.org/media/1610/2016-industry-statistics.pdf>
- [10] Iowa State University. 2017. Ethanol Profitability. <http://www.extension.iastate.edu/agdm/energy/xls/d1-10ethanolprofitability.xlsx>
- [11] Capital Journal. Oct. 10, 2017. Ringneck Energy pouring cement, building foundations for ethanol plant near Onida. http://www.capjournal.com/news/ringneck-energy-pouring-cement-building-foundations-for-ethanol-plant-near/article_4ee23aac-aded-11e7-80fb-a7814e744ba7.html
- [12] Biofuel Journal. 2017. Third Quarter. Construction begins. Page 40-42.
- [13] Ringneck Energy prospectus. 2016. http://ringneckenergy.com/wp-content/uploads/2016/12/2015_PPM_w_Exhibits.pdf

94 Pyrolysis Oils

Contact Information:

Danish Energy Agency: Jacob Hjerrild Zeuthen, jhz@ens.dk and Filip Gamborg, fgb@ens.dk

Author: Don O'Connor – (S&T)² Consultants Inc.

Publication date

August 2018

Amendments after publication date

Date	Ref.	Description
12 2018		Datasheet revised

Qualitative Description

Pyrolysis is the thermal decomposition of biomass occurring in the absence of oxygen. It is the fundamental chemical reaction that is the precursor of both the combustion and gasification processes. The products of biomass pyrolysis include biochar, bio-oil and gases including methane, hydrogen, carbon monoxide, and carbon dioxide.

A wide range of biomass feedstocks can be used in pyrolysis processes, however the pyrolysis process is very dependent on the moisture content of the feedstock, which should be around 10%.

Pyrolysis processes can be categorized as slow pyrolysis or fast pyrolysis. Fast pyrolysis is currently the most widely used pyrolysis system. Slow pyrolysis takes several hours to complete and results in biochar as the main product. On the other hand, fast pyrolysis yields 60% bio-oil and takes seconds for complete pyrolysis.

Pyrolysis can be performed at relatively small scale and at remote locations which enhance energy density of the biomass resource and reduce transport and handling costs. Pyrolysis offers a flexible and attractive way of converting solid biomass into an easily stored and transported liquid, which can be successfully used for the production of heat, power and chemicals.

This section considers fast pyrolysis systems.

Brief Technology Description

Fast pyrolysis is a high temperature process in which biomass is rapidly heated in the absence of oxygen. As a result it decomposes to generate mostly vapours and aerosols and some charcoal. Liquid production requires very low vapour residence time to minimise secondary reactions of typically 1 s, although acceptable yields can be obtained at residence times of up to 5 s if the vapour temperature is kept below 400 °C. After cooling and condensation, a dark brown mobile liquid is formed which has a heating value about half that of conventional fuel oil. The basic process flow is shown in the following figure.

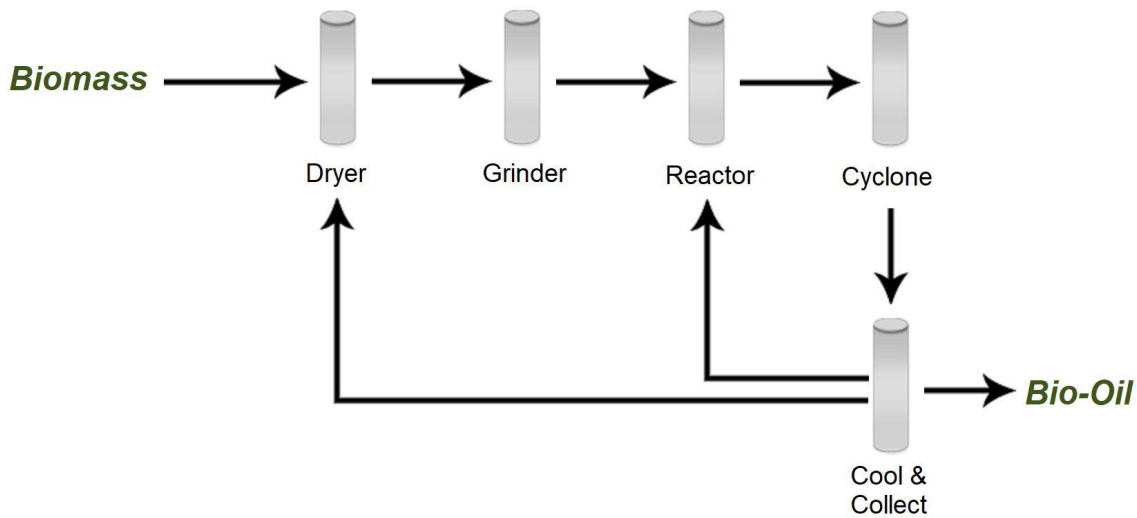

Figure 1 Fast Pyrolysis Process Flow

Input

The process inputs are dry biomass, some electricity is required to operate the process. The produced gas can be used to dry the feedstock or it could be used for power generation when dry feedstock is available.

Output

The primary output from the system is the bio-oil, and potentially some char and produced gas depending on the design of the system, operating conditions and the feedstocks used.

Energy Balance

The energy balance of the process is shown in the following figure [1]. This energy balance is based on laboratory scale operations and could change with feedstock and operating conditions. This system combusts the biochar that is produced to drive the reactions, producing just bio oil, steam and possibly electric power.

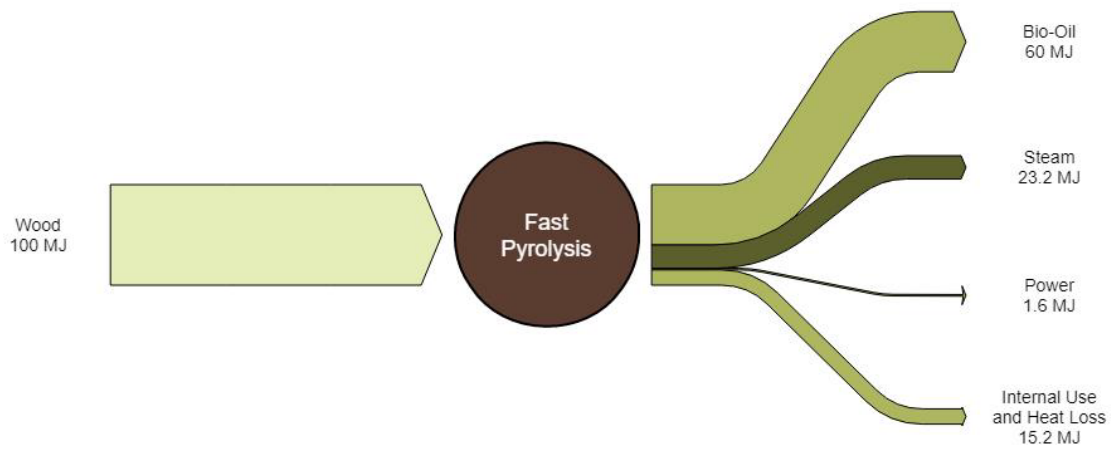

Figure 2 Fast Pyrolysis Oil Energy Balance

Typical Capacities

BTG Bioliquids operates a 5 T per hour (tph) fast pyrolysis system in Hengelo, The Netherlands [2]. The plant produces approximately 20 million litres per year of bio oil. In Canada, Ensyn is completing construction of a 8.3 tph plant in Port Cartier, Quebec [3]. Ensyn has several 16.7 tph projects in development around the world. The largest plants will produce approximately 75 million litres per year of bio oil.

Regulation Ability

The operating temperature of the reaction zone of the systems drives product yields and ratios of liquids to gas and char [4]. This is shown in the following figure.

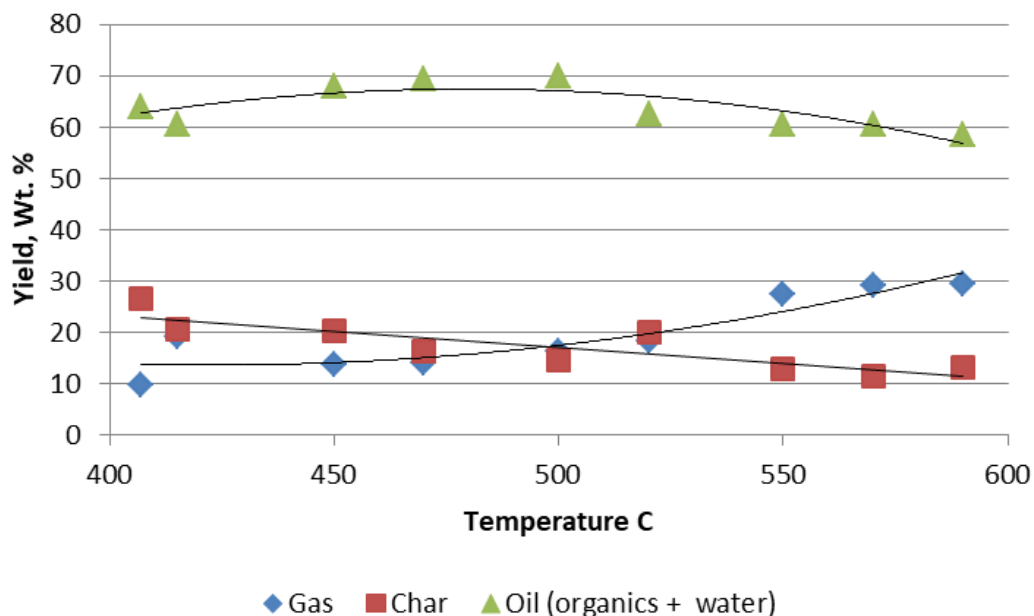

Figure 3 Typical product Yields vs. Temperature

The regulation capacity of the systems is therefore limited. Operating outside of the optimal temperature zone will result in a loss of oil yield.

Space Requirements

Ensyn operates a 10 million litre per year facility in Renfrew Ontario. The plant is located on 6.4 ha of land. This is 0.64 ha/million litres. The BTG plant in Hengelo, which has a larger capacity occupies only 0.10 ha but has limited storage capacity for feedstock and finished products and is located in a less harsh climate.

Advantages/Disadvantages

The primary attractiveness of the technology is that biomass can be converted into a liquid fuel. The pyrolysis oil contains 30 to 50% oxygen and has a high water content and total acid number. It is not miscible in liquid hydrocarbons. It is used as a boiler fuel in North America and in Europe.

The energy density of the oil is higher than the biomass used to produce it and it can be more easily transported.

The characteristics of the oil can be improved by removing the oxygen either through hydrotreating (hydrodeoxygenation and/or decarboxylation) or feeding the product into a fluid catalytic cracker or a hydrocracker at a petroleum refinery (hydrotreating + hydrocracking).

Hydrodeoxygenation requires high hydrogen pressure and consumes hydrogen but results in a high yield. Single stage hydrotreating can be difficult to achieve due to excess coking. Two stage hydrotreating and the use a co-solvent are options. Hydrogen consumption can be on the order of 15% by weight of the hydrotreated product.

Decarboxylation can be obtained at lower applied hydrogen pressure and does not consume the hydrogen but results in a lower liquid yield.

Environment

The GHG emission performance of the pyrolysis oil should be very good as most of the energy to drive the process comes from the biomass feedstock. The GHG emissions of the hydrotreated pyrolysis oil will be less attractive due to the hydrogen requirement but it will depend on the how the hydrogen is produced.

Research and Development Perspective

Fast pyrolysis of biomass to produce a bio-oil is a category 2 technology, a technology in the pioneer stage with limited applications at scale. There is significant uncertainty with respect to the performance and costs of the technology.

There is potential to improve yields and reduce costs as more experience with the technology is gained from the existing semi-commercial demonstration facilities and then the technology is scaled to commercial plants.

Examples of Market Standard Technology

Since this is a Category 2 technology there are no market standard technologies. One of the leading development companies with this technology is the Dutch company BTG Bioliquids. They have a commercial demonstration plant operating in The Netherlands.

BTG Bioliquids

Josink Esweg 34

7545 PN Enschede

The Netherlands

<https://www.btg-btl.com/en>

The other major technology supplier is the Canadian company, Ensyn Technologies Inc. They have formed a joint venture with Honeywell UOP and offer the technology through a company called Envergent Technologies. Envergent provides licensing, engineering services and equipment supply related to RTP biomass conversion equipment, with performance guarantees, to RFO production projects worldwide. Under this joint venture, engineering of the RTP equipment is subcontracted to Honeywell UOP.

Honeywell UOP has also partnered with Ensyn in the commercial development of Refinery Co-processing opportunities. Honeywell UOP is assisting Ensyn in interfacing with refiners and offers refineries delivery systems which allow the refiner to integrate Ensyn's biocrude into their refineries.

Ensyn Technologies Inc.

Corporate Offices and Engineering

2 Gurdwara Road, Suite 210

Ottawa, Ontario K2E 1A2

Canada

<http://www.ensyn.com/>

Predication of Performance and Cost

Costs for the first of kind facilities are available and some information on the performance of the BTG facility is available.

Uncertainty

There is some uncertainty with respect to performance and economics, particularly related to scaling issues due to the stage of the development of the technology.

Additional Remarks

There is significant interest in this pathway from petroleum refiners. The potential of pyrolysis oils to be co-processed in a petroleum refinery to produce gasoline and diesel blending components without oxygen is attractive to refiners who are mandated to lower the carbon intensity of the products used for transportation applications.

Quantitative Description

Biomass is a mixture of hemicellulose, cellulose, lignin and minor amounts of other organics which each pyrolyse or degrade at different rates and by different mechanisms and pathways. Lignin decomposes over a wider temperature range compared to cellulose and hemicellulose which rapidly degrade over narrower temperature ranges. The rate and extent of decomposition of each of these components depends on the process parameters of reactor (pyrolysis) temperature, biomass heating rate and pressure. The degree of secondary reaction (and hence the product yields) of the gas/vapour products depends on the time-temperature history to which they are subjected before collection, which includes the influence of the reactor configuration.

The essential features of a fast pyrolysis process are:

- Very high heat transfer rates which usually requires finely ground biomass.
- Reaction temperatures of about 500 C and short vapour residence times of less than 2 seconds
- Rapid cooling of the vapours to produce the bio-oil product.

Typical Plant Size

Ensyn plant sizes have been increasing as additional projects are developed. Their existing commercial plant in Ontario produces 10 million litres per year. The BTG plant has a capacity of about 20 million litres per year. The Ensyn Quebec project that is nearing completion will have a capacity of 40 million litres per year and projects in Brazil and the United States have capacities of 75 million litres per year. These different plant sizes are shown in the following table with different approximate equivalent metrics.

Volume Based, Million litres per year	Input Mass Based, tpy	Energy Output Based, GJ/day
10	20,000	650
20	40,000	1,300
40	80,000	2,600
75	150,000	5,200

Table 1 Typical Plant Size

Input and Output

The input and output for a 150,000 tpy plant is shown in the following table.

	Input	Output
Wood, tonnes/year	150,000	
Bio-oil, litres/year		75,000,000

Table 2 Typical Input and Output

Forced and Planned Outage

The plants operate continuously. BTG have stated that they have almost reached the design value of 1900 hours/quarter of operating time [5].

Technical Lifetime

Plants of this type would normally be designed for at least a 20 year lifetime.

Construction Time

The Ensyn Quebec project started construction in June 2016 and is in the commission phase in the first quarter of 2018. Construction times of 18 to 24 months can be expected.

Financial Data

In addition to the public information on the capital costs for the recent BTG and Ensyn facilities there are several sources of detailed information [6] [7] [8] on capital costs and operating costs are in the public domain. These have been generated by independent third parties and not by the leading process developers.

Investment Costs

The BTG Hengelo facility had a project cost of €19 million [9]. The capital cost is essentially €1.0 per annual litre of production. The Ensyn Quebec Project had an announced capital cost of \$103 million Canadian (€70 million) [10]. This is a cost of €1.75 per annual litre of production.

In 2010 Wright et al [6] developed the capital and operating costs for a fast pyrolysis system with hydrotreating. The information was detailed enough to be able to remove the hydrotreating costs. The plant processed 2000 tpd of biomass to 1 million litres of bio-oil per day. The nth plant capital cost excluding the hydrotreating was \$250 million, or \$0.25/litre. The nth plant capital cost was 31.5% of the pioneer plant cost.

Hu et al [7] presented the capital costs without upgrading of about \$215 million for the 2000 tpd facility and slightly higher product yields of 1.1 million litres/day. A number of the participants on this paper also contributed to the earlier work by Wright et al. Shemfe [8] looked at a 72 tpd plant with hydrotreating. The

capital cost was estimated to be £6.6 million (~€5.5 million) for the pyrolysis portion and £10 million for the hydrotreating portion. The plant produced 7.9 million litres of gasoline equivalent after hydrotreating.

We have assumed that the first of kind plants have capital costs of €1.0 per annual litre of production and that the nth plants will be able to reduce that to €0.30 per annual litre of production.

Operating and Maintenance Costs

Wright reported fixed costs of \$11.5 million per year and variable operating costs ex feedstock of \$3.6 million per year. At 350 million litres of pyrolysis oil per year those costs amount to \$0.03 and \$0.01 per litre for Fixed and Variable O&M costs respectively.

Start-up Costs

The start-up costs are included in the operating cost estimates.

Technology Specific Data

The properties of fast pyrolysis oil are shown in the following table [11] and compared to typical values for heavy fuel oil [12]. The bio-oil has some oxygen which reduces the energy content and increases the density.

Parameter	Fast Pyrolysis Oil	Heavy Fuel Oil
Energy Content, MJ/kg (LHV)	16	39
Water Content, wt. %	25	0.1
Density, kg/m ³	1.20	0.98
Oxygen Content, wt. %	47	0
Pour Point, C	-36	15
Flash Point, C	50	100
Kinematic viscosity at 40 °C, mm ² /s	13	
Kinematic viscosity at 50 °C, mm ² /s		200-600

Table 3 Fast Pyrolysis Bio-Oil Properties

Data sheet

The information on pyrolysis oil production is summarized in the following table.

Technology	Fast Pyrolysis Bio Oil										Note	Ref
	2015	2020	2030	2040	2050	Uncertainty (2020)		Uncertainty (2050)				
						Lower	Upper	Lower	Upper			
Energy/technical data												
Typical total plant size 1,000 t Bio Oil/year	20	80	200	500	1000	50%	125%	75%	125%	A, B	1, 6	
Typical total plant size. MW	10	40	105	265	520	50%	125%	75%	125%	A, A1, B	1, 6	
Inputs												
Feedstock Consumption, MWh/MWh Total Input	1	1	1	1	1	90%	150%	90%	125%	E	4	
Outputs												
Bio Oil Output, MWh/MWh Total Input	0.6	0.6	0.62	0.64	0.65	90%	110%	90%	110%	E	4	
Steam, Output, MWh/MWh Total Input	0.232	0.232	0.232	0.232	0.232	90%	110%	90%	110%	E	4	
Power, Output, MWh/MWh Total Input	0.016	0.016	0.016	0.016	0.016	90%	110%	90%	110%	E	4	
Operational data												
Forced outage (%)	n.a.	4	0	0	0							
Planned outage (weeks per year)	4	4	4	4	4					C	8	
Technical lifetime (years)	25	25	25	25	25							
Construction time (years)	2	2	2	2	2							
Financial data												
Specific investment (M€ /MW Bio Oil)	2.4	1.9	1.1	0.8	0.7	75%	125%	75%	125%	D, G	6, 8	
- equipment (%)	75	75	75	75	75							
-installation (%)	25	25	25	25	25							
Fixed O&M (M€ /MW/year Bio Oil)	0.072	0.072	0.069	0.068	0.069	75%	125%	75%	125%	F, G	6	
Variable O&M (€ /MWh Bio Oil)	2.70	2.70	2.70	2.70	2.70	75%	125%	75%	125%	F, G	6	
Start up (M€ /1,000 t Bio Oil)	n.a.	0	0	0	0							
Technology specific data												
Specific energy content (GJ/ton) bio-oil)	16	16	16	16	16							
Specific density (kg/l) or (ton/m3)	1.2	1.2	1.2	1.2	1.2							
Specific investment (M€ /1,000 t Bio Oil)	1.2	0.96	0.6	0.45	0.36	75%	125%	75%	125%	D, G	6, 8	
- equipment (%)	75	75	75	75	75							
-installation (%)	25	25	25	25	25							
Fixed O&M (M€ /1,000 t Bio Oil)	0.036	0.036	0.036	0.036	0.036	75%	125%	75%	125%	F, G	6	
Variable O&M (M€ /1,000 t Bio Oil)	0.012	0.012	0.012	0.012	0.012	75%	125%	75%	125%	F, G	6	
Start up (M€ /1,000 t Bio Oil)	n.a.	0	0	0	0							

Notes:

- A. The plant size range is likely limited by the feedstock availability.
- A1. This value is the hourly rating and has been calculated as if the unit produces at capacity and was in operations 8,000 h/year.
- B. The plant size range is typical of the range found in the literature. It is highly uncertain given that the commercial demonstration plants in operation are much smaller.
- C. This is twice the time normally found in process operations.
- D. Capital costs for nth plant are used for 2050 and earlier costs are estimates.
- E. These are based on the commercial demonstration plant results.
- F. Nth plant estimates.
- G. M €/k tonne is million euro per 1,000 tonnes

References

- [1] Muggen, G. 2015. Looking back at the first half year of commercial scale pyrolysis oil production at Empyro. tcbiomass Chicago November 4th 2015. http://www.gastechnology.org/tcbiomass/tcb2015/Muggen_Gerhard-Presentation-tcbiomass2015.pdf
- [2] BTG Bioliquids. Empyro project. <https://www.btg-btl.com/en/company/projects/empyro>
- [3] Mahajan. M. 2018. Biomass-A Massive opportunity in disguise. https://ec.europa.eu/energy/sites/ener/files/documents/32_dharmesh_mahajan-honeywell.pdf
- [4] Bridgwater, A., Meier, D. Radlein, D. 1999. An overview of fast pyrolysis of biomass. Organic Geochemistry, Volume 30, Issue 12, Pages 1479-1493, [https://doi.org/10.1016/S0146-6380\(99\)00120-5](https://doi.org/10.1016/S0146-6380(99)00120-5).
- [5] BTG. November 2017 Newsletter. <https://www.btg-btl.com/nieuwsbrieven/2017/november/en>
- [6] Mark M. Wright, Justinus A. Satrio, and Robert C. Brown 2010. Techno-Economic Analysis of Biomass Fast Pyrolysis to Transportation Fuels <https://www.nrel.gov/docs/fy11osti/46586.pdf>
- [7] Hu, W., Dang, Q., Rover, M., Brown, R., Wright, M. 2015. Comparative techno-economic analysis of advanced biofuels, biochemicals, and hydrocarbon chemicals via the fast pyrolysis platform. Biofuels, 7:1, 57-67. <http://dx.doi.org/10.1080/17597269.2015.1118780>
- [8] Shemfe, M., Sai Gu, S., Ranganathan, P. 2015. Techno-economic performance analysis of biofuel production and miniature electric power generation from biomass fast pyrolysis and bio-oil upgrading, Fuel, Volume 143, 2015, Pages 361-372, <https://doi.org/10.1016/j.fuel.2014.11.078>.
- [9] BE-Sustainable. 2014. Empyro BV breaks ground of its biomass to liquid pyrolysis plant. <http://www.besustainablemagazine.com/cms2/empyro-bv-breaks-ground-of-its-biomass-to-liquid-pyrolysis-plant/>
- [10] Ensyn. 2016. Scale-up & Optimization BETO Workshop. https://www.energy.gov/sites/prod/files/2016/10/f33/Graham_0.pdf
- [11] BTG. Pyrolysis oil properties. <https://www.btg-btl.com/en/applications/oilproperties>
- [12] Environment Canada. 1999. Bunker C Fuel Oil. www.etc-cte.ec.gc.ca/databases/oilproperties/pdf/web_bunker_c_fuel_oil.pdf

95 Cellulosic Ethanol

Contact Information:

Danish Energy Agency: Jacob Hjerrild Zeuthen, jhz@ens.dk and Filip Gamborg, fgb@ens.dk

Author: Don O'Connor – (S&T)² Consultants Inc.

Publication date

August 2018

Amendments after publication date

Date	Ref.	Description
12 2018		Datasheet revised

Qualitative Description

Cellulose is an important structural component of the primary cell wall of green plants. It is an organic compound with the formula $(C_6H_{10}O_5)_n$, a polysaccharide consisting of a linear chain of several hundred to many thousands of $\beta(1\rightarrow4)$ linked D-glucose units. The basic chemical formula is the same as for starch with the difference being that the “n” is much larger for cellulose.

If the cellulose can be broken down into the glucose molecules then those can be fermented into ethanol and the rest of the process is similar to the 1st generation starch ethanol process.

Brief Technology Description

The cellulosic feedstock, which could be straw, corn stover, bagasse, or wood residue is generally subjected to a pretreatment stage to separate the cellulosic portion of the material from the lignin and make the feedstock amenable to hydrolysis. The pretreatment stage may use acid and or steam to accomplish the goal.

The hydrolysis stage breaks down the cellulose molecules into smaller polysaccharides or completely into glucose units; this is a hydrolysis reaction. Hydrolysis can be carried out with cellulase enzymes or with acid. Most process developers are using enzymes.

Following the hydrolysis stage a yeast is added to convert the sugars into ethanol and carbon dioxide. The “beer” is then distilled to remove ethanol and water from the unfermented solids. A second distillation column to reach 95% ethanol and 5% water is followed by a molecular sieve to produce anhydrous ethanol by most process developers.

The unfermented solids have little value as animal feed and process developers generally convert the material to energy (thermal and electricity) to be used in the process with any excess being exported to the grid.

A typical process flow diagram is shown in the following figure.

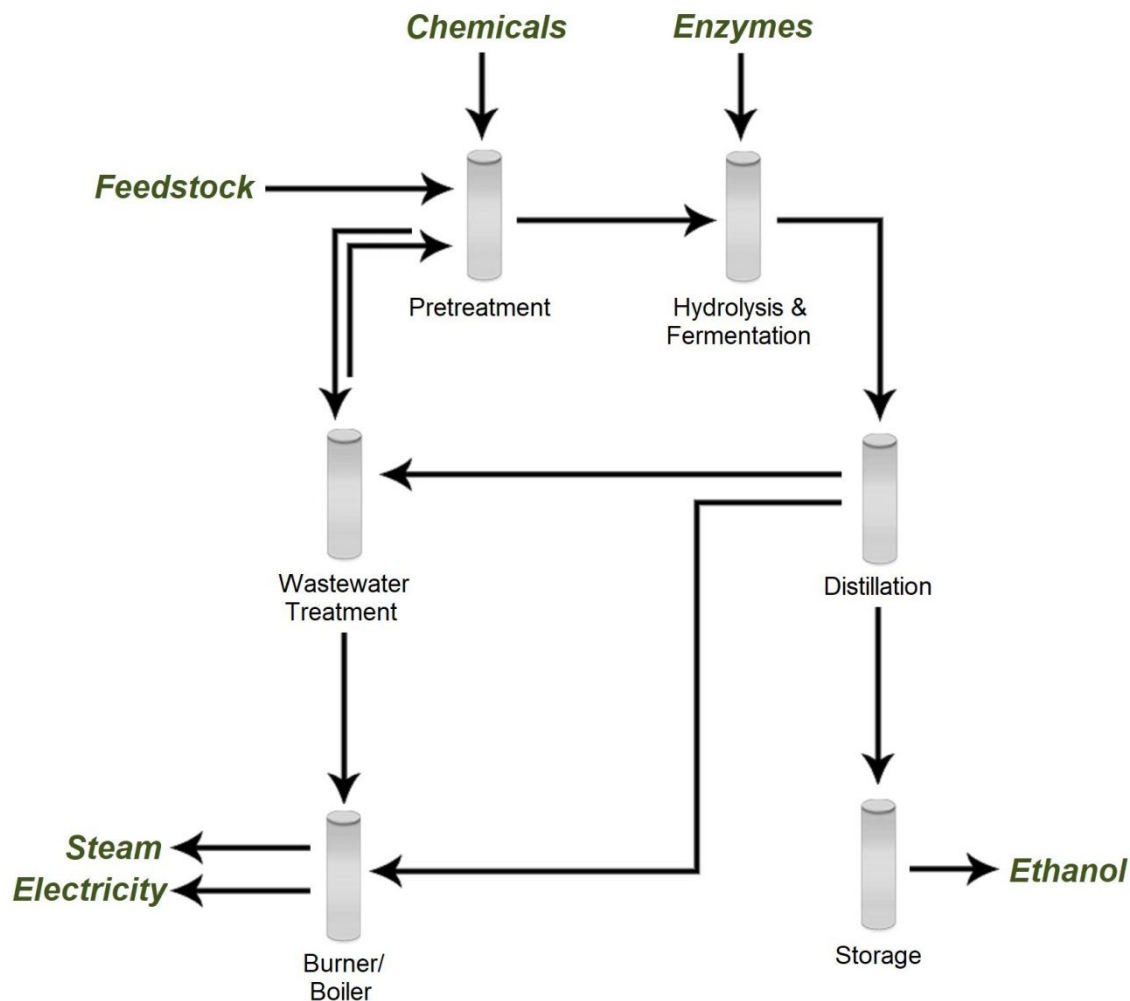

Figure 1 Cellulosic Ethanol Process

Input

The primary input is the cellulosic feedstock, along with water and the chemicals or enzymes used in the process. The quantity and type of feedstock vary between process developers.

Output

The output from the system is ethanol and in most cases some electricity. With most developers the lignin and unfermented solids are burned and/or anaerobically digested to produce energy for the process. Some integrated biorefinery designs would use vinasse (stillage) from the ethanol production for biogas production, which can be used directly for (on-site) CHP or upgraded to be sold or added to the local gas grid. Lignin and other combustibles would be used for CHP and any excess electricity and heat could be sold externally. Some developers try to sell the stillage (unfermented solids) as a fertilizer for field application. This will return the nitrogen, phosphorus and phosphates in the straw to the fields and replace the synthetic fertilizers that would be used to replace these nutrients.

Energy Balance

There are a number of technology developers working on cellulosic ethanol processes. There are different approaches to the basic system that are being employed. As this is a new technology, developers do not release too much information to the public. The most detailed techno-economic information available is from the US National Renewable Energy Laboratory [1]. This information is now dated and likely doesn't represent the current state of the art but it is still the most complete analysis available. A Sankey diagram based on published data from the US National Renewable Energy Laboratory is shown in the following figure.

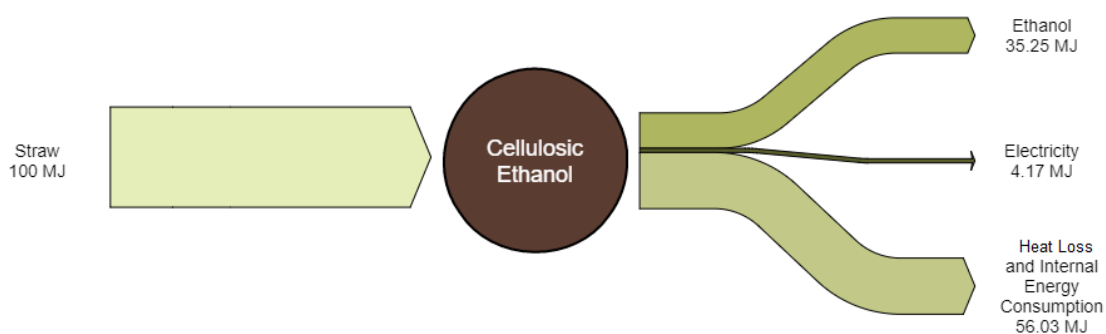

Figure 2 Cellulosic Ethanol Energy Balance

This process also consumes a significant quantity of chemicals to assist with the process and waste treatment. The Sankey diagram when these chemicals are included is shown in the following figure. The chemical energy is the energy required to produce and transport the chemicals.

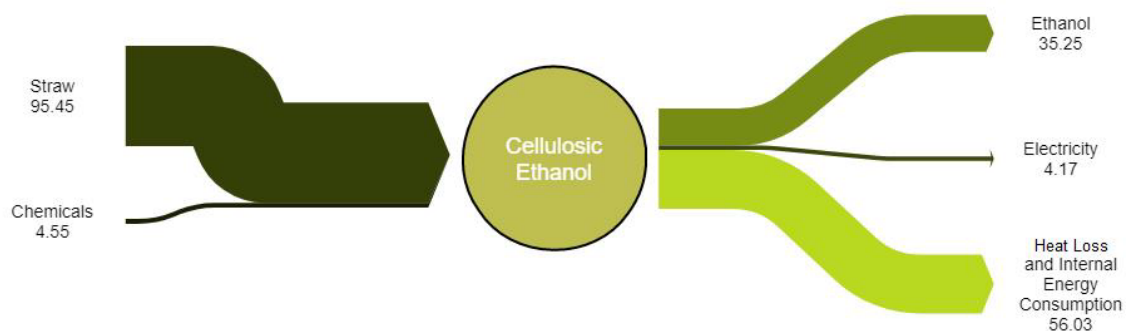

Figure 3 Cellulosic Ethanol Energy Balance with Chemicals

The process generates its own energy for use in the process. This is reflected in the high internal energy consumption shown in the figure. The process also consumes significantly more energy than the 1st generation ethanol processes.

For comparison the Sankey diagram for the Inbicon technology is shown in the following figure [2].

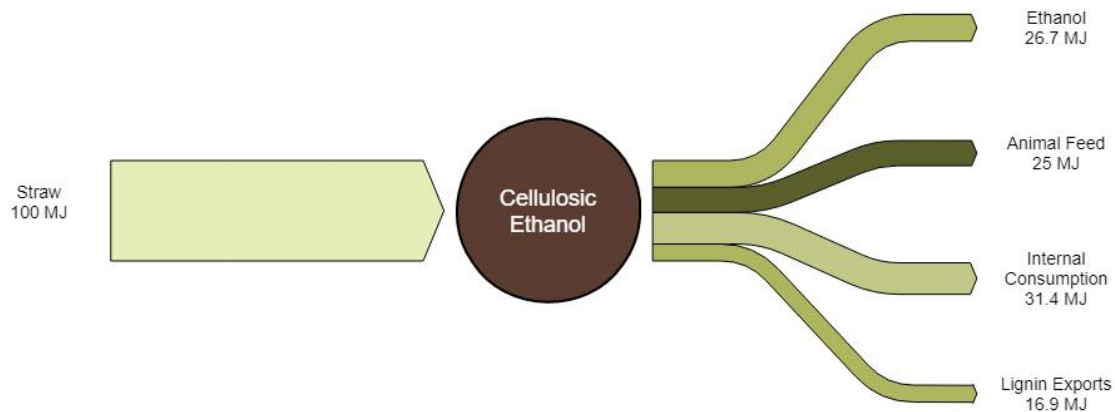

Figure 4 Inbicon Cellulosic Ethanol Energy Balance

This technology has much lower ethanol production but also produced animal feed and lignin for energy applications after some of the lignin was used to supply the heat and power for the facilities. The Inbicon plants were designed to be integrated with power plants, which also allows the diversion of the lignin and animal feeds streams to power generation depending on the location specific opportunities.

Typical Capacities

There have been about a half dozen commercial demonstration plants built in Europe, Brazil and the United States over the past five years. The plants have been sized in the 60 to 115 million litre per year range (45 to 80 MW), however few of the plants have been able to operate at capacity for significant periods of time but several plants are making progress towards operating at design capacity. The plants consume 50,000 to 100,000 tonnes of feedstock per year when operated at capacity.

Regulation Ability

Since most of the plants have not been able to operate continuously for extended periods of time it has been difficult to assess their regulation capabilities. In theory, the regulation capabilities should be similar to those of the 1st generation plants but the added complexity of the process and the fact that the process supplies the fuel for the process may limit the regulation capacity.

Space Requirements

The 50 million litre per year Beta Renewables Plant in Italy covers an area of 14 ha including some feedstock storage. The 110 million litre per year DuPont facility in Nevada Iowa has an area of 18.5 ha, excluding the storage area. The storage area appears to be twice the size of the plant. The 80 million litre per year POET DSM covers an area of 120 ha including feedstock storage.

The space requirements for the plant do vary significantly, some of which is due to the need to store a year or more of feedstock on the site. Space requirements of 0.5 ha/million litres (7000 m²/MW) would appear to be a reasonable value which allows room for feedstock storage.

Advantages/Disadvantages

The cellulosic ethanol process utilizes a feedstock that is largely underutilized in most agricultural regions of the world, thus there is no perceived competition for feed and food crops. The GHG emissions are similar to those of sugarcane ethanol, where crop residues provide the energy for the process.

The technology is complex and capital costs will be higher than for 1st generation ethanol plants. The technology complexity has also negatively impacted the time required to commercialize the process. The POET DSM plant has only recently announced that they have been able to solve the pre-treatment challenges and have been able to run the plant at 80% of capacity [3]. This is three years after the plant opened.

Other large scale first of kind plants have also had commercial and technical challenges, for example the DuPont plant is now for sale, the Beta Renewables plant in Italy has been idled and the Abengoa plant in Kansas was sold in a bankruptcy sale. The exact reasons for these decisions are not public and in some cases the decisions may have been due to other challenges that the companies may have faced or changes in business priorities. Operations at some of these plants may resume with new owners.

POET DSM [4] reported that in addition to resolving the technical challenges of pretreatment that they have decided to build an on-site enzyme production facility. Presumably this is a commercial decision; on-site production would not need to concentrate the enzyme to reduce transportation costs, saving capital and operating costs.

Van der Meij [5] recently presented a venture capitalist's view of the technology and stated that he could not see the business case for the technology citing feedstock logistics costs, scale, high pretreatment costs and margin uncertainty as issues. He also stated that there was still significant technology risk present. Nevertheless, new plants are being announced [9] [10].

Environment

In some regions of the world there is concern that removing too much straw from the field will have negative impacts on soil health. Reduced soil carbon and increased erosion potential are potential outcomes if the crop residue harvest is not undertaken in a sustainable manner.

Research and Development Perspective

Cellulosic ethanol produced from straw is a category 2 technology, a pioneer phase technology with limited applications to date. The technology has been proven to work through demonstration facilities or semi-commercial plants. However, due to the limited application, the price and performance is still attached with high uncertainty, since development and customization is still needed. The technology still has a significant development potential.

This technology has probably had more research undertaken on it than all of the other technologies in this report. As the technology has been scaled to near commercial scale many of the process developers have experienced significant challenges with materials handling through the front end of the process.

The challenges of operating the first of a kind cellulosic ethanol facility were acknowledged by Merritt [6]. He stated that three years after start-up the plant is operating at 80% of capacity, converting 95% of the fermentable sugars to ethanol at the design solids loading. The engineering focus is now on how to simplify the process and reduce capital costs, exactly the activities that create the learning curve. He also highlights advances in enzyme effectiveness in reducing future operating costs.

Examples of Market Standard Technology

The cellulosic ethanol technology has recently suffered some setbacks with respect to the commercialization of the technology.

One of the early movers on the commercialization of cellulosic ethanol technology was the Danish company Inbicon. However they have had difficulty in developing a commercial project without government guarantees.

The Italian company, Gruppo Mossi Ghisolfi, which developed the Beta Renewables plant in Crescentino Italy and supplied the technology for the GranBio plant in Brazil, has recently been granted protection from creditors [7].

DuPont has recently put their Nevada Iowa plant up for sale [8].

The one company that has recently moved ahead with new projects is Clariant. They have announced a license agreement with Enviral [9] to add a 50 million litre per year plant to an existing facility in Slovakia and a similar sized plant to be built in Romania [10].

Clariant Produkte Deutschland GmbH

Biotech & Renewables Center
Staffelseestrasse 6
D-81477 Munich, Germany

Predication of Performance and Cost

This technology is at the early stages of commercialization. There are some reported capital costs for the first commercial scale plants (pioneer plants) but there is no published, independently verified information on the actual performance of the plants.

It is expected that capital costs and operating costs will improve significantly once the existing plants achieve consistent operations and new plants are built based on the learnings from operating the first commercial plants.

Uncertainty

There remains significant uncertainty with respect to the commercialization of the technology. The plants built 3 to 5 years ago have experienced some unforeseen technical and economic challenges which has slowed the development progress.

Additional Remarks

The significant cellulosic plants that have been built are shown in the following table [11].

Name	Annual Capacity	Feedstock	Comment
Abengoa Bioenergy Biomass of Kansas	90 million litres	corn stover, wheat straw, switch grass	Idle
Beta Renewables	50 million litres	wheat straw, rice straw, arundo donax, poplar	Idle
DuPont	110 million litres	Corn Stover	Idle
GranBio	80 million litres	Sugarcane bagasse and straw	Operational
POET-DSM	80 million litres	Corn Stover and corn cobs	Operational
Raizen Energia	40 million litres	Bagasse	Operational

Table 1 Cellulosic Ethanol Plants

Quantitative Description

The available quantitative data that is available on the technology is mostly from third parties and not from the technology providers or plant operators. Actual plant data is considered confidential by the process developers.

The process itself is essentially identical to the starch ethanol process with the primary difference being the length of glucose polymer chain.

The process involves two chemical reactions. In the first, cellulose is hydrolyzed to glucose as shown below. One of the technical challenges with the process is making the cellulose component of the lignocellulosic feedstock accessible for the hydrolysis process.

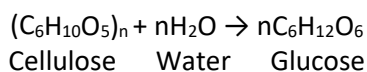

The glucose is then fermented with yeast to ethanol and carbon dioxide.

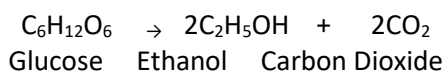

Typical Plant Size

The plants that have been built have been in the 50 to 100 million litres per year range. Some of the techno economic studies that have been done use plant sizes of 200 million litre per year (140 MW) [1]. As with the 1st generation plants it is likely that plant sizes will increase as more plants are built and experience is gained with the technology.

Input and Output

The primary input is the feedstock. Most technology developers (but not all) utilize the non fermentables to provide the thermal energy and electric power for the plant and some have excess power available for sale.

The plants also consume enzymes, yeast, and a number of process chemicals. Enzymes can be purchased or produced on site using a portion of the sugar produced by hydrolysis. Enzyme consumption is much higher than it is in a 1st generation ethanol plant. In the 2012 state of the art case [1] reported the consumption of 0.38 kg of chemicals for every kilogram of ethanol produced. It is likely that this has been decreased with additional development work but NREL have not published an updated state of the art report.

The plants produce ethanol and in some cases electricity. Some developers propose to sell a fertilizer product instead of producing electricity. The data used for the Sankey diagram is shown in the following table [1].

Parameter	Input [kg]	Output
Feedstock	3.38	
Chemicals	0.38	
Sulfuric acid	0.072	
Sodium hydroxide	0.082	
Ammonia	0.042	
Corn steep liquor	0.048	
Diammonium phosphate	0.005	
Sorbitol	0.002	
Glucose	0.103	
Host nutrients	0.002	
Sulfur dioxide	0.001	
Ethanol		1 litre
Power		0.70 kWh

Table 2 Cellulosic Ethanol Inputs and Outputs

The current performance is not likely at this level. It has been assumed that the current yield is 80% of the value shown, the value can be achieved in 2030 and the 2050 value is 10% better.

Forced and Planned Outage

The existing operating plants have struggled with forced outages. The following figure shows the production rate versus time for three generations of logen's cellulosic technology [12]. The figure shows the difficulty in achieving design rates but also the progress that can be made with experience.

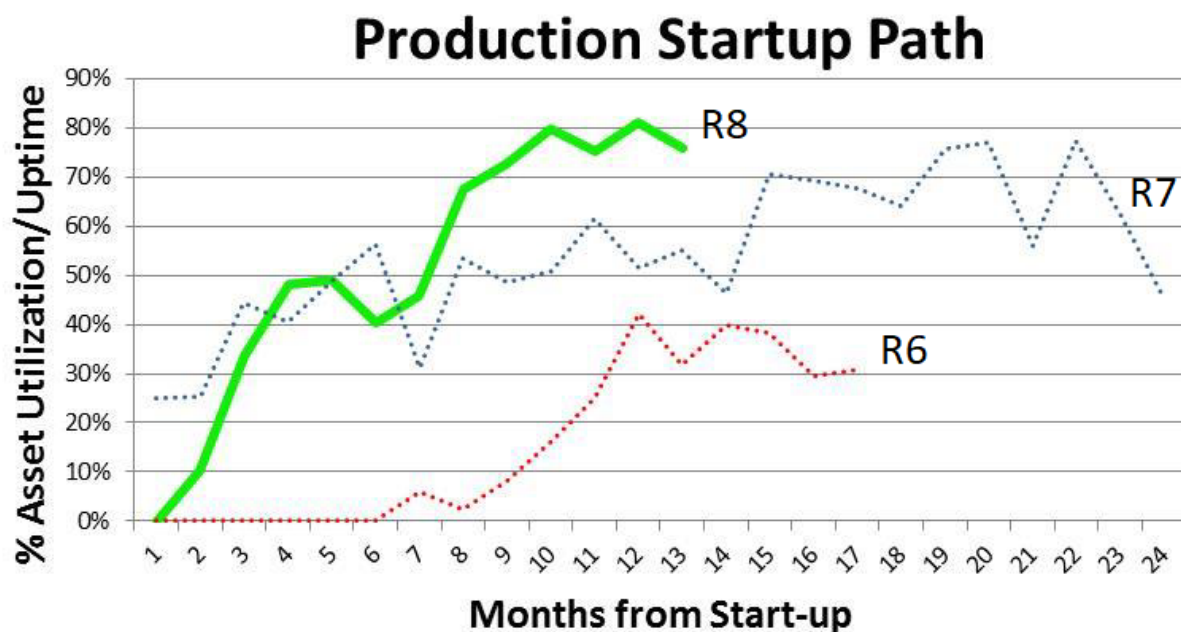

Figure 5 Cellulosic Ethanol Production Rates. The legends refer to different production lines and R8 is at the latest stage of development.

Both Iogen and Poet have stated that the initial operational challenges have been in the pre-treatment stage of the process. Severe fouling and flow restrictions have been reported in this section. Eventually it is expected that plants will be able to operate for 330 to 350 days per year with no forced downtime.

Technical Lifetime

Plant lifetimes should exceed 25 years, as the US and EU starch ethanol industries have demonstrated.

Construction Time

Due to the added complexity of the process construction times are expected to be 24 to 30 months.

Financial Data

There is very limited financial data available on the process. The available information is a combination of techno-economic studies and the published capital costs of the commercial plants.

Investment Costs

Lynd et al (2017) reported the size and capital expenditures for the pioneering plants [13]. The information is shown in the following table.

Company	Location	Feedstock	Capacity, million litres	Capital Expenditure, Million US\$	Capital, \$/litre
Abengoa	Kansas, USA	Straw	95	444.6	4.7
Beta Renewables	Crescentino, Italy	Straw	51	171	3.4

DuPont	Iowa, USA	Corn stover	114	500	4.4
Granbio	Alagoas, Brazil	Bagasse, straw	82	265	3.2
POET/DSM	Iowa, USA	Corn stover	76	275	3.6
Raizen	Piracicaba, Brazil	Bagasse, straw	40	102	2.5
Average			76	293	3.9

Table 3 Capital Costs

The capital costs for the pioneering plants have been about six to seven times higher than 1st generation plants. While de Jong [14] did not report a capital growth factor for this technology, the factors for other biomass feedstock technologies was in the range of 0.4 suggesting that the nth plants might have capital costs of \$1.60/litre.

The NREL capital cost for the nth plant [1] was \$381 million for a 207 million litre plant (\$1.84/litre), in line with the capital growth factor adjusted costs of the pioneering facilities.

Irena [15] reported capital costs on the range of 2,000 to 3,500 US\$/kW ethanol (1.5 to 2.6 US \$/annual litre). They see this being reduced to 1,200 to 2,300 US \$/kW ethanol by 2045.

The EU Sub Group on Advanced Biofuels [16] reported capital costs 3,300 €/kW but noted that the first plants ranged from 2,380 to over 6,700 €/kW.

The capital costs are 3 to 5 times higher than 1st generation plants and vary widely between plants. The current estimated range is €1.5 to €2.5/litre (€3,300 to 5,600/KW).

Operating and Maintenance Costs

The NREL operating and maintenance costs are summarized in the following table [1].

Parameter	Euro/litre
Variable operating costs, ex feedstock	0.083
Fixed costs	0.04

Table 4 Operating and Maintenance Costs

These are nth plant estimates which are unlikely to be achieved for the pioneering plants although there is no published information on the performance of the pioneering plants.

Start-up Costs

Start-up costs are included in the operating costs.

Technology Specific Data

The ethanol properties of cellulosic ethanol are identical to the 1st generation ethanol properties.

Data sheet

The quantitative data for the cellulosic ethanol process are summarized in the following table.

Technology	Cellulosic Ethanol										
	2015	2020	2030	2040	2050	Uncertainty (2020)		Uncertainty (2050)		Note	Ref
						Lower	Upper	Lower	Upper		
Energy/technical data											
Typical total plant size 1,000 tonnes/year	60	60	150	175	200	50%	150%	50%	150%	A, B	9
Typical total plant size, MW	55	55	130	155	180	50%	150%	50%	150%	A, A1, B	9
Inputs											
Feedstock Consumption, MWh/MWh Total Input	1	1	1	1	1	90%	150%	90%	150%	C	1
Outputs											
Ethanol Output, MWh/MWh Total Input	0.29	0.29	0.37	0.39	0.40	80%	120%	80%	120%	C	1
Electricity Output, MWh/MWh Total Input	0.04	0.04	0.05	0.05	0.06	80%	120%	80%	120%	C	1
Forced outage (%)	4	4	2	0	0						
Planned outage (weeks per year)	2	2	2	2	2						
Technical lifetime (years)	25	25	25	25	25						
Construction time (years)	2	2	2	2	2						
Financial data											
Specific investment (M€ /MW Ethanol)	5.69	5.69	2.56	2.25	2.13	75%	150%	75%	150%	D, G	1, 10, 11
- equipment (%)	75	75	75	75	75						
-installation (%)	25	25	25	25	25						
Fixed O&M (M€ /MW/year Ethanol)	0.114	0.114	0.057	0.057	0.057	95%	200%	95%	200%	F, G	1
Variable O&M (€ /MW Ethanol)	27.1	27.1	13.6	13.4	13.6	95%	200%	95%	200%	F, G	1
Start-up (M€ /1,000 t Ethanol)	0	0	0		0					E	
Technology specific data											
Specific energy content (GJ/ton)	26.9	26.9	26.9	26.9	26.9						
Specific density (kg/l) or (ton/m ³)	0.79	0.79	0.79	0.79	0.79						
Specific investment (M€ /1,000 t Ethanol)	5.06	5.06	2.28	2.00	1.90	75%	150%	75%	150%	D, G	1, 10, 11
- equipment (%)	75	75	75	75	75						
-installation (%)	25	25	25	25	25						
Fixed O&M (M€ /1,000 t Ethanol)	0.101	0.101	0.051	0.051	0.051	95%	200%	95%	200%	F, G	1
Variable O&M (M€ /1,000 t Ethanol)	0.203	0.203	0.101	0.100	0.101	95%	200%	95%	200%	F, G	1
Start-up (M€ /1,000 t Ethanol)	0	0	0	0	0					E	

Notes:

- A. The plant size is assumed based on the plants sizes of existing ethanol plants.
- A1. This value is the hourly rating and has been calculated as if the unit produces at capacity and was in operations 8,000 h/year.
- B. The plant size uncertainty represents the current range in the market.
- C. Not all process developers are attempting to maximize ethanol output; this can result in higher feedstock consumption but lower chemical use. Co-product production is higher if the ethanol yield is low.
- D. There is a wide range of reported capital costs for the existing plants and a wide range in the cost of future plants.
- E. Start-up costs are included in the operating costs.
- F. O&M costs are based on the nth plant. There are no public estimates for the costs from current plants. It has been estimated that they are twice the values for the nth plants. This may be optimistic unless the on line performance can be improved.
- G. M €/k tonne is million euro per 1,000 tonnes

References

- [1] Tao, L., Schell, D., Davis, R., Tan, E., Elander, R. and Bratis, A. 2014. NREL 2012 Achievement of Ethanol Cost Targets: Biochemical Ethanol Fermentation via Dilute-Acid Pretreatment and Enzymatic Hydrolysis of Corn Stover. NREL/TP-5100-61563. <https://www.nrel.gov/docs/fy14osti/61563.pdf>
- [2] Kacelle. 2014. Bringing cellulosic ethanol to industrial production at Kalundborg, Denmark. <https://biorefiningalliance.com/wp-content/uploads/2014/12/KACELLE-PUBLISHABLE-SUMMARY-web.pdf>
- [3] POET-DSM achieves cellulosic biofuel breakthrough. Nov 2017. <http://poetdsm.com/pr/poet-dsm-achieves-cellulosic-biofuel-breakthrough>
- [4] Thakrar, A. 2017. PROJECT LIBERTY: Lessons learned in commercializing cellulosic biofuels. Presented at 6TH International Conference on Lignocellulosic Ethanol. Brussels, Sept 2017. <https://ec.europa.eu/energy/en/events/6th-international-conference-ethanol-lignocellulosics>.
- [5] Van der Meij, R. 2017. A venture capitalist's view on investment in lingo-cellulosic ethanol. Presented at 6TH International Conference on Lignocellulosic Ethanol. Brussels, Sept 2017. <https://ec.europa.eu/energy/en/events/6th-international-conference-ethanol-lignocellulosics>.
- [6] Merritt, M. 2017. Real Progress in Cellulosic Biofuel. *Biofuels, Bioprod. Bioref.*, 11: 943-944. <https://doi.org/10.1002/bbb.1837>
- [7] Beta Renewables. Oct 2017. The Alessandria court admitted the Gruppo Mossi Ghisolfi companies to the "concordato preventivo". <http://www.betarenewables.com/en/media-relations/news-detail/32>
- [8] DuPont to sell cellulosic ethanol plant in blow to biofuel. Nov 2017. <https://www.reuters.com/article/us-dowdupont-ethanol/dupont-to-sell-cellulosic-ethanol-plant-in-blow-to-biofuel-idUSKBN1D22T5>
- [9] Clariant. 2017. Clariant And Enviral Announce First License Agreement on Sunliquid® Cellulosic Ethanol Technology. <https://www.clariant.com/en/Corporate/News/2017/09/Clariant-and-Enviral-announce-first-license-agreement-on-sunliquid-cellulosic-ethanol-technology>
- [10] Clariant. 2017. Clariant to Build Flagship Sunliquid® Cellulosic Ethanol Plant in Romania. <https://www.clariant.com/en/Corporate/News/2017/10/Clariant-to-build-flagship-sunliquid-cellulosic-ethanol-plant-in-Romania>
- [11] IEA Bioenergy Task 39. Cellulosic Ethanol Plants. <http://demoplants.bioenergy2020.eu/>

-
- [12] Brian Foody. 2016. Scaling Up Cellulosic Biofuels, Ideas & Experience. Presented at Scaling Up, Ottawa, Ontario, Nov 15, 2016.
- [13] Lee R Lynd, Xiaoyu Liang, Mary J Bidy, Andrew Allee, Hao Cai, Thomas Foust, Michael E Himmel, Mark S Laser, Michael Wang, Charles E Wyman. 2017. Cellulosic ethanol: status and innovation, In Current Opinion in Biotechnology, Volume 45, 2017, Pages 202-211, ISSN 0958-1669, <https://doi.org/10.1016/j.copbio.2017.03.008>
- [14] de Jong, S., Hoefnagels, R., Faaij, A., Slade, R., Mawhood, R. and Junginger, M. 2015. The feasibility of short-term production strategies for renewable jet fuels – a comprehensive techno-economic comparison. Biofuels, Bioprod. Bioref., 9: 778–800. <https://www.doi.org/10.1002/bbb.1613>
- [15] Irena. 2016. Innovation Outlook. Advanced Liquid Biofuels. http://www.irena.org/DocumentDownloads/Publications/IRENA_Innovation_Outlook_Advanced_Liquid_Biofuels_2016.pdf
- [16] Sub Group on Advanced Biofuels. 2017. Cost of Biofuel. http://platformduurzamebiobrandstoffen.nl/wp-content/uploads/2017/07/2017_SGAB_Cost-of-Biofuels.pdf

97 Methanol from Biomass Gasification

Contact Information:

Danish Energy Agency: Jacob Hjerrild Zeuthen, jhz@ens.dk and Filip Gamborg, fgb@ens.dk

Author: Don O'Connor – (S&T)² Consultants Inc.

Publication date

August 2018

Amendments after publication date

Date	Ref.	Description
12 2018		Datasheet revised

Qualitative Description

The front end of this process is identical to the gasification process in the previous description. The production of methanol from biomass is a two-step process. In the first step the solid biomass is converted into a bio-syngas and in the second step this syngas is further converted into methanol.

Gasification is a process that converts organic or fossil-based carbonaceous materials at high temperatures (>700°C), without combustion, with a controlled amount of oxygen and/or steam into carbon monoxide, hydrogen, and carbon dioxide (syngas). Stoichiometry for methanol production of syngas requires the ratio of H₂/CO to equal 2. The H₂/CO ratio can be lowered to some extent by the reverse water-gas shift reaction

Depending on the catalyst supplier, the methanol synthesis reaction is normally carried out at about 40 to 120 bar and 200 to 300°C.

Methanol is not the only product that could be produced by this route. Dimethyl Ether (DME) could also be produced instead of methanol or in an additional process step. The methanol could also be further processed into gasoline.

Brief Technology Description

The biomass could be agricultural or forestry residues. There is a wide range in the design of gasifiers used for biomass. Different technological solutions can be implemented in order to obtain different plant configurations; in particular, the mode of contact of the biomass with the gasification agent may be in counter-current, or co-current, or crossflow, and the heat can be transferred from the outside or directly in the reactor using a combustion agent; the residence time can be in the order of hours (static gasifiers, rotary kiln) or minutes (fluidized bed gasifiers). Different gasifier designs are better suited to different feedstocks and gas needs. Gasification is further described in Biomass Gasification - general introduction and the subsequent chapters.

The syngas to methanol reactions are practised commercially mostly using natural gas to produce the syngas but there are a few plants that gasify coal to produce the syngas. While the scale of commercial plants is

large there have been some small scale methanol plants built where large natural gas reserves are not available.

The overall process is shown in the following simplified process flow diagram.

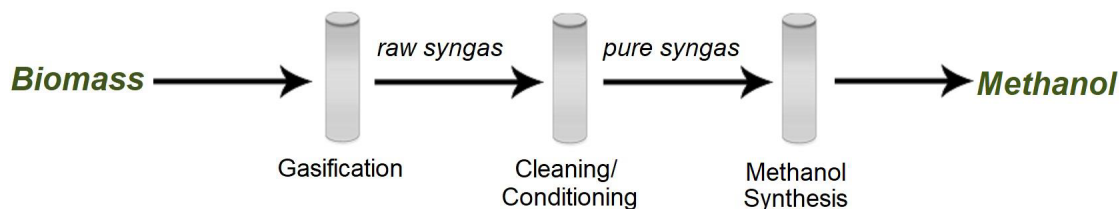

Figure 1 Biomass to Methanol Process

Input

The primary input for most process is just the biomass. The reactions are exothermic and generate enough heat for the process and in some cases also enough heat to produce the power required for the system. In other examples power is purchased for the process.

Output

The plants produce methanol and in some cases could produce some excess power and/or steam for sale.

Energy Balance

The energy balance for a biomass to methanol system is shown in the following figure [1].

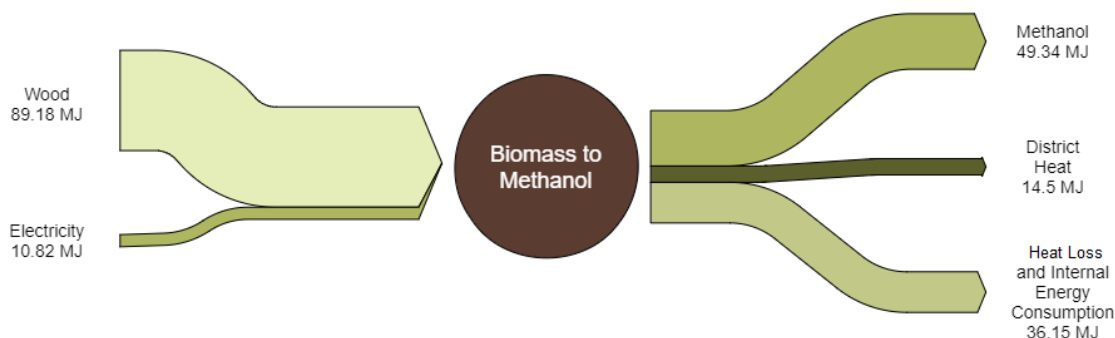

Figure 2 Bio Methanol Energy Balance

There are two potential means to recover some of the waste heat. The plants use some of the process heat to produce electricity for the plant use and potentially a small amount to be exported. Steam from the exit of the final steam turbine would be available for other uses. This could have a temperature between 150 and 185C depending on the design. There may also be some opportunity to recover some lower grade heat as the syngas is conditioned prior to synthesis. Details of the potential for energy recovery are not reported in most of the recent techno-economic studies published.

Other biomass to methanol systems have been proposed that offer higher efficiencies [2] [3]. The GreenSynFuels project provided the energy balance for both a traditional biomass to methanol plant and one integrated with a solid oxide electrolyzer to produce hydrogen to provide a better CO to H₂ ratio for the methanol synthesis stage. Clausen [3] provided information for a highly optimized biomass to methanol process. The energy balances for these systems are shown in the following figures.

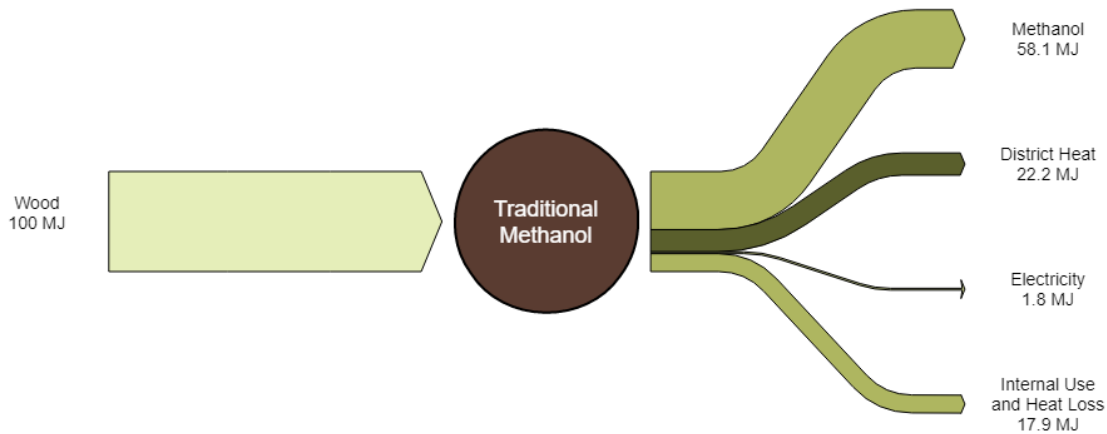

Figure 3 GreenSynFuels Traditional Methanol Plant

This plant produces electricity instead of consuming it and the methanol production rate is slightly higher per unit of wood consumed. The following figure shows the highly optimized system described by Clausen [3]. The methanol production rate is 8% higher per unit of feedstock.

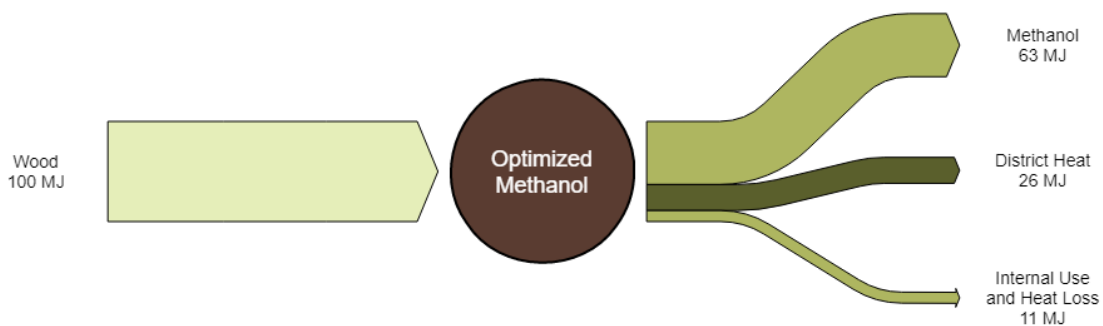

Figure 4 Optimized Biomass to Methanol Plant

This final energy balance considers the supplementation of hydrogen to alter the carbon to hydrogen ration of the syngas to better match the methanol synthesis requirements. It produces more methanol per unit of energy input and has a much better carbon efficiency.

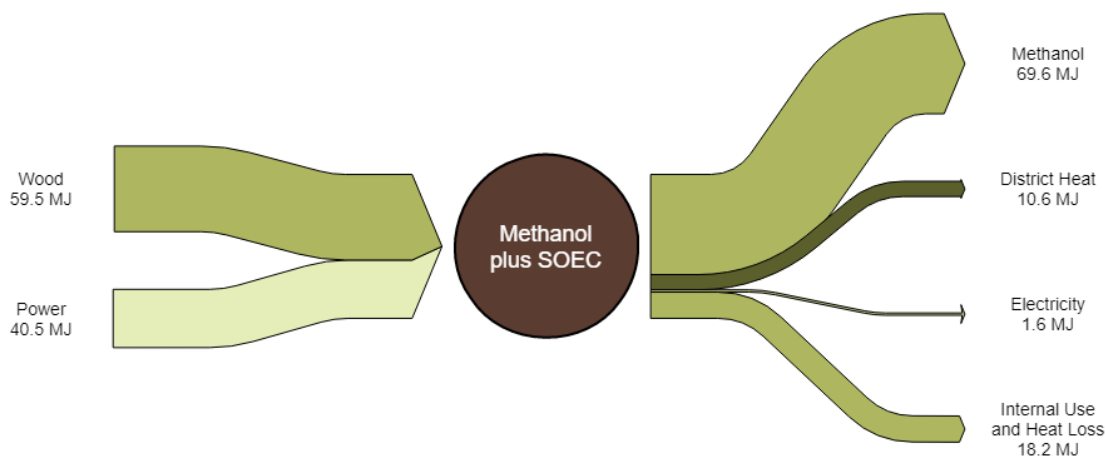

Figure 5 Hybrid Biomass to Methanol Plant

Typical Capacities

There are currently no commercial biomass to methanol plants in operation. In the past OCI operated a former natural gas to methanol plant on crude glycerine from biodiesel plants as the feedstock in the Netherlands but that operation is now processing natural gas again. There was also a bioDME pilot plant operated in Sweden for a number of years where methanol production was an intermediate product (Chemrec) [9]. It gasified black liquor from a pulp mill rather than biomass.

Commercial plants would likely be similar in size to the biomass to diesel and jet technology that was discussed in the previous section, with an early commercial plant consuming 500 to 1000 tpd of biomass and producing 125 to 250 million litres/year.

Eventually plants could be built larger with feedstock availability being the limiting factor.

Regulation Ability

While biomass gasifiers can operate down to about 35% of rated capacity, commercial methanol plants usually operate at steady state conditions close to the design capacity. Commercial methanol plants can take 2-3 days to reach full production so starting and stopping the plants is generally not an option for regulating capacity. Smaller scale systems with different catalysts may have better regulation capabilities than the large scale plants.

Space Requirements

Space requirements will be similar to the space for the biomass to diesel and jet pathway, on an area per feedstock basis. The area per volume of fuel produced will be lower due to the lower energy density of methanol compared to diesel and jet fuel.

Based on the Velocys commercial FT liquids plant the area requirements for biomass to methanol are about 0.16 ha/million litres of methanol.

Advantages/Disadvantages

Methanol is not widely used as a transportation fuel today but there are several potential emerging applications that are generating some interest. One is the use of methanol as a hydrogen carrier for fuel cell vehicles such as those developed by Serenergy in Denmark. There is also some interest in methanol as a marine fuel to meet the new IMO sulphur limitations. In China there is some methanol gasoline blending with 10 and 15% methanol. Low level methanol blends (3%) with a co-solvent have been used in the UK in recent years. Methanol has also been used in blends with ethanol and gasoline in performance vehicles.

Methanol from biomass can be used for the same applications as fossil methanol, while reducing GHG emissions.

Much of the world's methanol is produced from stranded natural gas and is very low cost. It will be difficult for biomass to methanol to compete against these projects on only an economic basis.

Environment

Biomass to methanol should have a very low GHG emission profile, especially when they are designed to be self-sufficient in electric power.

Methanol as a fuel is a biodegradable product.

Research and Development Perspective

Biomass gasification for methanol production from wood or straw is a category 2 technology, a pioneer phase technology with limited applications to date. The technology has been proven to work through demonstration facilities or semi-commercial plants. However, due to the limited application, the price and performance is still attached with high uncertainty, since development and customization is still needed. The technology still has a significant development potential.

This technology pathway is the combination of two commercial systems. There has been considerable development work on biomass gasification in Europe over the past several decades but there has not been a commercial break through yet.

The production of a synfuel from a biomass gasification system is a more demanding application than the use of the gas in an engine or in an external combustion system. It is reported that the Chemrec BioDME plant operated for more than 11,000 hours between 2011 and 2016 [4]. Production during that time was reported to be 1000 tonnes of DME. The capacity of the plant was 165 kg/hour which works out to 6,000 hours of operation.

More work is required on the integration of the two main systems.

Examples of Market Standard Technology

There are no market standard technologies. There is a biomass gasification to methanol proposal for a plant in Sweden, Värmland Methanol [5]. The plant is cost estimated at approximately 350 million Euro and will

produce 375,000 liters of methanol per day (130 million litres/year). As a "byproduct" 15 MW of district heating is obtained.

An EPC contract with ThyssenKrupp Industrial Solutions of Germany has been signed. The project was proposed in 2009 but has been unable to raise financing for the project. ThyssenKrupp Industrial Solutions do have experience and expertise in gasification and methanol production technologies.

Enerkem, a Canadian company has operated a municipal solid waste (MSW) gasification to methanol production system in Edmonton Alberta for the past two years. The company is focussed on MSW as a feedstock due to the favourable economics. The Edmonton plant is in the process of being converted to produce ethanol rather than methanol from the syngas.

Predication of Performance and Cost

The prediction of performance and cost is based on published techno-economic papers rather than on actual plant performance.

Uncertainty

There is a high level of uncertainty for the technology given the state of development and the fact that there are no operating plants in the world at this time.

Additional Remarks

There is a Danish Methanol Association promoting bio methanol but the syngas is produced from biogas from anaerobic digestion and not from solid biomass. These systems will be smaller due to the resource availability but with less technology risk since there is no biomass gasification involved.

Quantitative Description

The available quantitative data that is available on the technology is mostly from third parties and not from the technology providers or plant operators. No actual plant data is available.

There are three basic reactions that occur in the process. The first reaction breaks the biomass down, at high temperature and low oxygen, to a combination of hydrogen, carbon monoxide and carbon dioxide. A simplified reaction is shown below. Actual biomass has highly variable composition and complexity with cellulose as one major component.



Note: The above reaction uses glucose as a surrogate for cellulose.

Stoichiometry for methanol production of syngas requires the ratio of H₂/CO to equal 2. The product gases are then subjected to the water-gas shift reaction to increase the quantity of hydrogen. The equilibrium for this reaction is temperature dependent which controls the CO to CO₂ ratio.

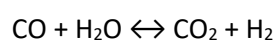

Carbon monoxide and hydrogen react over a catalyst to produce methanol. Today, the most widely used catalyst is a mixture of copper and zinc oxides, supported on alumina. At 50–100 bar and 250 °C, the reaction is characterized by high selectivity (>99.8%):

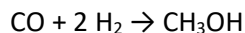

Compared to the production of diesel and jet fuel from the gasification of biomass, this pathway requires a lower H₂/CO ratio and operates at lower temperatures but higher pressures.

Typical Plant Size

As with the biomass to diesel and jet process, the plant size will be determined by the feedstock availability. The proposed plant in Sweden would produce 130 million litres of methanol per year (65 MW) from 1,100 tpd of wood [6]. It is not stated but this is likely on a wet basis (660 dry tpd).

NREL undertook a techno-economic analysis of a wood to methanol plant [7]. They based the plant on 2000 tpd of feedstock producing 380 million litres per year (200 MW).

Input and Output

The input and output of a typical system are shown in the following table [2]. These will be nth plant values. Pioneering plants typically have a lower efficiency.

Parameter	Input	Output
Wood, dry	100 MJ	
Power		1.8 MJ
Methanol		58.2 MJ

Table 1 Inputs and Outputs

Forced and Planned Outage

The plants are expected to operate for 350 days per year. Wood gasifiers are capable of operating at these rates as shown earlier and fossil methanol plants are also capable of operating at these rates. Forced outages are expected to be minimal.

Technical Lifetime

Due to the maturity of the technology, plant lifetime is estimated to be 20 years for plants build before 2025. Hereafter, it is expected to increase to 25 years.

Construction Time

Construction time for the technology is expected to be about 24 -36 months.

Financial Data

Techno-economic analyses of standalone biomass gasification to methanol systems have been published [1] [7]. These are used as the basis for the financial analysis and where possible compared to the published data for the proposed Swedish plant.

Investment Costs

The estimated capital cost of the 270,000 tonne per year methanol plant is 369 million Euros [1] (0.91 €/litre). This is the same cost as the Värmland Methanol plant but it is more than twice the capacity. This is a reasonable ratio between the nth plant and a pioneering plant.

The NREL plant [5] was \$259 million in 2007 dollars, this would be €0.75/litre.

The EU Sub Group on Advanced Biofuels reported plant sizes in the range of 100 to 200 MW and capital costs of €1,850 to 3,450/kW depending on the scale (€1.00/litre to €1.85/litre).

The capital costs range from €0.75/litre (NREL) to €2.70/litre (Värmland).

Operating and Maintenance Costs

Anderson only presented the combined operating and maintenance costs (Costs for wages, insurance for employees and chemical, water and ash disposal) of €0.10/kg (€0.08/litre). NREL did not provide a breakdown of the operating costs.

Start-up Costs

The start-up costs are included in the costs reported.

Technology Specific Data

Some the properties of methanol are shown in the following table.

Property	Value
Density, kg/m ³	791
LHV, MJ/kg	19.9
LHV, MJ/litre	15.7
Oxygen content	50 wt%
Blending Octane number	~115
Flash point, C	12

Table 2 Methanol Properties

Data sheet

The quantitative data for the biomass to methanol process are summarized in the following table.

Technology	Bio Methanol										Note	Ref
	2015	2020	2030	2040	2050	Uncertainty (2020)		Uncertainty (2050)				
						Lower	Upper	Lower	Upper			
Energy/technical data												
Typical total plant size 1,000 t Methanol/year	100	100	200	250	300	50%	200%	50%	125%	A, B	3, 5, 6	
Typical total plant size, MW	65	65	130	165	195	50%	200%	50%	125%	A, A1, B	3, 5, 6	
Inputs												
Feedstock Consumption, MWh/MWh Total Input	1	1	1	1	1	90%	150%	90%	120%		1	
Outputs												
Methanol Output, MWh/MWh Total Input	0.58	0.58	0.61	0.63	0.65	100%	133%	100%	133%	D	1	
District heat Output, MWh/MWh Total Input	0.22	0.22	0.22	0.22	0.22	80%	125%	80%	125%	D	1	
Electricity Output, MWh/MWh Total Input	0.02	0.02	0.02	0.02	0.02	80%	125%	80%	125%	D	1	
Operational parameters												
Forced outage (%)	4	4	0	0	0							
Planned outage (weeks per year)	2	2	2	2	2							
Technical lifetime (years)	25	20	20	20	20							
Construction time (years)	2.5	2.5	2.5	2.5	2.5							
Financial data												
Specific investment (M€ /MW Methanol)	5.26	5.26	2.92	2.12	1.46	50%	100%	80%	120%	F	1, 3, 5, 6	
- equipment (%)	75	75	75	75	75							
-installation (%)	25	25	25	25	25							
Fixed O&M (M€ /MW/year Methanol)	0.058	0.058	0.039	0.038	0.039	90%	110%	90%	110%	E, F	1	
Variable O&M (€ /MWh methanol)	20.4	20.4	13.6	13.6	13.6	90%	110%	90%	110%	E,,F	1	
Start up (M€ /1,000 t Methanol)	0	0	0		0							
Technology specific data												
Specific energy content (GJ/ton) methanol	20.1	20.1	20.1	20.1	20.1							
Specific density (kg/l) or (ton/m3)	0.79	0.79	0.79	0.79	0.79							
Specific investment (M€ /1,000 t Methanol)	3.42	3.42	1.90	1.40	0.95	50%	100%	80%	120%	F	1, 3, 5, 6	
Fixed O&M (M€ /1,000 t Methanol)	0.038	0.038	0.025	0.025	0.025	90%	110%	90%	110%	E, F	1	
Variable O&M (M€ /1,000 t Methanol)	0.114	0.114	0.076	0.076	0.076	90%	110%	90%	110%	E,,F	1	
Start up (M€ /1,000 t Methanol)	0	0	0	0	0							

Notes:

- A. The plant size range is assumed based on the proposed Värmlands plant and the NREL nth plant.
- A1. This value is the hourly rating and has been calculated as if the unit produces at capacity and was in operations 8,000 h/year.
- B. Feedstock availability is likely to determine the maximum plant size.
- C. Some plants may produce their own power and have no power imports.
- D. Plants that produce their own power will have much lower heat available to district heat.
- E. Assumed a 25/75 split on fixed to variable operating costs.
- F. M €/k tonne is million euro per 1,000 tonnes

References

- [1] Andersson, J., Lundgren, J., and Marklund, M. 2014. Methanol production via pressurized entrained flow biomass gasification – Techno-economic comparison of integrated vs. stand-alone production, In Biomass and Bioenergy, Volume 64, 2014, Pages 256-268, ISSN 0961-9534, <https://doi.org/10.1016/j.biombioe.2014.03.063>
- [2] Danish Technology Institute. 2011. GreenSynFuels. EUDP project journal number: 64010-0011. http://serenergy.com/wp-content/uploads/2015/11/GreenSynFuels_report_final.pdf
- [3] Clausen, L. 2014. Integrated torrefaction vs. external torrefaction – A thermodynamic analysis for the case of a thermochemical biorefinery. Energy, Volume 77, Pages 597-607. <https://doi.org/10.1016/j.energy.2014.09.042>.
- [4] IEA Bioenergy Task 39. 2016. IEA-Bioenergy-Task-39-Newsletter-Issue-42-April-2016. <http://task39.sites.olt.ubc.ca/files/2012/01/IEA-Bioenergy-Task-39-Newsletter-Issue-42-April-2016.pdf>
- [5] Värmlands Metanol AB. <http://www.varmlandsmetanol.se/Om%20Projektet.htm>
- [6] Värmlands Metanol AB. 2016. Metanol från skog - ett miljövänligt drivmedel. <http://www.varmlandsmetanol.se/dokument/Folder%20VM%20sept%202016.pdf>
- [7] NREL. 2011. Technoeconomic comparison of biofuels: ethanol, methanol, and gasoline from gasification of woody residues. <https://www.nrel.gov/docs/fy12osti/52636.pdf>
- [8] Sub Group on Advanced Biofuels. 2017. Cost of Biofuel. http://platformduurzamebiobrandstoffen.nl/wp-content/uploads/2017/07/2017_SGAB_Cost-of-Biofuels.pdf
- [9] http://www.biodme.eu/wp/wp-content/uploads/DME5_BioDME_Salomonsson.pdf

98 Methanol from Power

Contact Information:

Danish Energy Agency: Jacob Hjerrild Zeuthen, jhz@ens.dk and Filip Gamborg, fgb@ens.dk

Author: Don O'Connor – (S&T)² Consultants Inc.

Publication date

August 2018

Amendments after publication date

Date	Ref.	Description
12 2018		Datasheet revised

Qualitative Description

Methanol from power is a concept that combines carbon dioxide with hydrogen produced by electrolysis to produce methanol. There is one plant in operation in Iceland (Carbon Recycling International, CRI). The plant produces 5 million litres per year of methanol. The plant uses electricity from the grid to make hydrogen which is converted into methanol in a catalytic reaction with carbon dioxide (CO₂). The CO₂ is captured from flue gas released by a geothermal power plant located next to the CRI facility. The origin of the flue gas is geothermal steam emissions.

There are many possible sources of CO₂ (power plants, fertilizer producers, ethanol plants) and variations of the concept have been proposed where renewable electricity sources replace the grid power used in Iceland. Smaller scale systems could use CO₂ from biogas plants as an alternative to methanation.

The methanol could also be further processed into DME or gasoline with available commercial technologies.

Brief Technology Description

Methanol is produced commercially mostly via steam reforming of natural gas. In that process the methane is reformed into hydrogen, carbon monoxide and carbon dioxide and then the gases are re-combined to produce methanol. In the power to methanol system separate sources of hydrogen and carbon dioxide are combined to produce the methanol as shown in the following figure.

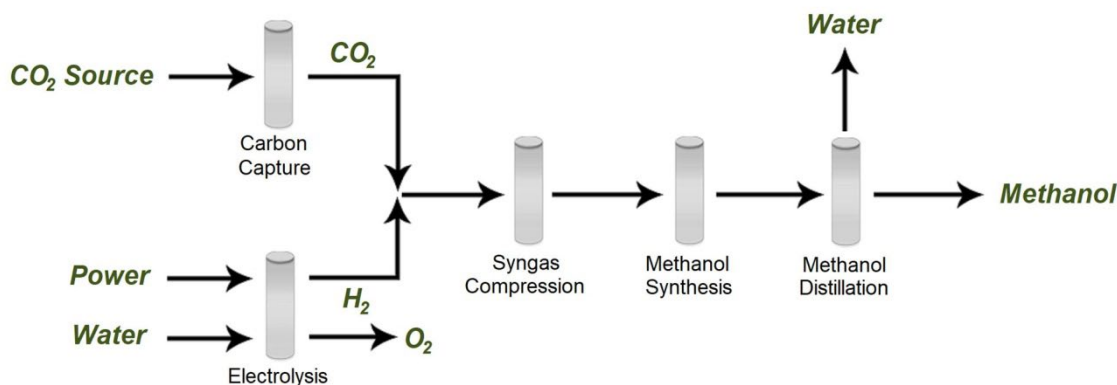

Figure 1 Methanol to Power Process

Electricity is used to produce the hydrogen and to compress the gases prior to the methanol synthesis stage. The attractiveness of the process is that if low carbon power is used the produced methanol has a low carbon footprint.

Methanol can be used in a number of applications. Low levels of methanol (3-5%) have been blended with gasoline and co-solvents in Europe and North America in the past. Higher level blends (M85) has been used in flex fuel vehicles. Methanol is also a good source of hydrogen for fuel cell vehicles. The Danish methanol fuel cell manufacturer SerEnergy is now producing a commercial reformed methanol fuel cell vehicle with a driving range up to 800 km on a tank of methanol [1].

Input

The primary inputs to the system are electricity for hydrogen production and carbon dioxide. Alternatively the inputs could be carbon dioxide and hydrogen (where the hydrogen would be produced by electrolysis). The carbon dioxide can come from many different sources.

Output

The output from the system is methanol and water.

Energy Balance

The energy balance is shown in the following figure. In this case some of the waste heat is utilized internally for the CO₂ capture which is why the output totals less than 100 MJ [2] [3].



Figure 2 Methanol from Power Energy Balance

There are two sources of waste heat, from the electrolyzer used for hydrogen production and the methanol synthesis reaction. The electrolyzer energy loss is the larger of the two sources and is lower quality. The temperature of the waste heat will vary with the electrolyzer design and could range from 70 to 150°C for most designs. Solid oxide electrolyzers operate at much higher temperatures (700 to 800°C) and would have higher quality excess heat.

Typical Capacities

The one operating plant produces 5 million litres/year (4,000 tonnes of methanol, 3 MW) but it is as much a demonstration plant as a commercial operation. The EU funded MefCO₂ project brings together 8 partners throughout Europe together for one mission: to demonstrate the economic feasibility of valorising captured CO₂ by turning it into a versatile platform chemical and renewable fuel such as methanol using hydrogen produced from renewable energy surplus. Their business case foresees plants from 4,000 to 50,000 tonnes per year, with larger plants being possible depending on the availability of CO₂ [4].

Atsonios et al [5] investigated the technical and economic aspects of methanol production through the power to methanol process. Their plant capacity was limited by the size of the electrolysis unit at 140 MWe. This would produce about 120,000 t of methanol per year. A facility this size would consume 165,000 t/year of CO₂.

The 90 commercial methanol plants in the world have an average capacity of 1.2 million tonnes per year [6]. The power to methanol plants are considerably smaller than this and may be limited both by the availability of CO₂ and the size of electrolyzers, although large electrolysis systems can be built with multiple electrolyzer stacks

Regulation Ability

The electrolyzers [7] have excellent load following capability and can respond to large load (100 to 25% of capacity) changes within a fraction of a second. The commercial natural gas methanol production process can take several days to reach operating capacity as both the natural gas reforming stage and the methanol synthesis stages operate at high temperature and pressure.

A power to methanol process won't have the natural gas reforming stage but the methanol synthesis stage still operates at about 300 C and 85 bar of pressure. If this stage is not operated at a continuous rate there will be significant loss of overall efficiency for the process.

Space Requirements

A natural gas methanol plant has a space requirement of about 0.01 ha/million litres of methanol. Power to methanol plants will be smaller in overall size which will probably translate into more area per unit of production. The 4,000 tpy CRI plant in Iceland occupies 0.8 ha of land or 0.16 ha/million litres of methanol (3,000 m²/MW), although the site is not fully occupied.

Advantages/Disadvantages

With renewable power the GHG emissions for this pathway are extremely low. The technology will be limited in scale due to the supply of hydrogen and the availability of carbon dioxide.

The relatively small scale of the production systems will likely result in higher capital costs for the facilities. The methanol production process is not well suited to intermittent operation making it a poor match to wind and solar power generation without some storage capacity somewhere in the system prior to the methanol synthesis stage. Gotz [8] investigated the cost of hydrogen storage for the SNG pathway, which has a similar issue. He reported that for steady state operation of the methanation step the cost of hydrogen storage to deal with the intermittent power supply added 28% to the capital cost of the hydrogen supply electrolyzer.

Environment

The process is relatively benign, there are some catalysts used in the methanol synthesis stage but these can be recycled. The process produces water as well as the methanol.

The overall energy efficiency of the process is about 60%. The carbon dioxide input has no energy and thus all of the energy input into the process is supplied by the electricity. About 60% of the energy in the electricity ends up in the methanol, a small portion is used internally for thermal use and a third could be available as low grade heat for district heating systems.

Research and Development Perspective

Methanol production from power is a category 2 technology, a pioneer phase technology with limited applications to date. The technology has been proven to work through demonstration facilities or semi-commercial plants. However, due to the limited application, the price and performance is still attached with high uncertainty, since development and customization is still needed.

The technology is at the early stage of development although both the hydrogen production by electrolysis and the methanol synthesis are well established technologies. There is moderate development potential for the technology.

Examples of Market Standard Technology

Carbon Recycling International offers a standard Power-to-Liquids plant design with nominal 50,000 ton/yr methanol production capacity.

Carbon Recycling International

Holtasmari 1
201 Kopavogur
Iceland

Predication of Performance and Cost

Commercial scale plants will be at least an order of magnitude larger than the one operating facility and so the prediction of operating performance and costs at scale are uncertain. Some predictions of future costs have been made in the literature and these are discussed later in this section.

Uncertainty

The one demonstration plant has been operating for several years and the process steps have been commercially practiced for many years. The overall uncertainty is with the integration of the two

technologies, the potential need for a third stage to produce the required CO₂, and the scalability of the technologies.

Additional Remarks

The technology offers the opportunity to produce a liquid fuel (methanol) from electricity and is a potential means to address the range limitations of battery powered electric vehicles.

There are three types of electrolyzers that could be considered for the hydrogen supply. There are the traditional alkaline cells, the emerging polymer membrane systems and potentially solid oxide electrolysis cells [9]. The characteristics of each are summarized in the following table.

	Alkaline Cells AEC	Polymer Cells PEM	Solid Oxide Cells SOEC
Operating Temperature °C	60-80	60-80	750-950
Pressure	32 bar	100 bar potential	100 bar potential
Electrical Efficiency (HHV)	75-85%	10-85%	90%
Stage of Development	Commercial	Commercial	Under development
Products	H ₂ and O ₂	H ₂ and O ₂	H ₂ CO, and O ₂

Table 1 Electrolysis Systems

Energy balance should improve as the more efficient polymer and solid oxide electrolyzers are developed and employed.

There are also technologies available that can produce gasoline from methanol [10] which would allow the fuel to be used in existing gasoline powered vehicles. The methanol to gasoline process is very efficient so that the overall efficiency of power to gasoline is not significantly lower than power to methanol. Capital costs are higher due to the extra process step.

Quantitative Description

The quantitative description of the technology is provided below.

Typical Plant Size

Carbon Recycling International is offering process packages for 50,000 tpy plants. This is an order of magnitude scale up from the existing facility. Other analysis has been undertaken on plants of 140,000 tpy [5] and 440,000 tpy [8].

Input and Output

The process requires carbon dioxide and hydrogen to produce methanol. The hydrogen would be produced through electrolysis so electricity becomes the process input rather than hydrogen. The CO₂ could come from many different sources and depending on the source, there could be some thermal energy and electric power required to concentrate and purify the gas. For this work it has been assumed that the CO₂ is the process input and that it is of the required quality.

Parameter	Input	Output
-----------	-------	--------

Electricity	9.5 MWh	
Hydrogen	(0.14 t H ₂)	
Carbon Dioxide	1.4 t	
Methanol		1 tonne
Water		0.59 tonne
Oxygen		1.5 tonne

Table 2 Mass and Energy Flows

Forced and Planned Outage

The methanol synthesis stage of the process performs best when operated continuously, close to capacity and for extended periods of time. Forced outages need to be minimized and the plant should be able to operate at an average annual rate of 95% (15 days per year downtime).

Technical Lifetime

Methanol plants have long operating lifetimes. Due to the maturity of the technology, plant lifetime is estimated to be 20 years for plants build before 2025. Hereafter, it is expected to increase to 25 years.

Construction Time

Given the high temperature and pressure operating conditions for the methanol synthesis, the construction time could be expected to be two years.

Financial Data

The financial data is extracted from literature reports since no commercial plants have been built.

Investment Costs

The investment costs for three plant sizes from three reports are shown in the following table. The smallest plant has the highest capital costs, as one would expect. The medium and large plants have similar capital costs, reflecting either the uncertainty in estimating the costs or the lack of economies of scale once a certain plant size is arranged.

	Enea [12]	Atsonios [5]	Perez-Fortes [11]
Plant size, tpy	8,400	120,000	440,000
Total	3,571 €/t MeOH/yr	1,336 €/t MeOH/yr	1,285 €/t MeOH/yr

Table 3 Capital Costs

The capital costs range from €1.00/litre to €3.00/litre methanol.

Operating and Maintenance Costs

Atsonios estimates the O&M costs as 5% of fixed capital invested or €67 per tonne of methanol produced. Perez estimated the O&M costs as € 70 per tonne of methanol. It is assumed that 50% is fixed O&M and 50% is variable O&M.

Start-up Costs

Start-up costs are included in the O&M costs above, however this technology can take several days to start up and a similar time to shut down so the system performance will deteriorate significantly if the process is

started up and shut down frequently. Start-up and shut down is also the most likely time for a mechanical failure resulting in forced downtime.

Technology Specific Data

The power requirements to produce 1 GJ of methanol (LHV) are 470 kWh/GJ. Carbon intensities of power of less than 190 g CO₂/kWh will result in GHG emissions that are less than gasoline.

Data sheet

The technical information is summarized in the following table.

Technology	Power to Methanol										
	2015	2020	2030	2040	2050	Uncertainty (2020)		Uncertainty (2050)		Note	Ref
						Lower	Upper	Lower	Upper		
Energy/technical data											
Typical total plant size 1,000 t Methanol/year	5	50	100	125	150	50%	150%	50%	150%	A, B	4, 5, 11
Typical total plant size, MW	3	33	65	83	100	50%	150%	50%	150%	A, A1, B	4, 5
Inputs											
CO2 Consumption, t/t Methanol	1.37	1.37	1.37	1.37	1.37	100%	110%	100%	110%		5
Hydrogen Consumption, t/t Methanol	0.192	0.192	0.192	0.192	0.192	100%	110%	100%	110%		5
Electricity Consumption, MWh/MWh Total Inputs	1	1	1	1	1	90%	120%	95%	110%	C	2,3
Outputs											
Methanol Output, MWh/MWh Input	0.58	0.58	0.61	0.63	0.65	100%	133%	100%	133%	D	2,3
District Heating Output, MWh/MWh Total input	0.25	0.25	0.25	0.25	0.25	0%	100%	0%	100%	E	2,3
Operational data											
Forced outage (%)	4	4	0	0	0						
Planned outage (weeks per year)	2	2	2	2	2						
Technical lifetime (years)	25	20	20	20	20						
Construction time (years)	2	2	2	2	2						
Financial data											
Specific investment (M€ /MW Methanol)	4.51	4.51	3.01	2.26	1.50	50%	100%	80%	120%	F	1, 3, 5, 6
- equipment (%)	75	75	75	75	75						
-installation (%)	25	25	25	25	25						
Fixed O&M (M€ /MW Methanol/year)	0.053	0.053	0.053	0.053	0.053	90%	110%	90%	110%	E, F	1
Variable O&M (€ /MWh)	6.27	6.27	6.27	6.27	6.27	90%	110%	90%	110%	E, F	1
Start up (M€ /1,000 t Methanol)	0	0	0	0	0						
Technology specific data											
Specific energy content (GJ/ton methanol)	20.1	20.1	20.1	20.1	20.1						
Specific density (kg/l) or (ton/m3)	0.79	0.79	0.79	0.79	0.79						
Specific investment (M€ /1,000 t Methanol)	3.0	3.0	2.0	1.5	1.0	50%	100%	80%	120%	F	1, 3, 5, 6
- equipment (%)	75	75	75	75	75						
-installation (%)	25	25	25	25	25						
Fixed O&M (M€ /1,000 t Methanol)	0.035	0.035	0.035	0.035	0.035	90%	110%	90%	110%	E, F	1
Variable O&M (M€ /1,000 t Methanol)	0.035	0.035	0.035	0.035	0.035	90%	110%	90%	110%	E, F	1
Start up (M€ /1,000 t Methanol)	0	0	0		0						

Notes:

- A. The plant size range is based on the CRI plants and other analysis in the literature.
- A1. This value is the hourly rating and has been calculated as if the unit produces at capacity and was in operations 8,000 h/year.
- B. CO₂ availability is likely to determine the maximum plant size.
- C. Power use improvement depends on improved efficiency for electrolyzers.
- D. Methanol is the only output.
- E. Waste heat is of low quality.
- F. The methanol synthesis step does not lend itself to intermittent operation. The concept of intermittent power to methanol is not practical without intermediate storage for hydrogen that would allow the methanol plant to operate continuously. This would have a significant capital cost impact.
- G. There is a wide range of capital costs in the literature.
- H. M €/k tonne is million euro per 1,000 tonnes'

References

- [1] Next generation of methanol fuel cell vehicles sees the light of day. 2017. <http://serenergy.com/next-generation-of-methanol-fuel-cell-vehicles-sees-the-light-of-day/>
- [2] Stefansson, B. 2015. Power and CO₂ emissions to methanol. https://eu-ems.com/event_images/presentations/Benedikt%20Stefansson%20presentation.pdf
- [3] Stefansson, B. 2017. CO₂ to Renewable Methanol: experiences and perspectives for the steel industry. https://www.co2-cato.org/cato-download/4123/20170512_143353_20-11.00-Stefansson-public.pdf
- [4] MefCO₂ Project Brochure. 2017. http://www.mefco2.eu/pdf/MefCO2_Brochure_00.pdf
- [5] Atsonios K, et al., Investigation of technical and economic aspects for methanol production through CO₂ hydrogenation, International Journal of Hydrogen Energy (2016), <http://dx.doi.org/10.1016/j.ijhydene.2015.12.074>
- [6] Methanol Institute. <http://www.methanol.org/the-methanol-industry/>
- [7] Hovsopian, R. 2017. Role of Electrolyzers in Grid Services. US DOE. https://energy.gov/sites/prod/files/2017/06/f34/fcto_may_2017_h2_scale_wkshp_hovsopian.pdf
- [8] Manuel Götz, Jonathan Lefebvre, Friedemann Mörs, Amy McDaniel Koch, Frank Graf, Siegfried Bajohr, Rainer Reimert, Thomas Kolb, Renewable Power-to-Gas: A technological and economic review, In Renewable Energy, Volume 85, 2016, Pages 1371-1390, ISSN 0960-1481, <https://doi.org/10.1016/j.renene.2015.07.066>
- [9] Danish Technology Institute. 2011. GreenSynFuels. EUDP project journal number: 64010-0011. http://serenergy.com/wp-content/uploads/2015/11/GreenSynFuels_report_final.pdf
- [10] Haldor Topsøe. 2017. Gasoline synthesis (TIGAS). <https://www.topsoe.com/processes/gasoline-synthesis/gasoline-synthesis-tigas>
- [11] M. Pérez-Fortes and E. Tzimas; Techno-economic and environmental evaluation of carbon dioxide utilisation for fuel production. Synthesis of methanol and formic acid; EUR 27629 EN; <https://dx.doi.org/10.2790/981669>

[12] enea Consulting. 2016. The Potential of Power to Gas. Technology review and economic potential assessment. <http://www.enea-consulting.com/wp-content/uploads/2016/01/ENEA-Consulting-The-potential-of-power-to-gas.pdf>

[13] CRI. 2017. Commercial Scale Plants. <http://carbonrecycling.is/comercial-scale/>

99 SNG from Methanation of Biogas

Contact Information:

Danish Energy Agency: Jacob Hjerrild Zeuthen, jhz@ens.dk and Filip Gamborg, fgb@ens.dk

Author: Don O'Connor – (S&T)² Consultants Inc.

Publication date

August 2018

Amendments after publication date

Date	Ref.	Description
12 2018		Datasheet revised

Qualitative Description

Synthetic Natural Gas (SNG) is produced by the methanation of biogas. The main components in biogas are methane and CO₂. The content of CO₂ may vary between about 35-50 vol. % depending on the actual biogas production technology. The carbon dioxide in the biogas is reacted with hydrogen to produce additional methane. Alternatively, SNG can be produced via gasification and methanation of biomass which is described in Biomass Gasification - general introduction and the subsequent chapters.

This chapter does not consider the production of the hydrogen as there are multiple production options available.

Biogas, hydrogen production, and methanation are all commercial technologies but the combination of the three processes is a concept that is still at the research, development and deployment stage.

Brief Technology Description

The core unit in a methanation plant is the hydrogenation/methanation unit in which CO₂ is converted to methane by reacting with hydrogen. A catalyst is usually used for this process. The methanation reaction is exothermic and will generate large amount of heat. There is also some research and development work being undertaken on biological conversion routes [1]. This section is based on the chemical route.

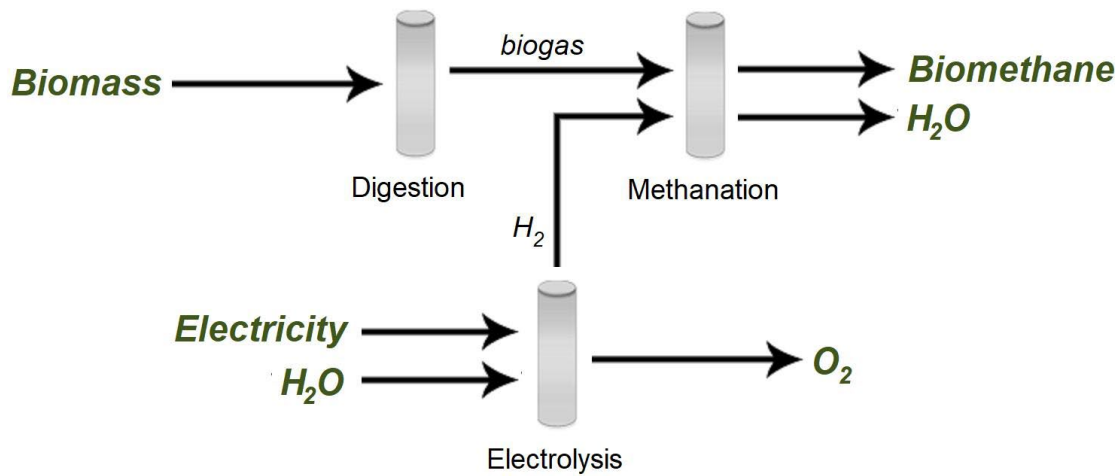

Figure 1 SNG Process

Input and Output

The systems require biogas, hydrogen and electricity to operate. They produce methane suitable for injection into the gas distribution grids, a small amount of water and some recoverable heat.

Energy Balance

The energy balance is presented as a Sankey diagram in the following figure. Note that this is based on hydrogen and the energy required to produce the hydrogen is not included. The data in the following table is based on “process concept 1” in the Swiss Federal Office of Energy report [2]. This is based on the biogas having 65% methane; gas with less methane will require more hydrogen and have a different energy balance.

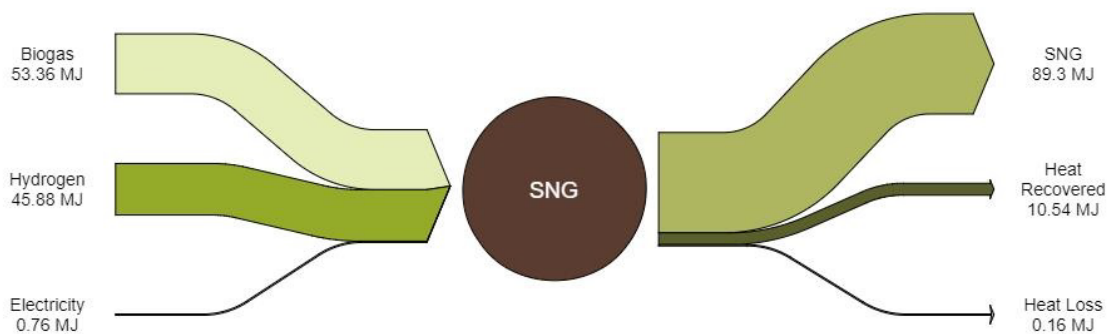

Figure 2 SNG Energy Balance

The methanation stage is relatively efficient with some high temperature (>100 C) heat recoverable from the process.

Typical Capacities

The capacities of the systems will likely be limited by the size of the biogas plants. Gotz et al [1] reports that in 2016 the largest demonstration plant was the Audi e-gas plant in Wertle, Germany with a hydrogen production capacity of 6 MW. The plant output was 325 NM³/hr (88,000 GJ SNG/year) (3 MW) [3]. Gotz et al undertook their techno-economic analysis on a plant that produced 1000 NM³/hr (270,000 GJ/year) (9 MW).

The concept could also be applied to other sources of carbon dioxide such as biomass gasification or industrial processes that produce high quality CO₂ such as ethanol production, some natural gas processing plants and processes such as ethylene oxide production [1]. Larger plants may be possible with these systems.

Regulation Ability

Without storage capacity of the biogas and the hydrogen the overall system will have very limited regulation capacity, as both inputs are required for the methanation stage.

The methanation process itself operates at elevated temperatures and load changes can induce unwanted temperature changes in the catalyst beds. Steady state operation will provide the optimum performance.

Space Requirements

The COSYMA (Container Based System for Methanation) pilot plant in Switzerland put the entire methanation process, including compressor and gas cleaning, is integrated into a standard 20 feet shipping container [2]. This was a small system but the space requirements will be less than the space requirements of the biogas facility.

Advantages/Disadvantages

The SNG concept can be considered another variation of the power to energy concept, although any source of hydrogen could be utilized in the process the most likely embodiment of the concept will produce the hydrogen from electricity. The process would essentially double the quantity of low carbon natural gas that can be produced from biogas plants and there is a ready market for the gas in the natural gas distribution systems.

The size of the plants will be limited by the capacity of biogas plants, which tend to be relatively small. Economies of scale that could reduce the production costs may be difficult to obtain. The potential to standardize and produce a number of systems that have an integrated electrolyzer and methanation unit may provide some help in reducing system costs.

Larger systems based on other sources of carbon dioxide may have more favourable economics and the potential to produce greater quantities of SNG. The GoBiGas project in Göteborg Sweden was design to produce 72 GJ/hour (576,000 GJ/year) of SNG in the first phase and eventually 2.3 to 2.9 million GJ/year in a final phase [4].

Environment

The overall impact on the GHG emissions of the produced SNG will be dependent on how the hydrogen is produced, hydrogen from electrolysis produced with renewable electricity will produce SNG with low GHG

emissions. Some of the other potential systems which utilize CO₂ from renewable sources may also have good emission profiles but CO₂ from fossil systems will not produce renewable natural gas.

The environmental impact from the biogas production system and from the hydrogen production system will be larger than from the methanation process.

Research and Development Perspective

SNG production from power is a category 2 technology, a pioneer phase technology with limited applications to date. The technology has been proven to work through demonstration facilities or semi-commercial plants. However, due to the limited application, the price and performance is still attached with high uncertainty, since development and customization is still needed. The technology still has a significant development potential.

As noted the three sub-processes are all commercial processes although the commercial methanation processes are generally at a larger scale than would be required for biogas plants. What is required for commercialization is the system integrators who can integrate hydrogen production and methanation into a system that can be added to the biogas production unit.

Examples of Market Standard Technology

Haldor Topsøe offers methanation technology, their TREMP™ process. The applications of the technology have been in larger fossil based industries.

The applications of the technology to smaller biogas facilities has been at the demonstration plant level, so no market standard technology has developed yet. There are at least three groups that are promoting their technology demonstrations.

The Paul Scherrer Institute in Switzerland along with their partners energie 360 and erdgas biogas have the Biosweet project that has an operating system at Zurich Biogas [2]. They have published results of their system analyses and demonstration plant performance.

The Vienna University of Technology [5] is offering a system with a single stage methanation step and membrane cleanup of the gas. They claim low capital and operating costs.

HZI Etogas develops and builds Power-to-Gas Plants. They built the Audi e-gas plant in Wertle, Germany in 2013. They claim to offer a modular structure that is suited for outdoor use. The plant consists of the following operating modules:

- power electronics with rectifiers (connection to medium voltage level)
- water treatment system
- hydrogen production (alkaline pressurized electrolysis)
- CO₂ feed gas treatment
- methanation reactor
- cooling system
- ancillary systems

The parent company is

Hitachi Zosen Inova.

Hardturmstrasse 127, 8005 Zurich, Switzerland.

They have recently received an order for a pilot facility in Japan that will take fossil CO₂ emissions from a coal fired power plant and combine them with hydrogen to produce SNG which will then be fed into an existing gas grid [6]. HZI will supply the electrolyzer and the methanation unit.

Predication of Performance and Cost

Each of the three processes involved in the concept is a commercial process at some scale. What is not well developed is the integration of the three processes and the demonstration of the methanation at a suitable scale. With very limited commercial deployment of the concept the predictions of performance and costs is developed from published reports and peer reviewed papers.

Uncertainty

Given the lack of commercial development and the potential for variations in the methanation process configuration there is a relatively high level of uncertainty with respect to the performance and cost.

Additional Remarks

The Audi e-gas plant in Wertle Germany is shown in the following photo.



Figure 3 SNG Methanation Plant

As with the discussion of power to methanol there are multiple options for hydrogen production for SNG systems. Haldor Topsøe designed and constructed a pilot plant that became operational April 2016 [7]. The

design capacity is 10 Nm³/h of upgraded biogas. This capacity requires approx. 50 kW solid oxide electrolyzer cell, which is provided by two Fuel Cores, each consisting of 4 SOEC stacks. Haldor Topsøe A/S also designed the biogas cleaning unit and the methanation plant which is located at the Agricultural Research Centre of Aarhus University at Foulum, Jutland.

Chemical reactions at temperature and pressure can be easily upset if there are rapid changes in the temperature. However, this system has proven to be capable of withstanding power loss without having a significant negative impact on the methanation catalyst. The high efficiency of the SOEC hydrogen production system should lead to a better energy balance than shown in Figure 1 in chapter

98 Methanol from Power. The facility is shown below.



Figure 4 Haldor Topsøe SNG Pilot Plant

Quantitative Description

The theoretical chemical reaction that occurs with methanation of biogas is shown below.

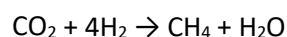

The reaction is exothermic (releases heat) and the reactors are operated at temperatures below 200°C (at 1 bar) or 300°C (20 bar) to reach conversion rates of greater than 98%.

The catalytic methanation reaction has been known since 1902. The technology has been developed for large scale coal to gas plants. The application of the technology may require some different concepts for the smaller scale and potentially intermittent or dynamic operation.

Typical Plant Size

It is the biogas plant that will determine the typical plant size and the hydrogen production and the methanation stages can be easily scaled to match the biogas output. Centralized Danish biogas plants range in size from about 70,000 to 700,000 GJ/year [8]. The trend is towards larger plants, driven by cost reductions related to economy-of-scale effects for the biogas plant and in particular the upgrading facilities.

Biogas SNG systems have approximately double the gas output of the biogas or 140,000 to 1.4 million GJ per year. This range is from 2 to 20 times the size of the operating Audi e-gas plant in Germany.

Input and Output

The inputs and outputs for a small system are shown in the following table [2]. The inputs to the system are biogas, hydrogen, and a small amount of power. The system output is SNG with approximately 98% methane. There are a number of possible process configurations involving the number of reactor stages, the operating pressures, and gas upgrading schemes.

Parameter	Input	Output
Biogas, 65% CH ₄	4,777 MJ	
Hydrogen	4,108 MJ	
Electricity	19 kwh	
SNG		8,000 MJ

Table 1 SNG Inputs and Outputs

Forced and Planned Outage

Ten to 15 days per year of downtime should be expected for the system for routine maintenance and changing catalysts.

Technical Lifetime

The technical lifetime of the systems should be greater than 25 years.

Construction Time

The construction time should be less than one year given the relatively small size and the ability modularize the hydrogen production and methanation stages of the process.

Financial Data

The most recent and comprehensive analysis of capital and operating costs for Bio SDMG systems is the work of Gotz [1].

Investment Costs

Gotz surveyed the literature and reported a wide range in the capital costs for methanation from a low of 36,000 €/GJ/hr SNG to 415,000 €/GJ/hr SNG. A small plant producing 70,000 GJ/year could have capital costs

of 3.36 million € to a high of 29 million € (€48/GJ to €414/GJ). Gotz concluded that the costs at the low end of the range were the most realistic as they were recently (2014) developed by an engineering company.

The capital costs of the methanation process were less than 5% of the capital costs of the electrolyzer, compressor and hydrogen storage requirements.

Operating and Maintenance Costs

Operating costs are dominated by the cost of hydrogen, which is excluded in this analysis. There is some electricity that is required for the operation of the methanation process but it is small compared to the hydrogen costs. Little information in the literature was identified for operating and maintenance costs. The fixed O&M costs are assumed to be 4% of the capital and the variable portion as 4% of the capital costs.

Start-up Costs

The start-up costs are expected to be low in a well-designed system. Some capital investment on intermediate storage of hydrogen and/or biogas will help to minimize the need for gas venting or flaring during start-up.

Technology Specific Data

The composition of the SNG will depend on the methanation design and the approach used for gas clean-up. The data from the Swiss project for the gas composition before the final clean-up are shown in the following figure.

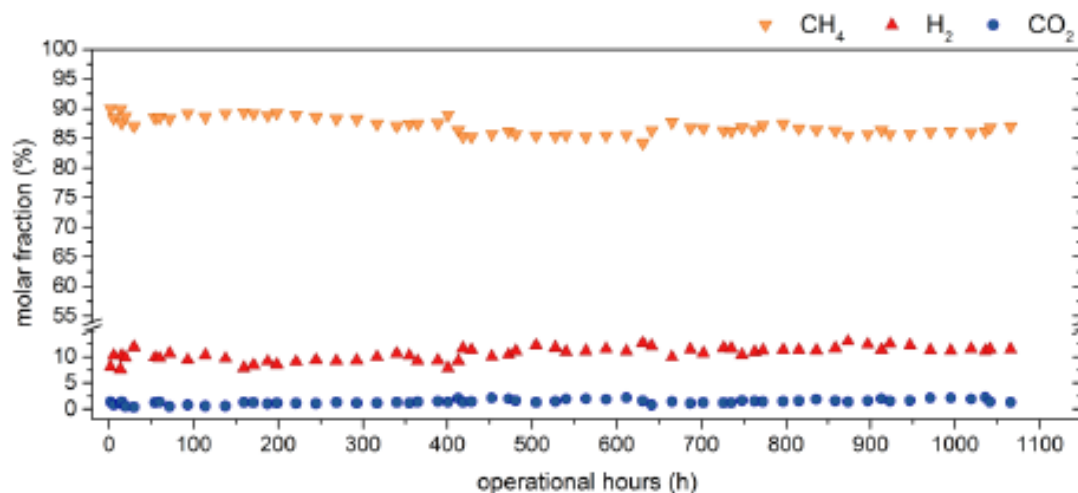

Figure 5 Gas Composition Prior to Final Clean-up

With some gas clean-up methane levels of greater than 95% can be achieved. Unlike the composition of fossil natural gas there is little to no C2 to C4 components present. The heating value of the gas may be lower than the typical fossil natural gas as a result, however as it is expected that the gas will be injected into the grid and co-mingled with fossil natural gas at a low concentration, there will be no impact on the final users.

Data sheet

The information on the SNG production process is summarized in the following table.

Technology	SNG from Biogas										Note	Ref
	2015	2020	2030	2040	2050	Uncertainty (2020)		Uncertainty (2050)				
						Lower	Upper	Lower	Upper			
Energy/technical data												
Typical total plant size 1,000 GJ SNG/year	70	100	250	500	700	75%	125%	75%	125%	A, B	1, 7	
Typical total plant size, MW	2.3	3.3	8.3	16.5	23.1	75%	125%	75%	125%	A, A1, B	1, 7	
Inputs												
Biogas Consumption, MWh/MWh Total Input	0.53	0.53	0.53	0.53	0.53	80%	120%	80%	120%	C, I	2	
Hydrogen Consumption, MWh/MWh Total Input	0.46	0.46	0.46	0.46	0.46	80%	120%	80%	120%	C, E	2	
Electricity Consumption, MWh/MWh Total Input	0.01	0.01	0.01	0.01	0.01	50%	150%	50%	150%	D	2	
Outputs												
SNG Output, MWh/MWh Total Input	0.89	0.89	0.89	0.89	0.89	90%	110%	95%	105%	G	2	
District Heating Output, MWh/MWh Total input	0.10	0.10	0.10	0.10	0.10	50%	150%	50%	150%	G	2	
Forced outage (%)	4	4	0	0	0					F		
Planned outage (weeks per year)	2	2	2	2	2							
Technical lifetime (years)	25	25	25	25	25							
Construction time (years)	1	1	1	1	1							
Financial data												
Specific investment (M€ /MW SNG)	1.09	0.91	0.76	0.60	0.45	50%	150%	50%	150%	H	1	
- equipment (%)	75	75	75	75	75							
-installation (%)	25	25	25	25	25							
Fixed O&M (M€ /MW/year SNG)	0.044	0.036	0.030	0.024	0.018	90%	110%	90%	110%		1	
Variable O&M (€ /MWh SNG)	5.18	4.32	3.60	2.88	2.16	90%	110%	90%	110%		1	
Start up (€ /GJ SNG)	0	0	0	0	0							
Technology specific data												
Specific energy content (GJ/ton) SNG	50.7	50.7	50.7	50.7	50.7							
Specific investment (M€ / 1000 GJ SNG)	0.036	0.03	0.025	0.02	0.015	50%	150%	50%	150%	H	1	
- equipment (%)	75	75	75	75	75							
-installation (%)	25	25	25	25	25							
Fixed O&M (€ /GJ SNG)	0.14	0.12	0.10	0.08	0.06	90%	110%	90%	110%		1	
Variable O&M (€ /GJ SNG)	0.14	0.12	0.10	0.08	0.06	90%	110%	90%	110%		1	
Start up (€ /GJ SNG)	0	0	0	0	0							

Notes:

- A. The plant size range is likely limited by the biogas availability.
- B. A1. This value is the hourly rating and has been calculated as if the unit produces at capacity and was in operations 8,000 h/year.
- C. Plant size progression is based on moving from small biogas system to large systems as the technology is proven.
- D. There are variations in the process that will have some impact on the overall efficiency. It is not yet clear what might become the industry standard.
- E. This is the power for the system excluding the electrolyzer.
- F. The methanation step does not lend itself to intermittent operation. The concept of intermittent power to SNG is not practical without intermediate storage for hydrogen that would allow the methanation plant to operate continuously. This would have a significant capital cost impact.
- G. Some recoverable waste heat is available from the process.
- H. There is a significant range in the capital cost estimates.
- I. Assumes that the biogas is 65% methane.

References

- [1] Manuel Götz, Jonathan Lefebvre, Friedemann Mörs, Amy McDaniel Koch, Frank Graf, Siegfried Bajohr, Rainer Reimert, Thomas Kolb, Renewable Power-to-Gas: A technological and economic review, In Renewable Energy, Volume 85, 2016, Pages 1371-1390, ISSN 0960-1481, <https://doi.org/10.1016/j.renene.2015.07.066>
- [2] Swiss Federal Office of Energy SFOE. 2017. Direct Methanation of Biogas. <https://www.aramis.admin.ch/Default.aspx?DocumentID=45656&Load=true>
- [3] gwf gas + energy. 2014. Das e-gas-Projekt am Biogasanlagen-standort in Werlte. https://www.diverlag.de/media/content/gwf-GE/gwf_Gas_5_14/gwf-GE_05_2014_FB_Kurt.pdf?xaf26a=7841c984ef837209544e
- [4] Rauch, R., Hrbek, J. and Hofbauer, H. 2014. Biomass gasification for synthesis gas production and applications of the syngas. WIREs Energy Environ, 3: 343–362. <https://doi.org/10.1002/wene.97>
- [5] Combination of Power-to-Gas with Biogas Plant. Vienna University of Technology. https://www.tuwien.ac.at/fileadmin/t/tuwien/fotos/pa/download/2015/HM2015/Flyer_Power_to_Bio--Gas_EN.pdf
- [6] Hitachi Zosen Corporation and Hitachi Zosen Inova to Build First Joint Power-To-Gas Plant. Dec 2017. <http://www.hz-inova.com/cms/en/home?p=6276>
- [7] Hansen, J., Holstebro, M., Jensen, M., Rass-Hansen, J., Heiredal-Clausen, T. 2016. SOEC Enabled Biogas Upgrading. 12th European SOFC & SOE Forum.
- [8] Udvikling og effektivisering af biogasproduktionen I Danmark – Delrapport 1 og 2, Danish Energy Agency Biogas Taskforce 2015.

100 Hydrothermal Liquefaction

Contact Information:

Danish Energy Agency: Jacob Hjerrild Zeuthen, jhz@ens.dk and Filip Gamborg, fgb@ens.dk

Author: Don O'Connor – (S&T)² Consultants Inc.

Publication date

August 2018

Amendments after publication date

Date	Ref.	Description
12 2018		Datasheet revised

Qualitative Description

Hydrothermal liquefaction of biomass is the thermochemical conversion of biomass into liquid fuels by processing in a hot, pressurized water environment for sufficient time to break down the solid biomass structure to mainly liquid components. Typical hydrothermal processing conditions are 250–420°C of temperature and operating pressures from 40 to 350 bar of pressure.

Alkali catalysts are often used to facilitate the degradation of macromolecules by hydrolysis, decarboxylation, and depolymerisation type of reactions, as well as inhibit formation of tar, char, and coke.

The process can handle most types of biomass and unlike some other thermochemical process it does not require dry biomass.

Brief Technology Description

A biomass slurry is fed into reactors at high pressure and high temperature. The slurry contains water, biomass and the alkali catalysts. The reactors provide sufficient residence time for the solid biomass to breakdown. After leaving the reactor the product stream is degassed and the liquid is separated into an aqueous phase and an oil phase. The aqueous phase is recirculated through the reactors and oil is available for market or further processing. The gas is used internally in the process to provide the thermal energy. The basic process flow is shown in the following figure.

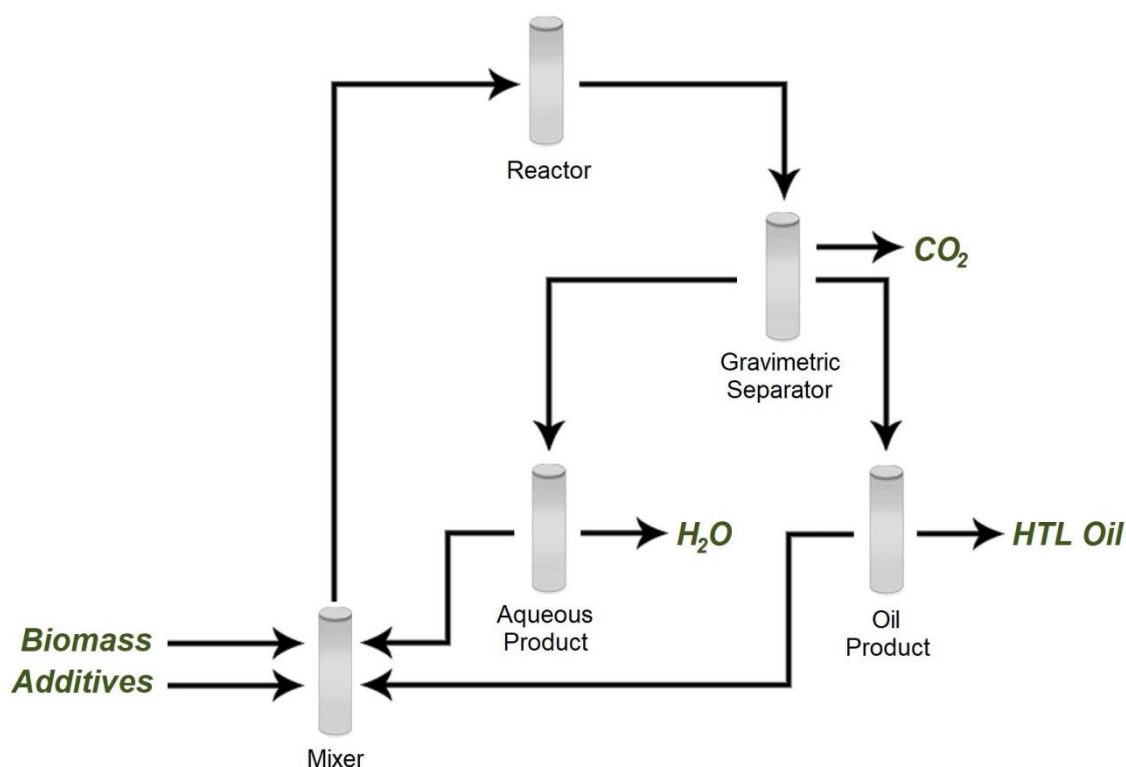

Figure 1 Hydrothermal Liquefaction Process Flow

Input

The process inputs are biomass, water, and an alkali catalyst. Some electricity is required to operate the process.

Output

The primary output from the system is the bio-oil and water that is recycled through the process. There is some gas produced in the reactors but this is consumed in the process to provide the process heat to maintain the reactor operating temperature.

Energy Balance

The energy balance of the process is shown in the following figure [4]. This energy balance is based on laboratory scale operations and could change with feedstock and operating conditions. A similar energy balance but without the electrical input was reported by Jensen [5].

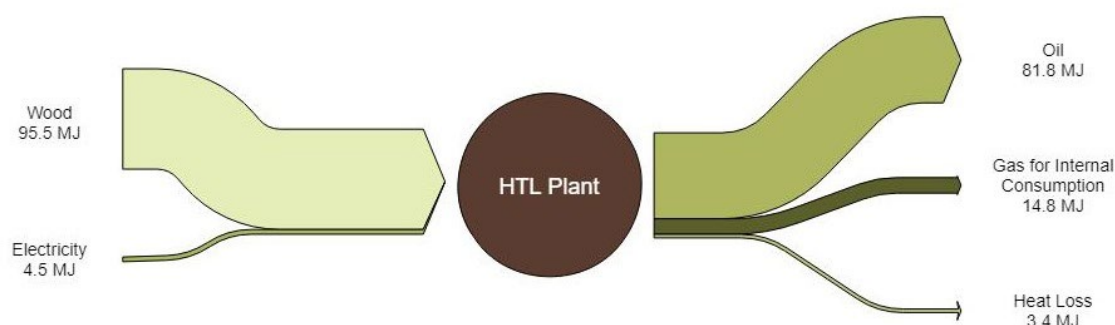

Figure 2 Hydrothermal Liquefaction Energy Balance

Typical Capacities

Steeper Energy, one of the companies developing the technology is proposing that its first commercial plants will produce 2,000 bbls or oil per day (140 MW) and consume 240,000 odt (oven dry tonne) of feedstock per year [6].

Zhu [7] undertook a techno-economic analysis of an HTL plant and upgrader that processed 2,000 odt per day and produced 3,780 to 4,900 bbls of oil per day. The low end of the production range represents the state of the art according to Zhu and the high end of the range, the ultimate design goal.

Regulation Ability

There is little published on the performance of continuously operated plants. Given the high pressure and temperatures required in the reactors and the required reactor residence time it is likely that the performance will be altered when the process is operated at rates below the design capacity.

Space Requirements

The space requirements are likely to be dominated by the area required for feedstock storage. None of the techno economic analyses found in the literature report the area required for the plants. There have been no large scale, similar technology plants built. The best estimate is that the area required would be similar to pulp mills that have the same feedstock inputs.

Advantages/Disadvantages

The primary attractiveness of the technology is that biomass can be converted into a liquid fuel. The HTL process produces a liquid with a low oxygen content compared to pyrolysis processes and may be suitable for use as a fuel that can substitute for heavy fuel oil in applications such as the marine sector. The low oxygen content will also make the fuel easier to hydrotreat to remove the oxygen and upgrade the fuel so that it is suitable for more demanding applications such as the use in transport diesel applications. The product could

also be used as a bio crude oil for use in existing petroleum refineries to produce bio-gasoline and diesel blending components that are available after fractionation.

Environment

The GHG emission performance of the product is expected to be very good due to the limited fossil fuel inputs into the system and the high oil yield. The high oil yield is also attractive where biomass availability is limited. The low oxygen content of the product will also mean that if it is upgraded through hydrotreating, the hydrogen requirements will be modest and the GHG emission profile will still be good.

Research and Development Perspective

Hydrothermal liquefaction of biomass to produce a bio-oil is a category 1 technology, a technology in the research, development and deployment stage. There is significant uncertainty with respect to the performance and costs of the technology.

There is potential to improve yields and reduce costs as more experience with the technology is gained from a demonstration facility and then the technology is scaled to commercial plants.

Examples of Market Standard Technology

Since this is a Category 1 technology there are no market standard technologies. One of the leading development companies with this technology is the Danish-Canadian company Steeper Energy. They have recently announced plans [1] for an industrial scale demonstration plant at a former pulp mill located in Tofte, Norway with their partner Silva Green Fuel, a Norwegian-Swedish joint venture.

Steeper Energy

Sandbjergvej 11
DK 2970 Hørsholm
Denmark
<http://steeperenergy.com/>

The other major technology supplier is the Australian company, Licella. They have formed a joint venture with the Canadian pulp and paper company Canfor and announced plans to build a 400,000 bbl/day facility in Prince George, BC, Canada [8].

Licella Pty Ltd

Level 7, 140 Arthur Street
North Sydney NSW 2060 Australia
<http://www.licella.com.au/contact/>

Predication of Performance and Cost

Given the early stage of development predictions of performance and cost are uncertain. The announcement of an industrial scale demonstration facility is a significant step in the development of the technology.

There is some discussion in the literature [7] of the current state of the art with respect to performance, capital costs and operating costs. These estimates have been developed by independent third parties and not by process developers.

Uncertainty

There is significant uncertainty with respect to performance and economics due to the stage of the development of the technology.

Additional Remarks

There is significant interest in this pathway from petroleum refiners. Due to the low oxygen content of the product there is a potential for the product to be co-processed in existing refineries with minimal modifications.

HTL oil is very viscous which will limit the potential applications of the oil to a replacement for other heavy viscous oil. The physical properties of HTL can be improved by hydrotreating the oil.

Jensen et al [9] have reported that about 2% wt. hydrogen is consumed when the oil is hydrotreated. Hydrotreating yields were about 80% on a mass basis, and over 90% on an energy basis. Hydrotreating also produced 9% water and 5-6% gas. The properties of the HTL and the hydrotreated HTL are shown in the following table. The hydrotreated HTL properties will vary with the severity of the hydrotreating.

	HTL	Hydrotreated HTL
Density (kg/m ³)	1103	989
Viscosity at 20°C (cP)	80,432	297
HHV (MJ/kg)	37.2	42.1
Carbon (wt. %)	80.6	88.1
Hydrogen (wt. %)	9.1	11.9
Oxygen (wt. %)	10.1	0.0
Nitrogen (ppm)	1500	1175
Sulphur (ppm)	309	389
TAN (mg/g)	55.7	0.0

Table 1 Hydrotreated HTL Properties

Quantitative Description

The reaction chemistry of hydrothermal liquefaction is complex, and many different chemical reactions may proceed depending of the specific operating conditions. Jensen et al [2] have proposed a number of the major chemical reactions involved in the process and these are shown in the following figure.

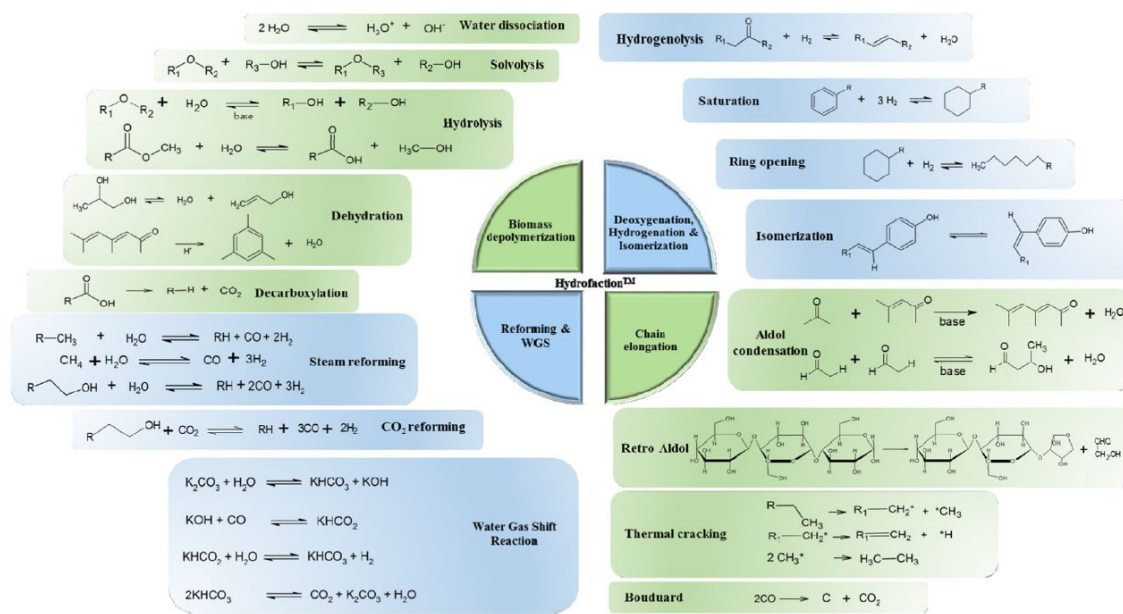

Figure 3 Major Chemical Reactions in the Steeper Energy Process

Typical Plant Size

The technology has not yet moved beyond the pilot plant stage. Steeper and Licella are planning commercial plants in the range of 1,000 to 2,000 bbls per day. Techno-economic assessments [7] have considered plants of 5,000 bbls/day as long term design objective. These different plant sizes are shown in the following table with different approximate equivalent metrics.

Volume Based, bbl/day	Input Mass Based, tpy	Energy Output Based, GJ/day
1,000	120,000	6,100
2,000	240,000	12,200
5,000	600,000	30,500

Table 2 Typical Plant Sized

Input and Output

The input and output for a 1,000 bbl/day plant has been extrapolated from Steeper published information [4] and summarized in the following table. In addition to the parameters shown in the table there would be 420 GJ of produced gas that is utilized in the process.

	Input	Output
Wood, tonnes/day	350	
Power, kWh	93,325	
Bio-oil, bbls/day		1,000 Bbls

Table 3 Typical Input and Output

Forced and Planned Outage

Harris Group prepared a report on HTL reactor design for the National Renewable Energy Laboratory (NREL) and used a 90% on stream design factor. That allows 36 days per year for system maintenance.

The combination of a solid feedstock and the high pressures involved have been problematic for systems like pressurized biomass gasification systems. Harris reported that primary challenges associated with the reactor section design were (1) maximizing heat integration, (2) managing the potential for poor heat transfer from the reactor effluent to the reactor feed due to the potential for high viscosities in the feed streams, and (3) minimizing cost associated with the reactor system itself, given the very high required pressures. It is possible that the first large scale demonstration plants will experience some forced outages as these challenges are addressed.

Technical Lifetime

Plants of this type would normally be designed for at least a 20 year lifetime.

Construction Time

Construction periods of 2 years are likely due in part to the fabrication time of the specialty high pressure reactors involved in the process.

Financial Data

Several sources of detailed information [7] [10] [11] [12] on capital costs and operating costs are in the public domain. These have mostly been generated by independent third parties and not by the leading process developers. However, Pedersen et al [12] are involved with Steeper Energy so the information from this paper has been used in the data sheet. The information from of the reports is discussed below.

Investment Costs

Zhu et al [7] and Pedersen et al [12] provided information for both the production of HTL and for upgrading the HTL to a pure hydrocarbon. The capital costs are compared in the following table. The Harris Group [10] investigated five different designs with widely varying capital costs due to trying to address the design challenges identified above.

Parameters	Zhu	Harris	Pedersen
Base Year for Costs	2007	2011	2016
Feedstock, tpd	2000	2000	500
Total Capital Investment	\$512 Million	\$222 to \$1,646 million	\$225
Best case		\$364 million	

Table 4 Capital Cost Comparison

The cost estimate by Zhu et al was prepared using Aspen Process Economic Analyzer includes an allowance for potential missing equipment in the design. The estimate by Harris Group is an engineering estimate based on vendor quotes for the equipment. Both estimate approaches use factors for the installation costs and indirect construction costs.

Using the estimate by Pedersen et al and an output of 1150 bbl/day the capital costs are \$3.40/annual litre (€3.5/annual litre for a plant in Europe).

Operating and Maintenance Costs

The operating and maintenance costs were estimated in the studies. The results are compared in the following table. The report by Zhu et al does not separate the operating costs for the upgrading from the HTL production.

Parameters	Zhu	Harris
Feedstock	\$46 million	Not reported
Waste disposal	\$25 million	Not reported
Utilities	\$8 million	\$22 million
Fixed costs	\$24 million	\$10 million

Table 5 Operating and Maintenance Costs

The operating and maintenance costs from the two reports have significantly different profiles. Pedersen provided a more detailed breakdown of the variable operating costs. The data was presented per litre of gasoline equivalent (LGE). Here, the data is converted to a per-litre of HTL basis by assuming that 1 LGE is equal to 0.90 litres of HTL. The information is shown in the following table.

Parameter	US\$ per Litre HTL
Feedstock	0.13
Hydrogen	0.11
Thermal energy	0.24
Power	0.05
Wood Grinding	0.058
Water disposal	0.014
Fixed O&M	0.10

Table 6 Operating and Maintenance Costs

The variable O&M costs less feedstock, power and thermal energy is 0.18 US\$/litre (0.15 €/litre) and the fixed O&M is 0.10 US\$/litre (0.08 €/litre).

Start-up Costs

The start-up costs are included in the operating cost estimates.

Technology Specific Data

The properties of the Hydrofaction™ oil produced by the Steeper Energy process are shown in the following table [2] and compared to typical values for heavy fuel oil [3]. The bio-oil has some oxygen which reduces the energy content and increases the density but the properties are broadly similar. The bio-oil viscosity is very sensitive to the temperature and is more viscous than the petroleum HFO at the same temperature.

Parameter	Hydrofaction™ Oil	Heavy Fuel Oil
Energy Content, MJ/kg (LHV)	36.7	39
Water Content, wt. %	0.8	0.1
Density, kg/m ³	1.05	0.98
Oxygen Content, wt. %	9.8	0
Pour Point, C	24	15
Flash Point, C	29	100
Kinematic viscosity at 40 °C, mm ² /s	17,360	
Kinematic viscosity at 50 °C, mm ² /s		200-600
Kinematic viscosity at 60 °C, mm ² /s	1,545	

Table 7 HTL Bio-Oil Properties

Data sheet

The information on HTL production is summarized in the following table. Since there are no operating plants in 2015, the data is presented for the years 2020 to 2050.

Technology	HTL Bio Oil										
	2015	2020	2030	2040	2050	Uncertainty (2020)		Uncertainty (2050)		Note	Ref
						Lower	Upper	Lower	Upper		
Energy/technical data											
Typical total plant size 1,000 t Bio Oil/year	n.a.	120	180	250	300	50%	125%	75%	125%	A, B	1, 6
Typical total plant size. MW	n.a.	145	220	300	360	50%	125%	75%	125%	A, A1, B	1, 6
Inputs											
Feedstock Consumption, MWh/MWh Total Input	n.a.	0.95	0.95	0.95	0.95	90%	150%	90%	125%	E	4
Electricity Consumption, MWh/MWh Total Input	n.a.	0.05	0.05	0.05	0.05	75%	125%	75%	125%	E	4
Outputs											
Bio Oil Output, MWh/MWh Total Input	n.a.	0.82	0.82	0.82	0.82	90%	110%	90%	110%	E	4
Co-products Output MWh/MWh Total Input	n.a.	0	0	0	0	90%	110%	90%	110%	E	4
Forced outage (%)	n.a.	4	0	0	0						
Planned outage (weeks per year)	4	4	4	4	4					C	8
Technical lifetime (years)	20+	20+	20+	20+	20+						
Construction time (years)	2	2	2	2	2						
Financial data											
Specific investment (M€ / MW Bio Oil)	n.a.	2.20	1.65	1.24	1.10	75%	125%	75%	125%	D, G	6, 8
- equipment (%)	n.a.	75	75	75	75						
-installation (%)	n.a.	25	25	25	25						
Fixed O&M (M€ / MW Bio Oil/year)	n.a.	0.063	0.063	0.063	0.063	75%	125%	75%	125%	F, G	6
Variable O&M (€ /MWh)	n.a.	14.013	14.013	14.013	14.013	75%	125%	75%	125%	F, G	6
Start up (€ /MW Bio Oil)	n.a.	0	0	0	0						
Technology specific data											
Specific energy content (GJ/ton) HTL	36.7	36.7	36.7	36.7	36.7						
Specific density (kg/l) or (ton/m3)	1.05	1.05	1.05	1.05	1.05						
Specific investment (M€ /1000 t Bio Oil)	n.a.	2.67	2.00	1.50	1.33	75%	125%	75%	125%	D, G	6, 8
- equipment (%)	n.a.	75	75	75	75						
-installation (%)	n.a.	25	25	25	25						
Fixed O&M (M€ /1,000 t Bio Oil)	n.a.	0.076	0.076	0.076	0.076	75%	125%	75%	125%	F, G	6
Variable O&M (M€ /1,000 t Bio Oil)	n.a.	0.143	0.143	0.143	0.143	75%	125%	75%	125%	F, G	6
Start up (M€ /1,000 t Bio Oil)	n.a.	0	0	0	0						

Notes:

- A. The plant size range is likely limited by the feedstock availability.
- A1. This value is the hourly rating and has been calculated as if the unit produces at capacity and was in operations 8,000 h/year.
- B. The plant size range is typical of the range found in the literature. It is highly uncertain given that there is no commercial demonstration plant in operation yet.
- C. This is twice the time normally found in process operations.

- D. Capital costs for nth plant are used for 2050 and earlier costs are estimates.
- E. These are based on extrapolated pilot plant results.
- F. Nth plant estimates
- G. M €/k tonne is million euro per 1,000 tonnes

References

- [1] Steeper Energy Announces Eur 50.6 M (Dkk 377 M) Advanced Biofuel Project With Norwegian-Swedish Joint Venture Silva Green Fuel In Licensing Deal. 2017. <http://steeperenergy.com/2017/12/15/steeper-energy-announces-eur-50-6-m-dkk-377-m-advanced-biofuel-project-with-norwegian-swedish-joint-venture-silva-green-fuel-in-licensing-deal/>
- [2] Jensen, C.U., Rodriguez Guerrero, J.K., Karatzos, S. et al. 2017. Fundamentals of Hydrofaction™: Renewable crude oil from woody biomass. *Biomass Conv. Bioref.* (2017) 7: 495. <https://doi.org/10.1007/s13399-017-0248-8>
- [3] Environment Canada. 1999. Bunker C Fuel Oil. www.etc-cte.ec.gc.ca/databases/oilproperties/pdf/web_bunker_c_fuel_oil.pdf
- [4] Fracking Biomass. *Biofuels Digest*. Feb 2, 2017. <http://www.biofuelsdigest.com/bdigest/2017/02/02/fracking-biomass-steeper-energy-and-the-pursuit-of-renewable-hydrocarbons/>
- [5] Jensen, C.U., Rodriguez Guerrero, J.K., Karatzos, S. et al. *Biomass Conv. Bioref.* (2017) 7: 495. <https://doi.org/10.1007/s13399-017-0248-8>
- [6] Toms, P. 2017. Hydrofaction™ Oil: A Solution for Decarbonizing Long-haul Transport. <https://www.bio.org/sites/default/files/0830AM-Perry%20Toms.pdf>
- [7] Zhu, Y., Bidy, M., Jones, S., Elliott, D., Schmidt, A. 2014. Techno-economic analysis of liquid fuel production from woody biomass via hydrothermal liquefaction (HTL) and upgrading, In *Applied Energy*, Volume 129, 2014, Pages 384-394, ISSN 0306-2619, <https://doi.org/10.1016/j.apenergy.2014.03.053>
- [8] Licella. 2016. Licella Canfor Joint Venture at the forefront of global bioenergy. <http://www.licella.com.au/news/licella-canfor-joint-venture-at-the-forefront-of-global-bioenergy/>
- [9] C.U. Jensen, J.K.R. Guerrero, S. Karatzos, G. Olofsson and S.B. Iversen, 10 - Hydrofaction™ of forestry residues to drop-in renewable transportation fuels, In *Direct Thermochemical Liquefaction for Energy Applications*, edited by Lasse Rosendahl,, Woodhead Publishing, 2018, Pages 319-345, ISBN 9780081010297, <https://doi.org/10.1016/B978-0-08-101029-7.00009-6>.
- [10] Harris Group. 2013. Production of Advanced Biofuels via Liquefaction Hydrothermal Liquefaction Reactor Design. NREL/SR-5100-60642. <http://www.ourenergypolicy.org/wp-content/uploads/2015/08/60462.pdf>
- [11] Magdeldin, M., Kohl, T., Järvinen, M. 2018. Techno-economic Assessment of Integrated Hydrothermal Liquefaction and Combined Heat and Power Production from Lignocellulose Residues, *J. sustain. dev. energy water environ. syst.*, 6(1), pp 89-113, 2018. <https://doi.org/10.13044/j.sdewes.d5.0177>
- [12] Pedersen, T. H., Hansen, N. H., Pérez, O. M., Cabezas, D. E. and Rosendahl, L. A. 2018. Renewable hydrocarbon fuels from hydrothermal liquefaction: A techno-economic analysis. *Biofuels, Bioprod. Bioref.*, 12: 213-223. doi:[10.1002/bbb.1831](https://doi.org/10.1002/bbb.1831)

101 Catalytic Hydropyrolysis

Contact Information:

Danish Energy Agency: Jacob Hjerrild Zeuthen, jhz@ens.dk and Filip Gamborg, fgb@ens.dk

Author: Don O'Connor – (S&T)² Consultants Inc.

Publication date

December 2018

Amendments after publication date

Date	Ref.	Description
02 2019		Financial data added for configuration 1

Qualitative Description

Catalytic hydropyrolysis (CHyP) of biomass is the thermochemical conversion of biomass into bio-oil or liquid fuels by processing with hydrogen and a catalyst to break down the solid biomass structure to liquid, gaseous and solid components. Typical catalytic hydropyrolysis processing conditions are 375-475 °C of temperature and operating pressures from 10 to 30 bar.

There are a number of possible configurations of the technology. In some proposed configurations the catalytic hydropyrolysis stage is followed by a further hydrotreating stage and drop-in liquid fuels in the gasoline and diesel range can be produced instead of bio-oil. Like the fast pyrolysis process, the feedstock must be appropriately sized and relatively dry (<10% moisture).

Brief Technology Description

Dry and sized biomass along with hydrogen is fed into a reactor at high pressure and high temperature. The reactor contains a catalyst and most proponents utilize a fluid bed reactor for rapid heat transfer. After leaving the hydropyrolysis reactor the char and catalyst are removed by a cyclonic separator and the gas goes to a hydroconversion reactor where more hydrogen is added. After that hydroconversion reactor the gaseous stream is condensed and the condensed liquid is phase separated into an aqueous phase and an oil phase. There is also an uncondensed gaseous phase. In some systems the liquid is further hydrotreated and distilled to produce gasoline and diesel fuel fractions. The aqueous phase and uncondensed gas can be steam reformed to produce the energy and hydrogen required by the process.

The basic process flow is shown in the following figure.

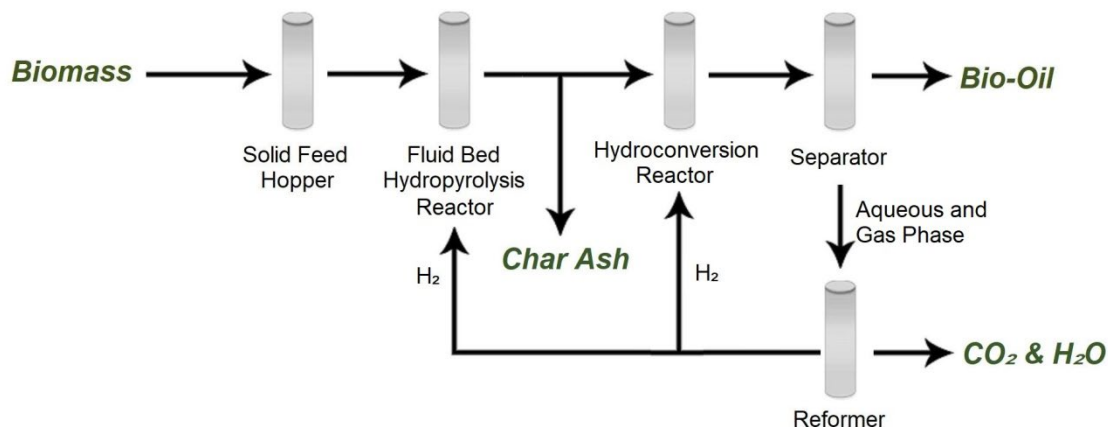

Figure 1: Catalytic Hydrolysis Process Flow

Input

The process inputs are biomass, hydrogen, and a catalyst. Some electricity is required to operate the process. In some configurations, including the one closest to commercialization, the hydrogen can be produced internally using the produced gas and char.

Output

The energy containing outputs from the system can be organic liquids (bio-oil), biochar, gas and heat. The gas could be a source of CO₂ for methanization for SNG production. There is also water produced by the system. Other configurations consume the gas and the char to produce the hydrogen.

The bio-oil produced in the first reactor will still have some oxygen in it, although at reduced levels compared to the fast pyrolysis process. It will have limited miscibility with petroleum products and will require further processing for many applications. Systems with the secondary hydrotreating can produce hydrocarbons in the gasoline and diesel fuel range.

Energy Balance

The energy balance for catalytic hydroprocessing is shown in the following figure [1]. This data is based on a laboratory study that investigated the impact of temperature and pressure on the distribution of products. The catalytic hydrolysis was undertaken in a fluid bed reactor with a cobalt molybdenum catalyst, followed by deep hydrodeoxygenation using a nickel molybdenum catalyst in the hydroconversion reactor.

Since this is based on an experimental system it is not fully optimized and the char, gas, and excess heat are shown as products.

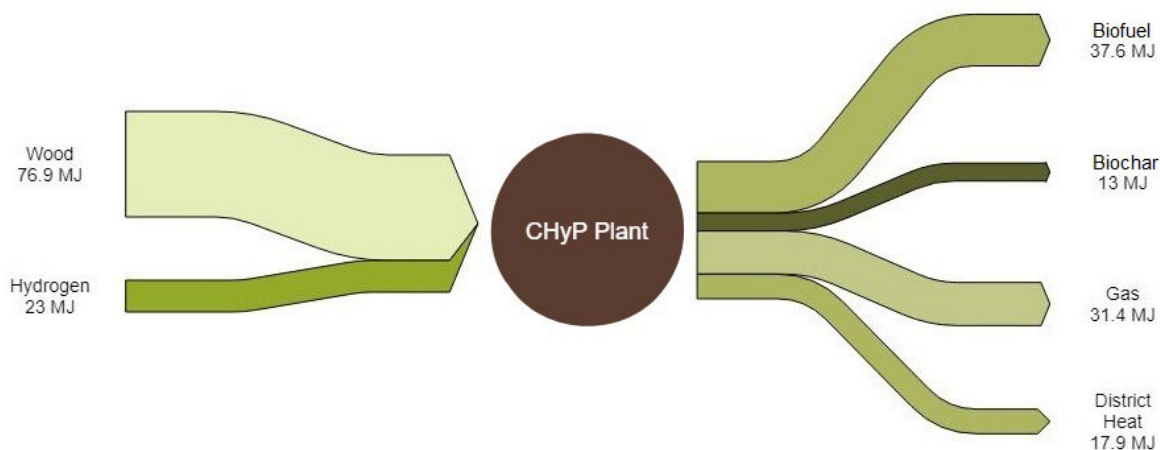

Figure 2: Catalytic Hydropyrolysis Energy Balance – Configuration 1

A second version of the energy balance of the process is shown in the following figure [2]. This energy balance is based on renewable gasoline and diesel produced by the integrated hydropyrolysis and hydroconversion (IH²) process at an existing petroleum refinery in the United States. This process has been optimized to produce liquid products and it utilizes all of the char and gas to supply the energy and hydrogen requirements for the process. It is this process which has received the most attention in the literature and has published techno-economic assessments. It is this process that the primary data sheet has been based on.

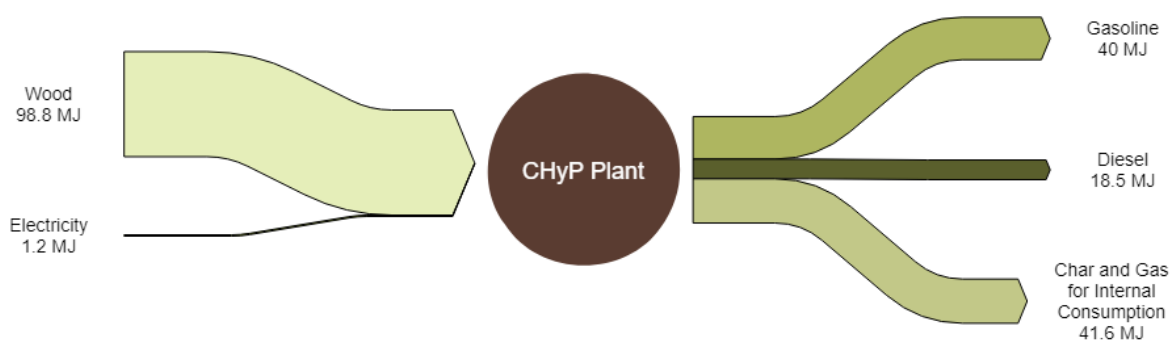

Figure 3: Catalytic Hydropyrolysis Energy Balance – Configuration 2

Alternative configurations may be possible, particularly where the char has higher value applications than just energy production, but then other energy inputs into the system would be required.

Typical Capacities

CRI Catalyst, the company developing the IH² technology has a demonstration facility in India which processes five metric tonnes of feedstock per day on a dry, ash-free basis [3].

They claim that they have provided 11 IH² Technology licenses through the end of 2017 for customers to conduct detailed site-specific feasibility studies (FEED). These facilities span the biomass feedstock spectrum, including wood, crop residues, municipal solid waste and co-located and integrated with a petroleum refinery with clients in North America, Europe and Asia. Most of these commercial facilities would be brownfield sites, integrating with existing operations. The FEED designs are for units between 500 and 1,500 tonnes biomass/day plants using paper & pulp, forestry and agricultural residue feedstock.

The latest license has been signed with Biozin AS, a wholly owned subsidiary of the Norwegian forest products company Bergene Holm AS. They have plans for five plants, each producing 120 million litres of fuel per year plus biochar [4]. The product will be further process to meet specifications at an oil refinery.

CRI also participated with the National Renewable Energy Laboratory (NREL) in a techno-economic study of 2,000 tonnes/day woody biomass feed and 230 million litre/year facility [5].

Regulation Ability

There is little published on the performance of continuously operated plants. Given the high pressure and temperatures required in the reactors and the required reactor residence time it is likely that the performance will be altered when the process is operated at rates below the design capacity.

Space Requirements

The space requirements are likely to be dominated by the area required for feedstock storage. The NREL techno economic analyses [5] found in the literature assumed 46 ha would be required for the 2000 tpd plant. There have been no large scale, similar technology plants built.

Advantages/Disadvantages

The primary attractiveness of the technology is that biomass can be converted into drop in liquid fuels if the second stage hydrotreating and distillation steps are included. There is also a relatively high energy and carbon efficiency compared to other cellulosic biomass conversion technologies.

Feeding solids into a high pressure reactor has been a problem for other biomass technologies and there is the potential for catalyst deactivation with the direct contact between the catalyst and the biomass in the first reactor.

Environment

The GHG emission performance of the product will depend on the process configuration. When the char and gases are used to produce the hydrogen most of the energy will be internally generated and the GHG

emission performance will be very good. When the hydrogen is supplied externally from fossil resources, the GHG emissions will be higher and the overall system GHG performance will be a function of how the allocation of the emissions to the char and the gaseous co-products are handled.

The fuel gas is biogenic and will contain a range of light hydrocarbons, carbon monoxide and dioxide and hydrogen. It is suitable for combustion and can replace natural gas or other fossil fuels.

Biochar could have a number of potential applications. It has been used as a soil amendment and it appears to stimulate plant growth and at the same time be relatively inert with a long life in the soil, making it a form of carbon sequestration. It may also be used to replace coal in power plants and in steel making.

Research and Development Perspective

Catalytic hydrolysis of biomass to produce either bio-oil or a drop-in fuel is a category 1 technology, a technology in the research, development and deployment stage. There is significant uncertainty with respect to the performance and costs of the technology.

There is potential to improve yields and reduce costs as more experience with the technology is gained from a demonstration facility and then the technology is scaled to commercial plants.

Examples of Market Standard Technology

Since this is a Category 1 technology there are no market standard technologies. One of the leading development companies with this technology is CRI Catalysts. CRI/Criterion Catalyst Company LTD (CRIUK), a global catalyst technology company wholly owned by Royal Dutch Shell.

CRI Catalyst

London England

<https://www.cricatalyst.com/cricatalyst/contact-us>

Prediction of Performance and Cost

Given the early stage of development predictions of performance and cost are uncertain. The NREL techno-economic analysis was done in 2013 [5] and the demonstration plant in India did not become operative until 2017.

Another techno-economic analysis was done on a mild catalytic pyrolysis process [6] but this was also published in 2014. This process employed catalytic pyrolysis followed by hydrotreating and was similar in concept to the Kior process, which was not a commercial success.

Uncertainty

There is significant uncertainty with respect to performance and economics due to the stage of the development of the technology.

Additional Remarks

There is interest in this pathway from petroleum refiners. Due to the low oxygen content of the stage 1 product, there is the potential for the product to be co-processed in existing refineries with minimal modifications. Mehta [7] reported some of the product properties after the first stage and the second hydrotreating stage. The nitrogen content in the table is from Marker [9] and is dependent on the feedstock (values for wood are shown). The amount of deoxygenation after the first stage is significant compare to other pyrolysis systems and hydrothermal liquefaction (HTL) processes.

	First Stage	Second Stage
Density (kg/m ³)	865	832
Carbon (wt. %)	85.7	88.0
Hydrogen (wt. %)	11.0	12.0
Oxygen (wt. %)	3.3	0.0
Sulphur (ppm)	273	9
Nitrogen (wt%)		<0.1
TAN (mg/g)	2.2	<0.001

Table 1: Catalytic Hydropyrolysis Oil Properties

The first stage product has specific gravity of 0.865 and a low sulphur content (0.03%). It is heavier than Brent or WTI crude oil, but it does have one tenth the sulphur content and 3.3% oxygen compared to less than 1% in the petroleum crude oils.

The biochar produced from wood was analyzed by Marker [9] and the results are shown in the following table.

Component	Weight %
Carbon	77.60
Hydrogen	4.46
Nitrogen	0.22
Sulfur	0.24
Oxygen	13.24
Ash	4.25
Moisture	0.73
Potassium	0.29
Sodium	0.04
Phosphorus	0.04
Heating value, MJ/kg	28.8

Table 2: Biochar Analysis

The gas composition varies with operating conditions [14] as shown below. The percentages are of the mass of products produced, oil, char, and gas.

Component	Range
CO plus CO ₂	8-14 wt %
C1 + C2 + C3 hydrocarbons	10-18 wt %

Table 3: Gas Composition

Quantitative Description

The IH² technology was originally developed with the Gas Technology Institute in the United States before Shell and CRI became involved. The early work was supported by the US Department of Energy and there are

a number of progress reports on the technology that are available detailing research between 2010 and 2017 [8] [9] [10].

Energy/Technical Data

Some quantitative information on the process is presented below.

Typical Plant Size

The technology has not yet moved beyond the pilot plant stage. IH² are planning on plant sizes between 500 and 1500 tonnes per day [3] [5].

Input Mass Based, tpd	Litres/year	Energy Output Based, GJ/day
500	58 Million	5,000
1,000	115 million	10,000
1,500	172 million	15,000

Table 4: Typical Plant Size

Input and Output

The input and output for a 1,000 tonne/day plant has been interpolated from the NREL published techno-economic report [5] and summarized in the following table. This plant produced its own power and hydrogen.

	Input	Output
Wood, tonnes/day	1,000	
Gasoline, litres		197,000
Diesel, litres		101,000

Table 5: Typical Input and Output – Techno-Economic Data

The inputs and outputs that were used for the LCA study in the same report have slightly different values when they are scaled to the same 1,000 tonne/day plant as shown in the following table. In this configuration the internal use of the char and the gas produced more hydrogen than the process required and the excess was exported to the adjacent oil refinery.

	Input	Output
Wood, tonnes/day	1,000	
Power, kWh/day	5,880	
Gasoline, litres		213,000
Diesel, litres		120,000
Export steam, 1000 kg/day		1,450
Excess hydrogen, kg/day		8,200

Table 6: Typical Input and Output – LCA Data

Forced and Planned Outage

The NREL techno-economic report was based on 350 operating days per year with 15 days available for planned maintenance. Since this is an immature technology a two week allotment (4%) is provided for forced allocations.

Technical Lifetime

Plants of this type would normally be designed for at least a 20 year lifetime. The NREL techno-economic study assumed a 30 year life.

Construction Time

Construction periods of 3 years were allowed for the NREL techno-economic study.

Financial Data

There is limited recent financial data available for the process. The NREL study has the most detail available.

Investment Costs

NREL's [5] capital cost estimate was based on a 2,000 tpd nth plant and was reported in 2007 US dollars. A more recent capital cost estimate was published by Meerman [15]. This was for a first of kind plant with some differences in scope to the NREL plant but Meerman also undertook some adjustments to provide a more direct comparison and found that the costs were within 15% of each other. The techno-economic analysis published by Thilakaratne et al [6] has a much lower liquid product yield so it is not considered in this analysis.

Parameters	Tan	Meerman FOAK	Meerman nth plant
Base Year for Costs	2007	2014	2016
Feedstock, tpd	2000	3425	2000
Total Capital Investment	\$211 Million	\$612 Million	\$199 million

Table 7: Capital Cost Comparison

Tan's cost did not include feedstock preparation costs (screening and grinding) which were imbedded in the feedstock delivery costs.

Operating and Maintenance Costs

The operating and maintenance costs were estimated in the Tan study. The system produced its own hydrogen and power was also produced on site. These factors keep the operating costs low.

The fixed costs were \$10.8 million per year and the variable costs (excluding feedstock) were \$4.5 million per year.

The fixed costs amount to \$0.047/litre (US \$) and the variable costs \$0.02/litre (US \$).

Start-up Costs

Tan estimated that three months would be required to start up the plant.

Technology Specific Data

There has been relatively little detailed technical information released in the last several years. Presentations from 2015 [12] indicate that the finished gasoline and diesel fuel don't quite meet the gasoline and diesel specifications and most of the issues are related to high aromatic contents. A 2018 presentation [13] indicates that the products do now meet the EN 228 standard for gasoline (35% aromatics max) and EN 590 for diesel except for the cetane number.

Data sheet

The information on catalytic hydroprocessing is summarized in the following table. Since there are no operating plants in 2015, the data is presented for the years 2020 to 2050. The data table is based on Configuration 2, since that is the closest to commercialization.

Catalytic Hydroprocessing Datasheet – Configuration 2:

Technology	Catalytic Hydroprocessing conf. 2										
	2015	2020	2030	2040	2050	Uncertainty (2020)		Uncertainty (2050)		Note	Ref
						Lower	Upper	Lower	Upper		
Energy/technical data											
Typical total plant size 1,000 t Bio Oil/year	n.a.	40	80	120	160	50%	125%	75%	125%	A, B	3, 4
Typical total plant size. MW	n.a.	57	114	171	228	50%	125%	75%	125%	A, A1, B	3, 4
Inputs											
Feedstock Consumption, MWh/MWh Total Input	n.a.	0.99	0.99	0.99	0.99	90%	150%	90%	125%	D	5
Electricity Consumption, MWh/MWh Total Input	n.a.	0.01	0.01	0.01	0.01	75%	125%	75%	125%	D	5
Outputs											
Gasoline fraction, MWh/MWh Total Input	n.a.	0.38	0.39	0.4	0.41	90%	110%	90%	110%	D, H	5
Diesel fraction, MWh/MWh Total Input	n.a.	0.17	0.18	0.18	0.19	90%	110%	90%	110%	D, H	5
Co-products Output MWh/MWh Total Input	n.a.	0	0	0	0	90%	110%	90%	110%	D	5
Operational data											
Forced outage (%)	n.a.	4	4	0	0						
Planned outage (weeks per year)	n.a.	2	3	4	5						5
Technical lifetime (years)	n.a.	20+	20+	20+	20+						
Construction time (years)	n.a.	2	2	2	2						5
Financial data											
Specific investment (M€ /MW Bio Oil)	n.a.	2.78	1.58	1.15	0.93	75%	125%	75%	125%	C, F	5, 11
- equipment (%)	n.a.	75	75	75	75						
-installation (%)	n.a.	25	25	25	25						
Fixed O&M (M€ /MW/year Bio Oil)	n.a.	0.027	0.027	0.027	0.027	75%	125%	75%	125%	E, F	5
Variable O&M (€ /MWh Bio Oil)	n.a.	1.31	1.31	1.31	1.31	75%	125%	75%	125%	E, F	5
Start up (€ /l Bio Oil)	n.a.	0	0	0	0						
Technology specific data											
Specific energy content (GJ/ton)	43	43	43	43	43						
Specific density (kg/l) or (ton/m3)	0.78	0.78	0.78	0.78	0.78						
Specific investment (M€ /l1000 t Bio Oil)	n.a.	3.96	2.24	1.64	1.32	75%	125%	75%	125%	C, F	5, 11
- equipment (%)	n.a.	75	75	75	75						
-installation (%)	n.a.	25	25	25	25						
Fixed O&M (M€ /1,000 t Bio Oil)	n.a.	0.039	0.039	0.039	0.039	75%	125%	75%	125%	E, F	5
Variable O&M (€ /1,000 t Bio Oil)	n.a.	0.016	0.016	0.016	0.016	75%	125%	75%	125%	E, F	5
Start up (€ /l Bio Oil)	n.a.	0	0	0	0						

Notes:

- A. The plant size range is likely limited by the feedstock availability.
- A1. This value is the hourly rating and has been calculated as if the unit produces at capacity and was in operations 8,000 h/year.
- B. The plant size range is typical of the range found in the literature. It is highly uncertain given that there is no commercial demonstration plant in operation yet.
- C. Capital costs for nth plant are used for 2050 and earlier costs are estimates.
- D. These are based on extrapolated pilot plant results.
- E. Nth plant estimates
- F. M €/k tonne is million euro per 1,000 tonnes
- G. The values are prior to distillation into the diesel and gasoline fractions.
- H. The gas to diesel ratio could vary with the feedstock. The lignin is likely to produce heavier products (more diesel) than the cellulose.

A separate data sheet is provided for configuration 1. This is not a complete data set as this configuration is based on research studies and no scale up or costing of the configuration has been undertaken.

Catalytic Hydroprocessing Datasheet – Configuration 1:

Technology	Catalytic Hydroprocessing conf. 1										
	2015	2020	2030	2040	2050	Uncertainty (2020)		Uncertainty (2050)		Note	Ref
						Lower	Upper	Lower	Upper		
Energy/technical data											
Typical total plant size 1,000 t liquid fuels/year	n.a.	40	80	120	160	50%	125%	75%	125%	A, B	3, 4
Typical total plant size. MW	n.a.	57	114	171	228	50%	125%	75%	125%	A, A1, B	3, 4
Inputs											
Feedstock Consumption, MWh/MWh Total Input	n.a.	0.77	0.77	0.77	0.77	90%	150%	90%	125%	C	1
Hydrogen Consumption, MWh/MWh Total Input	n.a.	0.23	0.23	0.23	0.23	75%	125%	75%	125%	C	1
Outputs											
Liquid Fuel Output, MWh/MWh Total Input	n.a.	0.38	0.38	0.38	0.38	90%	110%	90%	110%	C	1
Biochar, Output, MWh/MWh Total Input	n.a.	0.13	0.13	0.13	0.13	90%	110%	90%	110%	C	1
Gas Output, MWh/MWh Total Input	n.a.	0.31	0.31	0.31	0.31	90%	110%	90%	110%	C	1
District Heat MWh/MWh Total Input	n.a.	0.18	0.18	0.18	0.18	90%	110%	90%	110%	C	1
Financial data											
Specific investment (M€ /1000 t Liquid Fuels)	n.a.	2.18	1.23	0.90	0.73	75%	125%	75%	125%	D, E, F	5, 11

- equipment (%)	n.a.	75	75	75	75						
-installation (%)	n.a.	25	25	25	25						
Fixed O&M (1,000 € /MW)	n.a.	44	44	44	44	0.75	1.25	0.75	1.25	E, F	5
Variable O&M (€ /MWh of fuel)	n.a.	0.02	0.02	0.02	0.02	0.75	1.25	0.75	1.25	E, F	5
Start up (€ /l Liquid Fuel)	n.a.	0	0	0	0						
Technology specific data											
Specific energy content (GJ/ton)		43.0									
Specific density (kg/l) or (ton/m ³)		0.83									

Notes:

A. The plant size range is likely limited by the feedstock availability.

A1. This value is the hourly rating and has been calculated as if the unit produces at capacity and was in operations 8,000 h/year.

B. The plant size range is typical of the range found in the literature. It is highly uncertain given that there is no commercial demonstration plant in operation yet.

C. These are based on extrapolated pilot plant results.

D. Tan [5] reports that the hydrogen plant and distillation account for 45% of the total plant costs for configuration 2. The cost for this configuration are therefore 55% of Configuration 2.

E. Nth plant estimates

F. M €/k tonne is million euro per 1,000 tonnes

References

- [1] Stummann, M., Høj, M., Schandel, C.B., Hansen, A.B., Wiwel, P., Gabrielsen, J., Jensen, P.A., Jensen, A.D.. 2018. Hydrogen assisted catalytic biomass pyrolysis. Effect of temperature and pressure. *Biomass and Bioenergy*. Volume 115, Pages 97-107. <https://doi.org/10.1016/j.biombioe.2018.04.012>.
- [2] Fan, J., Gephart, J., Marker, T., Stover, D., Updike, B., and Shonnard, D. 2016. Carbon Footprint Analysis of Gasoline and Diesel from Forest Residues and Corn Stover using Integrated Hydrolysis and Hydroconversion. *ACS Sustainable Chemistry & Engineering* **2016** 4 (1), 284-290. <http://doi.org/10.1021/acssuschemeng.5b01173>
- [3] Integrated Hydrolysis and Hydroconversion. <https://www.cricatalyst.com/cricatalyst/ih2/integrated-hydrolysis-and-hydroconversion.html>
- [4] Biozin AS. <http://biozin.no/>
- [5] Tan, E., Marker, T., Roberts, M. 2013. Direct Production of Gasoline and Diesel Fuels from Biomass via Integrated Hydrolysis and Hydroconversion Process—A Techno-economic Analysis. <https://doi.org/10.1002/ep.11791>
- [6] Thilakarathne, R., Brown, T., Li, Y., Hu, G., Brown, R. 2014. Mild catalytic pyrolysis of biomass for production of transportation fuels: a techno-economic analysis. *Green Chem.*, 2014, 16, 627. <http://doi.org/10.1039/c3gc41314d>
- [7] Mehta, D., Urade, V., Narasimhan, L., Rao, M., Del Paggio, A. 2015. Understanding Chemistry in the IH2[®] Process. http://www.gastechnology.org/tcbiomass/tcb2015/Mehta_Dhairya-Presentation-tcbiomass2015.pdf
- [8] Marker et al. 2012. Biomass to Gasoline and Diesel Using Integrated Hydrolysis and Hydroconversion. <https://www.osti.gov/servlets/purl/1059031>
- [9] Marker et al. 2015. Refinery Upgrading of Hydrolysis Oil from Biomass. <https://www.osti.gov/servlets/purl/1221922>
- [10] Marker et al. 2017. Catalytic Conversion of Cellulosic Biomass or Algal Biomass plus Methane to Drop in Hydrocarbon Fuels and Chemicals. https://www.energy.gov/sites/prod/files/2017/05/f34/thermochem_marker_2.3.1.411.pdf
- [11] Meerman, J., Larson, E. 2017. Negative-carbon drop-in transport fuels produced via catalytic hydrolysis of woody biomass with CO₂ capture and storage. *Sustainable Energy Fuels*, 2017,1, 866-881. <https://doi.org/10.1039/C7SE00013H>
- [12] Urade et al. 2015. Quality of Transportation Fuels from the IH2[®] Process. http://www.gastechnology.org/tcbiomass/tcb2015/Urade_Vikrant-Presentation-tcbiomass2015.pdf
- [13] Laxminarasimhan. 2018. An Introduction to Shell New Energies, and IH2[®] Technology –Drop in Fuels from Waste Biomass. https://ec.europa.eu/energy/sites/ener/files/documents/29_laxmi_narasimhan-ih2_advocacy_lead.pdf
- [14] Marker, T. L., Felix, L. G., Linck, M. B. and Roberts, M. J. 2012. Integrated hydrolysis and hydroconversion (IH²) for the direct production of gasoline and diesel fuels or blending components from biomass, part 1: Proof of principle testing. *Environ. Prog. Sustainable Energy*, 31: 191-199. <https://doi.org/10.1002/ep.10629>

102 Power to Jet Fuel

Contact Information:

Danish Energy Agency: Jacob Hjerrild Zeuthen, jhz@ens.dk and Filip Gamborg, fgb@ens.dk

Author: Don O'Connor – (S&T)² Consultants Inc.

Publication date

May 2020

Amendments after publication date

Date	Ref.	Description
07 2020		Minor adjustment in DH output for hydrogen to jet, note letters fixed and note added

Qualitative Description

The power to jet fuel technology described in this chapter utilizes electricity to produce hydrogen and the hydrogen is reacted with carbon dioxide (CO₂) to produce syngas (hydrogen (H₂) and carbon monoxide (CO)), which is then used in a Fischer-Tropsch (FT) process to produce syncrude or Fischer-Tropsch wax, which can subsequently be hydrocracked and upgraded through refinery processes to diesel, kerosene, jet fuel, other hydrocarbons, and heat.

The system can take several forms. There are several different electrolysis technologies, the carbon dioxide could come from many different sources, and there are several different technologies being developed for the conversion of carbon dioxide to carbon monoxide, which along with hydrogen is the reactant for the Fischer-Tropsch synthesis. There is also some research underway on the direct utilization of carbon dioxide rather than first producing carbon monoxide. There are other production methods for the production of emission free hydrogen, for example methane pyrolysis [1]; these are not described in this chapter.

This technology for direct conversion of power to jet fuel is at the early stage of development with only a few pilot plants that are operable, while conversion of syngas to Fischer-Tropsch wax and the subsequent upgrade has been in large-scale industrial operation for decades in South Africa, Malaysia and the Middle East. The plants have been developed by technology aggregators, who might have developed one of the subsystems but rely on other technology providers for the balance of the plant.

There are other power to jet routes that could be considered as well. The power and CO₂ could first be used to produce methanol, this can be accomplished without the conversion of the CO₂ to CO and was described in the Methanol from Power chapter. The methanol could be converted to olefins and then to light ends, gasoline, and jet fuel fractions [2]. The power to methanol production portion of the system has a higher TRL than the FT pathway but the subsequent conversion of methanol to hydrocarbons involves more process steps and has a lower TRL. This route is being explored by a Finish group of companies [3].

Brief Technology Description

Electricity is used to make hydrogen via electrolysis and carbon dioxide is reduced to carbon monoxide and water. The two streams are combined to produce a syngas, which is then synthesized through the Fischer-Tropsch reactions to produce liquid hydrocarbons and heat.

The basic process flow is shown in Figure 1.

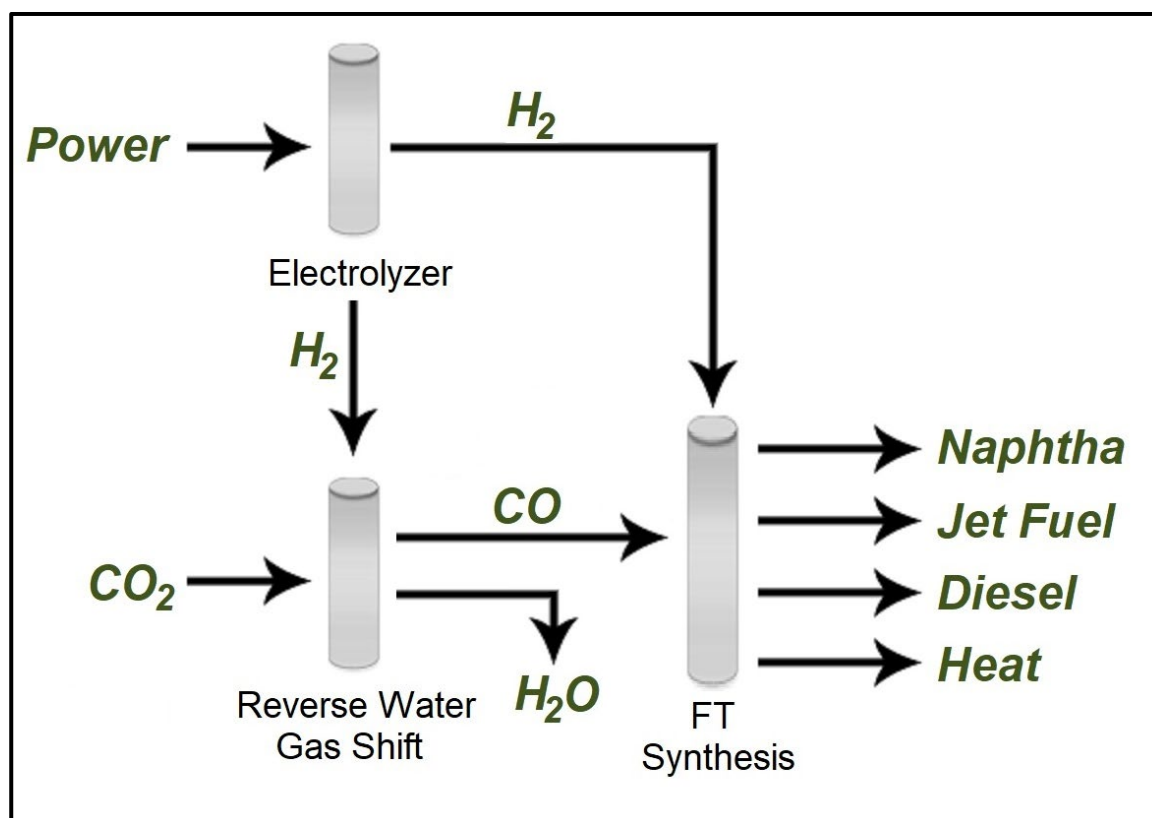

Figure 1: Power to Jet Process Flow

The water from the reverse water gas shift (RWGS) can be recycled back to the electrolyzer for hydrogen production.

There are a number of catalysts that can be used for the Fischer-Tropsch synthesis but iron and cobalt based catalyst are the most common. The iron catalysts typically operate in a temperature range of 300 to 350 °C and the cobalt catalysts operate at lower temperatures (200 to 240 °C) and both operate at pressures of 20 to 25 bar [4].

Input

The process inputs are electricity (for hydrogen production) and carbon dioxide. Data sheets at the end of the chapter are provided for both electricity as the input and for hydrogen as an input. Renewable sources

of electricity are preferred in order to reduce the greenhouse gas (GHG) emissions associated with the produced products. Some analyses include about 3% external fuel.

Cobalt catalysts required in situ regeneration every 9 to 12 months and replacement every five years [6]. Cobalt catalyst consumption rate of 0.0009 kg per kg of FT liquids produced was modelled in a recent lifecycle analysis of an FT system [7]. Iron catalysts have limited lifetimes of 40 to 100 days but are 1/1000th the cost of Cobalt catalysts. Large scale natural gas to FT plants employ multiple parallel reactors that can facilitate catalyst changes.

The carbon dioxide can be from concentrated sources such as ethanol fermentation facilities and ammonia plants, through medium concentration sources such as thermal power plants, and even to dilute sources such as direct air capture facilities. The energy requirements for the concept will increase as the concentration of the CO₂ sources decrease.

The FT synthesis actually needs carbon monoxide, not carbon dioxide, as one of the reactants. The traditional process to convert carbon dioxide to carbon monoxide is through the use of the reverse water gas (RWGS) shift reaction shown below. The process is described in more detail by Daza et al [8]. The reaction is endothermic (requires heat).

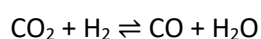

The reaction is undertaken at temperatures between 350 to 600°C, depending on the catalysts used and at relatively low pressures. The reaction is reversible so that there will always be some CO₂ in the gaseous stream leaving the reactor. Konig et al [5] designed for 80% conversion to CO in the RWGS and recycled the excess CO₂ from the FT synthesis back to the RWGS reactor.

It is also possible to use an electrochemical process to convert CO₂ to CO [9]. There is development work ongoing in this area, and Haldor Topsoe offers a small scale commercial product (eCOs). The reaction is shown below.



There is also work going on with thermochemical and photochemical CO₂ reduction processes but these are not yet commercially available [10] [11].

The FT synthesis process needs a H:C ratio of about 2, for example C₁₃H₂₈ (tridecane, a typical component of jet fuel) the ratio is 28:13 = 2.15 [4]. Considering the overall ratio, including the hydrogen required for the reverse water gas shift, the ratio for H:CO₂ required for the FT synthesis becomes about 3:1. There is a range of assumed carbon efficiencies in the literature. It is likely that early plants will have a higher ratio of hydrogen to CO and then improve over time.

Output

The Fischer-Tropsch synthesis is essentially a polymerization reaction in which carbon bonds are formed from carbon atoms derived from carbon monoxide, under the influence of hydrogen in the presence of a metal catalyst. The reaction leads to a range of products which depend on the reaction conditions and catalysts employed. The most abundant compound classes are paraffins,

olefins, and alcohols (oxygenates) as shown below [4]. The alcohols can be removed in the post reaction processing or used for energy to drive the process.

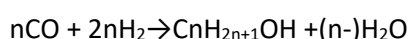
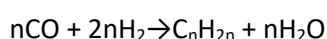
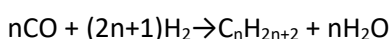

The FT reactions are not particularly selective and they typically make a range of alcohols, olefins and paraffinic hydrocarbons that range from light naphtha that could be used for gasoline production, through to jet fuel, diesel fuel and traditionally heavy waxes, which can be further processed into high quality lubricants. There can be trade-offs between liquid product yield and product selectivity. DeKlerk [4] reported the typical product range for different catalysts and operating conditions. The results are shown in the following table; jet fuel is composed of the heavy end of the naphtha and the light end of the diesel fuel (C8 to C16).

	Low temp Iron	Low temp Cobalt	High temp Iron
	Wt%		
C1 to C2 gas	6	7	23
C ₂ – C ₄	8	5	24
Oxygenates	4	2	10
Naphtha (C ₅ to C ₁₁)	12	20	33
Diesel (C ₁₂ -C ₂₀)	20	22	7
Wax (C ₁₈ –C ₁₀₀)	50	44	-
Total	100	100	97

Table 1: FT Synthesis Product Distribution

DeKlerk reports that the production of on-specification jet fuel is the easiest of the transport fuel types to accomplish. It is necessary that the paraffins in the kerosene range (C8 to C16) are sufficiently branched to meet the cold flow specification, which requires a freezing point below minus 47°C. It is also necessary to have (8-25) % aromatics in the kerosene range. On specification fully synthetic jet fuel as well as semi-synthetic (50% blend with crude oil derived kerosene) are produced on industrial scale from Fe-HTFT derived synthetic oil using fossil feedstocks.

A US Patent was issued to De Klerk [12] in 2014 for a process, which has FT jet fuel yield of 60%. The patent is assigned to Sasol in South Africa. The process includes at least four of the following five processes.

- a) Hydrocracking the kerosene or heavier fraction and a C9 or heavier FT Syncrude fraction.
- b) Olefin oligomerizing produces kerosene range material from lighter olefinic materials.
- c) Hydrotreating one or more of an FT syncrude fraction, a product from process b. , and an alkylated FT Syncrude fraction
- d) Aromatizing one or more of an FT syncrude fraction including hydrocarbons in the range C2 to C8 , a product from process a, a product from process b, a product from process c, and a product from an aromatic alkylation process.
- e) Alkylating one or more of an FT Syncrude fraction including hydrocarbons in the C2 to C6 range , a product from process b, and a product from process d

Such a process would add significantly to the capital cost of a facility. Many of the processes are typically found at a petroleum refinery so co-locating the Power to FT facility at a petroleum refinery may be an option to take advantage of the economies of scale typically found in petroleum refineries.

The FT reactions are also exothermic so some excess heat can be captured by the process. The total amount of excess heat is about 25% of the heat of combustion of the synthesis gas, which means that both significant energy is available for export, (up to 25% of the syngas input) and that there is a theoretical limit for the efficiency of the process (75%) [13]. König [5] reports that low (125 °C), medium (175 °C) and high (>200 °C) pressure steam is available from the FT process. Seventy percent of the steam is high pressure, seventeen percent is low pressure, with thirteen percent being medium pressure.

Energy Balance

The overall system energy balance will depend on the choices of technology that are employed.

For the hydrogen production there are three choices; Alkaline electrolyzers, which are the most common systems used today, polymer electrolyte membrane (PEM) electrolyzers, and solid oxide electrolyzer cells (SOEC), which use a solid ceramic material as the electrolyte that selectively conducts negatively charged oxygen ions (O_2^-) at elevated temperatures and generate hydrogen in a slightly different way.

Alkaline electrolyzers have the largest market share, they have no expensive noble metals (platinum, palladium, ruthenium, etc.) like PEM systems, but they have a lower efficiency than PEM or SOEC systems.

PEM systems typically have slightly higher efficiencies than alkaline systems, operate at a slightly lower temperature, but they use noble metals as the catalyst which can result in higher capital costs.

Solid oxide electrolyzers must operate at temperatures high enough for the solid oxide membranes to function properly (about 700°–800 °C, compared to PEM electrolyzers, which operate at 70°–90 °C, and commercial alkaline electrolyzers, which operate at 60°–80 °C). The solid oxide electrolyzers can effectively use heat available at these elevated temperatures (from various sources, including from the FT process) to decrease the amount of electrical energy needed to produce hydrogen from water. They are not yet used commercially. Further information is available in electrolysis chapters of the Danish Energy Agency Technology Catalogue.

Lehner et al [14] compared the characteristics of the systems and provided some advantages and disadvantages. This 2014 book has been cited over 200 times in the literature. It is possible that further technological advances have occurred with the technologies since publication, particularly with the developing technologies. Power requirements for electrolysis systems are not always quoted on a consistent basis. Not all reports will include ancillary loads for pumps and fans and some only quote the stack power requirements without including the losses from the conversion of AC to DC power. The size in the table refers to a module size; multiple modules could be used at a single site for increased capacity. These are summarized in Table 2.

	Alkaline	PEM	SOEC
Maturity	Mature	Commercial	Demonstration
Efficiency, kWh/m ³ H ₂ ⁴	4.5-6.6	4.2-6.6	>3.7
Mid-point Efficiency, % LHV	50%	52%	75%
Size, m ³ H ₂ /hr	<760	<40 ⁵	<40
Gas purity, %	>99.5	99.99	99.9
Capital costs, €/kw	1000-1200	1860-2320	>2000

Table 2: Electrolyzer System Comparison [14]

There are only two operating power to FT synthesis pilot plants [15] [16] and neither have publicly released any performance data and production rates are on the order of 100's of litres per day. Sunfire first produced FT distillates at their research facilities in Dresden Germany in 2015. They used CO₂ from direct air capture and a solid oxide electrolyzer to produce the hydrogen. They claimed up to 70% efficiency for the power to liquids technology but no detail of that calculation is publicly available. Carbon Engineering [15] also use direct air capture for the CO₂ but use an alkaline electrolyzer for hydrogen. They have also not provided any technical performance data. The energy balance must therefore be estimated from information in the literature.

There have been a number of papers and publications that have performed prospective techno-economic assessments of power to jet systems. The most detail was in the 2019 report "Nordic GTL" by Mortensen et al [19]. That study also reported the highest liquid fuel efficiency at 65% as a SOEC system was assumed. A 2016 report for the German Government by Schmidt et al [21] reported fuel efficiencies from 53 to 64% depending on the electrolysis system used. The World Energy Council [22] reported fuel efficiency of 45%, which they considered a realistic process efficiency considering an economic perspective. Konig et al [5] undertook process modelling and reported a 43.3% power to liquid efficiency and a 73.7% carbon efficiency, which is lower than reported in some other studies. Light fuel products that are generated by the FT synthesis are separated and used for fuel to drive the process, thus there are carbon losses from the system. See the mass balance detail figure in the Quantitative sections. This study included the product separation and upgrading to gasoline, diesel, and jet fuel.

⁴ The reference used standard cubic meters. A temperature of 15 °C (288.150 K; 59.000 °F) and a pressure of 101.325 kilopascals (1.0000 atm; 14.696 psi).

⁵ Hydrogenics, a producer of alkaline and PEM electrolyzers now has PEM systems as large as 1,000 m³H₂/hr.

The technology that is closest to being commercially available at a reasonable scale is the use of an alkaline electrolysis system and the reverse water gas shift reaction. The estimated energy balance for this system is shown below [19]. Carbon dioxide does not contain any energy but depending on the source of the CO₂, some energy may have been expended to capture and concentrate the CO₂. The distribution between losses and steam for district heat is our estimate. This reference did not include any external fuel.

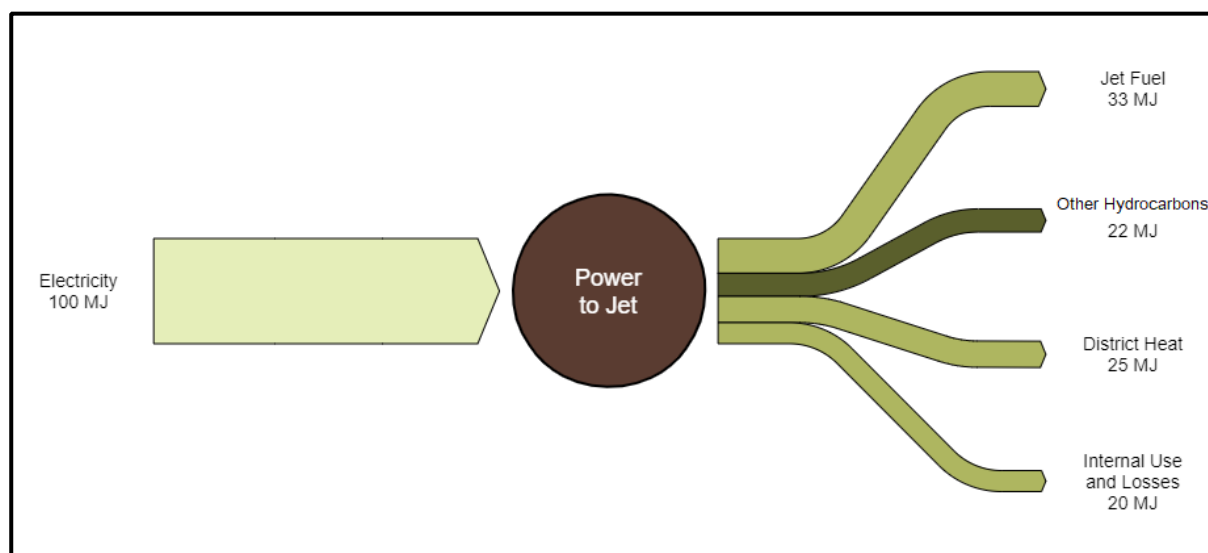

Figure 2: Power to Jet Fuel Energy Balance 2050 Projection

This energy balance has a higher jet fuel fraction than DeKlerk [4] and others have suggested. The other hydrocarbons will include gaseous hydrocarbons and liquids that are both lighter and heavier than jet fuel. Different FT systems could have different distributions of energy available for district heat versus own use.

Using the mid-point of the efficiency ranges reported by Lehner [14] which is shown in Table 2, which are representative of commercial systems, and the high end of the FT synthesis reported by [13] the following Table 3 can be developed. While the reverse water gas shift reaction is endothermic it has been assumed that this energy can be obtained from the exothermic FT synthesis.

	Alkaline	PEM	SOEC
kWh/m ³ H ₂ [270]	5.5	5.3	4
MJ electricity/m ³ H ₂	19.8	19.08	14.4
MJ H ₂ (LHV)/m ³	9.84	9.84	9.84
H ₂ Efficiency	50%	52%	68%
FT Synthesis Efficiency [13]	75%	75%	75%
Overall Efficiency	37%	39%	51%

Table 3: Potential System Efficiencies

From the table it would appear that some of the expected energy efficiencies in the publicly available feasibility studies [19] [21] [22] may be difficult to achieve in the first demonstration and commercial facilities.

Typical Capacities

The existing pilot plants have the capacity to produce 160 litres of fuel per day (~1 barrel). Commercial plants will be much larger.

The Schmidt study [21] looked at a plant that produced 123,000 tonnes per year of fuel (~150 million litres/year). The Nordic GTL study [19] was based on a plant that produced 190,000 tonnes of liquid fuels. Plants of this size are similar to commercial biodiesel or grain ethanol plants.

A plant that produces 150,000 tonnes of fuel will consume about 580,000 tonnes of CO₂ at a 95% carbon efficiency. It will need 400 MW of power.

Carbon Engineering has recently reported [23] that the first plants are likely to produce about 2,000 bbls/day of fuel and will utilize 1,000 tpd of CO₂. This is about 85,000 tonnes per year of fuel from 350,000 tonnes of CO₂ (this is about 75% carbon efficiency).

The first plants will likely be smaller than the plants studied in the literature.

Regulation Ability

There is little published on the performance of continuously operated plants. Given the high pressure and temperatures required in the reactors and the required reactor residence time it is likely that the performance will be altered when the process is operated at rates below the design capacity. Goldman et al [24] reported that the FT process (including the RWGS) has a low tolerance for variations in the supply of reactants and that hydrogen would need to be stored in excess to be available at a constant rate. The regulation ability will therefore have a linkage to the capital cost of the system. Overtoom [17] reported that the Shell FT plant in Malaysia requires two to three days to start the complex and to bring it to full production. During start-up the process is consuming energy without producing products and frequent start-up and shut down can have a significant negative impact on overall system efficiency and economic performance.

Space Requirements

The Schmidt report [21] calculated that the land requirements were 0.001 to 0.002 ha/GJ Jet fuel/year, however this included the land requirements for the wind power which is outside the scope of this chapter. A 4,000 bbl/day plant would require 7,000 to 14,000 ha according to this metric. The authors report that some of the land could still be used for agriculture.

Without any commercial scale plants in operation it is difficult to estimate the space requirements. The Pearl GTL plant in Qatar has a 140,000 bbl/day capacity and occupies 550 ha. It has 29 FT reactors, so each reactor would produce 4,800 bbl/day, which is 20% larger than the scale of the Nordic plant that was analyzed [19]. This suggests that the Nordic plant might require 20 ha. It is possible that the space requirements might be larger than this as the Qatar plant is part of a large petrochemical process and it might share some facilities with other operations and the power to jet fuel plant will have electrolyzers and probably some hydrogen storage.

The space requirements do not include any required space for CO₂ capture if that is part of the processing system.

Advantages/Disadvantages

The primary attractiveness of the technology is that the liquid fuel can have a very low GHG emission profile if the power is from a low carbon source such as wind, solar, or hydro.

The challenge with this technology will be that the availability of the low carbon electricity will likely be intermittent and since the fuel synthesis portion of the process likes to operate at a constant rate there will be a requirement for hydrogen storage to allow for operation when the power isn't available to produce the hydrogen. Hydrogen storage will increase the capital costs. Carbon dioxide storage might also be required depending on the stability of the supply source.

The FT process also does not have a high selectivity for jet fuel (or any of the liquid product components). In addition to producing jet fuel there will be significant quantities of gaseous fuels, gasoline, diesel fuel, and perhaps heavy waxes produced, depending on the catalysts used and the operating conditions. The heavy wax can be used as a feedstock to produce high quality lubricating oil base stocks. These products will also have low carbon intensity.

Environment

The GHG emission performance of the product will depend on the carbon intensity of the power use to produce the fuel. The carbon dioxide used to produce the fuel will be released when the fuel is combusted. One cannot generate carbon credits for the CO₂ capture and consider the combustion of the fuel from the process to be carbon neutral. In a lifecycle assessment only one of these options can be considered. That is, if CO₂ credits are issued for the CO₂ capture then the fuel combustion emissions are the same as a fossil fuel. It is important that if the CO₂ from the combustion is not counted in the system GHG emissions that there is no credit given for the use of the CO₂ going into the process.

The production of hydrogen by electrolysis also requires water. Schmidt [21] calculated a theoretical net process water demand of 0.8 litres per litre of jet fuel but estimated that in reality the demand would be 1.3 to 1.4 litres per litre of jet fuel produced. Water is produced in the reverse water gas shift process that can be recycled back to the electrolysis step.

There is some evidence that FT jet fuels may reduce soot formation compared to crude oil based jet fuels [20]. With fewer soot particles, it is likely but not yet proven that jet planes would form thinner, less dense contrails and cirrus clouds, which would reduce their contribution to global warming.

Research and Development Perspective

Power to jet fuel is a category 1 technology, a technology in the research, development and deployment stage. The individual components (electrolysis, RWGS, FT synthesis) of the process are mature technologies

but they have not been combined nor commercialized at the scale envisioned for this technology. There is significant uncertainty with respect to the performance and costs of the technology.

There is potential to improve yields and reduce costs as more experience with the technology is gained from a demonstration facility and then the technology is scaled to commercial plants.

Examples of Market Standard Technology

There are two companies that have built power to FT fuel pilot systems. Both systems are capable of producing about 160 litres of liquid fuels per day.

Sunfire GmbH develops and manufactures high-temperature electrolyzers (SOEC) and high-temperature fuel cells (SOFC). They work with Ineratec GmbH who convert the hydrogen and CO₂ to liquid fuels. They have also worked with Climeworks to include direct air capture to produce the CO₂ for the system. KIT have also been involved with the German Government funded P2X Kopernikus project [25].

Sunfire GmbH

Gasanstaltstraße 2

01237 Dresden, Germany

T: +49 351 896797-0

<https://www.sunfire.de/en/>

INERATEC GmbH

Innovative Chemical Reactor Technologies

Siemensallee 84

76187 Karlsruhe

Germany

T: +49 721 / 864 844 60

<https://ineratec.de/en/home>

The other company that has developed a pilot plant is Carbon Engineering in Canada. Their core area of expertise is the direct air capture system and they have partnered with Hydrogenics for the electrolysis and Greystone for the FT synthesis step.

Carbon Engineering Ltd.

PO Box 187,

37322 Galbraith Road,

Squamish, B.C.,

Canada

V8B 0A2

<https://carbonengineering.com>

Greyrock

2020 L Street, Suite 120

Sacramento, California 95811

<http://www.greyrock.com/>

Sasol and Haldor Topsoe, have entered into a collaboration agreement to offer G2L™- single-point licensing of GTL solutions to produce diesel, kerosene and naphtha from natural gas. The two companies have worked together on numerous GTL projects and technologies, and Topsoe's SynCOR™ technologies and Sasol's Fischer-Tropsch technologies have been licensed into several world-scale GTL ventures. Under the collaboration agreement, the companies will continue to offer these core technologies and will now also provide Topsoe's hydroprocessing and hydrogen technologies.

Haldor Topsoe A/S (HQ)

Haldor Topsøes Allé 1

DK-2800

Kgs. Lyngby

Denmark

<https://www.topsoe.com/>

Prediction of Performance and Cost

There have been several techno-economic studies done on the concept of power to jet fuel. In addition to the technical analyses already identified in this chapter the report by Frontier Economics for Agora Energiewende contains some economic analysis for the years 2020, 2030, and 2050 [26].

The capital cost estimates that have been reported in the literature could be categorized as Class 5 or Class 4 estimates [27]. The Cost Estimate Classification System maps the phases and stages of project cost estimating together with a generic maturity and quality matrix, which can be applied across a wide variety of industries. The classes range from 1 (Check Estimate or Bid/Tender with Detailed Unit Cost and Detailed Take-Off) to class 5 (Concept screening using factored parametric models or judgement).

Class 5 estimates have uncertainty on the low end of -20 to -50% and on the high end of +30 to +100%. Class 4 capital cost estimates are feasibility type estimates with slightly narrower ranges of -15 to -30% on the low end and +20 to +50% on the high end of the range.

Uncertainty

There is significant uncertainty with respect to both economics and the performance due to the stage of the development of the technology. There is a significant range for performance and costs found in the literature.

The capital cost estimates have a wide range due to the early stage of development of the concepts. It is more likely that capital costs will be above the central estimates rather than below the estimates.

Both of the main technologies (electrolysis and FT synthesis) have uncertainty. In the case of the electrolysis there are three potential technologies. The mature alkaline electrolysis which can be characterized by lower cost and efficiency, the emerging PEM systems which have higher cost and efficiency, and the solid oxide electrolytic cells which have the highest efficiency, highest cost and the lowest TRL.

FT synthesis stage which is employed commercially in large scale fossil production systems but not yet at smaller scale electrofuel systems where liquid fuel selectivity will be important to keep the system cost and complexity at reasonable levels. The range of selectivity was shown in

Additional Remarks

There are a number of different FT catalysts that are used commercially or have been developed for commercial use. Commercial FT catalyst suppliers include Johnson Mathey, UOP, CRI/Criterion (Shell), and BASF. The catalyst can have different optimum operating conditions and produce fuels of different quality. One of the challenges of FT jet fuel is that it has a very low aromatics content and some aromatics in jet fuel are required to prevent elastomeric seals from shrinking. Currently FT jet fuel is only approved as a blend of up to 50% with the remainder being crude oil derived jet fuel. The comparison of the properties of the two fuels is summarized in the following table [28]. Fossil JP-8 is the military equivalent to Jet A-1 but has some corrosion and anti-icing additives, the additives don't impact the properties in the table.

	FT Jet Fuel	Fossil JP-8 Fuel (Jet A-1)
Flash Pt., °C	54	48
Density, kg/L	0.754	0.794
Aromatics, vol. %	<1	19.7
Sulfur, mass %	<0.002	0.08
Freeze Pt., °C	-52	-49
Visc., 40°C	1.4	1.3
Simulated Distillation., °C		
Initial Boiling Point	131	109
10%	156	159
90%	272	251

95%	282	259
Final Boiling Point	332	282
Cetane Index	70	47

Table 4: Comparison of Fuel Properties Between FT Jet and Fossil Jet

The FT jet fuel has lower aromatics (which is one of the reasons that it is blended with crude oil derived jet fuel to avoid seal shrinkage), lower sulphur, and much higher cetane value.

Quantitative Description

Since there are no plants operating at a large scale, the quantitative information on the process is synthesized from the literature and presented below.

Energy/Technical Data

The Mortensen [19] and Schmidt [21] reports have the most complete set of technical and economic data and are used as the basis for the quantitative information presented. There is a fundamental difference between the assumptions made in the two reports, The Schmidt report assumes less than 4,000 hours per year of operation whereas the Mortensen report assumes almost 8,000 hours per year of operation for the FT synthesis portion of the plant. Operation of 8,000 hr/year would likely require large scale hydrogen storage, or as Mortensen assumes a hybrid concept with the alternative supply of synthesis gas from methane. The Schmidt report explicitly includes capital for hydrogen storage (in one scenario) whereas the Mortensen report is silent on the issue.

Typical Plant Size

The technology has not yet moved beyond the pilot plant stage. These pilot plants could produce 50,000 litres per year of liquid fuels if they were operated continuously. Not all of this would be jet fuel. Commercial plants will have to be larger to be economical. A possible progression of plant sizes are shown in the following table. It is assumed that the plants operate for 8,000 hours per year, that 5.5 kWh of power produces a cubic meter of hydrogen, one mole of CO₂ requires 3 moles of hydrogen and the FT synthesis process has a 95% carbon efficiency.

Input Power MW for Hydrogen	H ₂ Required, tonnes/year	CO ₂ required tonnes/year	Liquid Fuel Litres ⁶ /year
50 (Alkaline)	6,000	46,000	18,000,000
150 (PEM)	18,000	138,000	55,000,000
600 (SOEC)	72,000	552,000	222,000,000

Table 5: Typical Plant Size

⁶ Liquid Fuel equivalents, some gaseous hydrocarbons will be produced and these are converted to liquid fuel equivalents based on their energy content.

The FT synthesis and the reverse water gas shift processes are chemical processes and should benefit from larger plants through economies of scale, although the Shell Pearl GTL plant has 24 reactors [29] which will limit the economies of scale achievable from larger reactors.

The production of hydrogen through electrolysis has limited potential for economies of scale. The more efficient PEM and SOEC electrolyzers are currently smaller than the alkaline systems and will require more modules for the same hydrogen production rate.

The economies of scale will also be impacted by the quantity of CO₂ available at a single site unless CO₂ pipelines are developed to collect CO₂ from multiple sources.

Input and Output

The high level input and output are shown in Table 5: Typical Plant Size. The detailed output will depend on the design of the FT synthesis process as shown in

District heat in the form of steam can be recovered from the FT synthesis step (~15% of energy in the FT products). It can also be recovered from the electrolysis stage. The quantity and quality will be a function of the type of electrolyzer used.

Konig [5] developed a detailed mass balance based on the process simulations undertaken in his study. That figure is shown in Figure 3. There is a small amount of external fuel for the system and some steam, although it should be possible to generate the steam internally.

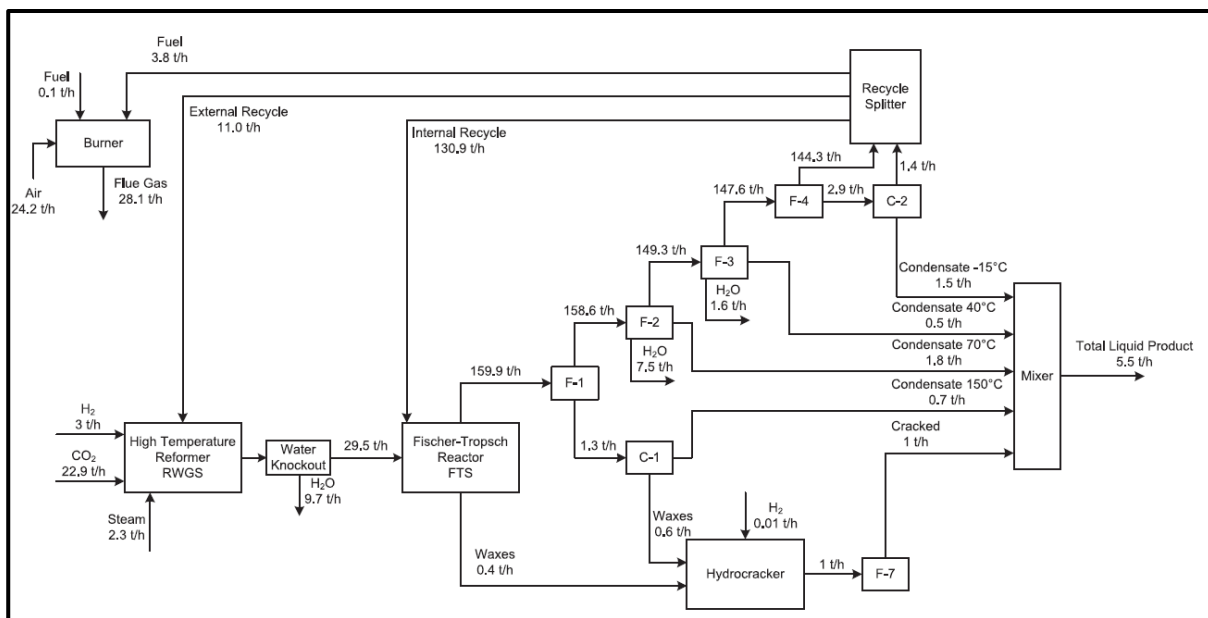

Figure 3: Mass Balance

Forced and Planned Outage

The Mortensen report assumed that the plant has 93% online availability. This is 340 days per year. The Schmidt report [270] appears to be based on only 3,750 hours per year of operation. They include some capital for hydrogen storage when the hydrogen is produced by low temperature electrolysis but not when it is produced by high temperature electrolysis (SOEC). Hydrogen production by SOEC would utilize the excess heat from the FT synthesis to produce the hydrogen, thus both systems must operate at the same time.

Technical Lifetime

Plants of this type would normally be designed for at least a 20 year lifetime. The Mortensen techno-economic study assumed a 25 year life.

Construction Time

Construction periods of 2-3 years are typical for large complex thermochemical production facilities. Smaller plants will take less time and there may be some technology learning with multiple plants.

Financial Data

There is limited financial data available for the process. The information from the two studies [19] [21] are mostly used below.

Investment Costs

There are two other estimates of capital costs, Schmidt also published a paper [30] in addition to the report for the German government, most of the information is the same except that the paper also had a capital cost for a 60 MW plant. The Agora [26] report also has some capital cost estimates but with very little detail. The various estimates are shown in the following table. The plant size is the MW of power input. Schmidt assumes very little technology learning between 2020 and 2050.

	Plant Size, MW	Year	Capital, million €	Capital per MW
Schmidt [21]	588	2020	308	0.52
Schmidt [21]	613	2040	322	0.52
Schmidt [30]	60	2020	84	1.4
Schmidt [30]	588	2050	308	0.52
Mortensen [19]	449	2030	407	0.91
Agora [26]	Not stated	2020	Not stated	1.3
Agora [26]	Not stated	2030	Not stated	1.1
Agora [26]	Not stated	2050	Not stated	0.83

Table 6: Capital Costs

The breakdown of the capital cost in the Schmidt paper is shown in the following table. These are for the utilization of a concentrated source of CO₂ and exclude any capital costs for CO₂ capture and concentration.

	Low temperature Electrolysis	High temperature Electrolysis
Power Input, MW	588	613
Fuel Output, kt/year	97	123
Efficiency	53%	64%
Electrolysis, M€	140	159
H ₂ Storage, M€	30	0
CO ₂ Supply, M€	45	53
Synthesis and Conditioning, M€	94	111
Total, M€	308	322
M€/MW input	0.52	0.53
M€/kt fuel output	3.2	2.6

Table 7: Capital Cost Breakdown

Operating and Maintenance Costs

There is even less information on the operating and maintenance costs. Mortensen assumed that the Fixed O&M costs were 5% of the capital costs and that the variable costs were 1.5% of the capital costs. Agora assumed that operating costs were 3% of the capital costs but did not differentiate between fixed and variable costs.

Start-up Costs

None of the reports identified start-up costs or time. We have assumed that 3 months are required, similar to the assumptions made in other chapters.

Technology Specific Data

There is very little technology specific data available for this process. Wu et al [31] reported some of the physical properties of gas to liquids diesel fuels. These values are shown in Table 8.

Property	Units	Value
Density	Kg/m ³	779
Lower Heating Value	MJ/kg	43.6
	MJ/litre	34.0
	kWh/litre	9.44
Carbon	Wt %	84.9
Hydrogen	Wt %	15.1

Table 8: Properties of FT Fuels

Summary

The information on power to jet fuel is summarized in the following table.

Technology	Power to Jet Fuel									
	2020	2030	2040	2050	Uncertainty (2020)		Uncertainty (2050)		Note	Ref
					Lower	Upper	Lower	Upper		
Energy/technical data										
Typical total plant size 1,000 t FT Liquids/year	2	13	41	165	50%	150%	50%	150%	A, B, C	19, 21, 23
Typical total plant size, MW Output	3.1	20.5	64.5	259.6	50%	150%	50%	150%	A,B,C	19, 21
Inputs										
CO ₂ Consumption, t/t FT Liquids	4.3	3.9	3.6	3.3	100%	110%	100%	110%	D, E	
Electricity Consumption, MWh/MWh Total Inputs	1.0	1.0	1.0	1.0	100%	100%	100%	100%	F	
Outputs										
FT Liquids Output, MWh/MWh Total Input	0.37	0.40	0.50	0.55	80%	120%	80%	120%	G, H, O	21, 19
District Heat Output, MWh/MWh Total Input	0.43	0.40	0.30	0.25	80%	120%	80%	120%	I	
Forced outage (%)	0	0	0	0					J	
Planned outage (weeks per year)	3									19
Technical lifetime (years)	25				20	30				
Construction time (years)	2.0									
Financial data										
Specific investment (M€ /MW Output)	3.2	2.5	1.9	1.6	75%	150%	75%	125%	K	19, 21, 26, 30
- equipment (%)	75	75	75	75					L	
-installation (%)	25	25	25	25						
Fixed O&M (€ /MWh FT Liquids)	26.5	15.9	10.6	5.3	90%	110%	90%	110%	M	19
Variable O&M (€ /MWh FT Liquids)	8.5	5.3	3.2	2.1	90%	110%	90%	110%	N	26
Start up (€ /MWh FT Liquids)	0	0	0	0						
Technology specific data										
Specific investment (€ /l FT Liquids/year)	5.0	4.0	3.0	2.5	75%	150%	75%	125%	K	19, 21, 26, 30
- equipment (%)	75	75	75	75					L	
-installation (%)	25	25	25	25						
Fixed O&M (€ /l FT Liquids)	0.25	0.15	0.10	0.05	90%	110%	90%	110%	M	19
Variable O&M (€ /l FT Liquids)	0.08	0.05	0.03	0.02	90%	110%	90%	110%	N	26
Start up (€ /l FT Liquids)	0	0	0	0						

Table 9: Power to Jet Fuel Datasheet

Notes:

- A. The plant size range is based on the Schmidt and Mortensen reports and other analysis in the literature. Scale up is our assumption.
- B. CO₂ availability is likely to determine the maximum plant size.
- C. Conversion to MW is based on 8,000 operating hours per year and the energy output in all liquid fuels. The conversion is rounded. Some reports are based on only 4,000 hours of operation. Figure 1-2 utilizes the 2050 estimates.
- D. Carbon efficiency in the literature ranges from 75 to 95%. Assuming that the early plants have low carbon efficiency and increase over time.
- E. Denominator of FT liquids is the total liquid fuel output.
- F. Power is the only energy input. Power will be required for pumping, compression, and utilities in addition to hydrogen production.
- G. FT Liquids efficiency increases as hydrogen production efficiency increases with adoption of more efficient technologies. 2020 and 2030 assume alkaline electrolysis, 2040 is based on PEM systems, and 2050 assumes SOEC. Limited improvement in FT synthesis assumed, although jet fuel selectivity may improve over time.
- H. Own calculations.
- I. Some heat is lost in the process to drive the RWGS reaction. Assumes that total losses and internal consumption is 20% of the input. The quality of the district heat will depend on the electrolysis technology employed. The FT portion of the process will have excess steam available. The quantity and quality of the steam will depend on the FT process employed and the plant configuration.
- J. This will depend on the level of hydrogen storage and the frequency of low surplus electricity periods that are outside of the range used for the calculation of the required hydrogen storage.
- K. The capital costs drop as plant size increases and through technological learning. Hydrogen storage costs are included (10% of capital costs) but not sized in the reference. No CO₂ storage is assumed.
- L. Own Assumption
- M. Based on 5% of capital cost.
- N. Based on 1.5% of capital cost. Excludes cost of power and carbon dioxide.
- O. A reasonable distribution of the FT fuels might be 60% jet fuel, 20% gasoline, and 20% lighter products (LPG and fuel gas), but the distribution of outputs could be very different depending on the plant design, catalyst and the operating conditions.

The information on hydrogen to jet fuel is summarized in the following table.

Technology	Hydrogen to Jet Fuel									
	2020	2030	2040	2050	Uncertainty (2020)		Uncertainty (2050)		Note	Ref
					Lower	Upper	Lower	Upper		
Energy/technical data										
Typical total plant size 1,000 kt FT Liquids/year	2	13	41	165	50%	150%	50%	150%	A, B,	19, 21, 23
Typical total plant size, MW Output	3.1	20.5	64.5	259.6	50%	150%	50%	150%	A,B,C	19, 21
Inputs										
CO ₂ Consumption, t/t FT Liquids	4.3	3.9	3.6	3.3	100%	110%	100%	110%	C, D, E	
Hydrogen Consumption, MWh/MWh Total Inputs	0.995	0.995	0.995	0.995	75%	125%	75%	125%	E	
Power Consumption, MWh/MWh Total Inputs	0.005	0.005	0.005	0.005	75%	125%	75%	125%	E	
Outputs										
FT Liquids Output, MWh/MWh Total Input	0.65	0.70	0.73	0.75	80%	120%	80%	120%	F, G, O	21, 19
District Heat Output, MWh/MWh Total Input	0.40	0.37	0.27	0.25	80%	120%	80%	120%	H	
Forced outage (%)	0	0	0	0					I	
Planned outage (weeks per year)	3									19
Technical lifetime (years)	25									
Construction time (years)	2.0									
Financial data										
Specific investment (M€ /MW Liquids/year)	2.1	1.6	1.1	0.9	75%	150%	75%	125%	G, J	19, 21, 26, 30
- equipment (%)	75	75	75	75					K	
-installation (%)	25	25	25	25						
Fixed O&M (€ /MWH Liquids)	16.9	12.7	8.5	7.4	90%	110%	90%	110%	L	19
Variable O&M (€ /MWH Liquids)	5.3	4.2	3.2	2.1	90%	110%	90%	110%	M	26
Start up (€ /l FT Liquids)	0	0	0	0						
Technology specific data										
Specific investment (€ /l FT Liquids/year)	3.3	2.5	1.7	1.4	75%	150%	75%	125%	G, J	19, 21, 26, 30
- equipment (%)	75	75	75	75					K	
-installation (%)	25	25	25	25						
Fixed O&M (€ /l FT Liquids)	0.16	0.12	0.08	0.07	90%	110%	90%	110%	L	19
Variable O&M (€ /l FT Liquids)	0.05	0.04	0.03	0.02	90%	110%	90%	110%	M	26
Start up (€ /l FT Liquids)	0	0	0	0						

Table 10: Hydrogen to Jet Fuel Datasheet

Notes:

- A. The plant size range is based on the Schmidt and Mortensen reports and other analysis in the literature. Scale up is our assumption.
- B. CO₂ availability is likely to determine the maximum plant size.
- C. Conversion to MW is based on 8,000 operating hours per year and the energy output in all liquid fuels. The conversion is rounded. Some reports are based on only 4,000 hours of operation. Figure 1-2 utilizes the 2050 estimates.
- D. Carbon efficiency in the literature ranges from 75 to 95%. Assuming that the early plants have low carbon efficiency and increase over time.
- E. Denominator of FT liquids is the total liquid fuel output.
- F. Hydrogen and power are the only energy input. Power will be required for pumping, compression, and utilities in addition to hydrogen production. Power estimated based on typical electric demand in petroleum refineries.
- G. FT Liquids efficiency increases as hydrogen production efficiency increases with adoption of more efficient technologies. 2020 and 2030 assume alkaline electrolysis, 2040 is based on PEM systems, and 2050 assumes SOEC. Limited improvement in FT synthesis assumed, although jet fuel selectivity may improve over time.
- H. Own calculations.
- I. Some heat is lost in the process to drive the RWGS reaction. Assumes that total losses and internal consumption is 10% of the input. The quality of the district heat will depend on the electrolysis technology employed. The FT portion of the process will have excess steam available. The quantity and quality of the steam will depend on the FT process employed and the plant configuration.
- J. This will depend on the level of hydrogen storage and the frequency of low surplus electricity periods that are outside of the range used for the calculation of the required hydrogen storage.
- K. The capital costs drop as plant size increases and through technological learning. Hydrogen storage costs are included (10% of capital costs) but not sized in the reference. No CO₂ storage is assumed.
- L. Own Assumption
- M. Based on 5% of capital cost.
- N. Based on 1.5% of capital cost. Excludes cost of power and carbon dioxide.
- O. A reasonable distribution of the FT fuels might be 60% jet fuel, 20% gasoline, and 20% lighter products (LPG and fuel gas), but the distribution of outputs could be very different depending on the plant design, catalyst and the operating conditions.

13. Speight, J. G. (2014). *The Fischer–Tropsch Process. Gasification of Unconventional Feedstocks*, 118–134. <https://doi.org/10.1016/b978-0-12-799911-1.00005-4>
14. Lehner, M., Tichler, R., Steinmüller, H., & Koppe, M. (2014). *Power-to-Gas: Technology and Business Models. SpringerBriefs in Energy*. <https://doi.org/10.1007/978-3-319-03995-4>
15. Carbon Engineering. 2017. Pilot demonstration of AIR TO FUELS™ technology. <https://carbonengineering.com/history-trajectory/>
16. Sunfire. 2019. Carbon-Neutral Fuels From Air and Electric Power. <https://www.sunfire.de/en/company/news/detail/carbon-neutral-fuels-from-air-and-electric-power>
17. Overtoom, R., Fabricius, N. and Leenhouts, W., 2009, January. Shell GTL, from bench scale to world scale. In Proceedings of the 1st Annual Gas Processing Symposium (pp. 378-386). <https://doi.org/10.1016/B978-0-444-53292-3.50046-8>
18. Sunfire. 2015. Sunfire Now Produces Synthetic Fuel From Air, Water And Green Electrical Energy. https://www.sunfire.de/en/company/news?file=files/sunfire/images/content/company/press/archive/2015_Apr_Sunfire%20now%20produces%20synthetic%20fuel%20from%20air.pdf
19. Mortensen, A.W., Wenzel, H., Rasmussen, K.D., Justesen, S.S., Wormslev, E. and Porsgaard, M., 2019. Nordic GTL: A pre-feasibility study on sustainable aviation fuel from biogas, hydrogen and CO₂. https://portal.findresearcher.sdu.dk/files/155625931/Nordic_aviation_fuel_production_28_10_2019_final.pdf
20. NASA. 2017. NASA test: Jet biofuel may reduce climate-warming clouds. <https://climate.nasa.gov/news/2601/nasa-test-jet-biofuel-may-reduce-climate-warming-clouds/>
21. Schmidt, P., Weindorf, W., Roth, A., Batteiger, V. and Riegel, F., 2016. Power-to-liquids—Potentials and perspectives for the future supply of renewable aviation fuel. *German Environment Agency*, pp.1-32. https://www.umweltbundesamt.de/sites/default/files/medien/377/publikationen/161005_uba_hintergrund_ptl_barrierrefrei.pdf
22. World Energy Council. 2019. International Perspective on Powerfuels. https://www.powerfuels.org/fileadmin/gap/Downloads/Praesentationen/Global_Alliance_Powerfuels_Carsten_Rolle.pdf
23. Carbon Engineering. 2019. Carbon Engineering Introduction. https://ww3.arb.ca.gov/cc/scopingplan/meetings/121119/ce_cn_ccapture_dec2019.pdf
24. Goldmann, A., Sauter, W., Oettinger, M., Kluge, T., Schröder, U., Seume, J., Friedrichs, J. and Dinkelacker, F., 2018. A Study on Electrofuels in Aviation. *Energies*, 11(2), p.392. <https://www.mdpi.com/1996-1073/11/2/392/pdf>
25. P2X Kopernikus project. <https://www.kopernikus-projekte.de/en/projects/power2x>
26. Agora Verkehrswende, Agora Energiewende and Frontier Economics (2018): The Future Cost of Electricity-Based Synthetic Fuels. <https://www.agora-energiewende.de/en/publications/the-future-cost-of-electricity-based-synthetic-fuels-1/>

27. AACE International. 2005. Cost Estimate Classification System – As Applied In Engineering, Procurement, And Construction For The Process Industries. https://www.costengineering.eu/Downloads/articles/AACE_CLASSIFICATION_SYSTEM.pdf
28. Muzzell, P., Sattler, E., Terry, A., McKay, B., Freerks, R., & Stavinoha, L. 2006. Properties of Fischer-Tropsch (FT) Blends for Use in Military Equipment. <https://doi.org/10.4271/2006-01-0702>.
29. Shell. Introduction To Pearl Gtl. https://www.shell.com.qa/en_qa/about-us/projects-and-sites/pearl-gtl.html
30. Schmidt, P., Batteiger, V., Roth, A., Weindorf, W. and Raksha, T., 2018. Power-to-Liquids as Renewable Fuel Option for Aviation: A Review. *Chemie Ingenieur Technik*, 90(1-2), pp.127-140. <https://doi.org/10.1002/cite.201700129>
31. Wu, T., Huang, Z., Zhang, W.G., Fang, J.H. and Yin, Q., 2007. Physical and chemical properties of GTL– diesel fuel blends and their effects on performance and emissions of a multicylinder DI compression ignition engine. *Energy & Fuels*, 21(4), pp.1908-1914. <https://doi.org/10.1021/ef0606512>

103 Green Ammonia

Contact Information:

Danish Energy Agency: Christoph Wolter, chwo@ens.dk

Author: Anne Krog Jensen (COWI)

Publication date

February 2021

Amendments after publication date

Date	Ref.	Description
04 2021		Adjustments in datasheet regarding specific energy content and minor clarifications in terms of naming

Abbreviations

1. REF	Primary reformer (=SMR)	LNH3	Liquified NH ₃
2. REF	Secondary reformer	LTS	Low temperature shift (=low temperature water gas shift)
AEC	Alkaline electrolysis cell		
ASU	Air separations unit	METH	MethanizationN2-EU
ATR	Autothermal reformer		Electrochemical synthesis NH ₃
BAT	Best Available Technology	MOF	Metal organic framework
BFW	Boiler Feed Water	MTPD	Metric ton per day
BOP	Balance of plant (utilities)	NH3syn	NH ₃ synthesis
CC	Carbon capture	NH3rec	NH ₃ recovery unit
CO2rem	CO ₂ removal unit	NH3reg	NH ₃ refrigeration unit
DeOX	De-Oxygenation unit	PEM	Proton Exchange Membrane electrolysis cell
DH	District heating		
EIGA	European industrial gases association AISBL	PUR	Feed purification unit
		RE	Renewable power
EU	Electrolysis Unit	SOEC	Solid oxide electrolysis cell
FG	Fuel gas	SMR	Steam Methane Reforming (typically = 1.REF)
HC-feed	Hydrocarbon feed (normally fossil based but can also be bio-based)	TPD	Ton per day
HPS	High pressure steam	TRL	Technology reediness level
HSE	Health safety and environment	WGS	Water gas shift
HTS	High temperature shift (=high temperature water gas shift)		

Qualitative Description

Today nearly all industrial production of ammonia is based on the Haber-Bosch process, where elemental nitrogen and hydrogen are combined under high pressure and temperature using a catalyst. Whereas nitrogen can be recovered from ambient air, the hydrogen is predominantly produced by steam reforming of natural gas (methane), a process that results in large emissions of fossil CO₂. Thus, reducing the CO₂

emissions from ammonia production is heavily linked to reducing emissions from hydrogen production. This can be achieved by capturing and storing CO₂ from conventional hydrogen production or alternatively substituting the conventional production of hydrogen with green hydrogen from electrolysis based on renewable energy.

In this chapter of the Technology Catalogue a brief description of the different NH₃ production paths is given. Thereafter, the catalogue focusses on the production of green ammonia.

Green ammonia has various applications and is primarily thought to be a carbon-neutral solution for shipping as a maritime transport fuel as well as to be used as feedstock for green fertilizers. It can potentially also be considered for applications in fuel cells, long-term energy storage, fuel for industry and peak power plants, or as an addition/mixture to conventional fuel among others.

Green ammonia incorporates electrolysis for H₂ production, air separation unit (ASU) for nitrogen production and the ammonia synthesis (see light green box in Figure 1). Within this catalogue, performance and cost data are given for the ammonia synthesis. Cost and performance data for the electrolysis are given in a separate chapter within this Technology Catalogue. For ASU as a nitrogen source, cost and performance factor is given discretely within this chapter.

Brief technology description

Different production routes to ammonia, i.e. both conventional and green paths, are given in Figure 1. While the overall routes are described in subsection *Different configurations*, each process step (i.e. dark blue boxes) is described in subsection *Description of each process step*.

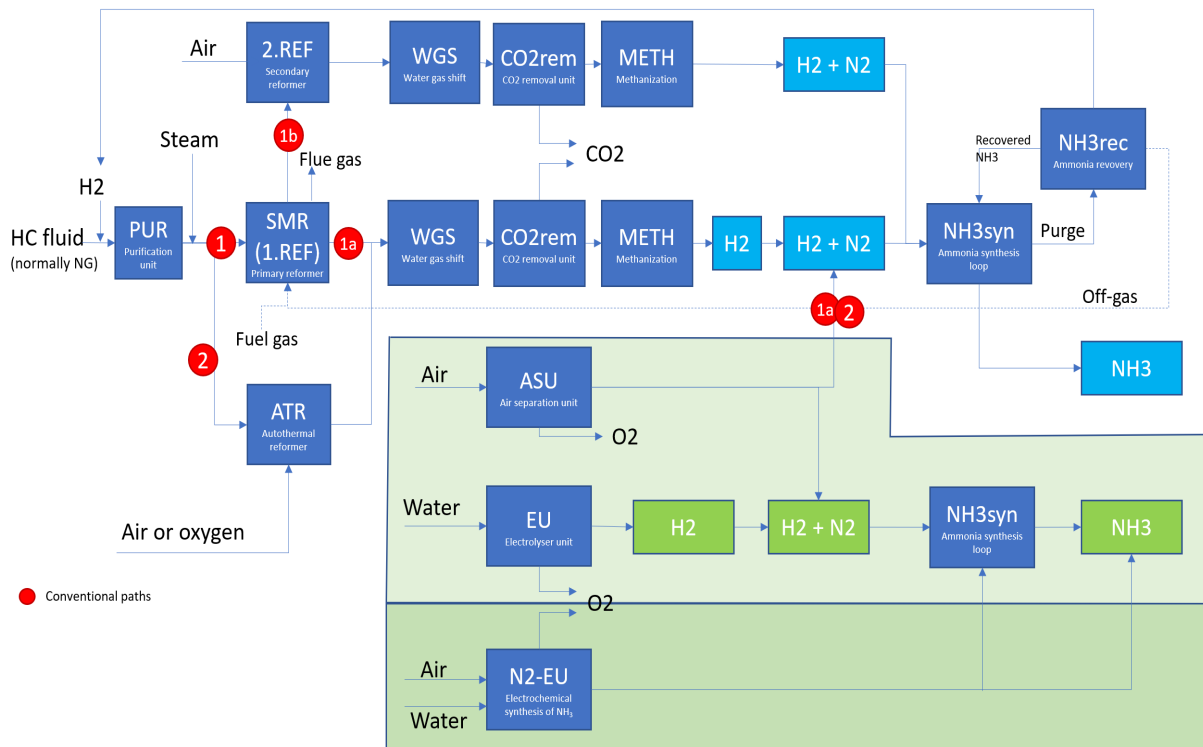

Figure 1: Different pathways for production of NH₃. The light green area is the green NH₃ production part that is covered within this Technology Catalogue. The darker green area marks a potential future route (electrochemical). The white background shows the three conventional parts, i.e. 1a) SMR+ASU, 1b) SMR+2.REF and 2) ATR+ASU.

Different configurations

1) Conventional – grey NH₃

A conventional ammonia plant uses fossil fuels (in most cases natural gas) as its raw material.

Figure 2 shows a conventional NH₃ plant based on primary and secondary reformer technology, where nitrogen is admitted via air to the secondary reformer. Alternative reformer configuration is autothermal reformer (ATR) or single steam methane reformer (SMR) combined with ASU unit to provide the nitrogen (see Figure 1).

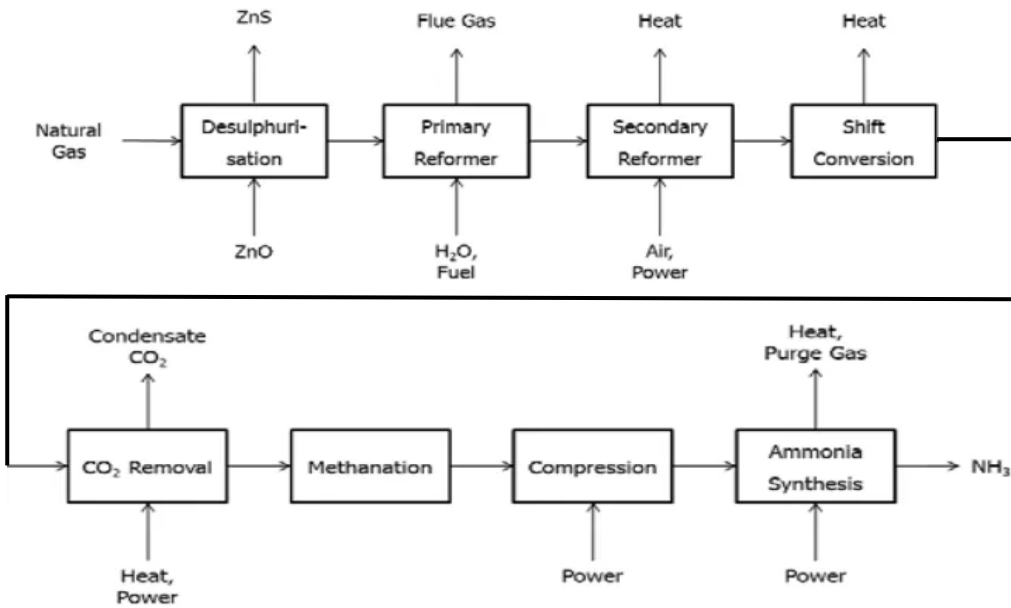

Figure 2: Conventional ammonia plant

2) Conventional – blue NH₃

A blue ammonia plant is a conventional NH₃ plant with carbon capture (CC) to capture the CO₂ emissions from the reformer. This will significantly reduce the carbon footprint compared to that of grey ammonia. The raw material is however still natural gas, and the plant layout is similar to that of a conventional plant.

3) Electrolysis – green NH₃

A green ammonia plant uses green hydrogen produced via electrolysis to feed the ammonia synthesis loop (see Figure 3). The electrolysis shall be powered with renewable energy such as wind power.

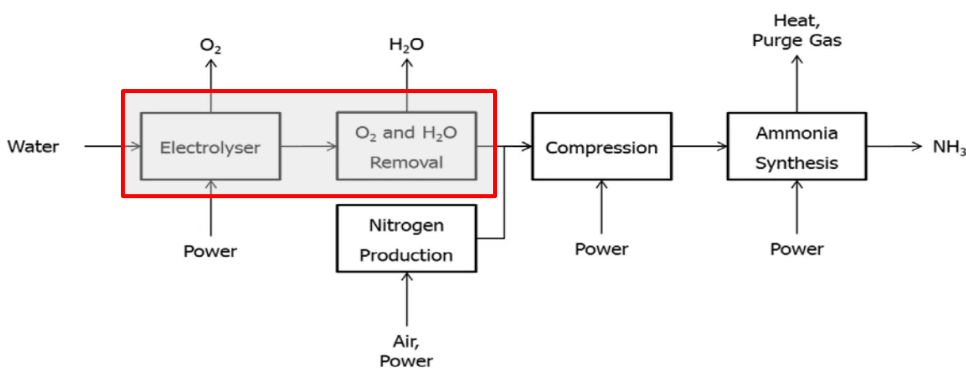

Figure 3: Green ammonia plant. Any impurities of O₂ in the H₂ product is removed by reacting it with H₂ over a DeOX (de-oxygenation unit).

4) Electrochemical synthesis of ammonia – green NH₃

Direct production of NH₃ by electrocatalytic reaction of water and air, i.e. eliminating the Haber-Bosch process, may become an alternative process for green NH₃ with use of renewable electricity. This technology is still only at research level (see further description below under 4) *Autothermal reforming (ATR)*).

Description of each process step

1) Feed purification (PUR)

The feed purification section removes impurities (sulphur, chlorine and heavy metals) that are poison to downstream catalyst.

The purification section typically consists of two reactors; The first one is a hydrogenator that converts organic sulphur (and chlorine) into H₂S (HCl) via the following reaction:

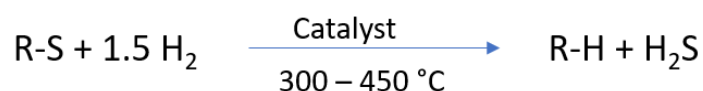

The second one is a downstream absorber that removes H₂S (and HCl) from the feed via absorption.

2) Steam methane reforming (SMR)

Steam methane reforming is a method for producing hydrogen from hydrocarbons and steam via the following reactions:

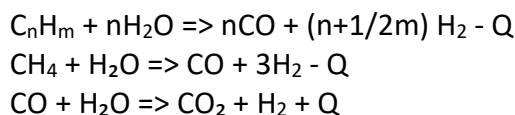

Typical outlet conditions	
Temp.	800-920 °C ⁷
Pres.	20-50 barg
CH ₄	5-10 dry %
CO	15-20 dry %
CO ₂	5 dry %
H ₂	70 dry %
N ₂ , Ar	< 1 dry %

The reforming reactions are highly endothermic, meaning that heat must be added. The SMR typically consists of several catalyst-filled tubes to which heat is added either via a fired radiation box or via convection with a >1000 °C hot flue gas. In both cases, fuel must be added to provide the heat. The temperature of the flue gas leaving the reformer depends on the technology applied but is in the 900-1150 °C range.

⁷ If followed by secondary reformer, the outlet temperature (T_{out}) is ~800°C, while it is ~900°C if there is no downstream reformer

3) Secondary reformer (2. REF)

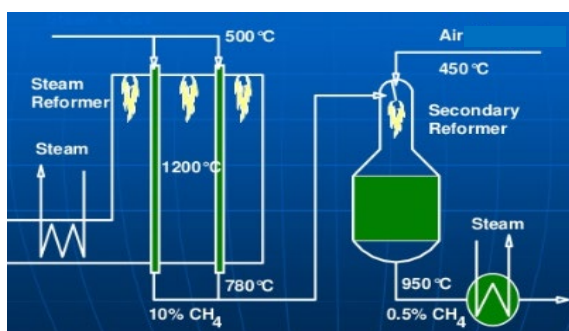

Figure 4: Primary and secondary reformer arrangement

Typical outlet conditions	
Temp.	900-1000 °C
Pres.	20-50 barg
CH ₄	<0.5 dry %
CO	10-15 dry %
CO ₂	5-10 dry %
H ₂	50-60 dry %
N ₂	20-25 dry %
Ar	<0.5 dry %

Nitrogen for the NH₃ production can either be added via an ASU or via an air-fired secondary reformer.

Within the secondary reformer, heat for the reforming process is provided by burning some of the syngas inside the reactor with admitted air. By adding air, N₂ is added, meaning that an ASU is not needed.

The reaction scheme is:

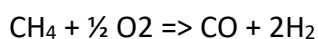

The addition of air is controlled such that the hydrogen to nitrogen ratio at the inlet to the ammonia loop is approximately 3:1, which is the required stoichiometric ratio for the ammonia reaction.

4) Autothermal reforming (ATR)

Typical outlet conditions	
Temp.	1000-1100 °C
Pres.	20-50 barg
CH ₄	< 0.5 dry %
CO	15 dry %
CO ₂	5-10 dry %
H ₂	50 dry %
N ₂	25 dry %
Ar	< 0.5 dry %

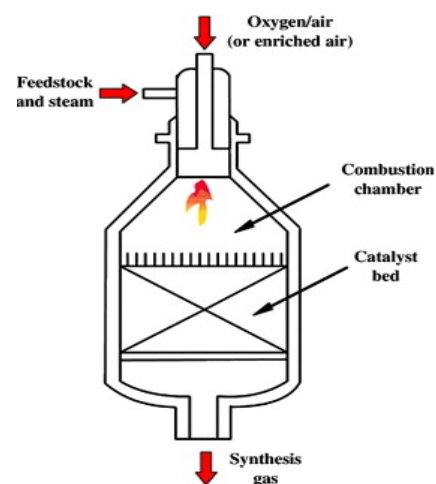
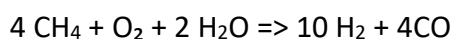
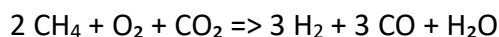

Figure 5: Autothermal reformer (ATR)

Like SMR, ATR can be used to convert hydrocarbon feed into a hydrogen rich syngas.

Within ATR, heat for the reforming reaction is provided by burning part of the syngas inside the reactor commonly with pure oxygen. This gives the following reaction scheme:



The advantage of ATR is that the product H:CO ratio can be varied, depending on the amount of steam and oxygen (O₂) added.

5) Water gas shift (WGS)

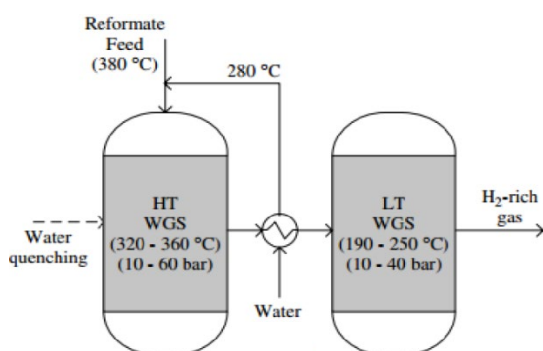
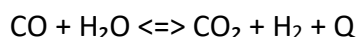

Figure 6: Typically shift configuration in an ammonia plant

Typical outlet conditions	
Temp.	~ 160 °C
Pres.	20-40 barg
CH ₄	<0.5 dry %
CO	<0.5 dry %
CO ₂	20 dry %
H ₂	60 dry %
N ₂	20 dry %
Ar	<0.5 dry %

The purpose of the shift reactor(s) is to produce additionally hydrogen (H₂) by converting CO via the following reaction:



As the shift reaction is exothermic, low temperature favors a low equilibrium content of CO. However, a low temperature also decreases the reaction rate.

To ensure fast conversion and at the same time low CO slip, the shift section can be a series of shift reactors with interstage cooling (see Figure 6). A conventional ammonia plant typically includes a high temperature shift (HTS) and a low temperature shift (LTS).

6) CO₂ removal unit (CO₂rem)

The CO₂ in the syngas from the WGS must be removed before the syngas is admitted to the NH₃ synthesis.

The reason is that CO₂ is poisonous to the NH₃ catalyst. Alternatively, all CO₂ could be converted to methane in downstream methanization reactor (see methanization step in next subsection), but this will create a huge amount of inert (CH₄ and Ar are inert in the ammonia loop) in the NH₃ loop that must be compressed and purged out.

Typical outlet conditions	
Temp.	~30 °C
Pres.	20-50 barg
CH ₄	<0.5 dry %
CO	<0.5 dry %
CO ₂	0.05 dry %
H ₂	75 dry %
N ₂	25 dry %
Ar	<0.5 dry %

The CO₂ removal unit is typically based on amine absorption technology. Other applied technologies are Selexol, Benfield and Vetrocoke.

7) Methanization (METH)

The methanization process aims to remove any residual CO and CO₂ (as they are poisonous to the ammonia catalyst) from the feed stream before it enters the ammonia synthesis reactor.

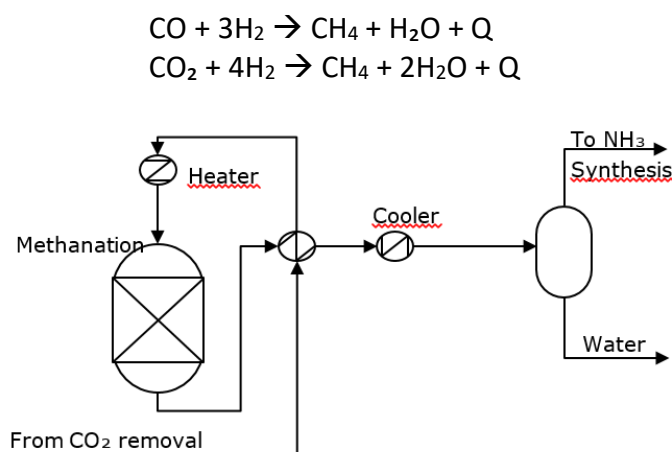

Typical outlet/syngas conditions	
Temp.	~30 °C
Pres.	20 – 50 barg
CH ₄	< 1 dry %
CO	< 5 ppm
CO ₂	< 5 dry ppm
H ₂	75 dry %
N ₂	25 dry %
Ar	< 0.5 dry %

Figure 7: Methanization, cooling and water separation

8) Ammonia Synthesis

The hydrogen and nitrogen feed stream are compressed and admitted to the ammonia loop (referred to as the Haber-Bosch process).



This ammonia reaction is highly exothermic, and the heat produced is used to generate steam. The steam generated is an export from the ammonia synthesis loop. In a conventional plant, some of the steam is used for hydrogen production in the steam methane reformer (SMR) and some for power generation in steam turbines.

The conversion rate is typically only ~25 % per single pass, so a large internal recycle is required to ensure high overall conversion.

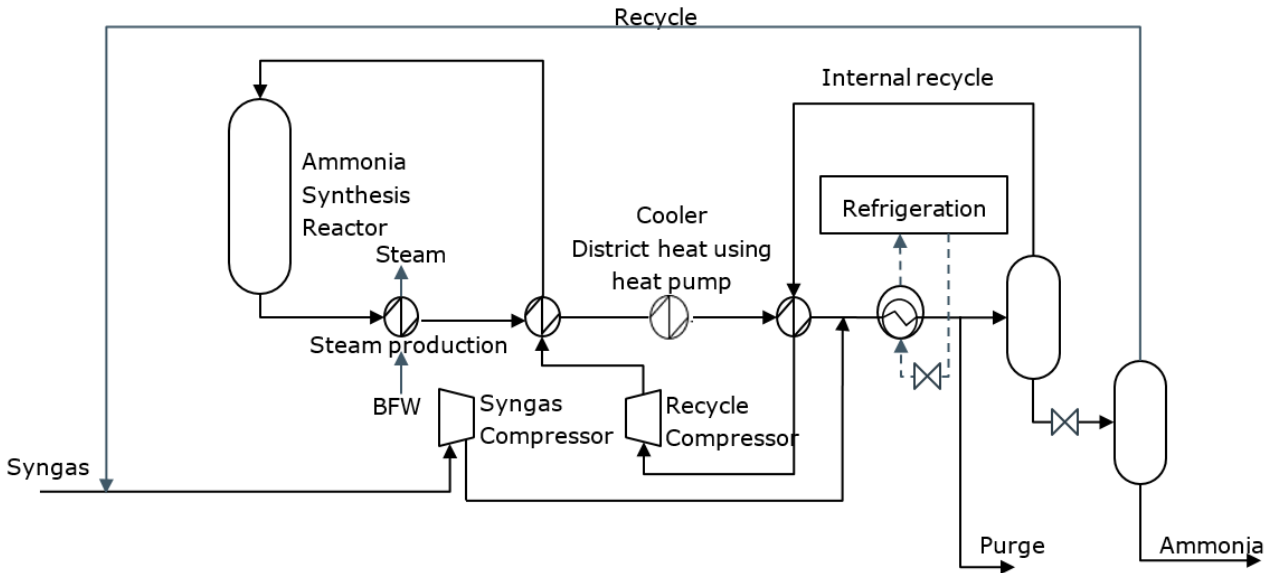

Figure 8: Ammonia synthesis loop and downstream purification

The ammonia synthesis benefits from a high operating pressure. Depending on the technology provider the loop usually runs at anything between 150 to 250 barg. A common overall loop pressure drop is approximately 10 bar. Temperatures in the loop range from 350°C to 550°C.

Typical ammonia product outlet conditions	
Temp. (°C)	-10 - 0
Pres. (barg)	20-25
NH ₃	> 99 %

The steam from the ammonia reactor is cooled, chilled and condensed. The condensed ammonia is separated from unreacted reactant first in a high-pressure vessel and then in a 20-25 barg vessel. The unreacted reactants are recycled back to the process.

9) Electrolysis

For electrolysis reference is made to the existing catalogue chapter [ref 4].

10) Air separation unit

Pure nitrogen is required as feedstock for the Haber-Bosch synthesis of ammonia, as shown in Figure 1. Pure nitrogen is produced by an ASU, which uses a cryogenic distillation process to separate ambient air into nitrogen, oxygen, and argon.

Figure 9 shows a flow-diagram for a typical ASU configured for nitrogen production. Ambient air is compressed and dehydrated before it is chilled by heat exchange with the cold liquid N₂/O₂ products from

distillation. Final chilling is obtained by expansion of the air. The distillation column will separate liquid nitrogen from liquid oxygen and argon. The ASU does not produce any usable heat.

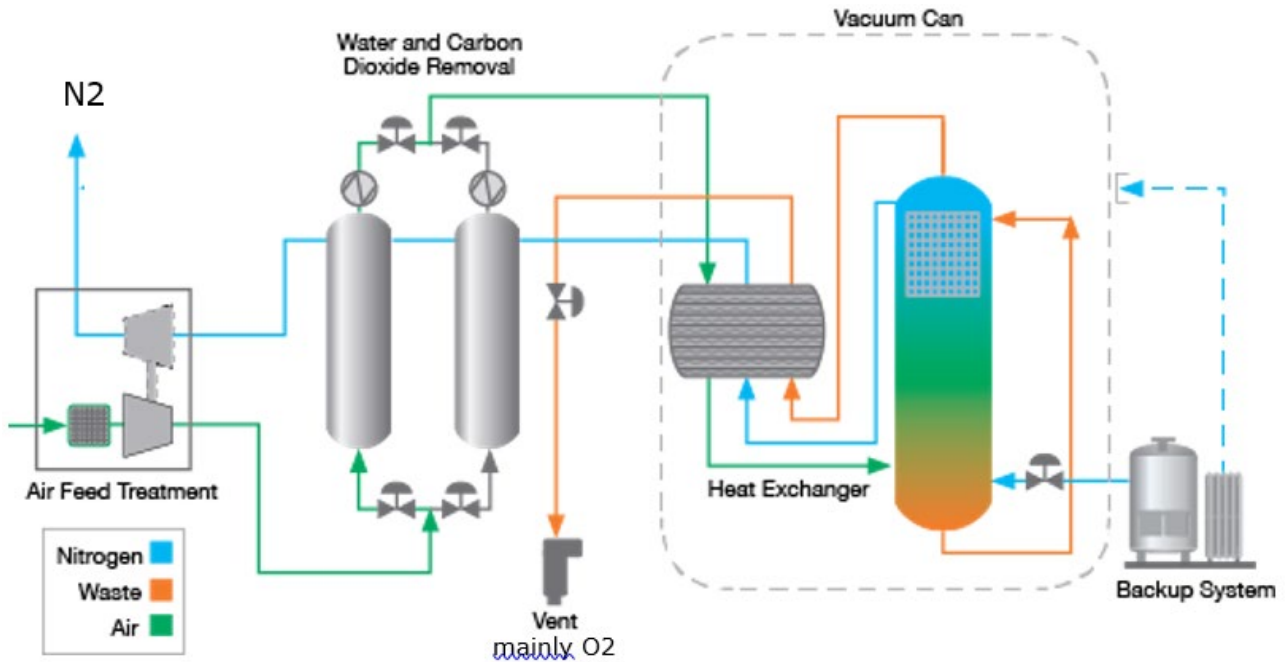

Figure 9 Schematic flow diagram of nitrogen plant. Source: AIChE

The ASU will deliver highly pure nitrogen (>99.9%), but can also be configured to coproduce pure oxygen, which may be used in the production of grey/blue hydrogen if the ammonia plant employs autothermal reforming (ATR).

11) Electrochemical synthesis of ammonia

Direct electrochemical synthesis of ammonia from N_2 /air and water by use of renewable electricity is an interesting alternative, as it avoids the Haber-Bosch process and potentially also the air separation. The electrochemical synthesis of ammonia is a process path that has been under development for the past 20 years and many different configurations are being examined.

Several studied paths exist. Some key paths are summarized in Figure 10.

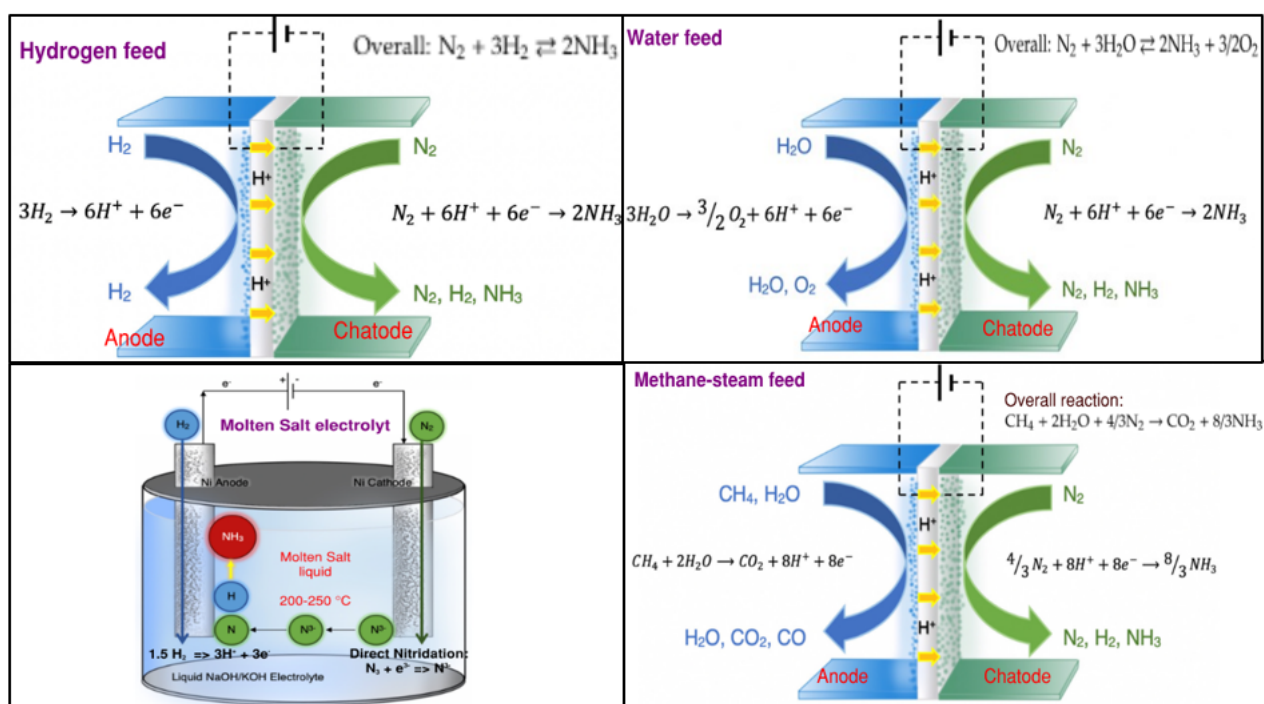

Figure 10. Illustration of the anode and cathode reactions during electrochemical NH_3 production. [1]

The different approaches to electrochemical ammonia production that have been studied can be divided into a low and high temperature path:

Low temperature path (<100°C): This is typically conducted in an aqueous cell, where the aqueous solution is both the hydrogen source and acts as the electrolyte. Different aqueous electrolyte solvent and different catalytic materials have been investigated (Fe_2O_3 , MOF (Au, Fe, Cu), Ni, etc.) to maximize efficiency and reaction rate. However, at low temperature only very low reaction rates have been achieved.

High temperature path (>100°C, typically 200-650°C): The high temperature path typically applies a solid-state electrolyte or a molten salt. The hydrogen source can be hydrogen itself, steam or methane-steam mixture. The main advantage of the high temperature path is that significantly higher reaction rates are achieved. However, the efficiency is lower. A major disadvantage with higher temperature is the competing hydrogen formation reaction and decomposition of the NH_3 product which start above 250°C and is dominating at 500°C [1].

Results indicate an inverse relationship between efficiency and reaction rate. Hence high temperature and the catalysts that provide the higher reaction rate tend to provide the lowest efficiency. The achieved reaction rates and efficiencies today are still far too low for practical application [1, 2], hence this process will be decades away from commercialization. The TRL is judged to be 1-2.

12) Combining electrolysis and ASU in SOEC

Power2Ammonia is a EUDP-funded project for production of ammonia synthesis gas in an SOEC core [Fejl! Henvisningskilde ikke fundet.].

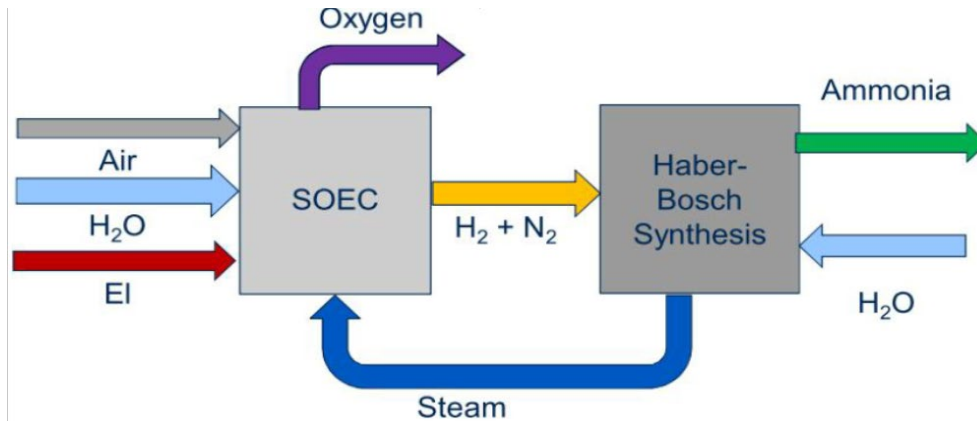

Figure 11: SOC4NH3 project combining electrolysis unit and ASU (EI = power)[ref 15]

Within the electrolysis, the component that is transported from the anode to the cathode is:

1. Alkaline electrolysis (AEC): OH^-
2. Polymer exchange membrane electrolysis (PEM): H^+
3. Solid oxide electrolysis (SOEC): O^{2-}

As the solid oxide transports O^{2-} , it might be used to separate O_2 from the air. Thus, the ASU can be eliminated. The EUDP project has demonstrated 50 kW operation, i.e. the TRL is low (4-6).

Operation range

The operation ranges of both conventional and green ammonia plants can be divided into:

1. Shut down – Cold standby
2. Hot standby – no production but plant is kept warm for fast startup
3. 0-20 % operation
4. 20-35 % operation
5. 30-100 % operation

1) Shut down – cold standby

Shut down/cold standby is when the plant is shut down and cooled to ambient temperature.

Cold shut down should generally only be used for maintenance. It should not be used for a short stop of the plant due to no product demand or missing feed availability. The reason is that frequent cooling and reheat will cause catalyst crunching (due to grinding among catalyst particles caused by expansion upon heating and shrinking upon cooling) and thereby reduced catalyst lifetime. Therefore, an ammonia plant must be kept in hot standby mode (see next section) in periods, in which it is not in operation.

2) Hot standby mode

Hot standby mode is an operation mode where there is no production but almost all units are kept at normal operation condition (i.e. at normal operation temperature and pressure) to enable a fast ramp up in capacity.

For an ammonia plant, the hot standby mode depends on the duration, i.e. it may be still-standing for a couple of days, while circulating hot gas may be used to keep the reactor warm for prolonged periods (weeks). Starting an ammonia loop from cold conditions can take up to one day, while ramping up from hot conditions is usually ~2 hours. Hot standby mode requires no feedstock. The energy that needs to be added during prolonged hot standby will be equal to heat loss to the surroundings, which will be very little if the plant is properly insulated. For start-up, a start-up heating system is needed anyhow, so the additional capital investment for facilitating a hot stand-by mode will be very minor.

Similar, for an electrolysis unit, a hot standby mode can enable fast ramp up (within seconds)⁸. Depending on weather forecast and knowledge about fluctuations in electricity generation and demand, the number of electrolysis cells that is kept in hot standby mode can be optimized.

3) Operation at 30 – 100% Capacity

A conventional ammonia plant usually has an operating capacity of 70-100%. However, as general turndown ratio of rotating equipment, many transmitters and control valves are 30%, these plants can normally handle loads down to 30% without mayor changes.

4) Operation at 20 – 35% Capacity

If there is a need to reduce operations to 20%, this can usually be achieved by additional CAPEX spending to buy equipment that can handle larger capacity ranges.

5) Operation at 0 – 20% Capacity

For operation at lower capacity than 20% a significant increase in CAPEX can be expected, as multiple valves, instruments and rotating equipment would have to be purchased to manage the wide range of operating loads.

Demand for operation flexibility

The requirements for operation flexibility depend strongly on the feed availability (power or hydrogen) and on requirements for product flow.

If the feed is hydrogen, i.e. the plant is connected to a hydrogen transmission net, the buffer within the hydrogen transmission net will ensure a stable feed flow, which cost is fairly stable. Thus, the demand for the operation flexibility will be low.

⁸ Typical power connection requirement is: 50% ramp in power supply within <5s and 100% ramp in power supply within 30s (if a connection can guarantee this connection requirement, a higher price is given)

Alternatively, if the feed is power, i.e. hydrogen is produced by electrolysis of water, fluctuating power prices and the wish to maximize earning naturally imposes some desire for high flexibility in the capacity of the ammonia plant.

Regarding fluctuating power prices, the following scenarios must be considered:

- A. Fast ramping: Grid connections that facilitate fast ramping cost less. The electrolysis unit is able to provide FCR⁹ (West Denmark) and FCR-D (East Denmark) connection
- B. Prolonged periods with high power prices

Point A: The ammonia synthesis cannot ramp as fast as the electrolysis unit. However, minor "hydrogen + nitrogen" storage can ensure that a green ammonia plant can fulfill point A.

Point B: As discussed in subsection **Fejl! Henvisningskilde ikke fundet.**, it is crucial that the temperature within the ammonia reactor is kept constant as frequent cooling and reheat will cause crunching, whereby the catalyst lifetime is reduced. To maximize earnings under prolonged periods with high power prices and at the same time ensure a constant temperature in the ammonia reactor, the following design options (or a combination of them) can be applied:

1. Design NH₃ plant with large operation range + additional NH₃ storage:
Periods with high price of power can be optimized by ramping down the capacity of the NH₃ plant and even put it into a hot standby mode. This can be combined with additional NH₃ storage¹⁰ to fulfill any contractual requirement on a minimum ammonia production rate.
2. Locate next to a hydrogen transmission net:
As stated above this will minimize fluctuating feed cost.
3. Hybrid NH₃ plant:
Combining the green NH₃ production with existing conventional NH₃ production will make it possible to ramp up the load of the reforming section when the power prices are high.

The most optimal option depends on the circumstances. The location next to a hydrogen transmission net or next to an existing conventional ammonia plant are likely to be the most cost-efficient solutions. The disadvantage of point 1 (and to some extent also to point 3) is that the huge capital cost of an ammonia plant normally requires >90% load to pay back the capital expenses.

Properties of ammonia

Thermal and physical properties of gaseous ammonia:

⁹ FCR=Frequency containment reserves,

FRD =Ramp 100% within less than 30s (west DK).

FCR-D =Ramp 50% within 5s and 100% within 30s (east DK).

¹⁰ Note: NH₃ storage is much cheaper than H₂ storage

Molecular weight	17 kg/kmol
Normal density	0.77 kg/m ³
Lower heating value, LHV	19 MJ/kg
Higher heating value, HHV	23 MJ/kg

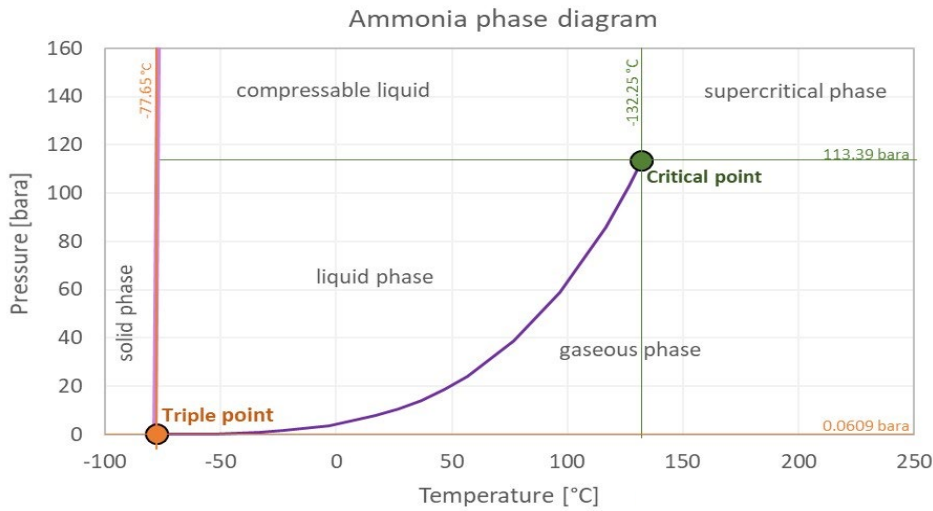

Mass and energy balance

This section gives an overview of inputs and outputs of an ammonia synthesis in energy (e.g. MWh).

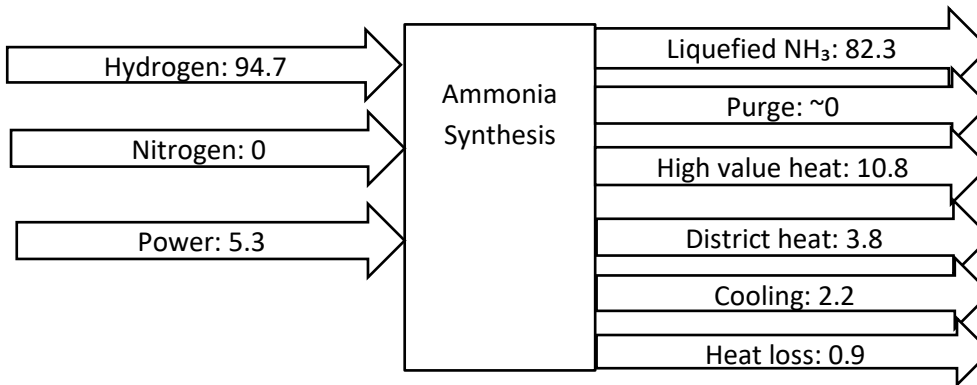

Figure 12: Overall energy balance of the ammonia synthesis. The electrolysis unit is covered in [4] and power required for the ASU is listed in Table 1.

Input

The input to the ammonia synthesis loop is hydrogen, nitrogen and power as per Figure 12.

Including the electrolysis unit and the air separation unit (ASU), the input streams are water, air and power.

Boiler feed water (BFW) is normally used to extract the high value residual heat from the ammonia synthesis reaction, while cooling water is used to remove the low calorie residual heat (see Figure 8).

Output

The output streams from the ammonia synthesis is ammonia, steam, hot water (district heating water) and a tiny purge stream.

The high value heat can be used to make steam at different levels. The steam can be converted to high pressure steam and used within the plant to drive the compressors. The steam that is not used to power the process can be exported.

The purge is needed to remove any accumulated impurities, but as the feed stream is almost 100% pure H_2 and N_2 , the purge will be insignificant. As the purge contain impurities of NH_3 , it must be burned off as a fuel or sent to a flare.

Including electrolysis unit and ASU, the overall output streams are, besides the above mentioned, oxygen from the electrolysis unit and oxygen from the ASU.

Energy balance

The energy balance of the ammonia synthesis is given in Figure 12.

Energy balance of green ammonia plants including electrolysis unit and ASU: Many theoretical papers and studies have looked into the energy requirements of green ammonia plants. These vary greatly compared to a conventional ammonia plant, as the power consumption of the electrolysis unit makes up a large majority of the overall plant power requirements. Figure 13 Figure 13: Power requirement breakdown for a green ammonia plantshows an example of the energy balance breakdown of a green ammonia plant (operating at 150 bar), where the synthesis loop is the power required to drive compressors and pumps.

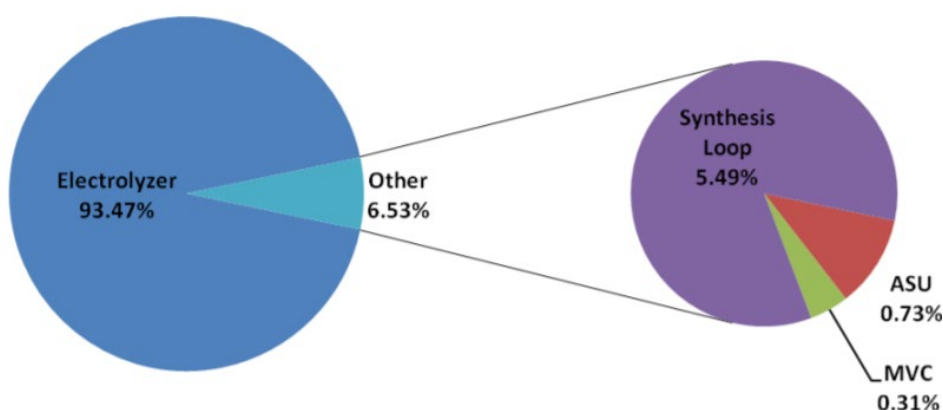

Figure 13: Power requirement breakdown for a green ammonia plant (MVC=Mechanical Vapor Compression, includes pumping and desalination of feed water to electrolysis unit) [ref 7].

Based on the authors' estimate the following energy consumption breakdown was found (the MVC above has not been included as it is minor):

Plant area	Power consumption	%
ASU	250 kWh/t N ₂	2.1%
Electrolysis unit (65% eff.)	9350 kWh/t NH ₃	94.4%
Syngas & Make up compressor	290 kWh/t NH ₃	2.9%
Ammonia refrigeration	50 kWh/t NH ₃	0.5%
TOTAL	9900 kWh/t NH₃ (36 GJ/t NH₃)	

Table 1: Major power consumption units in green ammonia plant (within the sum the power in ASU is converted to power per NH₃ instead of power per N₂ – see calculation in the subsection *Datasheets*)

The energy consumption of ASU's (200-400 kWh/ton N₂) depends on capacity, extent of integration, and whether a high share of liquid N₂ for back-up should be produced.

Integration possibilities

Integrations within conventional NH₃ plants are:

1. Steam produced in ammonia loop is normally used for:
 - 1.1. Steam addition to the steam methane reforming process
 - 1.2. Power production for the compressors and the pumps in the ammonia plant
 - 1.3. Export of steam
2. Recovered hydrogen in ammonia recovery unit (NH₃rec):
 - 2.1. Is used as hydrogen required for hydrogenation within the feed purification section
3. Recovered fuel gas (i.e. off-gas) from ammonia recovery unit (NH₃rec):
 - 3.1. Use as fuel for the steam methane reformer (SMR)
 - 3.2. If no steam methane reformer (SMR), normally exported

Integration possibilities within green NH₃ plants are:

1. Steam produced in ammonia loop can be used for:
 - 1.1. Electrolysis: In case of SOEC (future option), which operates at 700-900 °C, steam can be used as water for the electrolysis unit
 - 1.2. Power production for own consumption e.g. ASU, compressors and pumps in the ammonia plant
 - 1.3. Export of steam (for use in nearby industrial processes)
2. Oxygen from the electrolysis unit and the ASU:
 - 2.1. Export
3. Excess low-temperature heat
 - 3.1. Water/air coolers in electrolysis and ammonia loop can be used for district heating especially if combined with a heat pump

Hybrid NH₃ plant:

If ammonia is becoming a transportation fuel (which is most likely the case), then the ammonia market will increase substantially. Thus, there will be an interest in increasing the capacity of existing ammonia plants and/or make them greener, which both can be accomplished by adding an electrolysis unit to the existing plant. Whether the secondary reformer can cope with the increased N₂ demand or an ASU needs to be added, will depend on the demand for increased capacity.

If the purpose of adding an electrolysis unit is to increase the capacity, it will normally be done by identifying the bottlenecks of the existing ammonia plant and replace the units (or add additional units) that inherit the bottlenecks. The capacity can usually be increased to 110% capacity with no or very minor changes. Increasing the capacity with 20-30 % can often be done with acceptable investments (as only few equipment needs to be revamped/replaced), while larger capacity increase will require major investments as almost all items need to be replaced.

If the conventionally grey reforming section and the new green "ASU and electrolysis unit" section should be able to operate independently, i.e. without the other in operation, major integrations are not possible. Independent operation will be used if "ASU and electrolysis unit" is shut down when the power prices are high.

Integration possibilities within hybrid NH₃ plants:

1. Steam produced in ammonia loop can be used for:
 - 1.1. Steam addition to the steam methane reforming process
 - 1.2. Electrolysis: In case of SOEC (future option), which operates at 700-900 °C, steam can be used as water for electrolysis unit
 - 1.3. Power production for own consumption e.g. ASU, compressors and pumps in the ammonia plant
 - 1.4. Export of steam
2. Oxygen from the electrolysis unit and the ASU:
 - 2.1. Feeding the secondary reformer with enriched air: The capacity of the secondary reformer can be increased by feeding it with enriched air, as extra feeding duty (via partial combustion of feed gas with oxygen) can be obtained without having to add excess nitrogen [ref 9]
 - 2.2. Export
3. Hydrogen and off-gas from the NH₃rec units: Same as under conventional NH₃ plant
4. Excess low-temperature heat
 - 4.1. Water/air coolers in electrolysis and ammonia loop can be used for district heating especially if combined with a heat-pump
 - 4.2. Heat from electrolysis unit can be used for pre-heating of NH₃ recycle

A key feature of the electrolysis unit is that it can provide hydrogen for start-up. The feed purification section needs hydrogen, which is recycled from the downstream system, but as the downstream system is not in operation when starting the plant, imported H₂ is needed for conventional plants. This will not be the case for green or hybrid plants.

Typical capacities

The typical capacity of conventional ammonia plants erected today is in the range of 1000 to 3500 TPD of ammonia for a single line.

For green ammonia production, the size of the electrolysis unit or the available renewable electricity will set the limit for how large the units can be.

Design issues

Regulation ability

For plants based on intermittent renewable energy, one (or a combination) of the following options must be selected

1. A turndown ratio of 0% (hot standby mode)
2. Possibility to use grid power
3. Possibility to take feeds (N₂ and H₂) from grid or storage
4. Possibility to increase capacity of a conventional front-end (hybrid solution)

Several technology providers have quoted the following figures for turndown.

Haldor Topsoe:	10-100% (ref. 6)
ThyssenKrupp:	30-100% (vendor info)
Casale:	20-110% (vendor info)
KBR:	30-100% (vendor info)

Space requirement

Looking at conventional ammonia plants the plot space required for a production capacity of 1390 TPD is around 150 x 100 m. This includes all operation buildings but not storage facilities. The actual placement of processing areas within the plant is not critical, as long as industry safety rules are followed.

A typical ammonia plant (with secondary reformer and no ASU) may have the following layout:

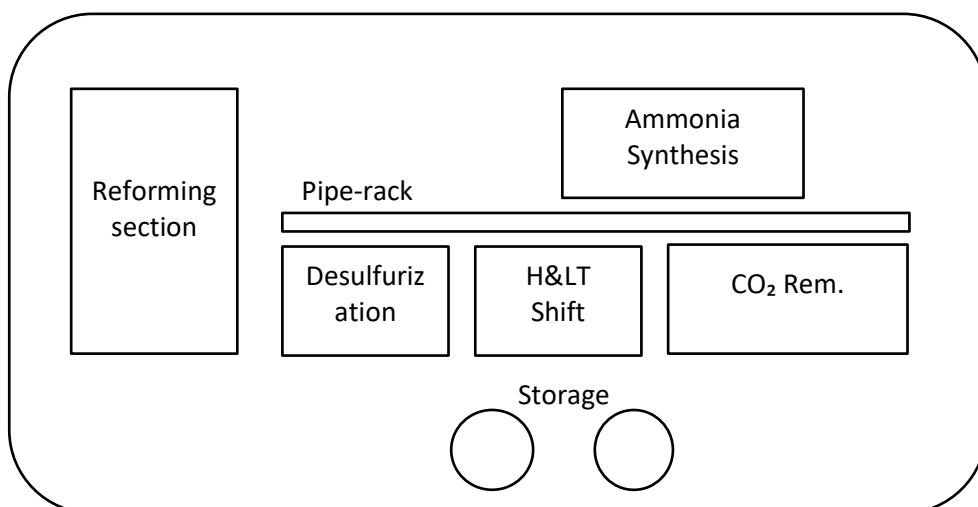

Figure 14: Typical ammonia plant layout

For a green ammonia plant, only the ammonia synthesis section of the plant is relevant, with the other areas removed to make space for electrolysis unit and ASU. The electrolysis unit and the ASU require less plot space than the reformer, desulfurization, shift reactors and CO₂ removal unit. Qualitatively speaking a green ammonia plant would require a smaller plot area than a conventional one for the same capacity.

Advantages/disadvantages

The main advantages of green ammonia production relative to conventional ammonia are:

- No fossil fuel (natural gas) is required, hence production can be made CO₂ emission free
- Location is not bound to areas/regions where inexpensive natural gas is available
- N₂ and H₂ feedstocks are pure, which reduce purging requirement and need for NH₃ recovery section. This increases the overall efficiency of the NH₃-synthesis (Figure 1)
- Capacity variation can contribute to an increased flexibility in power consumption, i.e. if power production is high, power utilization can be increased. This will increase the average utilization factor (load factor) of the renewable power production units

The main disadvantages can be summarized as:

- Fluctuations in renewable power generation leading to fluctuations in the operating profile will reduce the average utilization factor (load factor).
- Today the cost of hydrogen produced via electric power is significantly higher than that of natural gas, which gives higher costs of green NH₃.

Safety and environment

Key HSE (Health, Safety and Environment) concerns to consider in an ammonia plant are:

1. Ammonia: Is a toxic component – see description in ref 3
2. Hydrogen: Is a highly flammable and explosive component – see description in ref 3
3. Leakage
4. High pressure equipment
5. Chilling unit
6. Hot surfaces

Research and development perspectives

The Haber-Bosch process for ammonia synthesis is a mature process that has been in use in the industry for 100 years. The process has undergone significant improvements over the years, hence it is believed that future improvements and cost reductions will be marginal.

It is expected that the electrolysis technology for H₂ production will improve substantially towards 2050. In a ten-year timeframe it is expected that H₂ can be delivered at high pressure directly from the electrolysis unit. This will lead to reduction of CAPEX and electricity consumption for feedstock compression to green ammonia synthesis.

Successful combining electrolysis unit and ASU in an SOEC or successful development of the electrochemical process for low temperature production of ammonia from air and water may be potential game changers. However, as mentioned in the section describing the process step of the *Air separation unit*, the processes are far away from commercial application today.

Examples of market standard technology

Only few NH₃ plants with electrolysis units are operational today.

One plant is the Pilot plant in Minnesota (operation since 2013) which output is 25 ton/year green ammonia. The electrolysis unit is powered by wind [11].

Yara is developing a hybrid solution at their Pilbara ammonia plant in Western Australia. The plan is to erect a 100 MW solar farm to drive a 50-60 MW electrolysis unit, which will increase the production of ammonia from the existing Haber-Bosch unit with ~80 TPD [12]. The engineering for the tie-in of green hydrogen was completed in 2018 and expected date to come online is 2021. It is planned that the plant will expand its green ammonia production in stages up until 2030 when an expected 90% of its production will come from green sources.

Yara are also partnering with Orsted to develop a 100 MW electrolysis plant to produce green hydrogen for ammonia production in Holland. This is expected to be operational in 2024/2025 and will produce approximately 200 TPD of green ammonia [13].

Air Products have recently announced investment in a new green ammonia facility to be operational by 2025 at the industrial hub of NEOM in Saudi Arabian. Using Haldor Topsoe technology, the 4 GW plant will produce 650 TPD of green hydrogen, an equivalent of 3250 TPD of green ammonia [14].

In Denmark, near Lemvig, a new green ammonia plant is planned to start operating in 2022 producing 5000 ton/year green ammonia. The project is a collaboration between Skovgaard Invest, Haldor Topsøe and Vestas [16].

Prediction of performance and costs

Investment cost (CAPEX)

Predictions of investment costs for green ammonia plants are based on data from the industry as a whole, as no large-scale plants or projects have been completed or are in operation yet.

Overall plant cost data has been broken down into major plant section to get a distribution of cost. Several different sources have been compared and values for each section of the plant have been determined from this.

For the investment cost analysis, the following sections of the ammonia plant are included:

- Ammonia synthesis
- Balance of plant (BOP)¹¹
- Storage

Based on cost split data for various conventional plants (one example from Linde is seen in Figure 15) and figures obtained from various vendors, average split factors have been estimated. This approach gives that the average cost of the ammonia synthesis including storage and BOP is around ~54% of that of the cost of conventional NH₃.

¹¹ Balance of plant (BOP): BOP typically is surrounding utility, storage, startup and shut down facility. There is often variation in what BOP includes. Here storage and electric plant is listed separately, meaning they are not included in the BOP.

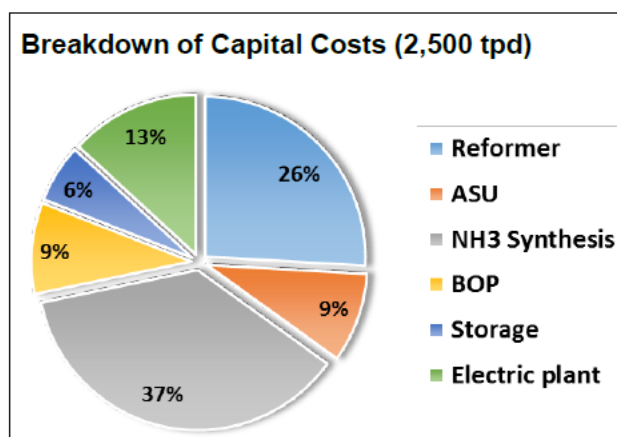

Figure 15. Cost split on main systems in a conventional NH₃ plant from Linde [10]. Reformer, electric plant (power plant) and some balance of plants (BOP) will disappear for a green NH₃ plant. Cost of green NH₃ plant (excl. electrolysis unit and ASU) is therefore taken as 54% of conventional plant, based on all obtained data.

In Figure 16 a cost-capacity curve for specific CAPEX of green ammonia plant (k€/TPD) has been derived using cost data of conventional ammonia plants at different capacities. The 0.54 factor explained above has been used to remove ASU and scope not relevant for green ammonia. All costs in the figure have been scaled using the Chemical Engineering Plant Cost Index (CEPCI) to reflect 2019 costs.

It is observed that at low capacities (<300 TPD) there is a steep increase in the specific CAPEX. As the design hours, construction time and the amount of metal used per unit capacity is much larger for small plants than for large plants, customized small plants will always be much more expensive than large plants. However, skit-mounting and mass production can change this picture substantially, i.e. the steep increase for small capacities shown in Figure 16 may decrease substantially if a market for small ammonia plant comes forward. But it is questionable whether a larger market for small ammonia plants will develop, as the advantages of having distributed ammonia plants is limited.

In order to add the cost of the ASU, a multiplication factor of 1.06-1.09 must be added to the total cost of the ammonia plant sections as listed above.

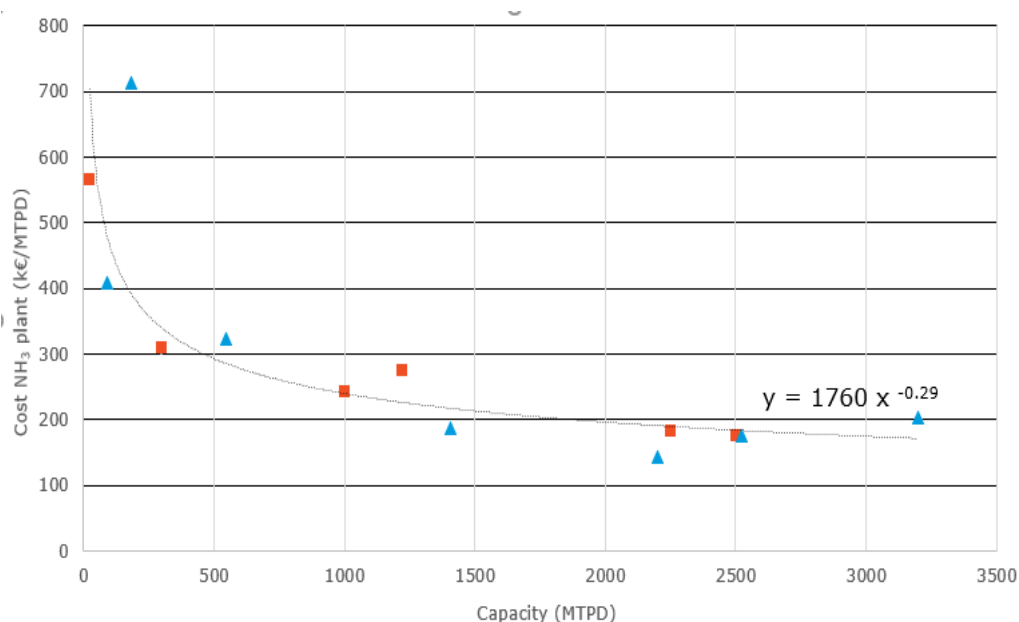

Figure 16: Estimated cost of ammonia synthesis + BOP + Storage (electrolysis unit and ASU is not included in the figure). Blue triangles represent data that is publicly available. All figures adjusted to reflect cost index for 2019.

Variable and Fixed O&M costs

Fixed operating and maintenance costs are taken as 3% of CAPEX.

Variable operating and maintenance costs are taken as costs of catalyst replacement and other minor consumables. Catalyst replacement is scaled based on a reference for a 1500 TPD NH₃ plant with 10 m³/year [5]. Iron catalyst price is assumed to be 3000 EUR/m³.

Uncertainty

With respect to small NH₃ plants (< 500 TPD) there is high uncertainty as few plants are built in this size range today (the data from the small plants in Figure 16 is vendor-estimated values and not values from actual constructed plants). For larger NH₃ plants, there are many references, hence the uncertainty is somewhat lower.

In addition, CAPEX will depend a lot on location and local conditions.

Datasheet

The datasheet has been produced for a 229 TPD green ammonia plant, which is equivalent of a plant using electrolysis units of a total of ~90 MW.

Figures for capacities increasing up to 2290 TPD (~900 MW electrolysis unit) are included to give a reference of potential future gigaplants.

In Figure 17 below, a mass and energy balance example is given including electrolysis unit and ASU. The example has been adjusted so it matches the number in Figure 12. Calculating back, 146 MW electrolysis is needed to give 94.7 MW H₂ that is fed to the ammonia loop producing 82.3 MW liquefied NH₃. The power

needed for the ASU is 3.3 MW and the power needed for the compressors in the ammonia loop is 5.3 MW giving a total power consumption of 155 MW.

Ammonia									
Electrolysis:									
Capacity, MW	146								
Efficiency (LHV basis),%	65								
Ammonia loop:									
H2 eff. in NH ₃ loop, %	98								
	F	MW	FM	FM	Q	Frac.			MWh
	Nm ³ /h	kg/kmole	kg/h	TPD	MW	t/tNH ₃			MWh(in)
H ₂	31581	2.02	2840	68	94.7	0.18			0.95
N ₂	10527	28.0	13157	316	0	0.84			0.00
NH ₃	20633	17.0	15677	376	82.3				0.82
					kWh/tX	kWh/h	MW	%	
ASU power (X=N ₂)					250	3289	3.3	2.1	
Electrolysis (X=NH ₃)					9350	146581	147	94.4	
Syngas and makeup compressor (X=NH ₃)					290	4546	4.5	2.9	0.05
Ammonia refrigeration (X=NH ₃)					50	784	0.8	0.5	0.01
Total					9900	155200	155	100	
Power to ammonia loop							5.3		0.05
Energy input to NH ₃ loop (H ₂ + power)							100		
High value heat							10.8		0.11
District heat							3.8		0.04
Cooling							2.2		0.02
Energy output from NH ₃ loop (LNH ₃ + heat + cooling)							99.1		

Ammonia									
Electrolysis:									
Capacity, MW	88								
Efficiency (LHV basis),%	65								
Ammonia loop:									
H2 eff. in NH ₃ loop, %	98								
	F	MW	FM	FM	Q	Frac.			MWh
	Nm ³ /h	kg/kmole	kg/h	TPD	MW	t/tNH ₃			MWh(in)
H ₂	19186	2.02	1726	41	57.5	0.18			0.95
N ₂	6395	28.0	7993	192	0	0.84			0.00
NH ₃	12535	17.0	9524	229	50.0				0.82
					kWh/tX	kWh/h	MW	%	
ASU power (X=N ₂)					250	1998	2.0	2.1	
Electrolysis (X=NH ₃)					9350	89048	89	94.4	
Syngas and makeup compressor (X=NH ₃)					290	2762	2.8	2.9	0.05
Ammonia refrigeration (X=NH ₃)					50	476	0.5	0.5	0.01
Total					9900	94284	94	100	
Power to ammonia loop							3.2		0.05
Energy input to NH ₃ loop (H ₂ + power)							61		
High value heat							6.6		0.11
District heat							2.3		0.04
Cooling							1.3		0.02
Energy output from NH ₃ loop (LNH ₃ + heat + cooling)							60.2		

Figure 17: Calculation example including electrolysis unit and ASU. Example to the left is adjusted such that the energy input to the ammonia synthesis sums up to 100 MW (blue value) producing the values given in Figure 12 (green values). The figure to the right is adjusted so it produces 50 MW NH₃, producing the values for 2020 in the datasheets (red values).

Note to use cost data in the datasheet

The cost development exclusively reflects effects from economy of scale and no further technological development is expected (see Figure 16). Cost estimation of future gigaplants will also apply for earlier years. In case a gigaplant of e.g. 2290 TPD is expected for 2040 already instead of 2050, one should use the expected cost values for this plant size of 0.8 M€/MW, instead of the cost data for the given year.

Technology	Green Ammonia plant: Hydrogen to ammonia (excl. electrolyzer and excl. ASU)									
	2020	2030	2040	2050	Uncertainty (2020)		Uncertainty (2050)		Note	Ref
					Lower	Upper	Lower	Upper		
Energy/technical data										
Typical total plant size, TPD	229	458	916	2290	100%	100%	100%	100%	A	
Typical total plant size, MW (Ammonia output)	50	100	200	500	100%	100%	100%	100%		
Inputs										
N2 Consumption, t/t Ammonia	0.84	0.84	0.84	0.84	98%	102%	98%	102%	B	[1]
Hydrogen Consumption, t/t Ammonia	0.18	0.18	0.18	0.18	98%	102%	98%	102%	B	[1]
Hydrogen Consumption, MWh/MWh Total Inputs	0.95	0.95	0.95	0.95	98%	102%	98%	102%	B	[1]
Electricity Consumption, MWh/MWh Total Inputs	0.05	0.05	0.05	0.05	95%	110%	75%	150%	C	[1]
Outputs										
Ammonia Output, MWh/MWh total Input	0.82	0.82	0.82	0.82	98%	102%	98%	102%		[1]
High value heat MWh/MWh total input	0.11	0.11	0.11	0.11	98%	102%	98%	102%	D	[1]
District Heating Output, MWh/MWh Total input	0.04	0.04	0.04	0.04	0%	100%	0%	100%	E	[1]
Operational data										
Forced outage (%), unplanned shutdown	5%	3%	3%	2%	2%	8%	2%	4%		[3]
Planned outage (weeks per year)	3%	3%	3%	3%						[3]
Operation capacity	20-100%	20-100%	20-100%	20-100%						[2]
Technical lifetime (years)	30	30	30	30						
Construction time (years)	2	2	2	2						
Financial data										
Specific investment (M€ /MW Ammonia output)	1.6	1.3	1.1	0.8	1.3	2.2	0.6	1.0	F, I, J	[3]
- equipment (%)	50	50	50	50						[3]
-installation (%)	50	50	50	50						[3]
Fixed O&M (k€/MW Ammonia/year)	48	39	32	24	39	66	18	30	G	[3]
Variable O&M (€/MWh Ammonia)	0.02	0.02	0.02	0.02	0.01	0.04	0.01	0.04	H	[3]
Start up (M€ /1,000 t Ammonia)	N.A.	N.A.	N.A.	N.A.						
Technology specific data										
Specific investment mark-up factor optional ASU	1.09	1.09	1.09	1.09	97%	100%	97%	100%	F	[3]
Specific energy content (GJ/ton Ammonia)	18.9	18.9	18.9	18.9						
Specific density (kg/l) or (ton/m3) Ammonia	626	626	626	626						
Specific investment (M€ /TPD Ammonia output)	0.35	0.28	0.23	0.18	0.3	0.5	0.13	0.2	F, I	[3]
Fixed O&M (M€ /TPD Ammonia)	10.4	8.5	7.0	5.3	8.5	14.4	3.9	6.6		[3]
Variable O&M (€ /t Ammonia)	0.10	0.10	0.10	0.10	0.05	0.20	0.05	0.20		[3]
Start up (M€ /TPD Ammonia)	N.A.	N.A.	N.A.	N.A.						

Notes:

- A: Typical NH₃ plant size based on H₂ supply from 100 MWe electrolyzer for 2020.
- B: Assume 98% efficiency with respect to mass of the ammonia synthesis
- C: Assumption of higher pressure electrolysis available in the future, requiring lower compression power. A green ammonia plant that contains a dedicated ASU for nitrogen production will have additional power requirements, cf. chapter 3.3
- D: Steam at up to 350°C may be produced by NH₃ synthesis
- E: Heat available at 30-60°C and requires heat pump for use for district heating.
- F: Specific investment of green NH₃ plant (excl. electrolysis, excl. ASU, NH₃ storage and utilities) is estimated as 54% of conventional NH₃ plant based on NG. Cost is decreasing with time mainly because of scale effect (increasing plant size). To add the cost of an ASU a multiplication factor of 1.06-1.09 should be applied to the total Specific Investment (both entries in Financial Data and Technology-specific data) as a rule of thumb.
- G: Fixed O&M is taken as 3% of CAPEX
- H: Variable O&M estimated as cost for catalyst replacement and misc. consumables
- I: Financial data is given in 2015-€ as in the other datasheets (and in contrast to Figure 9-2, which is showing the corresponding cost in 2019-€)
- J: Cost projection is considering economy of scale only and does not consider further technical development, due to the maturity of ammonia synthesis. In case capacities are expected for other years than shown in the datasheet, one should use the corresponding cost data of the respective capacity instead of the cost data for a given year. See also Figure 16 in the chapter.

References

1. I. Garagounis, A. Vourros, D. Stoukides, D. Dasopoulos, M. Stoukides. Electrochemical Synthesis of Ammonia: Recent Efforts and Future Outlook. *Membranes*, 2019 Sep; 9(9): 112
2. Runbo Zhao et al. Recent progress in the electrochemical ammonia synthesis under ambient conditions, *EnergyChem* 1, 100011 (2019).
3. Technologikatalog kapitel om transport og mellemlagring af brint, ammoniak, DME og LOHC – Energistyrelsen
4. Technology data for renewable fuels – Energistyrelsen 2018
5. Eric R. Morgan, *Techno-Economic Feasibility Study of Ammonia Plants Powered by Offshore Wind*. University of Massachusetts Amherst. Open Access Dissertations. 697.
6. Ammonfuel – An industrial view of ammonia as a marine fuel; Topsoe, Alfa Laval, Hafia, Vestas, Siemens Gamesa; 2020
7. https://scholarworks.umass.edu/cgi/viewcontent.cgi?article=1704&context=open_access_dissertations
8. <https://nh3fuel.files.wordpress.com/2014/10/nh3fa-2014-joel-tallaksen.pdf>
9. <https://www.process-worldwide.com/how-to-increase-ammonia-plant-capacity-a-398571/?p=3>
10. D.D. Papadias, J-K. Peng, R.K. Ahluwalia. H₂ at Scale: Outlook of Hydrogen Carriers at Different Scales. DOE Hydrogen Carriers Workshop, Denver, Nov 13-14, 2019.
11. <https://wcroc.cfans.umn.edu/research-programs/renewable-energy/ammonia>
12. <https://www.ammoniaenergy.org/articles/green-ammonia-plants-win-financing-in-australia-and-new-zealand/>
13. <https://orsted.com/en/media/newsroom/news/2020/10/143404185982536>
14. <https://www.ammoniaenergy.org/articles/saudi-arabia-to-export-renewable-energy-using-green-ammonia/>
15. Green ammonia: Haldor Topsoe's solid oxide electrolyzer – AMMONIA INDUSTRY
16. Skovgaard Invest indleder PtX-projekt med Vestas og Haldor Topsøe | Wind Denmark

104 Methane pyrolysis

Contact Information:

Energinet: Peter Erik Jørgensen, pir@energinet.dk and Rasmus Thorsen, rto@energinet.dk

Danish Energy Agency: Filip Gamborg, fgb@ens.dk

Authors: This note is compiled by Ali Modara-Hansen (Rambøll) and Eva Ravn Nielsen (Rambøll).

Publication date

April 2021

Qualitative Description

Brief Technology Description

Methane pyrolysis is also known as methane cracking or methane decomposition. This is the process of converting methane (CH₄) into gaseous hydrogen (H₂) and solid carbon (carbon black). The reaction is endothermic and requires relatively high temperatures to occur (≥800 °C). The reaction energy can be provided either through conventional means, e.g. electrical heaters, or alternatively using plasma. Combustion of fuel can also be used as an energy source but causes greenhouse gas (GHG) emissions.

The methane pyrolysis reaction is given in the following equation:



The reaction can occur at differing energy levels depending on the means of process. The process means are divided into three categories which are: thermal-assisted, plasma-assisted, and catalytic assisted. Each category operates at different temperatures and therefore require differing methods of operation. It is important to note that not all these methods are equal in ease of implementation, however, it is important to mention them in order to understand the different forms of methane pyrolysis. Each method is also accompanied by a Technology Readiness Level (TRL), which is a number rating to help estimate the maturity of technologies during the acquisition phase of a program. TRLs are based on a scale from 1 to 9 with 9 being the most mature technology (Ref. [23]).

Thermal-assisted decomposition requires temperatures above 1000 °C and the heat input to the reaction can be provided by heating the reactor walls, by hot molten metal, or by heated carbon granules. The technology is subdivided as follows:

- **Heated-wall reactor (TRL 3):** When using the heated reactor wall method, the reaction occurs close to the walls which creates carbon deposits on the surfaces inside the reactor and hydrogen gas in the empty space. The process is shown in Figure 1. The main advantage of this process is the simplicity of the design since it is mostly an empty reactor with heaters around the reactor walls. However, since the heat is transferred by the reactor walls, the reaction occurs close to the reactor walls and would eventually reduce the heat transfer potential by covering the walls in carbon

deposits. Even though this process operates continuously, it requires frequent shutdowns to clean the reactor and restore the heat transferability of the reactor. One type of heated-wall reactor has been announced by EGT Enterprises (see Table 1, Ref. [20], [21]). The process is shown in Figure 1.

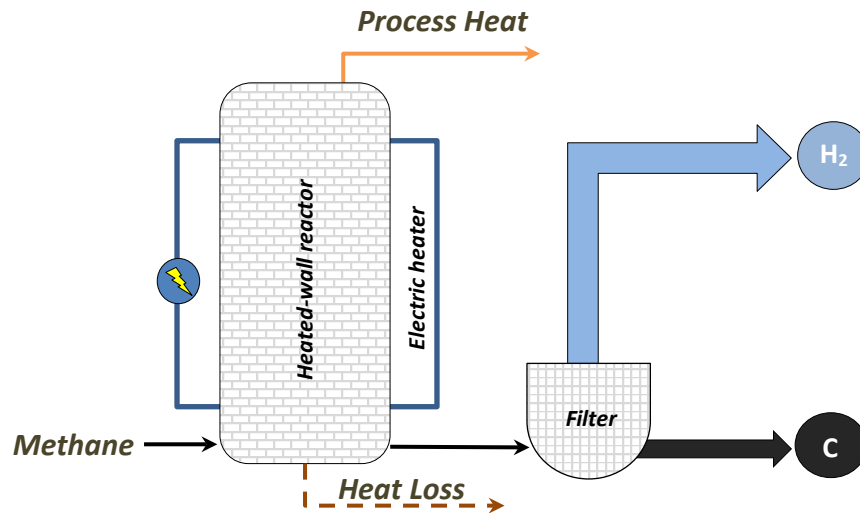

Figure 1. Thermal-assisted (heated-wall) Decomposition Diagram.

- Molten-metal reactor (TRL 3):** In the molten metal process, the metal is heated by an electrical heater and the methane is bubbled through the molten metal which heats up the gas to the reaction temperature. After conversion, the solid carbon product and hydrogen gas rise to the top of the molten metal where they are removed from the reactor. The process is shown in Figure 2. The main advantage of the process is the efficient heat transfer by the molten metal to the methane. The main drawback is that the process is currently only performed in a batch operation due to the removal of the carbon black. However, the removal of the carbon black is simple, since it is manually scraped from the top of the molten metal. There will be a metal loss, which is replenished at every batch.

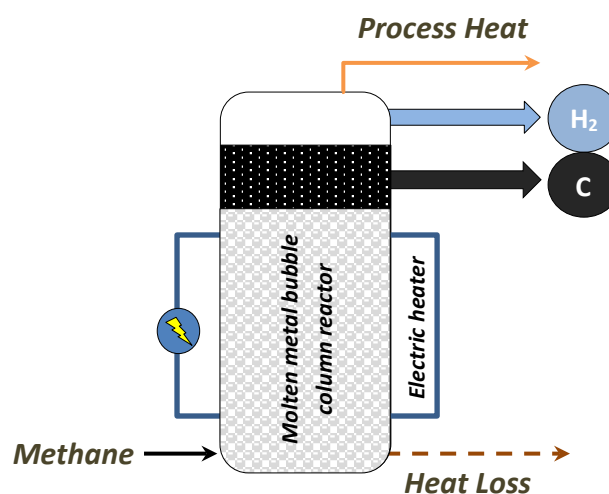

Figure 2. Thermal-assisted (Molten Metal) Decomposition Diagram.

No known molten metal reactor projects are currently being developed by any company. The process is shown in Figure 2.

- **Moving-bed reactor (TRL 4):** The process operates continuously where carbon granules are heated and then moved into a moving bed. The methane gas is passed through the reactor where the reaction occurs close to the carbon granules. The formed carbon from the reaction is removed from the reactor along with the now 'cold' carbon granules. The carbon black and carbon granules are taken into a separator where they are separated based on size, since the granules are larger than the carbon black, which is fine. The carbon granules are recycled into the reactor from the separator where they are heated by the 'hot' hydrogen gas leaving the reactor. This process is being developed by BASF (see Table 1, Ref. [17]) and with a test pilot under construction. The process is shown in Figure 3.

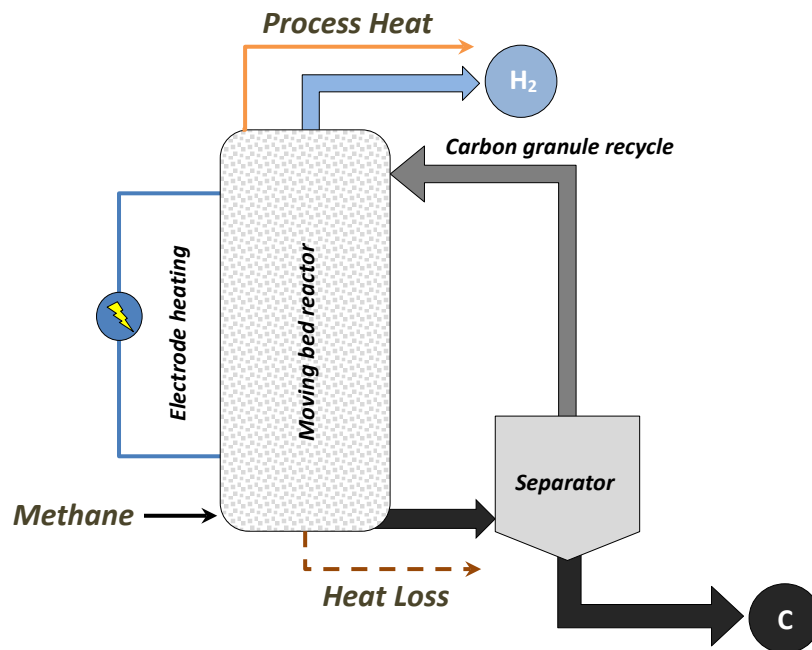

Figure 3. Thermal-assisted (moving-bed reactor) Decomposition Diagram.

Plasma-assisted decomposition (TRL 6) requires temperatures around 2000 °C which is generated using a plasma torch. The high temperatures are at the location of the plasma torch and will not be in contact with the reactor material, just the gas. The methane gas is fed to the plasma torch and the resulting gas is circulated within the reactor to stabilize the plasma. When removing the hydrogen gas and carbon black from the reactor, they are passed through a filter where they are separated. The plasma decomposition process can also employ a catalyst bed which can reduce the required conversion temperature to around 1000 °C. One type of plasma reactor is being developed by the company Atlantic Hydrogen (see Table 1, Ref. [15], [16]). The process is shown in Figure 4.

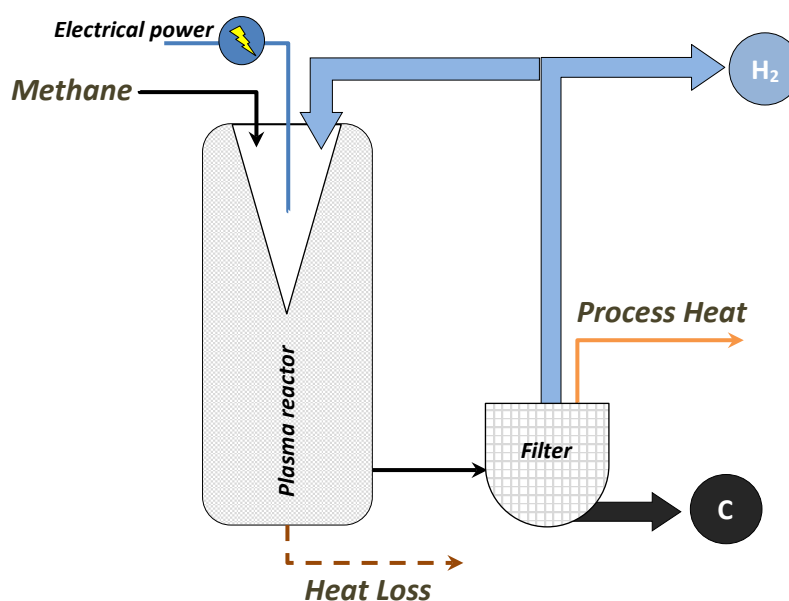

Figure 4. Plasma-assisted Decomposition Diagram.

Catalytic decomposition (TRL 4) process can work at temperatures from 800-1000 °C which is generated using combustion burners. The pyrolysis reactor has a fluidized bed of catalyst inside and the conversion reaction deactivates the catalyst with time due to the generated carbon. The generated carbon and deactivated catalyst are removed from the pyrolysis reactor and passed through a separator to remove the carbon black. The deactivated catalyst can either be removed and replaced with fresh catalyst or regenerated by using a separate reactor which will burn off the carbon residue from the catalyst. The regenerated catalyst can then be fed back to the pyrolysis reactor in a constant cycle of deactivation and regeneration. However, regenerating catalyst produces CO₂ in the process and would require a carbon capture system (CCS) to prevent Green House Gas (GHG) emissions. Implementing a CCS into this process would make it similar in complexity to steam-methane reforming (SMR) technology. In this case, SMR would be preferred since it is a more established hydrogen technology which also produces GHG emissions. Therefore, this method will not be considered since the objective is to produce hydrogen without producing CO₂. This type of process is used by the company Universal Oil Products (UOP) named the Hypro Process (see Table 1, Ref. [22]). The process is shown in Figure 5.

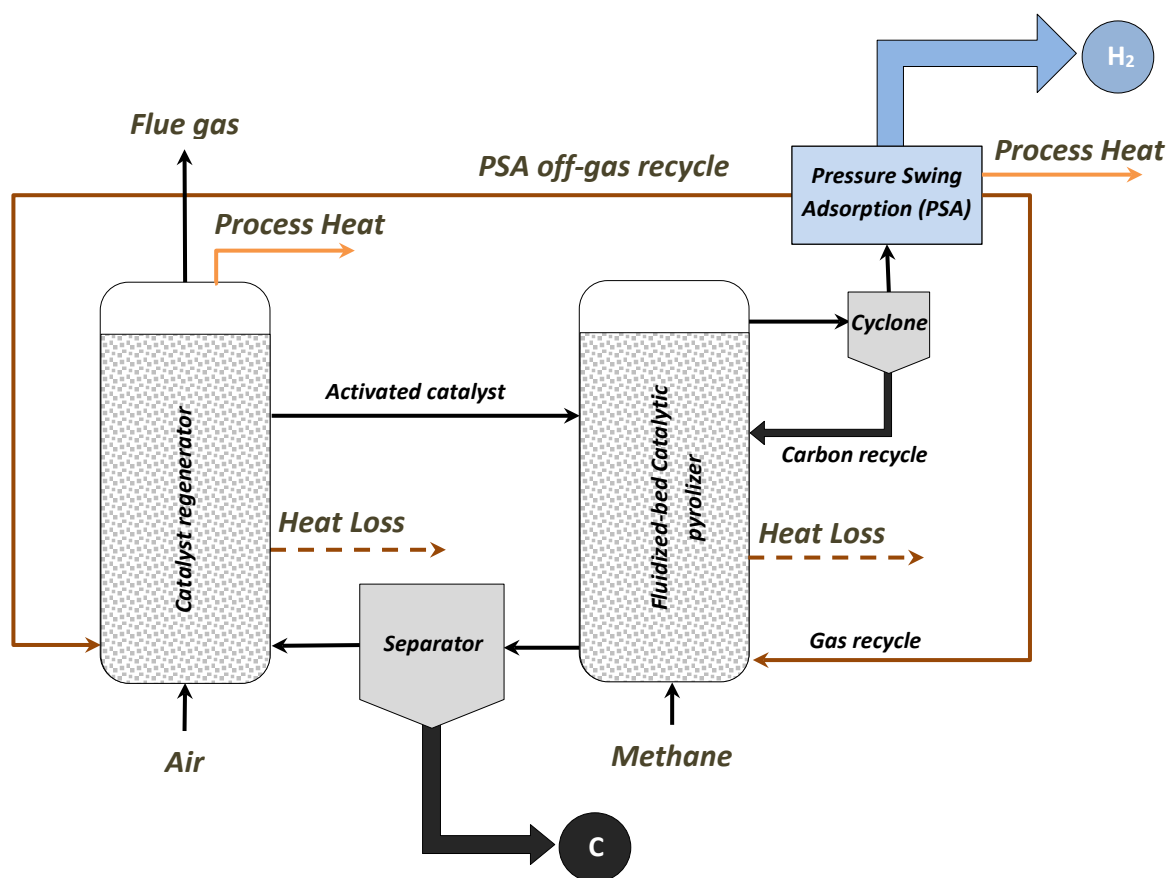

Figure 5. Fluidized Bed Catalytic-assisted Decomposition Diagram.

The following sections are focused on the thermal-assisted moving-bed pyrolysis reactor (MBR) and the plasma-assisted pyrolysis reactor. These have the highest degree of maturity, both in terms of TRL levels and pilot projects (see Table 1). The Heated-wall reactor would require too frequent shutdowns which will affect the production and have higher maintenance costs compared to the other methods, and the fluidized-bed reactor method creates GHG emissions in the process. Therefore, these methods will not be considered in the following sections.

Input

The input to the process is methane, electricity converted to heat or plasma, and optionally some catalyst. In both, the MBR and plasma reactor, the pyrolysis occurs at atmospheric pressure. The gas that is used in the experiments have been pure methane (Ref. [1], [2]). However, it is possible to use natural gas/upgraded biogas, keeping in mind that the lower gas purity (<100% CH₄) will mean the formation of by-products such as ethene, acetylene, and propene from the pyrolysis of ethane and propane. Also, impurities in the gas, e.g. sulphur/chlorine/CO₂ should be removed before entering the process, as these can cause issues/contamination of the process equipment.

Output

The output of the process is hydrogen gas, carbon black, and deactivated catalyst (when using catalyst). Waste heat is also generated which can be captured (e.g. as steam using boilers) and reused (e.g. district heating). Any heat that cannot be captured is counted as a heat loss. In the cases where the heat is generated using combustion burners, then flue gas is also an output. Some of the methane also exits the process but is recycled back into the process along with the inputs. Therefore, un-converted methane is not considered an output since it is recycled. The output hydrogen is at atmospheric pressure. However, it is possible to add a compressor to the plant to pressurize the hydrogen before export. This would require additional investment costs for purchase and installation of the equipment, and an increase in the O&M costs to run the compressor train.

Process Energy Balance

The energy balances for MBR thermal-assisted pyrolysis and plasma-assisted pyrolysis are shown in this section. The energy balances only include the inputs and outputs of the process reaction, and do not include peripheral inputs, e.g. general plant electricity usage. The reaction zone temperatures for each method are similar to the temperatures stated in the technology description section of this report. The energy generated during the process is assumed to be recoverable to the same extent as in standard SMR or autothermal reforming (ATR) hydrogen processes, i.e. by using waste heat boilers which are able to recover 80% of the waste heat from the generated gas (Ref. [13]), while the rest is assumed as a heat loss. The recovered heat can then be exported as steam to be used in other applications, such as district heating. The processes also do not take into account the formation of by-products such as ethene and acetylene since the focus is on methane conversion instead of natural gas conversion. In the energy balances the conversion rate for the methane is assumed to be 89%, with the 11% unconverted methane able to be recycled back into the process. Of the converted methane, the energy balance assumes a 100% stoichiometric conversion, meaning the methane is only converted to hydrogen and carbon black with no by-product formation. The converted methane produces 59% H₂ and the rest as carbon black (Ref. [2]). One of the main ways to improve the process would be to increase the conversion rate. Lower Heating Values (LHV) are used for the calculations. These are: Methane 50.0 MJ/kg, Hydrogen 120.0 MJ/kg, and Carbon black 28.0 MJ/kg.

The energy balance for MBR thermal-assisted methane decomposition is shown in Figure 6.

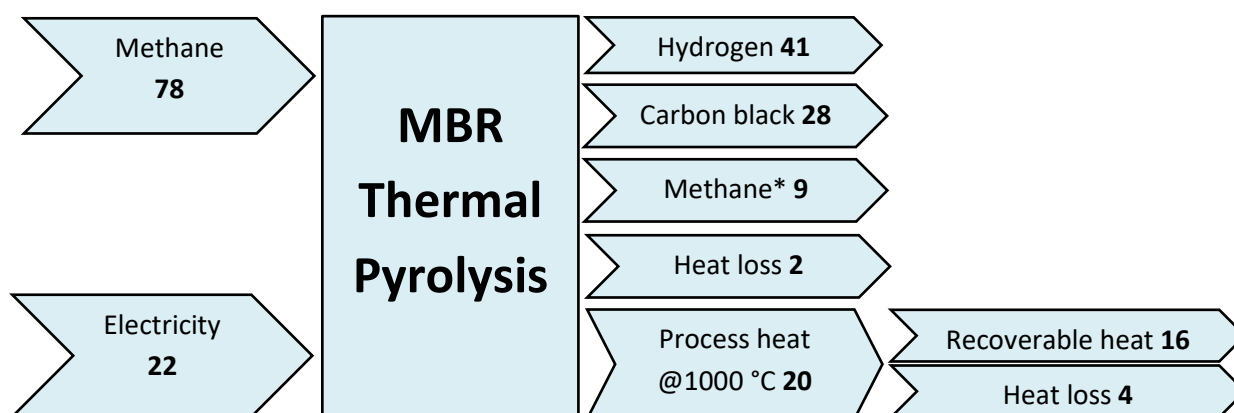

Figure 6. MBR Thermal-assisted Decomposition Energy Balance. *Unconverted, able for recycling to avoid methane slip.

The data stated for this process is based on a scientific paper which presents a techno-economic analysis of four concepts that apply the thermal-assisted decomposition of methane in order to reduce carbon dioxide emissions in natural gas combustion (Ref. [3]). The conversion rate of the process is around 89% and will be used in the BASF methane pyrolysis test plant being constructed in Ludwigshafen, Germany.

The energy balance for plasma-assisted methane decomposition is shown in Figure 7. This data is based on an experimental examination using a modified version of a direct-current plasma reactor originally developed for the conversion of methane to hydrogen with a conversion rate of 89% (Ref. [2]). The reaction zone temperature is around 2000 °C.

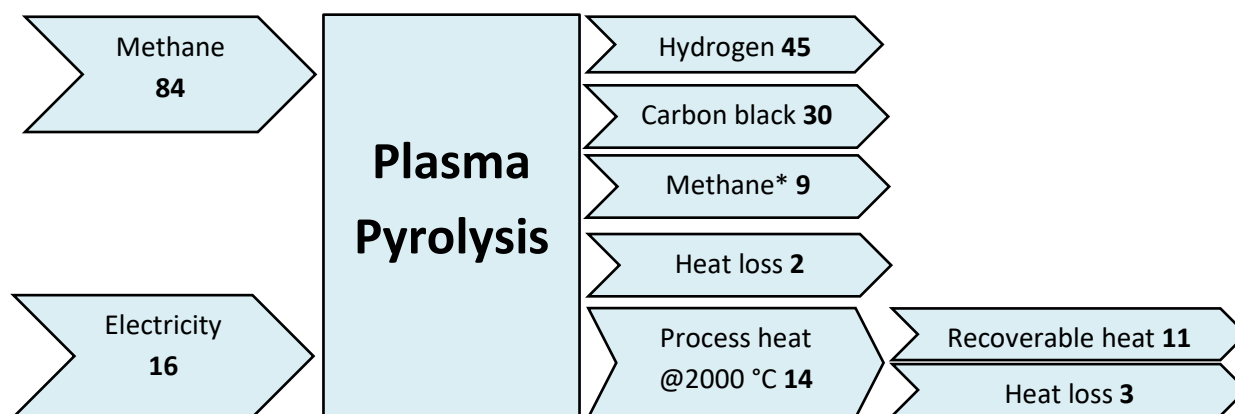

Figure 7. Plasma-assisted Decomposition Energy Balance. *Unconverted, able for recycling to avoid methane slip.

It is possible that as the technologies mentioned reach maturation and more practical knowledge is gained while operating methane pyrolysis plants on a large scale, then the processes would become more energy efficient.

Typical Capacities

Currently, the information with regards to production capacities of methane pyrolysis plants is very limited as the technology is still in the plant testing phase with the primary example being the test plant undergoing construction by BASF in Ludwigshafen, Germany. This plant will feature a thermal-assisted pyrolysis reactor with a moving bed of carbon granules that are heated directly using electrodes [Ref. [4]].

Regulation Ability

Information regarding capacity regulation of the process is very limited due to the early stage of the technology.

Space Requirements

The size of the different pyrolysis configurations mentioned in the techno-economic analyses found in literature does not state the area required for the plants. There also have not been any large-scale industrial methane pyrolysis plants built.

Advantages/Disadvantages

The main advantage of this process is the production of hydrogen gas without the production of CO₂, so called “turquoise hydrogen”, when compared to SMR plants without CCS (Ref. [11]). The CO₂ footprint of a

methane pyrolysis process is comparable to SMR/ATR plants with CCS, but are still higher than the CO₂ footprint of electrolysis processes (Ref. [11]). In order to reduce CO₂ emissions in general, there is a focus on technologies for hydrogen production with less emissions than by the ordinary SMR/ATR of natural gas. When producing so-called “blue hydrogen”, SMR or ATR is combined with carbon capture, where the generated CO₂ is captured for subsequent storage. The obvious advantage of methane pyrolysis is that the captured carbon from this process is in a solid state in terms of carbon black which makes the handling and subsequent storage possibilities significantly easier. The solid carbon generated from the process can either be sold or stored underground (e.g. abandoned mines) with very little environmental effect.

The efficiencies of the different pyrolysis are generally very high, around 90% methane conversion (Ref. [3]), with the remaining 10% being recycled which prevents methane leakage. The heat input to the process can be generated through electricity from renewable sources. The process is at atmospheric pressure and therefore less costly than pressurized processes. [Ref. [2], [5], [6]]. The two areas for improvement in the process efficiency would be improvement to the transfer of heat to the input gas, and improvement in the heat recovery to minimise heat loss.

The disadvantages of the process include the low demand on carbon black in the market, with current examples of applications being as black pigment and as coating material to improve conductivity. There is also potential for more uses for carbon black as activated carbon once it is chemically treated to remove heavy metals and other impurities (Ref. [12]). Activated carbon is a very useful material and has a wide range of applications for example in the medical industry to treat poisoning and in the agricultural industry as a pesticide. Another benefit of carbon black is its ease of handling since it is solid as compared to CO₂ in decarbonization. When carbon is being produced in the process, the heat transfer to the methane gas inside the reactor decreases due to the carbon deposits and requires frequent cleaning. The high temperatures of the process potentially deteriorate the process equipment and would require expensive construction material, regular maintenance and frequent replacement. Since the process operates at atmospheric pressure and high temperatures, it is less flexible in capacity regulation. [Ref. [2][5][6]].

Environment

The GHG emission reductions of methane decomposition systems are dependent on the source of electricity. If the electricity used in the process is generated from renewable sources such as wind power, then the GHG emissions would be 72% lower than that of SMR since SMR plants use gas combustion burners as the energy source to the hydrogen production process. The emissions of methane pyrolysis using renewable electricity is therefore comparable to GHG emissions of SMR including CO₂ capture and storage (CCS). These comparisons are shown in Figure .

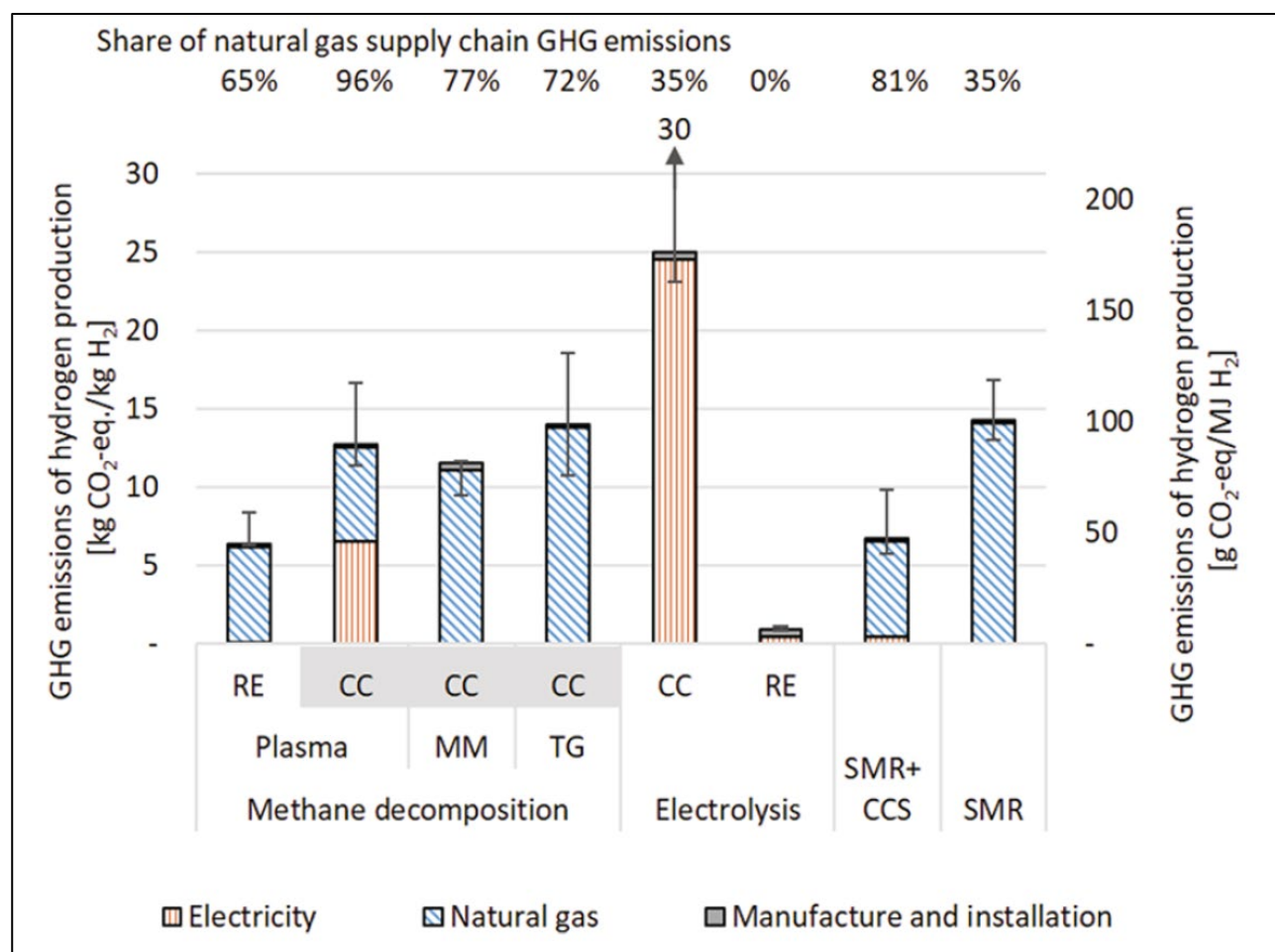

Figure 8. GHG emissions estimation of hydrogen production (grey background indicates methane decomposition systems using natural gas as basis for process energy; electricity from combined cycle power plants (CC) or renewable energy (RE); methane decomposition in molten metal (MM) and thermal gas (TG, i.e. MBR) system; steam methane reforming (SMR) without or with CO₂ capture and storage (+CCS)), (Ref. [11])

Assuming that the methane source of the methane decomposition process is sourced from fossil fuels, then substantial GHG emissions arise also from the overall supply chain of the natural gas. These emissions would then contribute up to 96% of the hydrogen related GHG emissions (Ref. [9]). These GHG are not part of the methane decomposition process and therefore cannot be reduced by CO₂ capture and storage (CCS). They can only be reduced if the GHG emissions would be decreased throughout the overall natural gas supply chain, possibly by changing the gas supply, for example to biogas.

Research and Development Perspective

Methane pyrolysis is a Category 2 technology, due to the technology existing in the pilot plant stage. There is significant uncertainty with respect to the performance and costs of the technology as no pilot plants have finished construction and testing. The following figure and description explain the categorization.

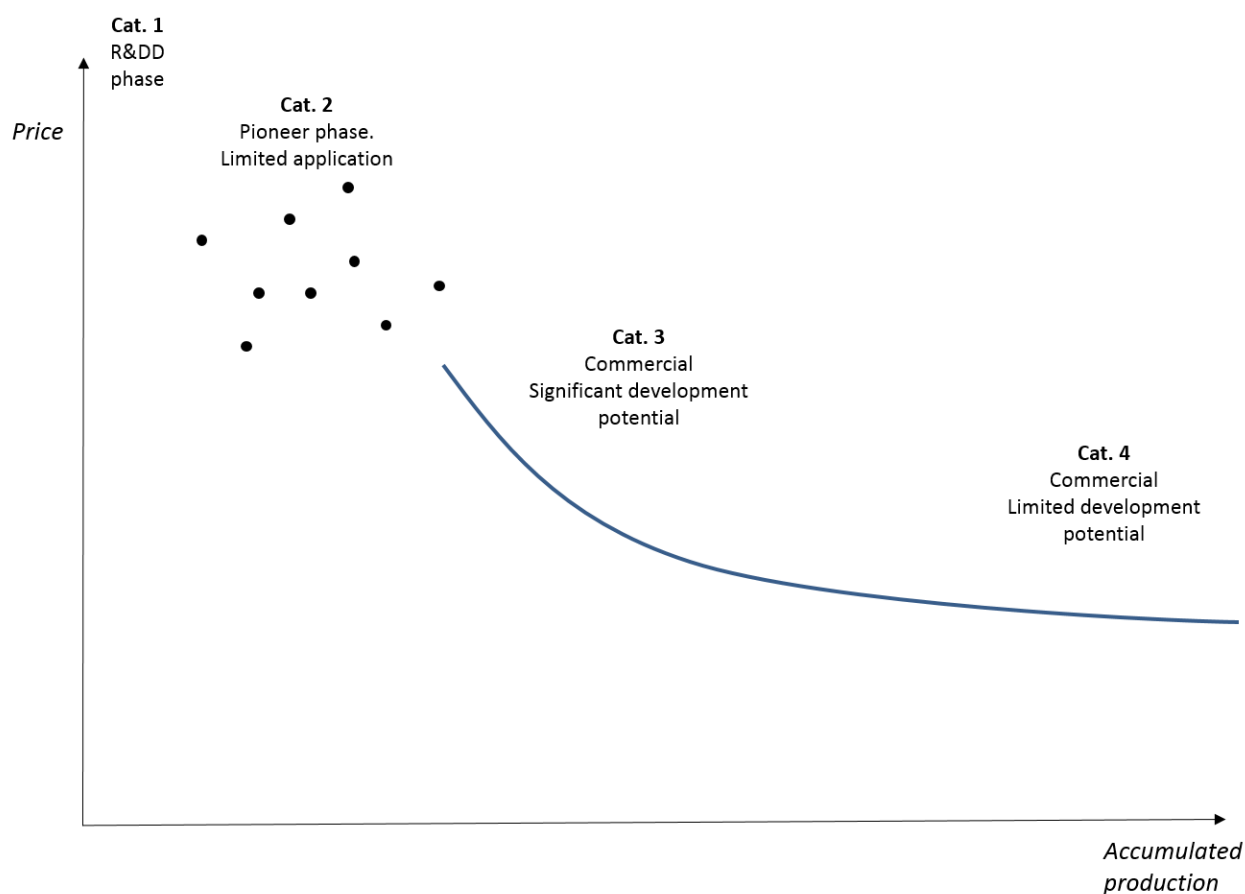

Figure 9: Technological development phases, correlation between accumulated production volume (MW) and price.

The classification is described as follows: “**Category 2. Technologies in the *pioneer phase*. The technology has been proven to work through demonstration facilities or semi-commercial plants. Due to the limited application, the price and performance is still attached with high uncertainty, since development and customization is still needed. The technology still has a significant development potential (e.g. gasification of biomass).**”

The current challenges for future industrial implementation of this technology are the scalability of the processes and the generation of large amounts of carbon black products for small demand markets.

There are a number of methane pyrolysis pilot plant projects that have been implemented and are currently being built by several companies which are listed in Table 1.

Table 1. Commercial methane decomposition projects.

Process; company name	Technology type	Project development status	Process / project information
CarbonSaver; Atlantic hydrogen (Ref. [15], [16])	Thermal plasma	Pilot plant commissioned in 2009 in New Brunswick (Canada); demonstration plant announced	<ul style="list-style-type: none"> - Production of hydrogen enriched natural gas (ca. 20% hydrogen) and carbon black - Thermal plasma torch reactor operating at 1750 – 2800 K
BASF, Linde and Thyssenkrupp (Ref. [17])	Moving-bed reactor		<ul style="list-style-type: none"> - Non-catalytic methane decomposition - High degree of heat integration
Monolith Materials (Ref. [18], [19])	Thermal plasma	Pilot plant operating for 4 years until 2018; commercial plant in Nebraska (USA) under construction (announced commissioning in 2020)	<ul style="list-style-type: none"> - Production of carbon black; hydrogen is by-product to be used in coal-fired power plant - Thermal plasma process
EGT Enterprises (Ref. [20], [21])	Heated wall reactor	Demonstration plant announced	<ul style="list-style-type: none"> - Production of carbon black and hydrogen - Electrically heated chemical reactor operating at 1350 – 1500 K - Electricity production by hydrogen combustion in gas turbine and by using the carbon in a direct carbon fuel cell
HYPRO; Universal Oil Products (UOP) (Ref. [22])	Fluidized-bed reactor		<ul style="list-style-type: none"> - Production of hydrogen - Fluidized bed reactor with Ni/Al₂O₃ catalyst operating at 1150 – 1450 K - Regeneration of catalyst through combustion with air

Examples of Market Standard Technology

Since this is a Category 2 technology, there are no market standard technologies. One of the leading development companies with this technology is the company BASF SE. They have a pilot plant based on

thermal-assisted methane pyrolysis under construction in Ludwigshafen, Germany (as of year 2020) with the key components being installed.

Prediction of Performance and Cost

The methane pyrolysis process is not yet implemented commercially and therefore very little information on the actual performance is available. However, several pilot plants may be built in the next few years (Ref. [11]) which will indicate the viability of this process and help in predicting the performance and cost for the coming years.

Uncertainty

There is significant uncertainty with respect to performance and economics due to the early stage of the development of the technology.

Quantitative Description

Typical total plant size

There is some difference in capacities between the outputs of the different types of methane pyrolysis. Some projected capacities are given in Table 2.

Input and Output

The input and output data shown in the following table is the source of information used for the energy balances shown in Figure 6 and Figure 7. It should be noted that these values are techno-economic analysis numbers which combine process modelling, engineering design, and economic evaluation of the technology at a large-scale based on small-scale testing and analysis. Since these technologies are not yet commercialized, they are more speculative and have uncertainties with regards to future cost of equipment, labor, consumables, and construction.

Table 2. Mass and Energy Flows (Ref. [1], [3]).

Process Type	Inputs		Outputs				
	Methane consumption [kWh/kg H ₂]	Electricity consumption [kWh/kg H ₂]	H ₂ produced [kg H ₂ /day]	Carbon yield [kg C/kg H ₂]	Methane unconverted* [kg CH ₄ /kg H ₂]	Heat recovery [kWh/kg H ₂]	Heat loss [kWh/kg H ₂]
Moving-bed reactor	62.3	17.7	23,000	3.0	0.5	18.4	6.4
Plasma	61.7	12.2	89,000	3.0	0.4	13.3	5.2
SMR without CCS	51.6 (48.6 – 60.0)	-	450,000 (160,000 – 1,100,000)	-	0.3	26.7	6.7
SMR with CCS	54.1 (49.3–80.2)	-	525,000 (216,000 – 1,200,000)	-	0.3	26.7	6.7

*Unconverted methane is recycled into the process to achieve zero methane-leakage.

Forced and planned outage

Plants of similar technologies and process parameters are usually operated for 350 days per year.

Technical lifetime

For a mature technology, plant lifetimes should be a minimum of 20 years, similar to what would be expected in SMR/ATR hydrogen plants (Ref. [6]).

Construction time

Construction time for the technology is assumed to be about 2 years based on experience for SMR/ATR hydrogen plants of similar size and complexity.

Financial data

Due to the current stage of the technology and lack of available public financial information, the data is taken from peer reviewed techno-economic analyses (Ref [1], [3]).

Investment and Operation & Maintenance costs

The investment costs usually include the procurement of the main equipment, piping, and other hardware as well as the labour cost for installing the new equipment and setting up the control system for the equipment. It should be noted that the investment is only taken as an initial cost, and does not, for example, include replacement catalyst (in the case of catalytic reactions). The O&M costs are calculated as a cost per year and are a percentage of the total investment cost (i.e. equipment, piping, labour, and additional costs). The costs are given below in Table 3. The table does not include electrolysis since the inputs to that process are different to the processes mentioned in the table.

Table 3. Investment costs per kg/h H₂ produced (values in brackets show published bandwidth) (Ref. [1], [3], [11], [14]).

Process Type	Investment [€/kg H ₂ /h]	Annual O&M cost* [% of investment]
Moving-bed reactor	20,000 (8,500–36,000)	2.0
Plasma	28,000 (3,300–152,000)	3.0
SMR without CCS	12,500 (8,500–19,200)	5.0
SMR with CCS	14,500 (10,700 – 39,700)	5.0

*Only includes fixed O&M costs.

Start-up costs

The start-up costs are not available.

Data sheets

Technology	Moving-bed Methane Decomposition									
	2020	2030	2040	2050	Uncertainty (2030)		Uncertainty (2050)		Note	Ref
					Lower	Upper	Lower	Upper		
Energy/technical data										
Typical total plant size (MW input)	N/A	77	85	93.5	38.5	115.5	47	140	A, G, H, I	
Typical total plant size (MW H ₂ output)	N/A	32	35	39	16	48	19.5	58.5	A, F, G	[2]
Typical total plant size (kg H ₂ / day output)	N/A	23000	25000	28000	12000	35000	14000	42000	A, E, G, K	[2]
- Inputs										
Natural Gas (% total input (MWh / MWh))	N/A	78	80	82	76	80	78	84	A, G, H	[2]
Electricity (% total input (MWh / MWh))	N/A	22	20	18	20	24	16	22	A, G	[2]
- Outputs										
Hydrogen Gas (% total input (MWh / MWh))	N/A	41	42	43	37	45	39	47	A, F, G	[2]
Carbon Black (% total input (MWh / MWh))	N/A	28	29	30	25	31	27	33	A, G, N	[2]
Methane (% total input (MWh / MWh))	N/A	9	8	7	4.5	13.5	3.5	10.5	A, G, H, M	[2]
Recovered Heat (% total input (MWh / MWh))	N/A	16	15	14	8	24	7	21	A, G	[2]
Heat loss (% total input (MWh / MWh))	N/A	6	6	6	5	9	3	9	A, G	[2]
Forced outage (%)	N/A	20	10	1	10	30	0	2	A	
Planned outage (weeks per year)	N/A	10	4	2	10	22	0	0	A, C, D, G	
Technical lifetime (years)	N/A	20	25	25	15	25	20	30	A, G	[6]
Construction time (years)	N/A	2	2	2	1.5	2.5	1.5	2.5	A, D, G	
Financial data (2015)										
Specific investment (M€ / MW of total H ₂ output)	N/A	0.6	0.5	0.5	0.3	0.9	0.2	0.7	A, B, F, G, J, K	[1], [3]
- hereof equipment (%)	N/A	50	50	50	45	55	45	55	A, G	
- hereof installation (%)	N/A	50	50	50	45	55	45	55	A, G	
Fixed O&M (€ / MW of total H ₂ output / year)	N/A	12000	11000	9700	6000	18000	4900	15000	A, B, G	[1], [3]
Variable O&M (€ / MWh of total H ₂ output)	N/A	4	4	3	2	6	2	5	A, G, L	[1], [3]
Startup cost (€ / MW of total H ₂ output)	N/A	N/A	N/A	N/A	N/A	N/A	N/A	N/A		
Technology specific data										
Methane conversion (%)	N/A	89	90	91	N/A	N/A	N/A	N/A	A, G, M	

Technology	Plasma-assisted Methane Decomposition									
	2020	2030	2040	2050	Uncertainty (2030)		Uncertainty (2050)		Note	Ref
					Lower	Upper	Lower	Upper		
Energy/technical data										
Typical total plant size (MW input)	N/A	273	300	330	136.5	409.5	165	495	A, G, H, I	[2]
Typical total plant size (MW H ₂ output)	N/A	125	140	150	62.5	187.5	75	225	A, F, G	[2]
Typical total plant size (kg H ₂ / day output)	N/A	89000	98000	110000	45000	130000	55000	160000	A, E, G, K	[2]
- Inputs										
Natural Gas (% total input (MWh / MWh))	N/A	84	86	88	82	86	86	90	A, G, H	[2]
Electricity (% total input (MWh / MWh))	N/A	16	14	12	14	18	10	14	A, G	[2]
- Outputs										
Hydrogen Gas (% total input (MWh / MWh))	N/A	45	46	47	41	49	43	51	A, F, G	[2]
Carbon Black (% total input (MWh / MWh))	N/A	30	31	32	27	33	29	35	A, G, N	[2]
Methane (% total input (MWh / MWh))	N/A	9	8	7	4.5	13.5	3.5	10.5	A, G, H, M	
Recovered Heat (% total input (MWh / MWh))	N/A	11	10	10	5.5	16.5	5.0	15.0	A, G	[2]
Heat loss (% total input (MWh / MWh))	N/A	7	6	5	4	10	2	8	A, G	[2]
Forced outage (%)	N/A	20	10	1	10	30	0	2	A	
Planned outage (weeks per year)	N/A	16	4	2	10	22	2	4	A, C, D, G	
Technical lifetime (years)	N/A	20	25	25	15	25	20	30	A, G	[6]
Construction time (years)	N/A	2	2	2	1.5	2.5	1.5	2.5	A, D, G	
Financial data (2015)										
Specific investment (M€ / MW of total H ₂ output)	N/A	0.8	0.8	0.7	0.4	1.3	0.3	1.0	A, B, E, F, G, J, K	[1], [3]
- hereof equipment (%)	N/A	50	50	50	45	55	45	55	A, G	
- hereof installation (%)	N/A	50	50	50	45	55	45	55	A, G	
Fixed O&M (€ / MW of total H ₂ output / year)	N/A	25000	23000	20000	13000	38000	10000	31000	A, B, G	[1], [3]
Variable O&M (€ / MWh of total H ₂ output)	N/A	4	4	3	2	6	2	5	A, L, G	[1], [3]
Startup cost (€ / MW of total H ₂ output)	N/A	N/A	N/A	N/A	N/A	N/A	N/A	N/A		
Technology specific data										
Methane conversion (%)	N/A	89	90	91	N/A	N/A	N/A	N/A	A, G, M	

Notes:

- A. The technology is not available in 2020.
- B. The cost estimate is highly dependent on the materialization of the pilot plants currently being built and their performance. If reaching a mature technology level by 2030, it is expected that some cost reduction will occur in the coming years, but the level of cost reduction is uncertain.
- C. The planned outages might be higher than stated in the early stages of the technology development.
- D. The estimate is based on previous engineering experience.
- E. The value is an average of published bandwidth values.
- F. The Lower Heating Value (LHV) of the hydrogen used is 120 MJ/kg.
- G. The projected values for 2040 and 2050 are assumed based on a 10% change over time. This is due to potential improvements in the efficiency of the process, optimization of the operation of the technology, and reduction in the prices of material/equipment/inputs.
- H. Total input of electricity and methane energy converted through methane LHV of 50.0 MJ/kg.
- I. Plant size based on input is a combination of methane consumption and electricity input.
- J. The investment cost includes the process units and associated equipment needed to start up the plant. It does not include peripheral equipment such as buildings (e.g. control rooms) or electrical interfaces.
- K. The techno-economic analysis for both investment and sizing is based on theoretical conversion models coupled with actual energy and material costs at the time of the analysis.
- L. The variable O&M is calculated to be similar to SMR technology excluding the cost of natural gas input and carbon tax. What is included is process cooling costs and general wear and tear.
- M. Unconverted methane is recycled to prevent methane slip.
- N. The Lower Heating Value (LHV) of the carbon black used is 28.0 MJ/kg.

References

- [1] Brett Parkinson, J. W. (2017). Techno-Economic Analysis of Methane Pyrolysis in Molten Metals: Decarbonizing Natural Gas. *Chemical Engineering Technology*, 1022-1030.
- [2] Gaudernack, B., & Lynum, S. (1998). Hydrogen from natural gas without release of CO₂ to the atmosphere. *Hydrogen Energy*, 1087-1093.
- [3] Tiina Keipi a, V. H. (2016). Techno-economic analysis of four concepts for thermal decomposition of methane: Reduction of CO₂ emissions in natural gas combustion. *Energy Conversion and Management*, 1-12.
- [4] A. Bode, New process for clean hydrogen, BASF Research Press Conference, Ludwigshafen, January 2019.
- [5] T. Geißler, M. Plevan, A. Abánades, A. Heinzl, K. Mehravaran, R. K. Rathnam, C. Rubbia, D. Salmieri, L. Stoppel, S. Stückrad, A. Weisenburger, H. Wenninger, T. Wetzel, *Int. J. Hydrogen Energy* 2015, 40 (41), 14134–14146.
- [6] N. Z. Muradov, Thermocatalytic CO₂-Free Production of Hydrogen from Hydrocarbon Fuels, Technical Report, No. DE-FC36-99GO10456, U.S. Department of Energy, Oak Ridge, TN 2004.

- [7] Phoenix equipment corporation, Fluid Catalyst Cracker (FCC) Unit, <https://www.phxequip.com/>, 2020.
- [8] Beston Machinery Co., Ltd., Pyrolysis Plant Cost, <https://www.bestongroup.com/>, 2020.
- [9] Müller-Syring G, Große C, Glandien J, Eyßer M. Critical Evaluation of Default Values for the GHG Emissions of the. Natural Gas Supply Chain, 2016.
- [10] Andi Mehmeti, Athanasios Angelis-Dimakis, George Arampatzis, Stephen J. McPhail, & Sergio Ulgiati (2018). Life Cycle Assessment and Water Footprint of Hydrogen Production Methods: From Conventional to Emerging Technologies. MDPI, Environments.
- [11] Sebastian Timmerberg, Martin Kaltschmitt, Matthias Finkbeiner. Hydrogen and hydrogen-derived fuels through methane decomposition of natural gas – GHG emissions and costs, Energy Conversion and Management: X, Volume 7, September 2020.
- [12] Pengwei Dong, Thawatchai Maneerung, Wei Cheng Ng, Xu Zhen, Yanjun Dai, Yen Wah Tong, Yen-Peng Ting, Shin Nuo Koh, Chi-Hwa Wang, Koon Gee Neoh. Chemically treated carbon black waste and its potential applications, Journal of Hazardous Materials, Volume 321, January 2017, 62-72.
- [13] Johnston Boiler Company, Waste Heat Recovery Boilers, <https://www.johnstonboiler.com>.
- [14] Selma Brynolf, Maria Taljegard, Maria Grahn, Julia Hansson. Electrofuels for the transport sector: A review of production costs, Renewable and Sustainable Energy Reviews, Volume 81, Part 2, January 2018, 1887-1905.
- [15] Hamilton T. Turning natural gas green: A new process extracts high-value carbon black from methane; Available from: <https://www.technologyreview.com/s/413344/turning-natural-gas-green/>.
- [16] National Grid, Atlantic Hydrogen Inc. Hydrogen-enriched natural gas: Bridge to an ultra-low carbon world; 2009.
- [17] O. Machhammer, H.-J. Maaß, A. Bode Erzeugung von Strom und flüssigen Kraftstoffen mit geringem Carbon Footprint Chem Ing Tech, 90 (1–2) (2018), pp. 212-225, 10.1002/cite.201700137.
- [18] Monolith Materials I. [November 30, 2019]. Available from <https://monolithmaterials.com/>.
- [19] Nebraska Energy Office. Hydrogen Projects in Nebraska. [November 30, 2019]; Available from: <http://www.neo.ne.gov/programs/stats/inf/211.htm>.
- [20] Ennis B, Schulz J. Grid-Scale electricity storage and dispatch; 2015.
- [21] R. Dagle, V. Dagle, M. Bearden, J. Holladay, T. Krause, S. Ahmed, et al. Opportunities for Development of Natural Gas Conversion Technologies: for Co-Production of Hydrogen and Value-Added Solid Carbon Products (2017).
- [22] T.V. Choudhary, D.W. Goodman, Methane Decomposition: Production of Hydrogen and Carbon Filaments, Catalysis, 19 (2006), pp. 164-183
- [23] European Commission, Horizon 2020 – Work Programme 2014-2015, General Annexes – Annex G: Technology Readiness Levels (TRL). Available from: https://ec.europa.eu/research/participants/data/ref/h2020/wp/2014_2015/annexes/h2020-wp1415-annex-g-trl_en.pdf

105 Slow Pyrolysis

Contact information:

Danish Energy Agency: Stefan Krüger Nielsen stni@ens.dk; Thomas Mandal Østergaard tmo@ens.dk

Energinet: Sebastian Frejo Rasmussen srs@energinet.dk

Author: Per Alström, COWI

Publication date

April 2022

Amendments after publication date

Date	Ref.	Description
-	-	-
-	-	-

Qualitative description

Brief technology description

Slow pyrolysis is a technology, which can be used for production of biochar, pyrolysis oil, and combustible gas using farming residues, wood, and other biomaterials as feedstock. Biochar is used for soil improvement and is considered as a method for CO₂-sequestration. Pyrolysis oil is currently mostly used as fuel in e.g., boilers but have a potential to be upgraded to transportation fuels.

Currently, the technology is mainly used for production of biochar in comparably small-scale plants, but a few companies have plans for larger scale production, e.g. Vow ASA/Biogreen, Carbofex, Stiesdal Fuel Technologies A/S, and AquaGreen, see section: Examples of Market Standard Technology.

Slow pyrolysis is thermal conversion of organic matter, e.g. biomass, in absence of or under a deficit of oxygen. In comparison with fast pyrolysis the retention time is longer and can vary between 5 minutes and a couple of hours depending on the equipment supplier. The biomass heating rate is in the range of ~100 °C/min compared to ~1000 °C/s for fast pyrolysis.

Production of biochar by means of slow pyrolysis is a growing business, targeting mainly the market for carbon capture and soil improvement. However, new emerging technologies show that, in addition to biochar, slow pyrolysis can also be used for production of pyrolysis oil and possibly syngas. These supplementary products can be upgraded to replace commercial fossil fuels for transport or used as heat sources in industrial processes.

The pyrolysis process is very flexible in terms of feedstock. However, the feedstock must be pretreated to ensure that size distribution and moisture content fit the process. The demands vary depending on the selected type of process and supplier of the pyrolysis technology.

Below slow pyrolysis used for the production of biochar, gas (or syngas as it often is called), and pyrolysis oil is described. Note that the technology is not yet commercialized in a larger scale.

Pre-treated biomass feedstock is fed into the pyrolysis reactor where it is heated up to 300 to 700°C. The temperature varies between different technology suppliers and the intended distribution of end products. A temperature range of 500 to 600°C is most commonly applied. The retention time in the reactor is typically around 5 to 20 minutes but can be much longer for simpler systems used for biochar production only.

The required feedstock particle size and moisture content also varies depending on the type of reactor used. Normally the particle size is in the 5-10 mm range.

As a general principle, a lower moisture content facilitates a more efficient pyrolysis process. However, low moisture content comes with a cost as the feedstock needs drying. Therefore, the moisture content is typically between 10 and 25%, depending on feedstock used.

In principle there are two kinds of reactors, directly and indirectly heated. In the directly heated reactors a part of the combustible content in the feedstock is used for heating of the reactor by adding a small amount of air i.e. burning a fraction of the feedstock to achieve the correct pyrolysis temperature. Indirectly heated reactors use heat generated outside the reactor, e.g from combustion of pyrolysis gas, which is very common. Electric heating can also be used, see section “Examples of standard market technologies” below.

The amount of energy (heat) needed for the pyrolysis depends on many factors like feedstock moisture content. In the cases studied in more detail in this paper it is 9 or 13% of the energy in the incoming feedstock. Other heat sources than the self-generated gas can be used for heating the pyrolysis process.

Carbonization is the conversion of organic matter into carbon (like biochar) by the use of heat. Many commercial technologies for biochar production are so called autothermal processes, relying on combustion heat for the carbonization of the raw material. Here, no external energy source is required. However, electricity is needed for all system variants to run equipment like conveyers, pumps etc.

Note that the technologies combustion, slow pyrolysis, fast pyrolysis, and gasification has many common features, but also differences which defines them. Fast pyrolysis is the most efficient method to produce bio-oil, while gasification the most efficient method to produce syngas. Slow pyrolysis tends to yield higher proportion of biochar owing to the slow heating rates and longer residence time compared to both fast pyrolysis and gasification.

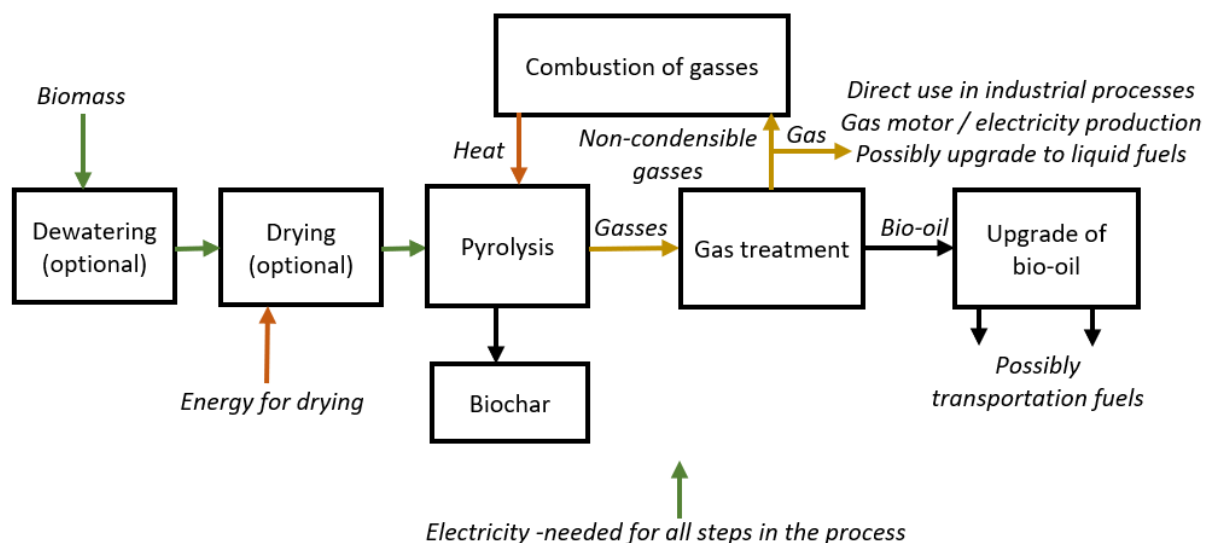

Figure 1. Simplified flowsheet for the slow pyrolysis process main process stages following the biomass from input to end products. Note that the pretreatment steps, dewatering and drying, will be needed if the biomass is wet, e.g. for digestate from biogas production. Electricity will be needed for the operation of machinery used in the process.

Input

The feedstock studied in detail in this chapter are straw and digestate from biogas production.

Other feedstocks used in slow pyrolysis processes are e.g. wood residues, saw dust, sludge, manure, and waste material from both biogenic sources as well as other waste that might contain rubber, plastic etc. The latter is mostly used in pyrolysis plants designed for destruction purposes where the gas only can be used for direct combustion and the char either can be recycled or sent to landfill. The main goal for such destruction purposes is reduction of volume and energy recovery.

The feedstock has to be pre-treated in various ways, depending on feedstock composition and the type of process used, which is set by the technology supplier. The composition and energy content from different feedstock are shown in table 1.

Straw could be pelletized, preferably close to the farms. If harvested and stored in dry conditions, no additional drying should be necessary, however in the calculations made for this report a drier is added to the investment cost. Pelletizing of straw is difficult due to the abrasiveness of this feedstock, as straw is a hard material that tends to wear the equipment. The pelletizing is an energy intensive process not necessarily required prior to the pyrolysis process.

Digestate from biogas production normally must be dewatered and then dried to decrease the moisture content to an acceptable level for the pyrolysis plant. The digestate, referred to in this report, and shown in the table below is from biogas production based on manure. The digestate can also be pelletized down to 10% moisture content by using a screw press or a decanter centrifuge followed by a drying step and finally a pellet press (1).

Raw material	Moisture content, before treatment Weight %	Ash content* Weight % on dry substance	Lower heating value H_{eff} (dry/ash free) MJ/kg	Reference
Straw	10 – 15	4 – 10	17 – 18	(2)
Digestate**	55 – 75	15 – 22	16 – 17	(1)
Wood	8 – 60	4 – 6	19 – 20	(2)
Manure***	55	7	18 – 19	(3), (4)

Table 1. Data for various raw materials for pyrolysis. Typical moisture content after pre-treatment is 10 to 20 w/w %.

*In this context ash is the inorganic matter, minerals etc., in the feedstock, the ash provides no heat to the process but is only to be seen as an inert substance only requiring heating during the pyrolysis.

**The data varies depending on digestate origin and type of process used for biogas production.

***The figures vary a lot depending on origin.

From a pyrolysis point of view the difference between manure and digestate from manure is that some carbon has already been converted in the biogas process and is not available in the pyrolysis process. This leads to a comparably higher ash-content and lower biochar-output of the digestate after pyrolysis.

Mixing wood into the digestate will increase the biochar-output and decrease the ash content leading to a “better” biochar, more likely to be certified, see section regarding biochar and certification below. Garden waste, wood, woody waste material, and similar can be used for this purpose. Note that treated wood, e.g. impregnated or painted, not should be used in case the biochar is intended for agricultural use as contaminants from the paint can pollute the farm land. Woody biomass will need pre-treatment, such as chipping/crushing and drying. Many existing smaller pyrolysis plants are designed for wood as feedstock.

In addition to the feedstock, electricity is also needed for operation of the plant, e.g for conveyers, pumps, and other equipment. Heat is required for the pyrolysis process; some technologies rely on heat generated internally or externally by combustion of a part of the combustible gasses generated in the main pyrolysis process, see section regarding pyrolysis gas below. There are also technologies using electricity as heat source, which in certain cases can be favourable. If electricity generated by wind- or solar-power or other non-fossil sources is used this could be a future option to enhance the yield of products by using electricity instead of the generated pyrolysis gas to run the process. This is described further in section “Pyrolysis gas”.

Output

Two main output streams are produced in the pyrolysis process: biochar and pyrolysis gas. The gas is then separated into pyrolysis oil and non-condensable gas. The biochar is removed continuously from the pyrolysis reactor by means of a hopper or similar equipment. The raw pyrolysis gas from the reactor is a mixture of condensable and non-condensable gasses. This gas is cooled, and the condensable part of the gas is taken out as pyrolysis oil leaving the non-condensable gas to be used for e.g. heating the pyrolysis process.

The raw gas from the pyrolysis process, containing the oil components, can also be used directly as a hot fuel, for the pyrolysis process and/or in other processes, see section regarding pyrolysis gas below.

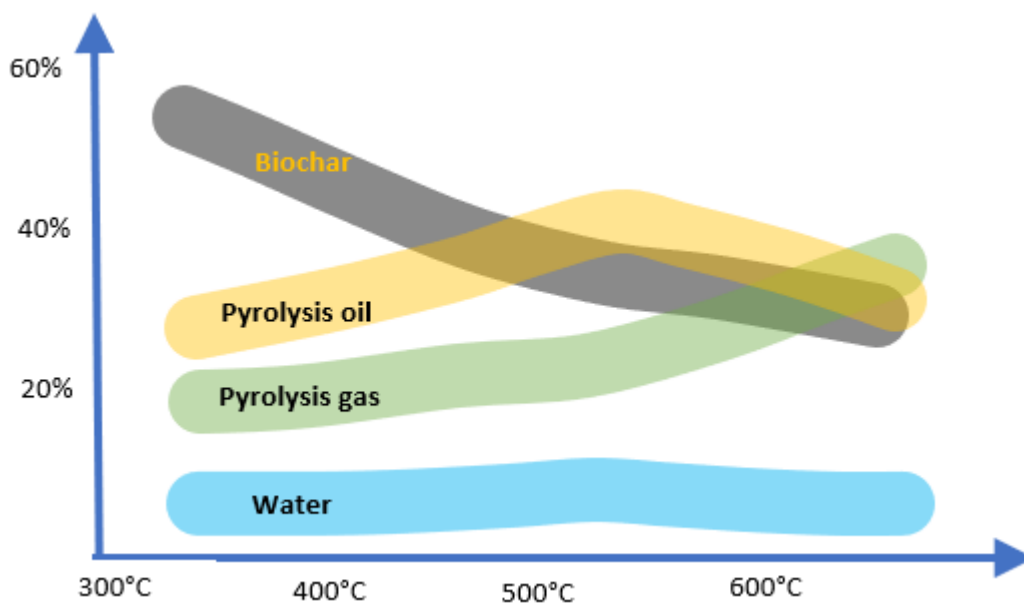

Figure 2. Approximative typical distribution of products depending on pyrolysis temperature. Other factors than temperature also have an impact of this distribution, e.g. particle size, raw material and type of technology used (5).

The product distribution as function of pyrolysis temperature in the slow pyrolysis process is shown in figure 2. The biochar fraction will be dominating at temperatures below 500 °C and the pyrolysis gas will be the dominant product at 600 °C and higher. In general, it will be a trade-off between char/oil and gas, i.e. if more pyrolysis raw gas is produced, less biochar will come from the plant. The distribution of products depends on many factors besides the temperature, including but not limited to type of feedstock, the type of reactor, and the residence time in the reactor. The residence time in the pyrolysis reactor is normally a function of the particle size of the feedstock (7).

Biochar

For many smaller plants, not including the commercial scale plants planned, the primary output is normally biochar. Pyrolysis oil and combustible gas can be seen as by-products in such plants if they are recovered at all.

The hot biochar will leave the reactor at high temperature and will need to be cooled. It may be cooled indirectly by using a water mantled cooler, generating warm water, or it may be cooled directly by adding water to the hot char. Prior to storage and packing the biochar will need to have a certain water content to minimize the risk of self-ignition.

Biochar is traditionally seen as a soil improving agent. However, it can also be used as a carbon sink, i.e. since it degrades so slowly in the soil it can be used for CO₂-sequestration, this is further explained below in this section. The porous structure of the biochar gives it a high specific surface (measured in m²/g) and makes it very suitable to improve farmland quality. Bacteria and fungi can grow in the biochar pores, which improves the possibilities for plants to absorb nutrients and the porous structure absorbs water. Biochar is normally

mixed with e.g., compost or manure in order to load it with nutrients prior to digging/ploughing it down into the soil. This will inoculate both nutrients and micro life into the biochar leading to an improved harvest.

Besides carbon, nearly all ash included in the feedstock will be found in the biochar, also oxygen and hydrogen will be present in certain amounts. The content is mainly depending on the raw material (8). A Danish study on various effects of adding biochar to agricultural soil is ongoing (30).

The European Biochar Initiative (EBC) certifies biochar in Europe and have put up a list of certification requirements for the biochar. Several different classes are described in the EBC guidelines (9). Some of these requirements for the class EBC-AgroOrganic are listed in table 2 below. There are also a number of other requirements, e.g., for the biochar production itself. Carbon Standards International AG is the new hub for EBC certification, climate services, and the C-sink economy (10).

Parameter	Demands/Maximum level
Elemental analysis	Declaration of C_{tot} , C_{org} , H, N, O, S, ash
Hydrogen/Carbon quota (H/C-quota)	<0.7
Physical parameters	Water content (@<3 mm particle size), bulk density (TS), WHC, pH, salt content, electrical conductivity of the solid biochar
TGA	Needs to be presented for the first production batch from a pyrolysis unit
Nutrients	Declaration of N, P, K, Mg, Ca, Fe
Heavy metals	Pb < 45 g/t DM; Cd < 0.8 g/t DM; Cu < 70 g/t DM; Ni < 25 g/t DM; Hg < 0,4 g/t DM; Zn < 200 g/t DM; Cr < 70 g/t DM; As < 13 g/t DM
16 EFSA PAH	4±2 g/t DM
8 EFSA PAH	1 g/t DM
Benzo[e]pyrene benzo[j]fluoranthene	< 1.0 g t-1 DM for each of both substances
PCB, PCDD/F	Once per pyrolysis unit for the first production batch. For PCB: 0.2 mg kg-1 DM, for PCDD/F: 20 ng kg-1 (I-TEQ OMS), respectively

Table 2. Limits for certified biochar according to the European Biochar Certificate.

Trials show that feedstock content of cadmium, mercury, polycyclic aromatic hydrocarbons (PAH), polychlorinated biphenyl (PCB), and dioxins is not directly transferred to the biochar (11).

Certified biochar has a higher market value compared to non-certified. In Germany the market is well developed, still the market value is very much depending on local production and demand. Skånefrö in southern Sweden is marketing biochar sold in big bags for 4300 DKK/m³ in December 2021 (12).

Biochar can also be used for other applications, e.g. as addition to animal fodder to improve animal health and increase growth rate, as filter material, as replacement of coke in the steel industry, as filling material in concrete, as feedstock for the production for activated carbon and carbon black, etc. Also, the biochar has a value as carbon sink and a market is developing fast. The value is partly depending on ash content etc. (6).

Biochar breaks down very slowly compared to other organic material, the half-life is estimated to 150 – 5000 years and it was classified as a negative emission technology by IPCC in 2018. The potential for CO₂ sequestration is large and is mainly achieved by storing organic carbon in soils (SOC). However, as biochar technologies are relatively new, there is a lack of data regarding short and especially long-term stabilization of SOC stocks and their fate after biochar amendment (13). Soil condition, depth of the biochar in the soil and several other parameters have an impact on the final CO₂ sequestration results.

Negative emissions arise when biogenic carbon from biomass is stored in biochar and if biochar is added to mineral agricultural soils these negative emissions can be subscribed to the national greenhouse gas report (31). The net negative emissions can be lower than the biochar carbon content when considering that some of the biomass used would alternatively be stored in for example living biomass in forests or when straw and manure is plowed down into agricultural soils.

About 35 to 60% of the carbon in the feedstock will end up in the biochar, see section regarding carbon balance below.

The biochar will contain nearly all the ash fed into the process with the feedstock, i.e. the higher amount of carbon taken out from the process as pyrolysis oil and gases, the higher the ash content and lower the carbon content will be in the biochar.

The market for biochar is growing and new process and equipment suppliers as well as retailers for products are continuously introduced to the market.

Pyrolysis oil

Pyrolysis oil differs from fossil crude oil in various ways. It contains water, typically ranging from 5% to 25%, has a comparably low heating value, high oxygen content, and a pH-value of less than 3, compared to pH 5-7 for fuel oil. This low pH is a technical challenge from a corrosion perspective. The chemical composition of pyrolysis oil changes when stored for longer times, e.g. by absorbing oxygen from the air (14). In the refinery industry TAN (total acid number) is normally used instead of pH. A pyrolysis oil normally has a TAN between 50-100 mg KOH/g.

The composition of the condensable gas depends on the pyrolysis temperature since the degradation of the components in the biomass occurs at different temperature intervals. The condensable gas, which is the origin of the bio-oil is mainly composed of aldehydes, phenolic compounds, and ketones as well as large amounts of carboxylic acids, sugars, alcohols, furans, ketones, guaiacols, and syringols. It is a complex mixture and can contain up to hundreds of different compounds (4).

The technologies for conversion of this oil to transportation fuel are still under development. In Sweden, pyrolysis oil from the Pyrocell, owned by Setra and Preem, is mixed into fossil raw oil and fed to an existing catalytic cracker at the Preem refinery at the west coast of Sweden. However, for technical reasons only a small portion, up to 5%, of the total flow to the cracker could be replaced by pyrolysis oil. The yield from refining of pyrolysis oil mixed into fossil raw oil is relatively poor and the output from the pyrolysis oil fraction is mostly char and gas, not so much liquid fuel compared to fossil raw oil (15). Honeywell UOP is marketing this technology as Optimix™GF Feed (16). However, higher figures of replacement of oil have been reported, up to 10% have been tried in an FCC-reactor (Fluid Catalytic Cracker) (17).

A higher yield will require treatment with hydrogen (hydrodeoxygenation), which has turned out to be quite difficult in practice. UOP has tried this around year 2010, but abandoned this due to technical difficulties (15).

Other components in pyrolysis oil also need to be reduced in order to enhance the possibilities to upgrade the oil to commercial products. Metals, acid, or phosphor content can be removed, but the processes are still in the research stage (17).

Vow ASA, the supplier of the electrical Biogreen process, have not seen any demand for pyrolysis oil when now marketing their process (6).

Another option for the use of biooil instead of refinery upgrading is replacing bunker oil / heavy fuel oil. In a current EUDP project Stiesdal is examining the possibilities of creating a biocrude pyrolysis oil with minimal upgrading to be used for start-up burner oil in power plants or as bunker oil replacement in ship two-stroke engines.

The technologies for conversion of bio-oil (pyrolysis oil) are currently at a Technology Readiness Level (TRL) of 5, i.e. somewhere between early development and technology demonstration (18). The Dutch company BTG have plans for building a demonstration plant for upgrading of pyrolysis oil from fast pyrolysis based on experience from their pilot plant. This technology includes multiple steps of catalysis whereof one is a hydrotreatment catalyst. In a Danish context, Stiesdal, Haldor Topsøe, and Ørsted will build an upscaled bio-oil production demonstration plant as part of an ongoing EUDP project.

A lot of research is conducted regarding this subject, e.g. for oil from fast pyrolysis of straw via hydrodeoxygenation (19). Catalysts, like zeolites, can be used to reduce moisture content, remove oxygen, and crack heavy aromatic compounds to produce smaller structures (7).

Pyrolysis gas

In nearly all smaller slow pyrolysis plants pyrolysis gas formed is used for heating the main pyrolysis process. The gas (either the complete raw gas or the remaining gas after separation of oil) is combusted completely, and the released heat is partly used in the pyrolysis reactor, partly for e.g. drying or other purposes. After

leaving the reactor the flue gas will still contain heat, which can be utilized for e.g. drying of incoming biomass and/or used for generation of hot water for district heating.

In industrial-size pyrolysis plants a small fraction of the pyrolysis gas may be used for process heating, unless electric heating frees up the entire amount of pyrolysis gas for external use.

The main components in the gas are CO₂: 35 - 50 %, CO: 15 – 30 %, CH₄: 8 -15 %, H₂: 4 – 14 %, N₂: 0 – 12 %. In addition, the gas consists of a variety of hydrocarbons and other gaseous components. The composition is highly dependent on whether air is used in the reactor or not, other factors having an impact are pyrolysis temperature, type of feedstock and type of reactor.

Note that this gas composition differs a lot from natural gas which mainly consist of methane, ethane and other components having a higher heating value than the components in pyrolysis gas.

In case a surplus of gas is produced, which e.g. could be the case if the pyrolysis process is heated by electricity, the gas can be utilised for various purposes. The hot pyrolysis gas can be used directly in industrial processes, as boiler fuel and used for steam production, cooled pyrolysis gas can be used for electricity production via a specially designed gas turbines or gas motors, or it can be upgraded to other products via different process steps. However, this would require a rather large-scale unit to be economically interesting. One option is to heat the gas to around 1000 °C, thereby cracking all long hydrocarbon chains and delivering a synthesis gas that can be used for subsequent synthesis of e.g. methanol.

Energy Balance

Heating the feedstock to pyrolysis temperature requires an energy input in the form of heat. Furthermore, heat is also required for vaporization of the residual water in the feedstock. Therefore, from a pyrolysis point of view, it is important to feed the process with as dry material as possible. However, energy for drying will have to be added in a separate drying step in case the feedstock is wet. In case of using digestate, a dewatering press or similar will also be needed.

In the pyrolysis process itself both exothermic and endothermic reaction occurs, i.e. both reactions releasing and consuming energy. However, the overall process is almost thermoneutral.

For design purposes one may neglect the heat of reaction for the pyrolysis process, but it is necessary to calculate the energy required for vaporization of products and for heating of feedstock gases and char to the pyrolysis temperature (20).

The energy balance for the slow pyrolysis process of straw and digestate is shown in figure 3 and figure 4, respectively. Note that it is assumed that the energy needed for heating the pyrolysis process is taken from combustion of a part of the gas generated during the pyrolysis, this is approximately 9-13 % of the incoming energy in the feed. Note that the gas either can be taken out for combustion after or before the separation of oil fraction. Carbofex use the raw gas for combustion to provide the heat input needed for the pyrolysis process (21).

Heat required for drying of the feedstock and energy needed for e.g. pressing, is not included in the balance, but can require quite substantial amounts of energy depending on incoming moisture content. Electricity needed for running of the equipment is also not included. The losses include the cooling needed for condensation of all water vapor evaporated and formed during the pyrolysis process as well as other thermal losses.

In the two main examples presented in this report different pre-treatments are required. For straw, drying, and pelletizing is included and for digestate dewatering by means of a screw press and subsequent drying is included.

For straw: Drying (heat) approx. 11 kWh/ton (drying from 13 to 10 % moisture content) and for pelletizing approx. 23 kWh/ton as electricity.

For digestate: Dewatering screw press approx. 3 kWh/ton as electricity and drying (heat) approx. 130 kWh/ton (drying from 50 to 20 % moisture content).

If using electricity for the pyrolysis process itself the energy output in form of the total sum of products will of course be higher.

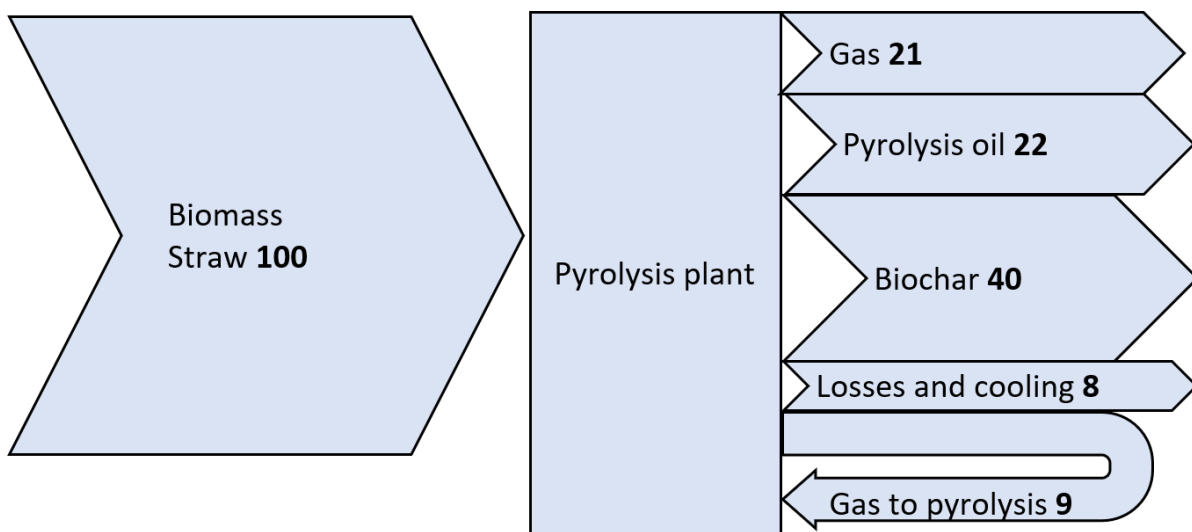

Figure 3. Example of energy balance for slow pyrolysis of straw, 10% incoming moisture content. All inputs sum to 100 units. Note, the balance shows the core process only. Assumed pyrolysis temperature is 550-600°C.

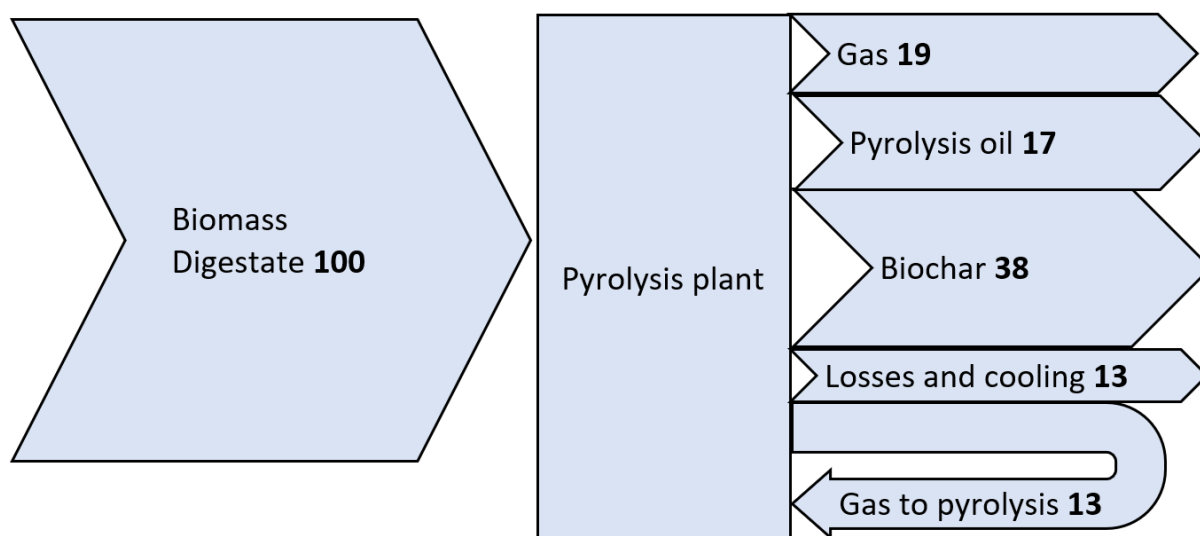

Figure 4. Example of energy balance for slow pyrolysis of digestate from biogas production, 20% incoming moisture content. All inputs sum to 100 units. Note, the balance shows the core process only. Assumed pyrolysis temperature is 550-600°C.

Part of the heat generated can be used for heating purposes if the pyrolysis plant is co-located with other industries or e.g. a district heating system. Some of the energy shown as "Losses and cooling" could then be utilized.

Carbon balance

The carbon balance, shown in table 3, is made based on general data of the carbon content in the biomass, where straw has a carbon content of 48 % (w/w) of the dry, ash-free input and digestate has a carbon content of 57 % (w/w). The carbon content for biochar and pyrolysis oil is set to 83 and 70 % (w/w), respectively. The balances for straw and digestate end up differently due to the different properties of the feed material, where moisture content has the largest impact.

Stream	Straw, C, weight %	Digestate, C, weight %
Biomass infeed	100	100
Biochar	50	37
Pyrolysis oil	19	16
Gas	22	28
Flue gas*	9	19

Table 3: Carbon balance for the slow pyrolysis process based on straw and digestate. *Some gas is combusted to keep the pyrolysis process hot, the carbon in that gas will end up in the flue gas, mainly as CO₂.

Typical Capacities

Most existing pyrolysis plants have relatively small capacities compared to biomass boilers or other industrial plants using this kind of biomass as feedstock. The typical size of a larger biomass boiler is 100-500 MW. Biogreen/Vow ASA is planning for a plant using wood as infeed, with an input capacity of approximately 30 - 40MW (6). Carbofex is planning for a plant of approx. 14 MW (21).

The first two Stiesdal SkyClean pilot plants have input capacities of 200 kW and 2 MW, respectively. The first commercial plant is expected to have an input capacity of 20 MW.

Slow pyrolysis plant that only produces biochar are available in the range from farm size (few kW) up to around 40 MW.

In general, the size/capacity of a plant will be dependent on local conditions such as type of feedstock, transportation distances, and possible integration options with other industries or communities.

Regulation Ability

Pyrolysis is considered a flexible process since the distribution of products changes as the operational parameters are changed. The most important parameter for the yield and quality of the biochar and for the yield of gas and pyrolysis oil is the pyrolysis temperature, defined as the maximum temperature in the reactor, see figure 2 above. Longer residence times and low heating rate ($^{\circ}\text{C}/\text{min}$) also increase the biochar yield and lower the yield of gasses (4). A low heating rate could be achieved by decreasing the flow of biomass and increasing the particle size, however this would be dependent of the reactor configuration and other technology-specific parameters.

A slow pyrolysis plant should be operated in continuous mode, around the clock, between maintenance shutdowns, there are several reasons for this.

- Many stops and start-up sequences increase the wear of the plant and thereby the maintenance need.
- The quality of the products will be affected by the changed operating conditions during start and stop.
- For some technologies a fossil fuel is needed to heat the process prior to start-up.
- Usually, the emissions will increase during start up and shutdown.
- If the plant is connected to a district heating system or similar, the feed of hot water to that system will be uneven.

Depending on technology the regulation ability varies, the Biogreen electrical pyrolysis have a very broad operating window, nearly 0 to 100% (6), whereas Carbofex report that there is a minimum capacity, however quite low (21).

There might be other equipment in the total system than the pyrolysis core process that sets minimum capacity, however such limitations could be mitigated by doubling of certain equipment, introducing recycle streams, etc.

Space Requirement

In previous studies made by COWI a 6 MW plant (input energy) for a Biogreen/Vow ASA -plant required a footprint of approximately 35 m x 18 m. This included pyrolysis equipment, equipment for generation of district heating, and flue gas cleaning. In addition, space will be required for storage of feedstock and product, pre-treatment equipment, infrastructure, and buildings for personnel etc.

Stiesdal informs that its 20 MW commercial plant will have a total footprint of approximately 40 m x 50 m, including drying and pelletizing.

Advantages/disadvantages

The advantage of slow pyrolysis compared to fast pyrolysis is the large output of biochar, if that is considered as the main product. Also, in general, slow pyrolysis plants have a relatively high degree of flexibility in feedstock input.

The pyrolysis process itself can be considered a robust technology at least for the types proven in larger scale. However, the practical execution of the technology is not easy and new technology suppliers delivering these kinds of processes often run into operation and maintenance problems needed to be solved prior to commercializing. Such challenges can be tar formation/pluggage, material problems/corrosion, and issues with control and automatic safety systems, mainly in the systems handling the produced gas.

As for all plants handling combustible, and potentially explosive, material the risks must be taken seriously and be mitigated as far as possible. Corrosion, plugging, leakages and other sources of risks must be handled in a structured manner. This is especially important for new technologies and when scaling up from e.g., a pilot plant to a commercial scale.

Tar is a black liquid with a high viscosity consisting of condensed hydrocarbons often found in colder sections of the process. Systems required to separate tars from gas are likely more expensive and complicated than standard cleaning systems (4).

As described in the section regarding pyrolysis oil, the commercialization of upgrading technologies is still quite far away, but there are many drivers for an increased pace in the development.

It is advantageous to locate plants for slow pyrolysis of biomass close to the biomass source, e.g. at biogas plants, since transportation of the feedstock is more expensive than return-transportation of pyrolysis products.

Environment

From a GHG-emission perspective the net emissions will be negative in case the biochar produced will be used for soil improvement. If used as replacement for e.g. fossil fuel used in other industries the net emissions will be zero, but will be positive when taking into account the case where fossil fuels are used for farming and transportation. See also the section regarding biochar above. It has been reported that the value of the CO₂-sequestration is 870 DKK/ton biochar over a period of 20-years (22). In a Danish context biochar will be counted as negative emissions (23) if the biochar is plowed down into agricultural mineral soils (31).

The overall net emissions will generally depend on the type of fuel used for farming, transportation, and on whether the electrical energy used is generated without using fossil fuels as well as whether the use of feedstock involves using straw and manure that would otherwise have led to increased carbon storage when applied to mineral soils.

Polycyclic aromatic hydrocarbons (PAHs), which are considered hazardous to the environment, are formed in the pyrolysis process and is found in the biochar. The formation depends on many variables, out of which the pyrolysis peak temperature is the most important (however this is debated in (23)), with a higher temperature leading to a lower PAH-content. However, reactor pressure and gas residence time are also of some importance (24). A maximum content of PAH's for basic grade biochars according to the European Biochar initiative is 12 mg/kg. The concentration can vary between 0,1 to over 10 000 mg/kg depending on raw material, pyrolysis maximum temperature, vaporization rate etc.

Trials show that straw-derived biochar contained 5,8 times higher PAH concentrations than wood-derived and that the reactor design and presence of a carrier gas in the reactor influence the formation of PAH (23).

Stiesdal reports that the PAH content in biochar produced by the pyrolysis process is less than 1 mg/kg. According to Stiesdal the PAH levels in biochar is mostly dependent on the actual design of the pyrolysis plant and can be mostly eliminated by proper design. It is important that the discharge of biochar is cooled in an atmosphere free from pyrolysis gas so that the PAH cannot condensate on the char (27).

There will always be emissions to the air from a pyrolysis plant. Combustion of pyrolysis gas for heating of the pyrolysis process or in another parts of the plant will lead to emissions through the outlet for flue gas from the plant. This flue gas would most likely have to comply with the same legislation as regular biomass boilers, e.g. regarding SO₂, NO_x and dust particles emissions. At least some kind of filter or electrostatic precipitator will be needed and, depending on the demands, also possibly flue gas condensation. The water from such a condensation would need to be neutralized. Approximately 50% of the chlorine in the biomass will be found in the gas as HCl (4). It can also be mentioned that measurements of emissions of greenhouse gases from plants producing biochar may be needed for the national greenhouse gas emission account system to be able not to use IPCC default emission factor values (31).

Water will be required for cooling and wetting, or in some cases quenching, of the biochar. Furthermore, water will be used for cooling of the pyrolysis gas and for other parts of the process, depending on the setup of the plant. During quenching the steam formed can contain several contaminants such as H₂S, NO_x, CO₂, CO and H₂ and leave the plant as a contaminated water stream.

Research and Development Perspectives

As noted in previous sections, the slow pyrolysis is an emerging technology with a large potential. The knowledge and practical use of pyrolysis can be considered as a mature technology; however, all new suppliers will have a learning curve when it comes to scaling up the process.

Upgrading of pyrolysis oil and gas to drop-in fuels which can be used in the existing infrastructure, is still in a developing phase and not yet commercially available.

Examples of Market Standard Technology

For slow pyrolysis plants aiming for a combined production of biochar, pyrolysis oil, and combustible gas only the Stiesdal SkyClean, the Biogreen process -owned by Vow ASA in Norway and the Finnish company Carbofex are available. The Stiesdal technology has been proven at the 200 kW pilot plant, and large-scale

demonstration has commenced at the 2 MW demonstration plant. The first fully commercial plant is planned for installation in H1 2023.

Vow ASA / Biogreen have several plants in operation using an electrical heated screw conveyor as pyrolyser unit and are broadly marketing their technology for production of biochar, gas and possibly oil for various applications and industries (6). The maximum capacity for one single screw conveyor is approximately 1500 kg/h, or 6 MW input in feedstock. They have delivered in total 14 plants for production of biochar, in the range between 10 to 2000 kg/h, and several more for other purposes, as valorisation of plastic and waste.

Carbofex is in the progress of scaling up their technology from feed input of 500 kg/h to 2,5 ton/h. They use an indirectly heated screw conveyor for the pyrolysis (21).

For production of biochar as single product there are numerous technology providers providing proven technology with numerous reference plants. These suppliers have equipment and plants from small-scale, comparably simple, units used e.g. at single farms up to larger industrial scale facilities.

Examples of suppliers of large-scale slow pyrolysis plants are Pyreg, Biomacon, Splaniex and Biogreen.

Plants aiming for a high yield of pyrolysis oil normally use fast pyrolysis and plants aiming for production of syngas use gasification as means to make the most efficient process. These technologies are not further described in this document. Further information regarding these technologies can be found in other chapters of the technology catalogue.

Prediction of Performance and Costs

The data used for prediction of capital and operating costs in the data sheet is based on preliminary figures and estimates. The most certain figures regarding investment cost are based on the Biogreen concept.

Uncertainty

Given the lack of commercial development and the rapid development it is hard to predict the investment and operating cost of a future full scale production facility. Classifying the cost estimate this will be a class 5 estimate on the AACE-scale (25).

Quantitative description

Energy/Technical Data

Typical Plant Size

No typical plant sizes can be stated since there are no real commercial plants yet combining production of biochar, pyrolysis oil, and gas. The plant size would likely be depending on transportation cost and logistics for the incoming feedstock.

This study is based on a plant size of 20 MW input for straw or digestate, which is approximately 110 ton of feedstock per day if straw pellets are used as feedstock. The size of the plant for digestate pyrolysis is set to the same feed rate of wet biomass on mass basis, which corresponds to approximately 18 MW input. This is

equivalent to 37 kton/year, assuming 8000 hours of operation annually. This size is chosen based on the size presented in the SkyClean report from EA Energianalyse in 2020 (22) and is also in the range of planned plant sizes from Biogreen/Vow ASA and Carbofex. Costs for pretreatment is included in the calculations.

Input and Output

The input and output for a 37 kton/year input plant is shown in the tables below, operating time set to 8000 h/year. The difference between mass input and output is mainly the water (in the incoming feed and formed in the process) and the flue gas components after gas combustion needed to feed the process with heat energy.

	Unit	Input	Output
Straw pellets, 10% moisture	kton/year	37	
Biochar	kton/year		9.8
Pyrolysis oil	kton/year		4.1
Gas	kton/year		11

Table 4. Typical Input and Output for straw pyrolysis. Note the feedstock is pretreated and dried to 10% moisture content. For original moisture content, see table 1.

	Unit	Input	Output
Digestate, 20% moisture	kton/year	37	
Biochar	kton/year		8.8
Pyrolysis oil	kton/year		3.7
Gas	kton/year		8.9

Table 5. Typical Input and Output for digestate pyrolysis. Note the feedstock is pretreated and dried to 20% moisture content. For original moisture content, see table 1.

The size of these two plants is set equal in the economical calculations, however the outcome in specific outputs and energy consumption differs.

Forced and Planned Outage

Biogreen/Vow ASA says their pyrolysis equipment require a regular short maintenance stop every 30th day, and two longer stops per year, 2 and 5 days (6). This seems like fair figures for a standard, developed technology. However unplanned stops will be a part of the scaling up and commercializing process as for all new technologies in this field of technology.

Technical Lifetime

20 – 25 years is a typical figure when designing these kinds of plants. The lifetime can be prolonged by replacing worn-out equipment and having a structured maintenance plan.

Construction Time

For a large complex unit including treatment of pyrolysis oil and possibly upgrading of the syngas the construction period, from investment decision to continuous operation will be 2-3 years. This is a typical time schedule for larger thermochemical production facilities.

For a single pyrolysis unit, the construction time will be shorter, Biogreen/Vow ASA claims that 9 months is sufficient (6). However, considering that infrastructure, additional process areas like biomass pelletizing / drying, control rooms etc. will be needed, at least 1.5 years seems more reasonable.

Financial Data

Investment Costs

Based on rough figures from Stiesdal, Carbofex and Vow/Biogreen and using a scale up formula the investment cost has been estimated to 21 MEuro for the typical plant described above. This figure includes pretreatment, the pyrolysis plant itself including separation of gas and pyrolysis oil. Cost for any upgrading of pyrolysis oil and gas are not included in this figure.

Operation and Maintenance (O&M) Costs

The fixed cost for operation and maintenance is set as a percentage of the investment cost, including pretreatment.

The variable cost for operation and maintenance is based on 185 DKK per ton of straw, which is assumed to be equal for digestate (22).

Start-up Costs

The start-up costs are included in the operating cost estimates.

Technology Specific Data

The figures calculated for straw and digestate is presented in the table below, see also table 1 for information regarding properties of the raw materials. These figures shall be used with care since they vary depending on e.g., type of pyrolysis process and variations in the feedstocks.

Parameter	Unit	Pyrolysis of straw	Pyrolysis of digestate
Specific energy content	GJ/ton biochar	25	27
Specific bulk density of biochar	ton/m ³ biochar	0.16 – 0,30	0.25 – 0,40
Specific density of biochar	ton/m ³ biochar	0.3 – 0.6	0.5 – 0.7
LHV of biochar	MJ/kg ash free	25	27
Specific energy content of pyrolysis oil	GJ/ton pyrolysis oil	33	24
Specific density of pyrolysis oil	ton/m ³ pyrolysis oil	1.1	1.1
LHV of pyrolysis oil	MJ/kg ash free	31	23.5
Specific energy content of pyrolysis gas	MJ/Nm ³ pyrolysis gas	13	16
Specific density of pyrolysis gas	kg/Nm ³	1.4	1.4
LHV of pyrolysis gas	MJ/kg	10.3	10.7

Table 6. Properties of the product fractions from slow pyrolysis of straw and digestate at 600°C.

Data sheets

See Attachment 1, data sheet in excel-format.

References

1. An economic analysis of anaerobic digestate fuel pellet production. Cathcart, A. 2021, Cleaner Engineering and Technology 3.
2. Energiforsk. Bränslehandboken (Fuel handbook). s.l. : Energiforsk Sweden, 2012.
3. Biochar and Energy Production: Valorizing swine manure through coupling co-digestion and pyrolysis. Gonzales, Ruben. 43, s.l. : Journal of carbon research, 2020, Vol. 6.
4. Hemlin, Hanna. Production of biochar through slow pyrolysis of biomass: Peat, straw, horse manure and sewage sludge. Stockholm : KTH Royal institute of technology, 2018.
5. Chowdhury, Zaira. Pyrolysis: A sustainable Way to Generate Energy from Waste. s.l. : IntertechOpen Book Series, 2017. DOI: 10.5772/intertchopen 69036.
6. Current status of the pyrolysis and gasification mechanism of biomass. Glushkov, Dmitrii. s.l. : MDPI / Energies, 2021, Vol. 14.
7. Allaire, Suzanne. Analyses of biochar properties. Quebec : Universite Laval, 2015.
8. EBC. European Biochar Certificate - Guidelines for a sustainable Production of Biochar. Arbax, Switzerland : European Biochar Foundation (EBC) (<http://european-biochar.org>), 2012-2022. Version 10.1 from Jan 2022.
9. Carbon standards international. [Online] 2022. <https://www.carbon-standards.com/en/home>.
10. Paulsson, Marcus. Rest till bäst, sammanfattande slutrapport. Lund : biokol.org, 2020. <https://biokol.org/slutrappport-steg-2/>.
11. <https://skanefro.se/>. [Online] Skånefrö, December 2021.
12. Ritzen, Adam. Vow ASA, Business development. s.l. : Personal Teams meeting, December 14, 2021.
13. Soil Organic Carbon Sequestration after biochar application: Aglobal meta-analysis. Gross, Arthur. s.l. : Agronomy, December 2021, Vol. 11.
14. Energiforsk. Proveldning av pyrolysolja för kraftvärmeproduktion. Sweden : Energiforsk, 2016.
15. Furusjö, Erik. Researcher at RISE Research Institute of Sweden. Personal interview. December 2021.
16. <https://uop.honeywell.com/en/news-events/2021/september/honeywell-and-preem-conduct-commercial-co-processing-trial-to-produce-renewable-fuel>. [Online] Honeywell, 2021.
17. Fast pyrolysis oil from pinewood chips co-processing with vacuum gas oil in an FCC unit for second generation fuel production. Pihno, Andrea de Ezende. s.l. : Elsevier, 2017, Vols. 188, pages 462-473.
18. Hultgren, Anders Edling, CEO Voiton Biorefineries. s.l. : Personal interview, February 02, 2022.
19. Energiforsk, Sweden. Pyros -roadmap for realization of a value chain from forest to biofuels via bio-oil. s.l. : Energiforsk, 2018.
20. Quantitative Study of Straw Bio-oil Hydrodeoxygenation over a Sulfided NiMo Catalyst. Auersvald, Milos. 7, s.l. : ASC Publications, Sustainable Chemical Engineering, 2019.
21. Basu, Prabir. Biomass Gasification and Pyrolysis Practical Design. s.l. : Academic Press, 2010. ISBN 978-0-12-374988-8.
22. Sampo Tukainen, Carbofex. e-mail conversation. 2021.

23. EA Energianalyse. Pyrolyse af halm og nedmuldning af biokul som klimavirkemiddel. København : EA Energianalyse, 2020.
24. Hoffmann, Anders. afd. chef KEFM.
25. Strategies for producing biochars with minimum PAH contamination. Buss. Edinburgh : Journal of analytical and applied pyrolysis, 2016.
26. Importance of pyrolysis temperature and pressure in concentration of aromatic hydrocarbons in wood waste-derived biochars. Greco, Gianula. s.l. : Journal of Analytical and Applied Pyrolysis, 2021, Vol. 159.
27. Stiesdal, Henrik. Comment to this report. 2022.
28. international, AACE. Cost estimate classification system - as applied in engineering, procurement and construction for the process industries. 2011.
29. Application of biogas digestate as solid fuel. Kraitzeisen, Martin. 9, s.l. : Elsevier, 2010, Vol. 89.
30. <https://dca.au.dk/aktuelt/nyheder/vis/artikel/opstartsseminar-videnssyntese-om-anvendelse-af-biokul-i-dansk-landbrug/>.
31. https://dce.au.dk/fileadmin/dce.au.dk/Udgivelser/Notater_2022/N2022_15.pdf.