

Technology Data for Energy storage

First published: November 2018

Latest update: August 2019

Version number: 0003

Danish Energy Agency

Amaliegade 44
DK-1256 Copenhagen K

P: +45 3392 6700
E: ens@ens.dk

www.ens.dk

AMENDMENT SHEET

Publication date

Publication date for this catalogue “Technology Data for Energy Storage” is October 2018. This amendment sheet has been added and also the possibility to add descriptions of amendments in the individual chapters if required. Hereby the catalogue can be updated continuously as technologies evolve, if the data changes significantly or if errors are found.

The newest version of the catalogue will always be available from the Danish Energy Agency’s web site.

Amendments after publication date

All updates made after the publication date will be listed in the amendment sheet below.

Date	Ref.	Description
August 2019	142	Updated chapter for small scale hot water storage tank
March 2019	180, 183	Minor corrections to the Lithium ion battery and the Na-NiCl ₂ chapters
February 2019	180, Front page	Small corrections to the Lithium ion battery datasheet implemented. Version number added to front page
January 2019	180	Lithium ion battery chapter added
December 2018	160, 180, 181, 182, 183	Formatting and internal references fixed in CAES chapter Added chapters on VRB-, Na-S- and Na-NiCl ₂ batteries Previous battery chapter removed
November 2018	140 Seasonal Heat Storage, 141 Large-scale Hot Water Tanks, 161 CAES	Updated chapters on Seasonal Heat Storage and Large-scale Hot Water Tanks Updated chapter on CAES Small update to the Introduction and Electricity Storage chapters
October 2018	142 Small-scale Hot water tanks, 150 Underground storage of gas, 151	Chapters transferred from previous Technology Data Catalogue for Electricity and district heating production from May 2012

	Hydrogen storage, 160 PHS, 161 CAES and 180 Batteries	
--	-------------------------------------------------------------	--

PREFACE

The *Danish Energy Agency* and *Energinet*, the Danish transmission system operator, publish catalogues containing data on technologies for Energy Storage. This is the first edition of the catalogue. This catalogue includes updates of a number of technologies which replace the corresponding chapters in the catalogue for Energy Plants published in May 2012. The catalogue will continuously be updated as technologies evolve, if data change significantly or if errors are found. All updates will be listed in the amendment sheet on the previous page and in connection with the relevant chapters, and it will always be possible to find the most recently updated version on the Danish Energy Agency's website.

The primary objective of publishing technology catalogues is to establish a uniform, commonly accepted and up-to-date basis for energy planning activities, such as future outlooks, evaluations of security of supply and environmental impacts, climate change evaluations, as well as technical and economic analyses, e.g. on the framework conditions for the development and deployment of certain classes of technologies.

With this scope in mind, it is not the target of the technology data catalogues, to provide an exhaustive collection of specifications on all available incarnations of energy technologies. Only selected, representative, technologies are included, to enable generic comparisons of technologies with similar functions in the energy system e.g. thermal gasification versus combustion of biomass or electricity storage in batteries versus fly wheels.

Finally, the catalogue is meant for international as well as Danish audiences in an attempt to support and contribute to similar initiatives aimed at forming a public and concerted knowledge base for international analyses and negotiations.

DANISH PREFACE

Energistyrelsen og Energinet udarbejder teknologibeskrivelser for en række energilagringsteknologier. Dette er den første udgave. Kataloget indeholder opdateringer af teknologier, som erstatter de tilsvarende kapitler i kataloget for el og fjernvarme, som blev udgivet i 2012. Kataloget vil løbende opdateres i takt med at teknologierne udvikler sig, hvis data ændrer sig væsentligt eller hvis der findes fejl. Alle opdateringer vil registreres i rettelsesbladet først i kataloget, og det vil altid være muligt at finde den seneste opdaterede version på Energistyrelsens hjemmeside.

Hovedformålet med teknologikataloget er at sikre et ensartet, alment accepteret og aktuelt grundlag for planlægningsarbejde og vurderinger af forsyningssikkerhed, beredskab, miljø og markedsudvikling hos bl.a. de systemansvarlige selskaber, universiteterne, rådgivere og Energistyrelsen. Dette omfatter for eksempel fremskrivninger, scenarieanalyser og teknisk-økonomiske analyser.

Desuden er teknologikataloget et nyttigt redskab til at vurdere udviklingsmulighederne for energisektorens mange teknologier til brug for tilrettelæggelsen af støtteprogrammer for energiforskning og -udvikling.

Tilsvarende afspejler kataloget resultaterne af den energirelaterede forskning og udvikling. Også behovet for planlægning og vurdering af klima-projekter har aktualiseret nødvendigheden af et opdateret databeredskab.

Endeligt kan teknologikataloget anvendes i såvel nordisk som internationalt perspektiv. Det kan derudover bruges som et led i en systematisk international vidensopbygning og -udveksling, ligesom kataloget kan benyttes som dansk udspil til teknologiske forudsætninger for internationale analyser og forhandlinger. Af disse grunde er kataloget udarbejdet på engelsk.

TABLE OF CONTENTS

Amendment sheet	2
Preface	4
Danish preface	4
Table of contents	6
Introduction.....	7
Electricity Storage	26
140 Seasonal Heat Storage	36
141 Large-scale Hot Water Tanks	53
142 Small-scale Hot Water Tanks	61
150 Underground Storage of Gas	68
151 Hydrogen Storage	72
160 Pumped Hydro Storage	75
161 Compressed Air Energy Storage.....	78
162 Flywheels	99
180 Lithium-ion batteries for grid-scale storage	117
181 Vanadium Redox Flow Battery	143
182 Na-S battery	159
183 Na-NiCl ₂ batteries	177

INTRODUCTION

This catalogue addresses technologies for energy storage. The focus is on the specific storage technology. Therefore, its interaction with the system and the combination with other technologies is not always considered. For example, hydrogen storage will be described as a gas storage system and not as a potential mean to store electricity. Each storage unit is defined by its energy carrier such that the boundary to the energy system is the input and output of this same energy carrier. For example, while a flywheel stores kinetic energy, it is in this catalogue for all intend and purposes defined as an electricity storage. Therefore, the conversion from electricity to kinetic energy and back again is included in the storage technology. Likewise, when defining the boundaries of an ATEs a heat pump is not included in the storage since ATEs is defined as a heat storage while the heat pump requires an external energy source - usually in the form of electricity or steam.

Each chapter contains the necessary qualitative description and quantitative data to complete the storage of the energy carrier. The exact system boundaries and energy carrier being stored is defined for each technology in the qualitative description.

The main purpose of the catalogue is to provide generalized data for analysis of energy systems, including economic scenario models and high-level energy planning.

These guidelines serve as an introduction to the presentations of the different technologies in the catalogue, and as instructions for the authors of the technology chapters. The general assumptions are described in section 1.1. The following sections (1.2 and 1.3) explain the formats of the technology chapters, how data were obtained, and which assumptions they are based on. Each technology is subsequently described in a separate technology chapter, making up the main part of this catalogue. The technology chapters contain both a description of the technologies and a quantitative part including a table with the most important technology data.

General classification

Since there are different forms of energy stored and different possible applications of certain technologies, these are categorized as shown in the following table.

The possible forms of energy stored are electricity, heat or gas. The applications are divided into system or local level. While the former includes large scale technologies to provide system services, the latter refers to household level or other smaller size applications.

The table only lists the technologies included in the catalogue.

		Application	
		System level	Local level
Form of energy stored	Electricity	Flywheel (FES) Large Batteries (NaS, VRB, SoNick) Stationary lithium-ion batteries	Lead-acid batteries Flywheel (FES) Stationary lithium-ion batteries Electric car batteries
	Heat	Seasonal Heat storage – Water pits Aquifer thermal energy storage (ATES) Large Scale Hot Water tank	Small scale hot water tank
	Gas	Underground natural gas storage (caverns and aquifer) Hydrogen Storage above ground Hydrogen Storage in caverns	Compressed hydrogen storage

Technologies for electricity storage are further divided into power-intensive storage services and energy-intensive storage services. See section 1.4 for definitions.

The table below shows a categorization of electricity storage technologies.

Technology	Service provided	
	Power-intensive	Energy-intensive
Flywheel (FES)	✓	✓
Large Batteries (NaS, VRB, SoNick)	✓	✓
Lead-acid batteries		✓
Stationary lithium-ion batteries	✓	✓
Electric car batteries		✓

1.2. Qualitative description

The qualitative description covers the key characteristics of the technology as concise as possible. The following paragraphs are included where relevant for the technology.

Contact information

Containing the following information:

- Contact information: Contact details in case the reader has clarifying questions to the technology chapters. This could be the Danish Energy Agency, Energinet.dk or the author of the technology chapters.
- Author: Entity/person responsible for preparing the technology chapters
- Reviewer: Entity/person responsible for reviewing the technology chapters.

Brief technology description

Brief description for non-engineers of how the technology works and for which purpose. This includes the form of energy stored, any potential storage medium and the application of the technology, as mentioned in the table in the introduction. Moreover, the type of services that the storage technology can provide is expressed (e.g. storage for production plants, primary frequency regulation, load shifting, etc.)

The system boundaries are identified in this section. In cases where the conversion units are not parts of the system, examples of typical conversion technologies used with the storage unit are mentioned such as heat pumps for ATEs systems etc.

An illustration of the technology is included, showing the main components and working principles.

Input/output

The form of energy input to be stored (electricity, hot water, natural gas etc.) and the output(s).

Energy efficiency and losses

The energy conversion efficiency

- Charge/discharge efficiency
- Round-trip efficiency

and energy losses such as idle losses, self-discharge (batteries), heat loss, mechanical loss, etc.

Regulation ability and other system services

Mainly relevant for electricity storage technologies, i.e. how fast can they start up and how quickly are they able to respond to demand changes (response time) or provide grid services. For electricity storage

technologies, especially if suitable for power intensive application, the qualitative description includes the technology's capability for delivering the following power system services:

- Inertia
- Short circuit power
- Black start
- Voltage control
- Damping of system oscillations (PSS)

Typical characteristics and capacities

The characteristics are stated for a single unit capable of providing the storage service needed. In the case of modular technologies such as batteries, the unit is represented by a typical size of battery installation, to provide the service described.

The typical characteristics expressed are:

- Energy storage capacity, in MWh: amount of energy that can be stored
- Input and output capacities, in MW: rate at which the energy can either charge or discharge
- Energy density and specific energy, in Wh/m³ and Wh/kg respectively

Beside electricity, the units MW and MWh are used for heat and gas as well. While this is not in accordance with thermodynamic formalism, it makes comparisons easier and provides a more intuitive link between capacities, production and full load hours.

For some storage technologies, there is a certain amount of energy that has to be constantly kept in the storage unit to ensure low degradation or to maintain specific conditions (e.g. pressure, temperature).

For example, in electrical batteries there could be a lower bound for the state of charge (SOC) and for gas storage in caverns a certain amount of cushion gas is normally required. In such cases, only the "active storage capacity" is specified, meaning the amount of energy between maximum and minimum level. Information regarding the minimum required amount of energy stored is also explained here.

Ranges for the different parameters could be indicated here if the technology has various typical sizes.

Typical storage period

Qualitative expression of how long the energy is typically stored in the unit, which is closely related to the application and the services provided. The storage period is typically in the range from hours or days to longer periods such as months or years.

Space requirement

The space requirement for the installation of the storage technology is expressed in m² per MWh. The space requirements may for example be used to calculate the rent of land, which is not included in the financial cost, since this cost item depends on the specific location of the plant.

Advantages/disadvantages

A description of specific advantages and disadvantages relative to equivalent technologies. Generic advantages are ignored; e.g. renewable energy technologies mitigating climate risks and enhance security of supply.

Environment

Particular environmental characteristics are mentioned, for example special emissions or the main ecological footprints.

For water reservoirs, as well as for cavern gas storage, the methane leakage is specified.

For batteries the use of critical, toxic or regulated materials is specified.

Research and development perspectives

This section lists the most important challenges to further development of the technology. Also, the potential for technological development in terms of costs and efficiency is mentioned and quantified if possible. Danish research and development perspectives are highlighted, where relevant.

Examples of market standard technology

Recent full-scale commercial projects, which can be considered market standard, are mentioned, preferably with links. A description of what is meant by “market standard” is given in the introduction to the quantitative description section (Section 1.3). For technologies where no market standard has yet been established, reference is made to best available technology in R&D projects.

Prediction of performance and costs

Cost reductions and improvements of performance can be expected for most technologies in the future. This section accounts for the assumptions underlying the cost and performance in 2015 as well as the improvements assumed for the years 2020, 2030 and 2050.

The specific technology is identified and classified in one of four categories of technological maturity, indicating the commercial and technological progress, and the assumptions for the projections are described in detail.

In formulating the section, the following background information is considered:

Data for 2015

In case of technologies where market standards have been established, performance and cost data of recent installed versions of the technology in Denmark or the most similar countries in relation to the specific technology in Northern Europe are used for the 2015 estimates.

If consistent data are not available, or if no suitable market standard has yet emerged for new technologies, the 2015 costs may be estimated using an engineering based approach applying a decomposition of

manufacturing and installation costs into raw materials, labor costs, financial costs, etc. International references such as the IEA, NREL etc. are preferred for such estimates.

Assumptions for the period 2020 to 2050

According to the IEA:

“Innovation theory describes technological innovation through two approaches: the technology-push model, in which new technologies evolve and push themselves into the marketplace; and the market-pull model, in which a market opportunity leads to investment in R&D and, eventually, to an innovation” [6].

The level of “market-pull” is to a high degree dependent on the global climate and energy policies. Hence, in a future with strong climate policies, demand for e.g. renewable energy technologies will be higher, whereby innovation is expected to take place faster than in a situation with less ambitious policies. This is expected to lead to both more efficient technologies, as well as cost reductions due to economy of scale effects. Therefore, for technologies where large cost reductions are expected, it is important to account for assumptions about global future demand.

The IEA’s New Policies Scenario provides the framework for the Danish Energy Agency’s projection of international fuel prices and CO₂-prices, and is also used in the preparation of this catalogue. Thus, the projections of the demand for technologies are defined in accordance with the thinking in the New Policies Scenario, described as follows:

“New Policies Scenario: A scenario in the World Energy Outlook that takes account of broad policy commitments and plans that have been announced by countries, including national pledges to reduce greenhouse gas emissions and plans to phase out fossil energy subsidies, even if the measures to implement these commitments have yet to be identified or announced. This broadly serves as the IEA baseline scenario.” [7].

Alternative projections may be presented as well relying for example on the IEA’s 450 Scenario (strong climate policies) or the IEA’s Current Policies Scenario (weaker climate policies).

Learning curves and technological maturity

Predicting the future costs of technologies may be done by applying a cost decomposition strategy, as mentioned above, decomposing the costs of the technology into categories such as labor, materials, etc. for which predictions already exist. Alternatively, the development could be predicted using learning curves. Learning curves express the idea that each time a unit of a particular technology is produced, learning accumulates, which leads to cheaper production of the next unit of that technology. The learning rates also take into account benefits from economy of scale and benefits related to using automated production processes at high production volumes.

The potential for improving technologies is linked to the level of technological maturity. The technologies are categorized within one of the following four levels of technological maturity.

Category 1. Technologies that are still in the *research and development phase*. The uncertainty related to price and performance today and in the future is highly significant (e.g. wave energy converters, solid oxide fuel cells).

Category 2. Technologies in the *pioneer phase*. The technology has been proven to work through demonstration facilities or semi-commercial plants. Due to the limited application, the price and performance is still attached with high uncertainty, since development and customization is still needed. The technology still has a significant development potential (e.g. gasification of biomass).

Category 3. *Commercial technologies with moderate deployment*. The price and performance of the technology today is well known. These technologies are deemed to have a certain development potential and therefore there is a considerable level of uncertainty related to future price and performance (e.g. offshore wind turbines)

Category 4. *Commercial technologies, with large deployment*. The price and performance of the technology today is well known and normally only incremental improvements would be expected. Therefore, the future price and performance may also be projected with a relatively high level of certainty. (e.g. coal power, gas turbine)

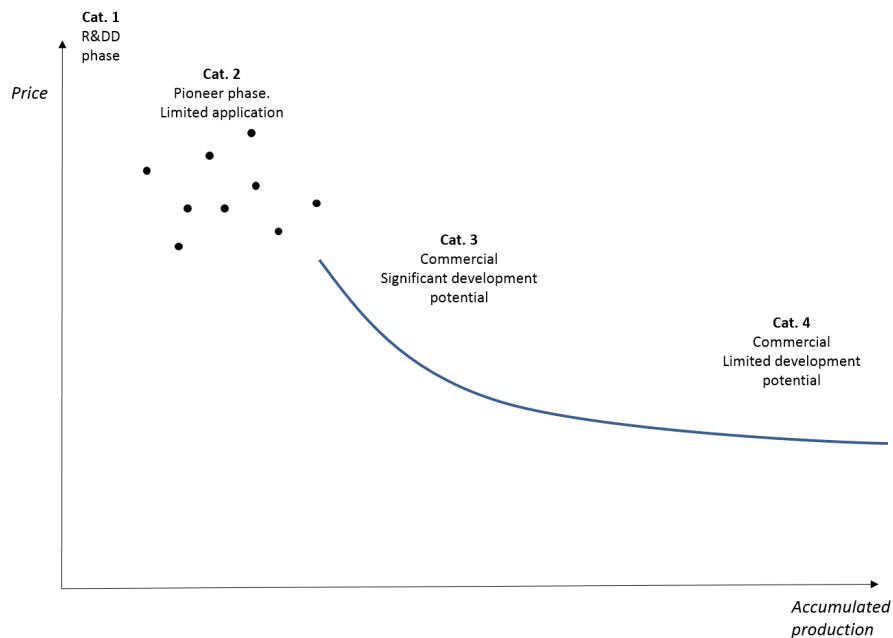

Figure 1: Technological development phases. Correlation between accumulated production volume (MW) and price.

Uncertainty

The catalogue covers both mature technologies and technologies under development. This implies that the price and performance of some technologies may be estimated with a relatively high level of certainty whereas in the case of others, both cost and performance today as well as in the future are associated with high levels of uncertainty.

This section of the technology chapters explains the main challenges to precision of the data and identifies the areas on which the uncertainty ranges in the quantitative description are based. This includes technological or market related issues of the specific technology as well as the level of experience and knowledge in the sector and possible limitations on raw materials. The issues should also relate to the technological development maturity as discussed above.

The level of uncertainty is illustrated by providing a lower and higher bound beside the central estimate, which shall be interpreted as representing probabilities corresponding to a 90% confidence interval. It should be noted, that projecting costs of technologies far into the future is a task associated with very large uncertainties. Thus, depending on the technological maturity expressed and the period considered, the confidence interval may be very large. It is the case, for example, of less developed technologies (category 1 and 2) and long time horizons (2050).

Additional remarks

This section includes other information, for example links to web sites that describe the technology further or give key figures on it.

References

References are numbered in the text in squared brackets and bibliographical details are listed in this section.

Quantitative description

To enable comparative analyses between different technologies it is imperative that data are actually comparable: All cost data are stated in fixed 2015 prices excluding value added taxes (VAT) and other taxes. The information given in the tables relate to the development status of the technology at the point of final investment decision (FID) in the given year (2015, 2020, 2030 and 2050). FID is assumed to be taken when financing of a project is secured and all permits are at hand. The year of commissioning will depend on the construction time of the individual technologies.

A typical table of quantitative data is shown below, containing all parameters used to describe the specific technologies. The table consists of a generic part, which is identical for all storage technologies and a technology specific part, containing information which is only relevant for the specific technology or the group of technologies (power, gas, heat storage). The generic part is made to allow for an easy comparison.

Each cell in the table contains only one number, which is the central estimate for the market standard technology, i.e. no range indications. Uncertainties related to the figures are stated in the columns named *uncertainty*. To keep the table simple, the level of uncertainty is only specified for years 2020 and 2050.

The level of uncertainty is illustrated by providing a lower and higher bound. These are chosen to reflect the uncertainties of the best projections by the authors. The section on uncertainty in the qualitative description for each technology indicates the main issues influencing the uncertainty related to the specific technology. For technologies in the early stages of technological development or technologies especially prone to variations of cost and performance data, the bounds expressing the confidence interval could result in large intervals. The uncertainty is related to the market standard technology; in other words, the uncertainty interval does not represent the product range (for example a product with lower efficiency at a lower price or vice versa).

The level of uncertainty is stated for the most critical figures such as investment cost and efficiencies. Other figures are considered if relevant.

All data in the tables are referenced by a number in the utmost right column (Ref), referring to source specifics below the table. The following separators are used:

; (semicolon) separation between the four time horizons (2015, 2020, 2030, and 2050)

/ (forward slash) separation between sources with different data

+ (plus) agreement between sources on same data

Notes include additional information on how the data are obtained, as well as assumptions and potential calculations behind the figures presented. Before using the data, please be aware that essential information may be found in the notes below the table.

The generic parts of the tables for storage technologies are presented below:

Technology	name/ description									
	2015	2020	2030	2050	Uncertainty (2020)		Uncertainty (2050)		Note	Ref
Energy/technical data	Lower		Upper		Lower		Upper			
Form of energy stored										
Application										
Energy storage capacity for one unit (MWh)										
Output capacity for one unit (MW)										
Input capacity for one unit (MW)										
Round trip efficiency (%)										
- Charge efficiency (%)										
- Discharge efficiency (%)										
Energy losses during storage (%/period)										
Auxiliary electricity consumption (% of output) (Expressed only for heat and gas storages)										
Forced outage (%)										
Planned outage (weeks per year)										
Technical lifetime (years)										
Construction time (years)										
Regulation ability (only for electricity storage)										
Response time from idle to full-rated discharge (sec)										
Response time from full-rated charge to full-rated discharge (sec)										
Financial data										
Total investment cost (M€2015 per MWh)										
- energy component (M€/MWh)										
- capacity component (M€/MW)										
- other project costs (M€)										
Fixed O&M (% total investment)										
Variable O&M (€2015/MWh)										
Technology specific data										
Alternative Total investment cost (M€2015 per MW)										

Energy/technical data

Energy storage capacity for one unit

The storage capacity, preferably a typical capacity (not maximum capacity), represents the size of a standard unit in terms of energy stored. It refers to a single unit capable of providing the storage service needed, e.g. a hydro plant, a heat tank or a battery installation.

In the case of a modular technology such batteries, a typical size based on historical installations or the market standard is chosen as a unit. Different sizes may be specified in separate tables, e.g. small, medium, large battery installation.

As explained under “Typical characteristics”, the energy storage capacity refers only to the active part of the storage unit, i.e. the energy that can be used, and not to the rated storage capacity of the storage. Additional information on the minimum level of energy required is found in the notes.

The unit MWh is used for electricity, heat and gas energy storage capacity.

Output and input capacity for one unit

The nominal output capacity is stated for a full unit and refers to the active part of the storage. Any other information regarding the minimum level is specified in the notes. It is given as net output capacity in continuous operation, i.e. gross output capacity minus own consumption.

The nominal input capacity is stated for a full unit as well. In case it is equal to the output capacity, the value specified will be the same.

The unit MW is used for all output and input capacities.

Charge and discharge efficiencies (round trip efficiency)

The efficiencies of the charging and discharging processes are stated separately in percent where possible.

The round-trip efficiency is the product of charging and discharging efficiencies and expresses the fraction of the input energy, which can be recovered at the output, assuming no losses during the storage period. It represents the ratio between the energy provided to the user and the energy needed to charge the storage system.

For electricity storage, it is intended as AC-AC value, therefore including losses in the converters and other auxiliaries.

The round-trip efficiency enables comparisons of different storage technologies with respect to efficiency of the storage process. However, not including the losses during the storage period, it does not give a complete picture. Losses are treated below.

Energy losses during storage

The energy lost from the storage unit due to losses in a specific time horizon is specified here.

Technologies with different storage periods will show very different behaviour with respect to energy losses. Therefore, the period is chosen based on the characteristics of the technology (e.g. % losses/hour, % losses/day or % losses/year).

Losses are expressed as a percentage of the energy storage capacity (as defined above) lost over the timeframe chosen.

Auxiliary electricity consumption

Storage systems for heat and gas usually need auxiliary systems to operate, such as pumps and/or compressor. The auxiliary consumption expresses the consumption of electricity from such equipment as a percentage of output, which has gone through the full storage cycle.

For electricity storage, this component is already included in the overall round trip efficiency (AC-AC).

Forced and planned outage

Forced outage is defined as the number of weighted forced outage hours divided by the sum of forced outage hours and operation hours. The weighted forced outage hours are the sum of hours of reduced production caused by unplanned outages, weighted according to how much capacity was out.

Forced outage is given in percent, while planned outage (for example due to renovations) is given in days per year.

Technical lifetime

The technical lifetime is the expected time for which the storage facility can be operated within, or acceptably close to, its original performance specifications, provided that normal operation and maintenance takes place. During this lifetime, some performance parameters may degrade gradually but still stay within acceptable limits. For instance, efficiencies often decrease slightly (few percent) over the years, and O&M costs increase due to wear and degradation of components and systems. At the end of the technical lifetime, the frequency of unforeseen operational problems and risk of breakdowns is expected to lead to unacceptably low availability and/or high O&M costs. At this time, the plant is decommissioned or undergoes a lifetime extension, which implies a major renovation of components and systems as required making the storage unit suitable for a new period of operation.

The technical lifetime stated in this catalogue is a theoretical value inherent to each technology, based on experience. The expected technical lifetime takes into account a typical number of start-ups and shut-downs.

In real life, specific storage facilities of similar technology may operate for shorter or longer times. The strategy for operation and maintenance, e.g. the number of operation hours, start-ups, and the reinvestments made over the years, will largely influence the actual lifetime.

The lifetime is expressed in years for all the storage technologies. For electrical batteries it is expressed both in years and in number of cycles, since different utilization of the battery in terms of frequency of charge/discharge depth has an impact on its lifetime. This second figure is specified in the Technology Specific Data.

To calculate the technical lifetime in years for batteries based on the total number of cycles, a certain number of cycles per year has been assumed and is expressed in the notes.

Construction time

Time from final investment decision (FID) until commissioning completed (start of commercial operation), expressed in years.

Regulation ability

The regulation ability parameters are expressed for electricity storage application, while for heat and gas storage these parameters are not relevant.

The electricity regulation capabilities of the technologies are described by two parameters:

- Response time from idle to full-rated discharge (sec)
- Response time from full-rated charge to full-rated discharge (sec)

The response time from idle to full-rated discharge is defined as the time, in seconds, the electricity storage takes to reach 100% of the discharge capacity from idle condition. It is assumed to be equal for the charging process.

The response time from full-rated charge to full-rated discharge is defined as the time, in seconds, the electricity storage takes to go from charging at full capacity to discharging at full capacity. It is assumed to be equal in the other direction.

Financial data

Financial data are all in Euro (€), fixed prices, at the 2015-level and exclude value added taxes (VAT) and other taxes.

Several data originate in Danish references. For those data a fixed exchange ratio of 7.45 DKK per € has been used.

The previous catalogue was in 2011 prices. Some data have been updated by applying the general inflation rate in Denmark (2011 prices have been multiplied by 1.0585 to reach the 2015 price level).

European data, with a particular focus on Danish sources have been emphasized in developing this catalogue. This is done as generalizations of costs of energy technologies have been found to be impossible above the regional or local levels, as per IEA reporting from 2015 [8]. For renewable energy technologies this effect is even stronger as the costs are widely determined by local conditions.

Investment cost

The investment cost is also called the engineering, procurement and construction (EPC) price or the overnight cost. Infrastructure and connection costs, i.e. electricity, fuel and water connections inside the premises of a plant, are also included.

The rent of land is not included but may be assessed based on the space requirements, if specified in the qualitative description.

The owners' predevelopment costs (administration, consultancy, project management, site preparation, approvals by authorities) and interest during construction are not included. The costs to dismantle decommissioned plants are also not included. Decommissioning costs may be offset by the residual value of the assets.

The total investment cost is reported on a normalized basis, i.e. cost per MWh of storage capacity. It is the total investment cost divided by the energy storage capacity for one unit, stated in the table.

For most of the storage technologies it is possible to identify three main cost components: an *energy* component, a *capacity* component and other fixed costs. Where possible, total investment costs is divided into these components.

The cost of energy component includes all the cost related to the equipment to store the energy, which you would incur in case you want to expand the MWh rating of the system, for example battery modules, reservoirs in a pumped-hydro plant or heat tank. The cost of capacity component refers to the part of equipment which condition or convert the energy carrier and make it available to the user or the grid, for example converter and grid connection for a battery system, turbine/pump and grid connection for pumped-hydro plant and heat exchanger and piping for a heat storage. This is the cost you would incur if you would increase the MW capability of the system. Finally, another cost component reflects the fixed costs related to the project, such as data management and control system, project engineering, other civil works, commissioning.

Summarizing, the components considered are the following:

- *Cost of Energy component* (C_E) [M€/MWh]: cost related to the equipment to store the energy (incl. their installation);
- *Cost of Capacity component* (C_P) [M€/MW]: cost related to the equipment to condition or convert the energy carrier and make it available to the user or the grid (incl. their installation);
- *Other project costs* (C_{other}) [M€]: includes fixed costs which do not scale with capacity or energy, such as those for data management and control system, project engineering, civil works, buildings, site preparation, commissioning.

In this catalogue, the **Total investment cost** is expressed in relative terms, in M€/MWh, by dividing the Total Capital Expenditure by the *Energy storage capacity for one unit* in MWh.

$$\text{Total Capital Expenditure} = C_E * E_{SC} + C_P * P_{out} + C_{other} \quad [M\text{€}]$$

$$\text{Total investment cost} = \frac{\text{Total Capital Expenditure}}{E_{SC}} = C_E + \frac{C_P}{h} + \frac{C_{other}}{E_{sc}} \quad [M\text{€}/MWh]$$

where:

E_{SC} = Energy Storage Capacity for one unit [MWh]

P_{out} = Output capacity for one unit [MW]

$h = \frac{E_{sc}}{P_{out}}$ = unload hours [h]

For electricity storage applications with a power-intensive service, an alternative Total investment cost in M€/MW is indicated in the Technology specific data, calculated by dividing the Total Capital Expenditure by the *Output capacity for one unit* ($\text{Total Capital Expenditure} / P_{out}$).

Cost of grid expansion

The costs for the connection of the storage unit to the system are included in the investment cost (shallow costs), while no cost of grid expansion or reinforcement is taken into account in the presented data (deep costs).

Business cycles

The cost of energy equipment shows fluctuations that can be related to business cycles. This was the case of the period 2007-2008 for example, where costs of many energy generation technologies surged dramatically. The trend was general and global. An example is combined cycle gas turbines (CCGT), where prices increased sharply from \$400-600 per kW to peaks of \$1250. When projecting the costs of technologies, it is attempted, as far as possible, to compensate for the effect of any business cycles, that may influence the current prices.

Economy of scale

A typical size of the storage unit is stated in the technology description and data-sheet. No economy of scale or scaling rule is considered in this catalogue. Instead, the cost components for energy and capacity are specified for the technologies. It is intended to be used in a limited range around the typical capacity and not, for example, for doubling the capacity.

In case a technology has a modular nature and could be scaled across different sizes, this will be specified in the specific technology chapter.

Operation and maintenance (O&M) costs

The fixed share of O&M can be expressed in two different ways.

1. The fixed share of O&M can be expressed in terms of percentage (%) of the Total investment cost, as defined in the previous paragraph and stated in the tables
2. The fixed share of O&M is calculated as cost per energy storage capacity for one unit per year (€/MWh/year), where the energy storage capacity is the one defined at the beginning of this chapter and stated in the tables

It includes all costs which are independent of how the storage system is operated, e.g. administration, operational staff, payments for O&M service agreements, network or system charges, property tax, and insurance. Any necessary reinvestments to keep the unit operating within the technical lifetime are also included, whereas reinvestments to extend the life are excluded. Reinvestments are discounted at 4 % annual discount rate in real terms. The cost of reinvestments to extend the lifetime of the storage unit may be mentioned in a note if the data are available.

The variable O&M costs (€/MWh) are calculated as costs per MWh of energy effectively released by the storage. They include consumption of auxiliary materials (water, lubricants, fuel additives), treatment and disposal of residuals, output related repair and maintenance, and spare parts (however not costs covered by guarantees and insurances).

Auxiliary electricity consumption is included for heat and gas storage technologies. The electricity price applied is specified in the notes for each technology, together with the share of O&M costs due to electricity consumption. This enables corrections from the users with own electricity price figures. The electricity price does not include taxes and PSO.

For electricity storage technologies, auxiliary electricity consumption is included in the round-trip efficiency instead.

Planned and unplanned maintenance costs may fall under fixed costs (e.g. scheduled yearly maintenance works) or variable costs (e.g. works depending on actual operating time), and are split accordingly.

It should be noticed that O&M costs often develop over time. The stated O&M costs are therefore average costs during the entire lifetime.

Technology specific data

Additional data is specified in this section, depending on the form of energy stored.

In heat and gas storage systems the volume (m³) and pressure (bar) is specified. For heat applications, the storage temperature sets are indicated as well (°C).

For heat storage units, energy density (Wh/m³) at relevant temperatures is expressed, for example 80/40°C, 60/35°C and 20/5°C (ATES).

Energy density for gas storage systems is indicated in Wh/Nm³.

For electricity storage technologies (batteries in particular) the power density (W/m^3) and energy density (Wh/m^3) are stated, as well as the specific energy (Wh/kg) and specific power (W/kg).

For power intensive-applications, the total investment cost per MW is also stated, as an alternative figure to the total investment in €/MWh (see Financial data paragraph above for clarification).

Moreover, for technologies where it is relevant, such as pumped hydro and cavern gas storage, the leakage of methane is shown in m^3 per year.

The following table summarizes the technology specific data for each of the categories:

Technology specific data		
Electricity	Heat	Gas
Alternative Total investment cost (M€/MW) for power-intensive applications	-	-
-	Volume (m^3)	Volume (m^3)
-	Pressure (bar)	Pressure (bar)
	Temperature sets ($^{\circ}C$)	
Lifetime in total number of cycles		
Specific power (W/kg)	-	-
Power density (W/m^3)	-	-
Specific energy (Wh/kg)	-	-
Energy density (Wh/m^3)	Energy density (Wh/m^3)	Energy density (Wh/Nm^3)
Water leakage ($m^3/year$) for pumped hydro	-	Methane leakage ($m^3/year$) for gas storage in cavern.

Definitions

Based on the service provided, electricity storage technologies can be divided into two main categories: power-intensive and energy-intensive.

Power-intensive applications are required to provide ancillary services to the electricity system in maintaining the balance of frequency and voltage or providing power quality. Power intensive applications do this by delivering large amounts of power for time periods on the scale of seconds or minutes, and thus, they are characterized by a high ratio of power to energy (short discharge times) and fast response.

Energy-intensive applications are used for storing large amounts of energy in order to match demand and supply, perform load leveling or reducing congestion in the network. These technologies are characterized by a lower ratio of power to energy (long discharge times) and used on an hourly to seasonal scale.

The distinction between technologies providing power or energy intensive services is not always clear and neat. Some technologies, such as pumped-hydro or Li-ion batteries, can provide both services.

References

- [1] Danish Energy Agency: "Forudsætninger for samfundsøkonomiske analyser på energiområdet" (Generic data to be used for socio-economic analyses in the energy sector), May 2009.
- [2] "Technology Data for Hydrogen Technologies", EUDP Project, 2015.
- [3] "Strategy for Storage and Distribution of Energy", The Danish Partnership for Hydrogen and Fuel Cells, June 2015.
- [4] "Thermal Energy Storage. Technology Brief", IEA-ETSAP and IRENA, January 2013.
- [5] "Electricity Storage. Technology Brief", IEA-ETSAP and IRENA, April 2012.
- [6] "Energy Technology Perspectives", International Energy Agency, 2012.
- [7] International Energy Agency. Available at: <http://www.iea.org/>. Accessed: 11/03/2016.
- [8] "Projected Costs of Generating Electricity", International Energy Agency, 2015.
- [9] "Konvergensprogram Danmark 2015". Social- og Indenrigsministeriet. March 2015.

ELECTRICITY STORAGE

Electricity storage is a key technology to enable the next phase of the energy transition, driven by the large-scale deployment of variable renewable energy sources (VRES) like solar and wind power. The technologies presented in this chapter will help to cope with the integration challenges arising from intermittent generation sources: the needs to both ensure the balance of production and consumption in real time maintaining the quality of supply and to store excess electricity over different time horizons (minutes, days, weeks).

In 2017, it is estimated that 4.67 TWh of electricity storage exists, 96% of which in form of pumped-hydro storage. The total amount of electricity storage worldwide is set to triple from 2017 to 2030, with a foreseeable reduction of the share of pumped-hydro, in favor of battery energy storage (BES) systems, which capacity is set to increase 17-fold driven by growth of utility scale and local behind-the-meter applications [1].

While electrical energy storage systems are identified by the fact that they can be utilized to exchange power (the energy carrier) with the grid, different types of them can be identified, depending on the energy form ultimately stored. They are illustrated in Figure 1:

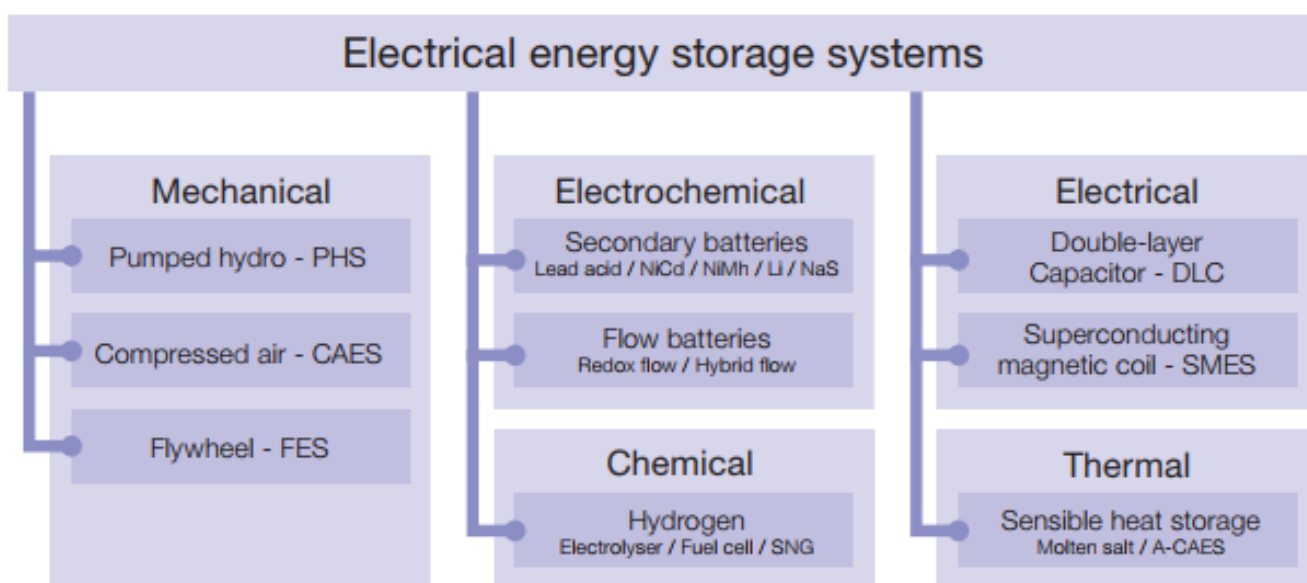

Figure 1 Classification of electrical energy storage systems according to energy form. Source [2]

Electricity storage characteristics and services

The services electricity storage can provide are various and are inherently related to the physical characteristics of the storage media and the storage system. One way to categorize the different storage systems and the potential service they can provide is by looking at their power rating and the discharge time at rated power. Figure 2 shows how different types of storage classify with respect to these two variables.

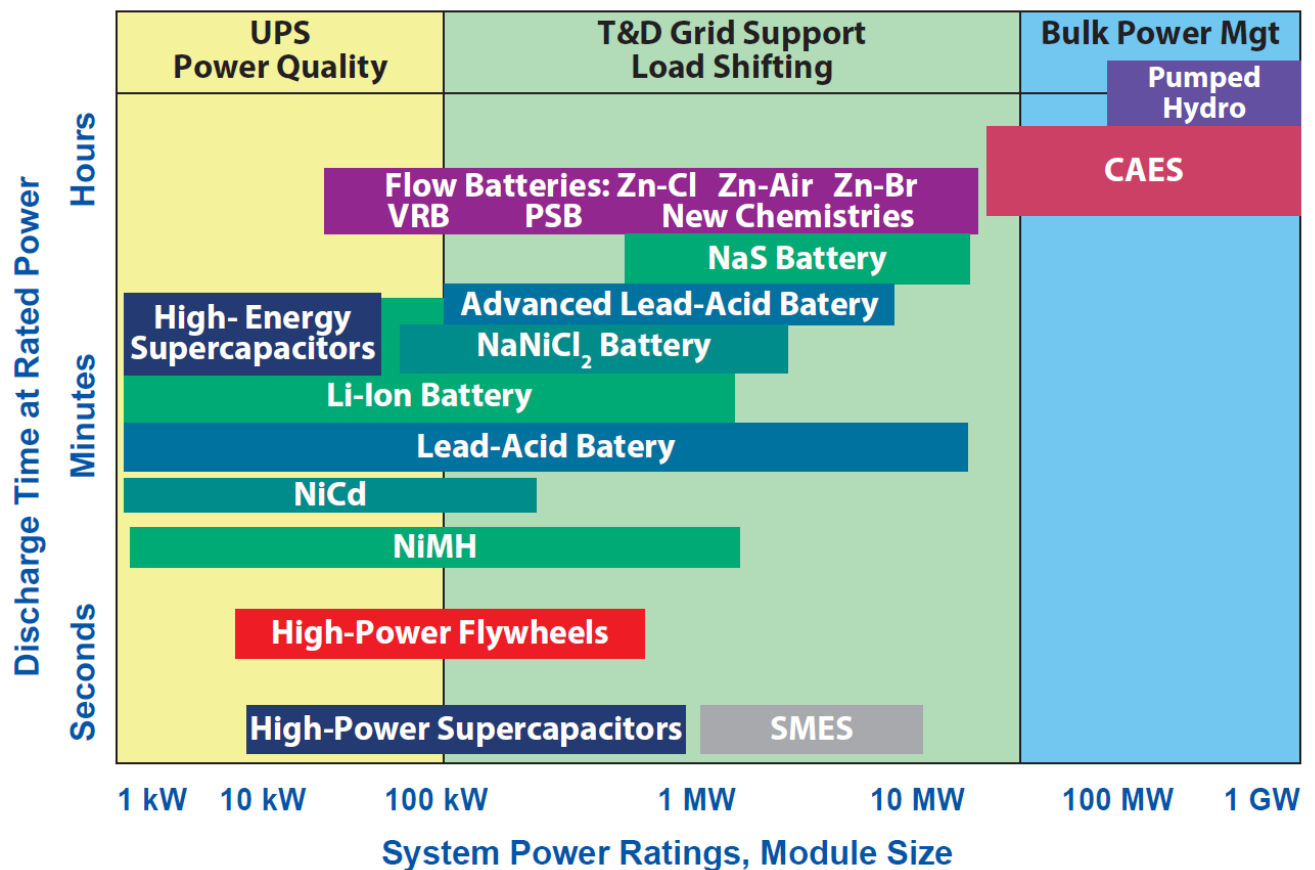

Figure 2. System power rating versus discharge time at rated power for different storage technologies [1].

Based on their characteristics and positioning in Figure, electricity storage technologies can be divided into two main categories: power-intensive and energy-intensive.

Power-intensive applications are required to provide ancillary services to the system in maintaining the balance of frequency and voltage or providing power quality. Power intensive applications do this by delivering large amounts of power for time periods on the scale of seconds or minutes, and thus, they are characterized by a high ratio of power to energy (short discharge times) and fast response.

Energy-intensive applications are used for storing large amounts of energy in order to match demand and supply, perform load leveling or reducing congestion in the network. These technologies are characterized by a lower ratio of power to energy (long discharge times) and used on an hourly to seasonal scale.

The potential applications for electricity storage across the entire value chain are various. Some of these applications refers to more energy-intensive services, while others to power-intensive ones. The most important ones can be categorized as follows¹:

- **Time-shift:** purchase of electricity when the price is lower to use it or sell it when the price is higher (also referred to as *arbitrage*). The effect is an increased demand in hours with lower load (*load levelling*), with advantages related to the generation pattern of conventional plants, and a reduction of the peak demand (*peak shaving*), resulting in a lower utilization of more expensive generators and a lower strain on the system. This service includes the potential provision of peak power to ensure system adequacy, when the power system is under stress².
- **Time-of-use management and self-consumption:** residential and small commercial application to maximize the self-consumption of solar photovoltaics or to shift the consumption in hours with lower tariffs. The application principle is similar to time-shift, but more small-scale/local.
- **RE capacity firming and production smoothing:** compensation of the fluctuations of the production from variable renewables (e.g. solar and wind) to obtain a more predictable and regular generation profile. Reduction of the balancing cost for the plant operator and, from a system perspective, reduced need for reserve and modulation/ramping of conventional plants.
- **Network support and investment deferral:** postponement of costly expansion of the power network thanks to the reduction of situations of overload and congestions in transmission or distribution networks. In connection to variable renewables, it refers also to the reduction of curtailed energy.
- **Primary regulation:** participation in the primary frequency regulation, ensuring the balance between production and consumption is restored in the event of frequency deviations. The response time for the primary regulation is 15-30 sec. It is also referred to as Frequency Containment Reserve (FCR).
- **Secondary regulation:** participation in the secondary frequency regulation, ensuring the frequency is brought back to its nominal value after a major system disturbance. The response time of secondary regulation is 15 min. It is also referred to as Automatic Frequency Restoration Reserve (aFRR).
- **Tertiary regulation:** participation in the tertiary frequency regulation, which partially complements and replaces secondary reserve by re-scheduling generation. The response time must be within 15 minutes. It is also referred to as Manual Frequency Restoration Reserve (mFRR).

¹ The list of descriptions and applications are based on elaborations from [1], [11] and [12].

² Provision of peak power is very similar to arbitrage in terms of requirements from the storage system, but it differs in the utilization rate. The service of peak power provision would be activated only during very few hours in the year, where the price is very high, to ensure adequacy and security of supply. This would be feasible only in the case storage, due to the lower battery costs, becomes competitive with gas or other peaker technologies in terms of capital cost expenditure.

- **Black-start:** service of reestablishment of the grid after a generalized black-out. It can be provided by plants that are able to start operation autonomously, i.e. without alimentation from the grid.
- **Voltage support:** provision of reserve for the modulation of reactive power in specific nodes of the grid for voltage management purposes.
- **Power quality:** refers to a number of services related to the improvement of the quality of the power supplied. For example, improved voltage quality (compensation of voltage dips and distortion of voltage), reduction of the impact of distorting loads (e.g. harmonics, flicker) and shaving of localized power peaks (timescale of seconds).

The suitability of different storage technologies for the specific applications described are shown in Table 1³.

Application	Hydro	CAES	NaS	NaNiCl	Li-Ion	Redox	Fly-wheel
<i>Time-shift</i>	●	●	●	●	●	●	●
<i>Time-of-use management</i>	●	●	●	●	●	●	●
<i>RE firming and smoothing</i>	●	●	●	●	●	●	●
<i>Network support and deferral</i>	●	●	●	●	●	●	●
<i>Primary regulation</i>	●	●	●	●	●	●	●
<i>Secondary regulation</i>	●	●	●	●	●	●	●
<i>Tertiary regulation</i>	●	●	●	●	●	●	●
<i>Black start</i>	●	●	●	●	●	●	●
<i>Voltage support</i>	●	●	●	●	●	●	●
<i>Power quality</i>	●	●	●	●	●	●	●

Legend: ● Suitable ● Less suitable ● Not suitable

Table 1 Suitability of different electricity storage technologies for different applications. Adapted from [3].

Based on data from the U.S. DOE Database of Storage project [4], today the main uses of electricity storage by technology group are those displayed in Figure. The vast majority of pumped-hydro storage is used for Time-shift applications, followed by capacity firming and black start capabilities. Differently, electro-chemical storage is used for frequency regulation and provision of reserve, with

³ The suitability for the different services is primarily based on [1], [3] and [11]. Additional and more recent information have been considered. For example, thanks to the current reduction in cost, Li-ion batteries are starting to be deployed for energy-intensive services such as time-shift and load management. See for example: [13], [14] and other Li-ion projects with more than 4h of storage duration in [4].

a lower share dedicated to more energy-intensive services like time-of-use management and time shift. Electro-mechanical storages, like flywheel systems, see the largest deployment in on-site power quality services and black start.

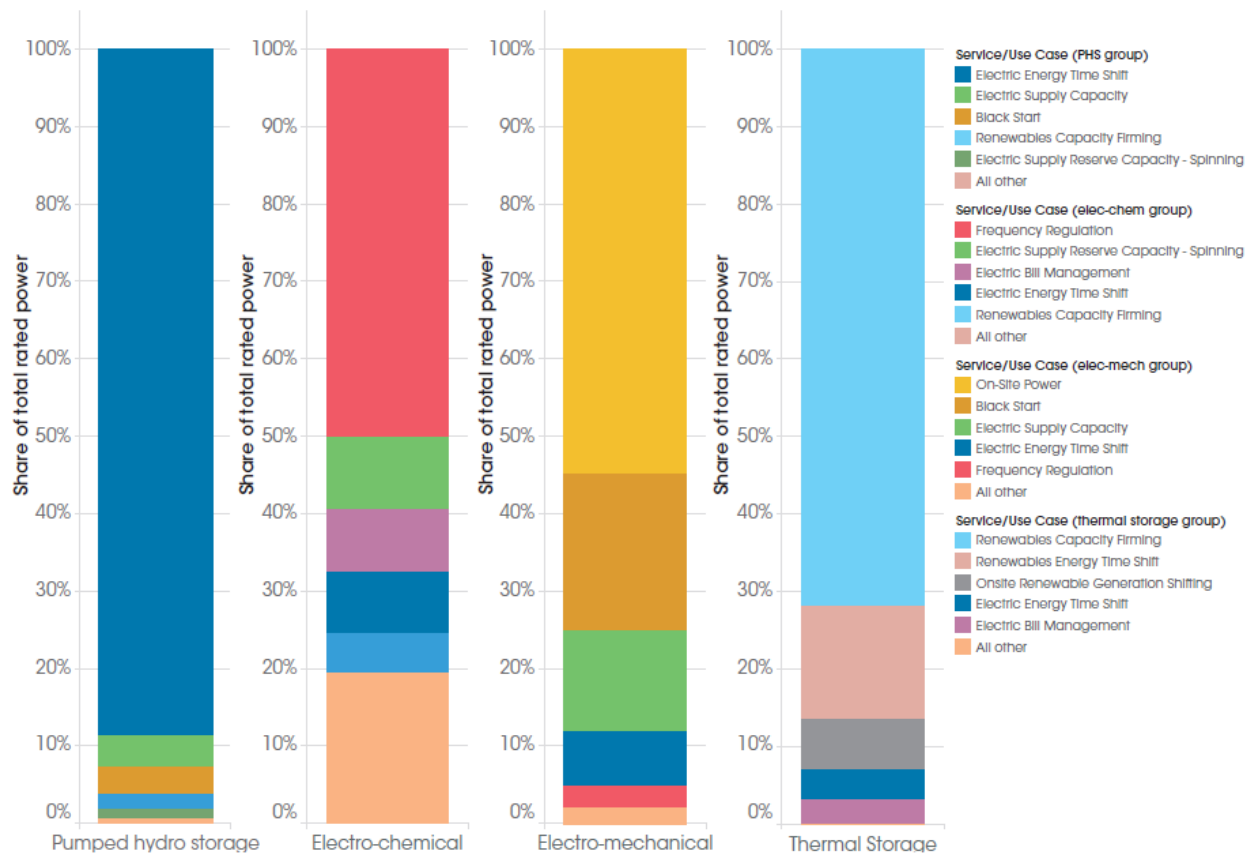

Figure 3 Global Energy Storage power capacity share by main use and technology group. Source [1].

In the future, electro-chemical storage is expected to experience an evolution towards more energy-intensive applications, following the reduction of battery cost. IRENA [1] estimates that its main applications will be:

- Energy shifting for PV to increase self-consumption (60-64%)
- RE capacity firming and smoothing at utility scale (11-14%)
- Frequency regulation (10-15%)
- Ability to provide multiple services and “stack” revenues

Components of electricity storage cost

The system considered when defining the characteristics of the electrical energy storage - in particular its cost and efficiency performance - is the entire energy storage system including the connection to the grid. The system boundaries and the subdivision of the equipment in the three cost components, as defined in the *Investment cost* paragraph of the main guideline, are shown below for different electricity storage technologies.

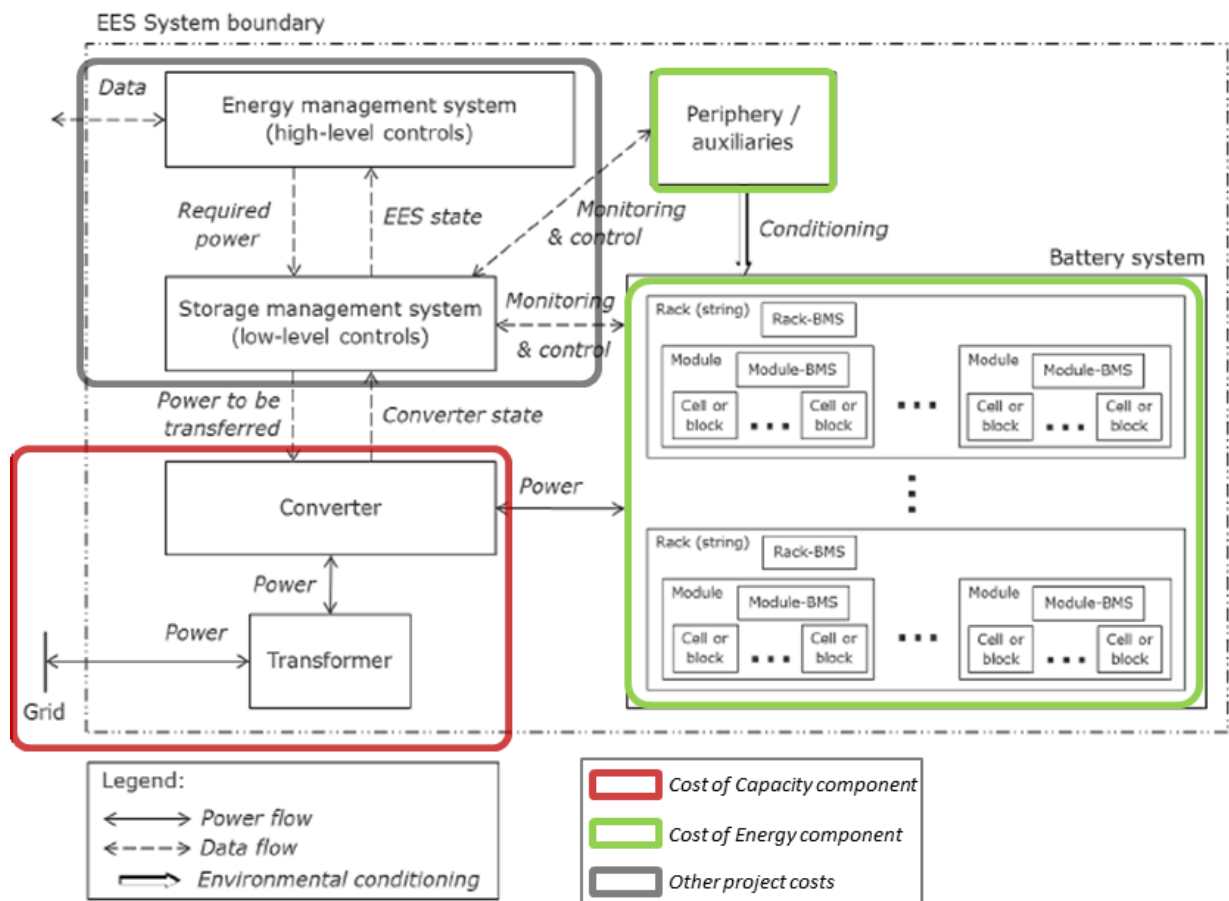

Figure 4 Components and their categorization for cell-based batteries, such as Li-ion, NaS and NaNiCl. Source: elaboration of [5].

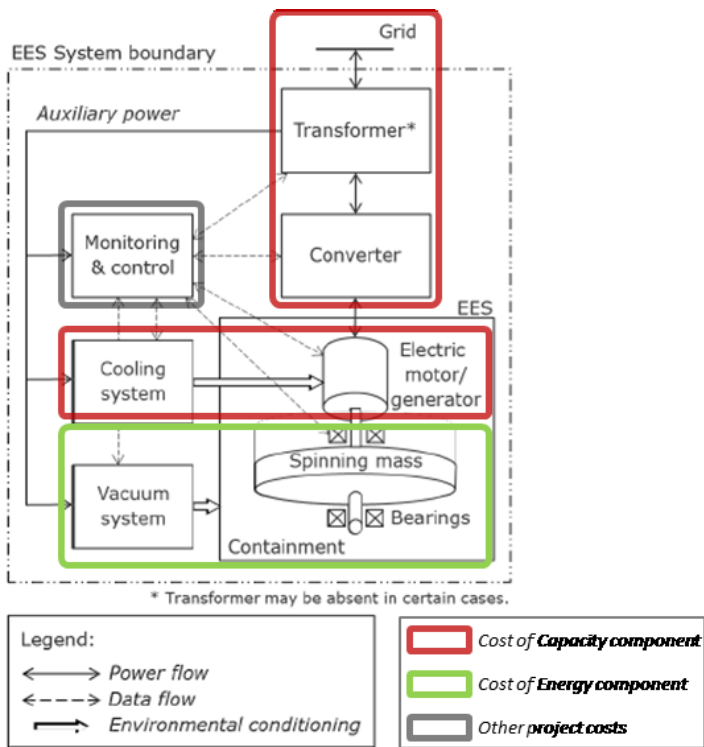

Figure 5 Components and their categorization for Flywheel. Source: elaboration of [5].

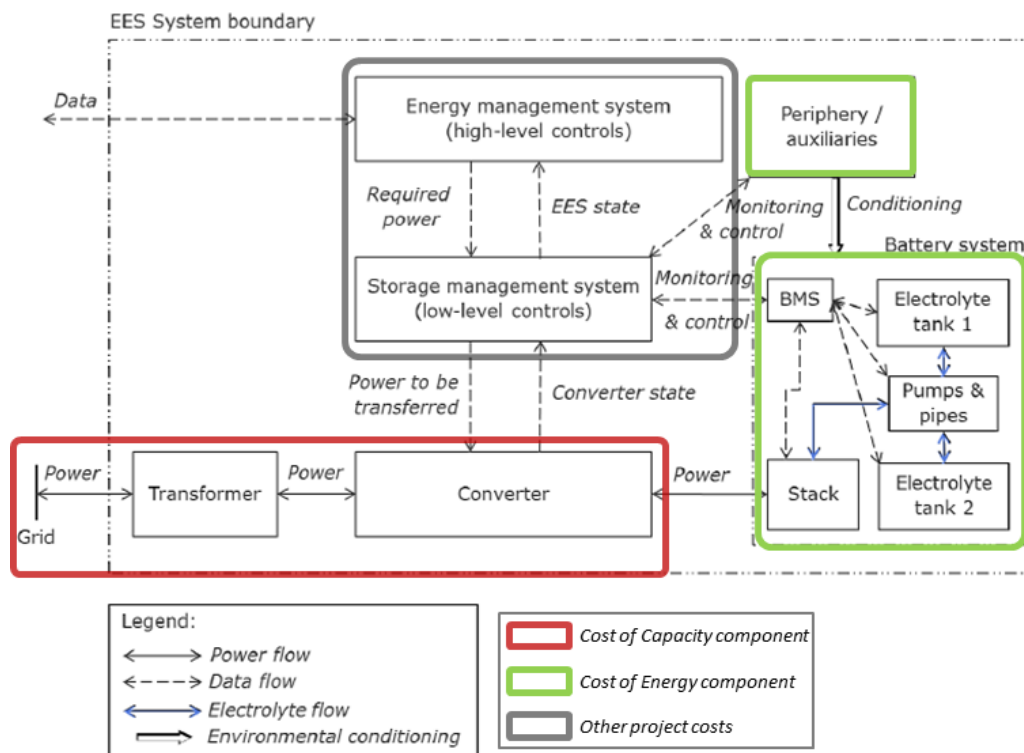

Figure 6 Components and their categorization for Vanadium-redox flow battery. Source: elaboration of [5].

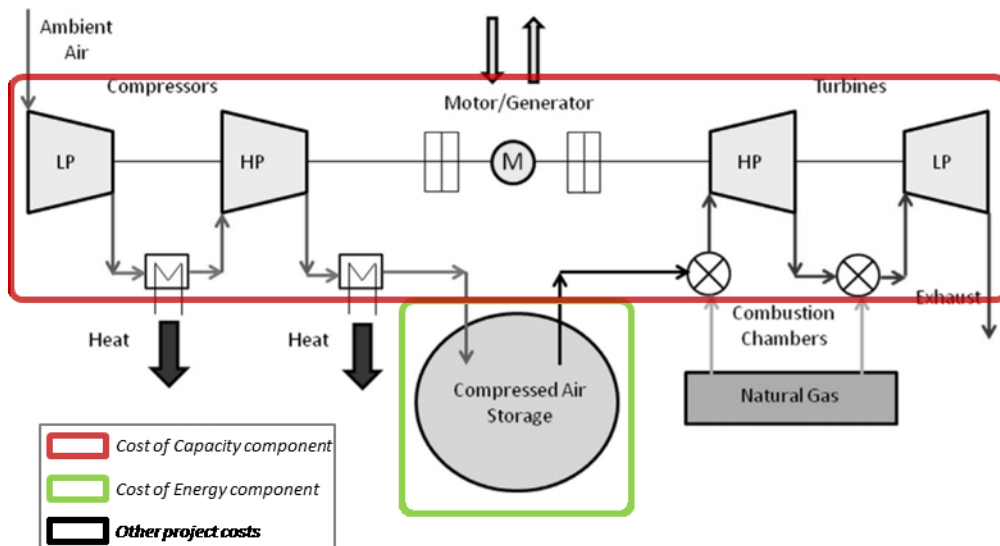

Figure 7 Components and their categorization for CAES. Source: elaboration of [5].

Energy component

The energy component includes the following equipment and its installation:

- Cell-based batteries: battery modules, battery management system (BMS), local protection, racking frame/cabinet;
- Vanadium-redox: electrolytes, pumps and pipes, stack, battery management system (BMS);
- Flywheel: spinning mass, bearings, containment and vacuum system;
- Compressed Air Energy Storage: pressure tank or underground cavern, cavity or aquifer. Includes the air shaft.

For batteries and vanadium redox storage, auxiliaries for cooling are considered in the energy component, since they need to be scaled when more cells or electrolytes are added to increase the energy storage capacity.

Capacity component

The capacity component includes the following equipment and its installation:

- Cell-based batteries and vanadium-redox: power conversion system (PCS), grid connection and protection;
- Flywheel: power conversion system (PCS), grid connection and protection, as well as electric motor/generator and cooling system;
- Compressed Air Energy Storage: all the components excluding tank/cavern (energy component) and those that falls under *other costs*. Includes the grid connection.

Grid connection

The costs for the connection of the storage unit to the power system are included (shallow costs), while no cost of grid expansion or reinforcement (deep costs) is taken into account.

For system level application, unless otherwise stated, the connection is assumed to be at medium level voltage. The costs include: step-up transformer (low-medium voltage for BES), switchgears, breakers, meters and dedicated cabling to reach the connection point. In case of local level applications of BES, the transformer is not needed and the battery is normally connected to the low voltage, with a low cost for grid connection.

Power conversion system (PCS)

The power conversion system (or power conditioning system) ensures the bi-directional conversion AC to DC and DC to AC during charge and discharge respectively. This is done through a bi-directional inverter. To control the voltage level and avoid harmonics in the grid, a two-stage converter is sometimes used, complementing the inverter with a DC-DC converter to keep the inverter DC voltage constant [6].

An important design parameter is the voltage range in which the converter works. Today's applications are typically at 1000V, but some 1500V applications are emerging [7].

The cost of power conversion for battery storage systems, based on a number of references [8] [9] [10], is the range 0.2-0.3 M€/MW (0.4-0.5 M€/MW if including the connection to the grid). This is higher than the inverter cost for photovoltaic (PV) plants.

Among the reasons for a higher cost is the necessity for higher power performance and compliance to grid codes to provide ancillary services, bidirectional electricity flow and two-stage conversion, as well as the early stage of development and the fact that few manufacturers can guarantee turnkey systems [7].

In the future, with larger deployment of the technology and a move towards more commercial phase, the price of power conversion system (PCS) can be expected to drop, which is also the case for the module cost.

References

The following list includes the references used in Chapter 2.

- [1] IRENA, "Electricity storage and renewables: Costs and markets to 2030," 2017.
- [2] International Electrotechnical Commission (IEC), "Electrical Energy Storage - White Paper," 2011.
- [3] A. Schrøder Pedersen, "European Energy Storage Technology Development Roadmap towards 2030," 2014.
- [4] U.S. Department of Energy, "Global Energy Storage Database." [Online]. Available: <https://www.energystorageexchange.org/>. [Last viewed 01.12.17].
- [5] DNV GL, "Safety, operation and performance of grid-connected energy storage systems," 2017.
- [6] M. Andriollo, R. Benato, M. Bressan, S. D. Sessa, F. Palone, and R. M. Polito, "Review of power conversion and conditioning systems for stationary electrochemical storage," *Energies*, vol. 8, no. 2, pp. 960–975, 2015.
- [7] "Interview with the manufacturer NIDEC." 2018.
- [8] R. Benato, G. Bruno, F. Palone, R. M. Polito, and M. Rebolini, "Large-scale electrochemical energy storage in high voltage grids: Overview of the Italian experience," *Energies*, vol. 10, no. 1, 2017.
- [9] B. Zakeri and S. Syri, "Electrical energy storage systems: A comparative life cycle cost analysis," *Renew. Sustain. Energy Rev.*, vol. 42, pp. 569–596, 2015.
- [10] G. Huff *et al.*, "DOE/EPRI 2013 electricity storage handbook in collaboration with NRECA," 2013.
- [11] Ricerca sul Sistema Energetico - RSE, "RSEview: L'accumulo di energia elettrica," 2011.
- [12] Energinet.dk, "Ancillary Services To Be Delivered in Denmark," 2017.
- [13] Enel, "Enel signs 85 mw of capacity storage agreements in us with pacific gas and electric," 2017. [Online]. Available: <https://www.enel.com/media/press/d/2017/12/enel-signs-85-mw-of-capacity-storage-agreements-in-us-with-pacific-gas-and-electric>. [Last viewed 01.02.18].
- [14] Lyon Energy, "LYON's Energy Storage Projects," 2017. [Online]. Available: <http://lyonbatterystorage.com.au/>. [Last viewed 01.02.18].

140 SEASONAL HEAT STORAGE

Contact information

Danish Energy Agency: Filip Gamborg, fgb@ens.dk

Energinet.dk: Rune Duban Grandal, rdg@energinet.dk

Author: Max Guddat, PlanEnergi

Publication date

November 2018

Amendments after publication date

Date	Ref.	Description

Brief technology description

Seasonal heat storage (for district heating purposes) is normally based on water as storage medium, but other storage mediums can be used as well.

Seasonal heat storages are generally defined as storages with a storage cycle longer than one week up to one year.

This technology sheet addresses different options for long-term (seasonal) heat storage for district heating systems:

- PTES, pit thermal energy storage (focal technology in the chapter)
- BTES, borehole thermal energy storage, ground storage with closed loops
- ATES, aquifer thermal energy storage, ground storage with open loops
- TTES, tank thermal energy storage

For PTES and TTES, treated water (district heating water) is the storage medium in order to avoid corrosion. For ATES and BTES, the surrounding soil or aquifer is the storage medium.

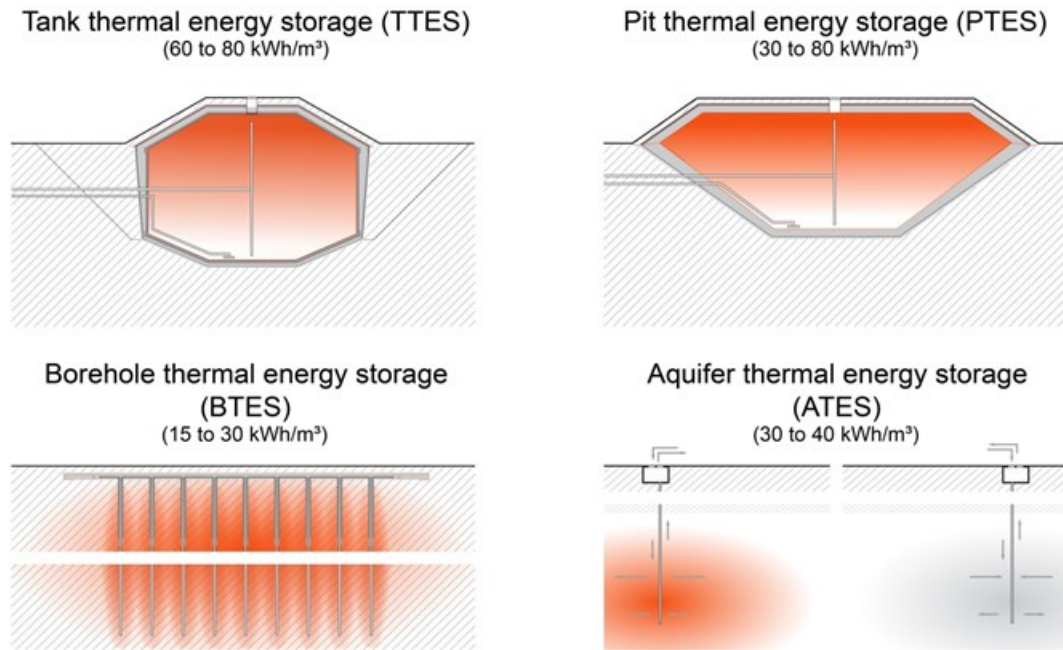

Figure 1: Seasonal thermal energy storage – concepts. Specific storage capacity given at typical operation temperatures of the given storage concepts [13].

A hot-water tank (TTES) is like the water tanks used for short-term (diurnal) heat storage, only bigger. They are used as seasonal storage for solar heating systems in e.g. Germany, where the biggest tank is 12,000 m³ [2]. The TTES is not further addressed in this chapter, see chapter 141 “Large-scale hot water tanks”. The technologies PTES, ATES and BTES will be outlined in the following.

Pit thermal energy storages (PTES)

In principle, a pit heat storage (PTES) is a large water reservoir for storing of thermal energy. The use of water as a storage medium has several advantages; it is non-toxic, enables stratification (layering according to different temperature levels), high capacity when charging and discharging, good heat transfer characteristics and high specific heat capacity. Moreover, water is comparably cheap.

PTES using plastic liners is a relatively cheap storage technology, developed for operation with solar thermal. The application is emerging in Denmark. PTES following the Danish concept could be developed for operation at relatively high temperature levels (90°C all year round) increasing the area of application to excess heat from industries and waste incineration and as buffer storage for power plants.



Figure 2: Principle sketch of a pit heat storage cross section [15].

The pit heat storage can be designed with different shapes but the simplest is an excavation shaped as a truncated pyramid placed upside down in the ground as shown in Figure 2. To minimize the cost of soil handling and transportation the excavation is made with soil balance which means that the soil excavated from the bottom part of the storage is used as embankments around the upper part of the storage. The necessary volume of the storage depends on the overall system it is connected to and it is necessary to make a calculation model of the overall system to find the optimal volume.

PTES is the most commonly used seasonal storage technology in Denmark, since initial demonstrations showed that this is the most cost-effective solution for large volumes [1, 4]. A water pit in the Danish version is essentially a hole in the ground lined by a water-proof membrane, filled with water and covered by a floating and insulating lid. The excavated soil may be used as banks surrounding the hole, thus increasing the water depth and reducing establishing costs, as local resources may be utilized.

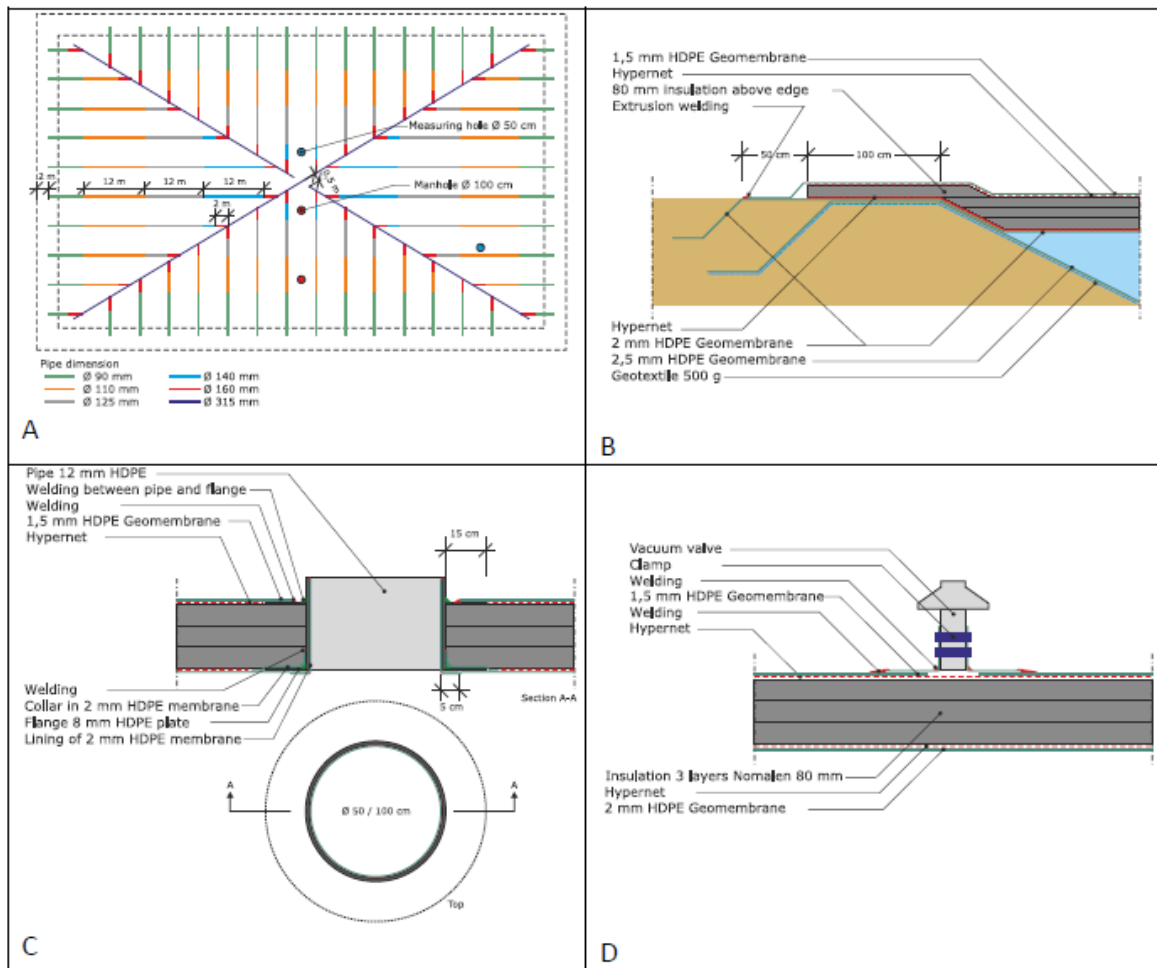

Figure 3: Illustrations of the lid in SUNSTORE 4 Marstal. A: the lid from above showing the pipes, B: the edge of the PTES, C: manhole, D: vacuum valve [1].

The heat loss depends on several parameters such as geometry, storage temperatures, operation pattern, cycle duration and weather conditions.

A characteristic figure for the heat loss per amount of stored energy is the surface/volume ratio of the store. A small store with a volume of e.g. 20 m³ has a surface to volume ratio that is eight times the ratio of a store with 10,000 m³. Hence, the heat losses referred to the stored energy are eight times higher for the small store than for the large one.

Another important issue is, whether a heat pump is used to cool the stored water. Doing so decreases the annual heat losses substantially. The heat losses from a pit store are larger during the first two years than afterwards, as the surrounding soil will be heated.

The heat loss from the PTES in Marstal (SUNSTORE 4) has been **calculated** to be 0.28 MW after 20 months of operation corresponding to a decrease in temperature of 0.08 K/day (average temperature 78 °C). After these 20 months of initial charging, the storage is (in the energy model) “closed” in order to evaluate the heat losses, i.e. the only energy flow in the following period is the heat loss off the storage. 12 months later, the decrease in temperature is calculated to be 0.04 K/day (average temperature 56°C) [1].

PTES are characterized by a significant effect of economy of scale as illustrated in Figure 4.

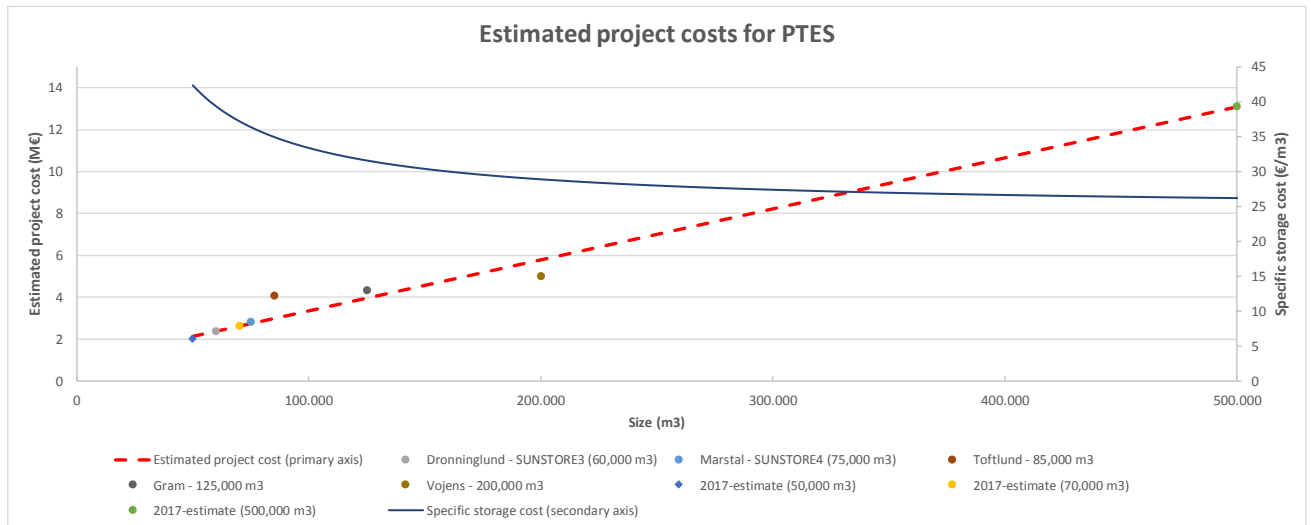

Figure 4: Project costs for PTES in Denmark [5, 16].

Borehole Thermal Energy Storages (BTES)

BTES, a system consisting of tubes in boreholes (duct storage) operated in combination with heat pumps, is implemented in several countries. A typical BTES operates at low temperatures (0 to 30°C). The storage efficiency can reach 90 to 100 % when the BTES is operating around the average natural temperature of the ground [3], and there is no strong natural groundwater flow. Furthermore, BTES are characterized by requiring a relatively small area of land, as the surface area may be used for other purposes, depending on plant design. BTES can also be used for storing higher temperatures (up to 90°C). A pilot storage (19,000 m³ soil) of that type has been implemented in connection to Brædstrup Fjernvarme in Denmark. Larger storages has a.o. been implemented in Okotoks, Canada and Crailsheim, Germany.

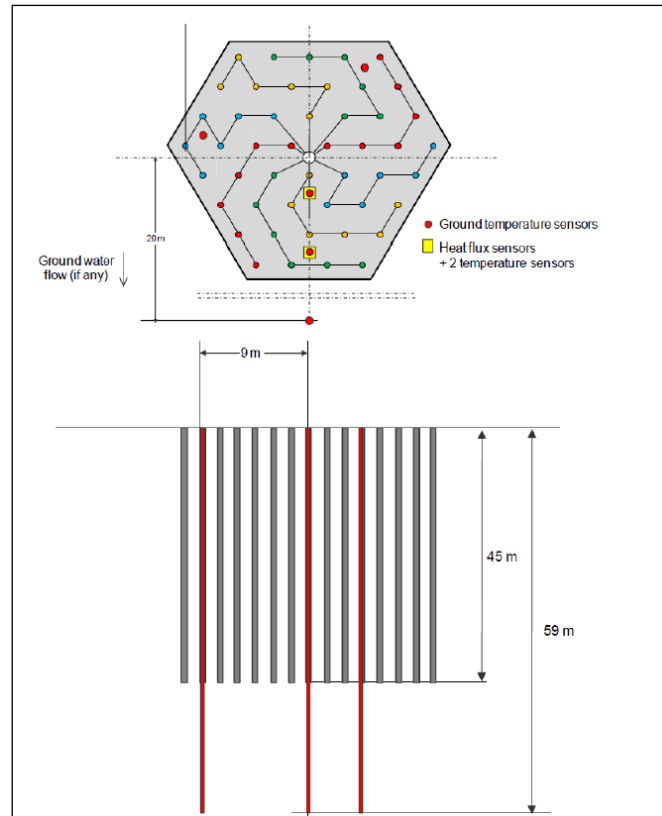

Figure 5: BTES in Brædstrup, Denmark. The depth of the pipes (grey lines) is 45 m, the depth of the ground temperature sensors (red lines) is 59 m. The horizontal distance between sensors is 9 m [1].

The heat loss of an 185,000 m³ BTES has been calculated (simulation), cf. the storage design illustrated above at full-scale deployment. The calculation results in a storage efficiency of 81.5 % [1].

Aquifer Thermal Energy Storage (ATES)

When storing hot and/or cold water in natural underground aquifers, direct heat exchange is taking place through vertical wells, typically one centre well and a number of peripheral wells. Several aquifer stores are being operated together with heat pumps e.g. in the Netherlands and Sweden, for space cooling during summer and heating during winter. China has a long tradition of cold water storage in aquifers. The chemical composition of the aquifer and natural groundwater flow may negatively influence the performance. However, the flow can be managed by extra wells outside the storage area. Aquifer storage is the most cost-effective technique for large low-temperature volumes, when it can be mastered [3].

Charging of the storage is done by pumping ground water through a heat exchanger and then to another location (aquifer) in the ground. The heat is thus stored in the ground. When discharging the storage, the hot water is pumped back up, through the heat exchanger and a heat pump, reducing the temperature of the water. It is then pumped into the first drilling, storing the cold water.

In Denmark, the maximum average temperature is 20°C (by law) and a peak temperature of 25°C. Hence, ATES is low temperature heat storage technology.

Typical ATES capacity (each pair; hot and cold drilling) is 50-60 m³/h, corresponding to 600-700 kW at a temperature difference of 10°C.

The application in Denmark is limited and ATES is mainly applicable for small-scale plants (large office complexes, small district-heating plants etc.) and when both heating and cooling can be utilized. There is currently one ATES-plant in relation to local district heating in Bjerringbro [1].

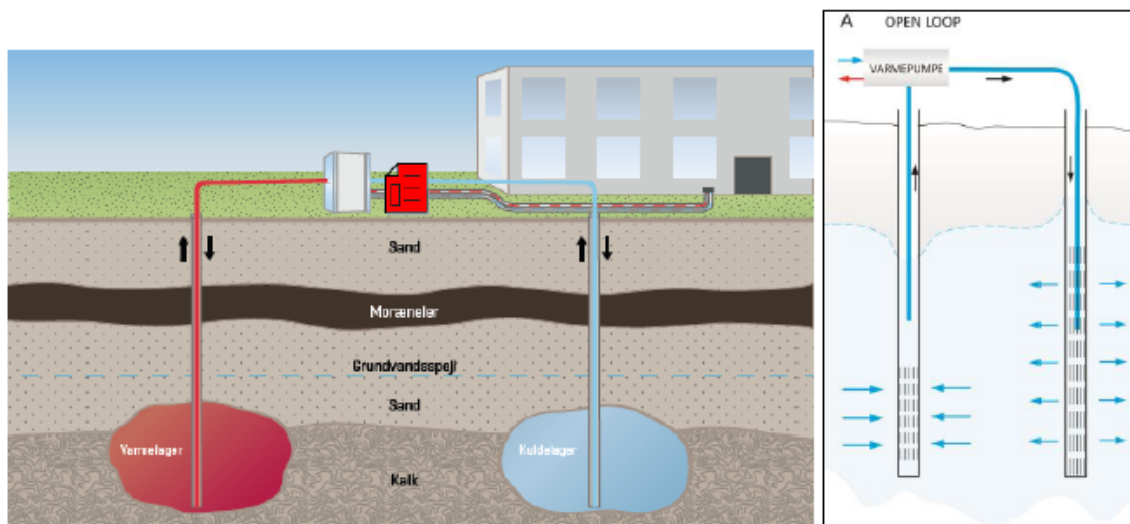

Figure 6: Principle of an ATES [1].

In the remainder of the chapter the descriptions will only refer to the PTES technology, unless otherwise stated.

Input

Hot water from any heat source, e.g. solar collectors or excess heat.

If the heat storage is operated in combination with a heat pump, the input to the heat pump is either electricity or, in the case of an adsorption/absorption heat pump, high temperature heat.

Output

High temperature water for direct district heating or low-mid temperature water for heat pumps or direct low-temperature district heating.

If the heat storage is operated in combination with a heat pump, (district) cooling can be a co-product of the thermal storage.

Typical Capacities (PTES)

Typical capacities for seasonal heat storages are in the range of 50,000-500,000 m³ or 5,000-40,000 MWh at one full charging cycle. Appropriate capacities depend on the total system design, e.g. a desired solar fraction in the context of the capacity of solar thermal collectors and size of the connected heat sink, as well as possible location specific restrictions regarding the maximum size and shape of a heat storage.

For smaller storages (up to approx. 10,000 m³) typically an insulated steel tank (TTES) is used.

Typical Storage Period

A typical application for e.g. solar thermal systems is storage for several months from the summer months to autumn. Using a heat pump to cool the storage further down can expand this period to approx. December. An increase in storage period is typically not economically feasible, unless it can be used to store seasonally available and cheap (excess) heat. The optimal storage period and (i.e. storage capacity) is thus to be determined by the local context, incl. the existing and available heat sources.

Regulation ability and other system services

N.A.

Advantages/disadvantages

Advantages:

The district heating/electricity systems offer a buffer capacity enabling increased utilization of renewable energy sources such as solar thermal and wind turbines (when using P2H-technology to provide the heat) is a generic advantage of seasonal heat storage technologies. The increased buffer also allows cheap baseload units to operate at high capacity during longer periods independent of the seasonal changes in heat demand. This raises the utilization of those units and decreases the need for more expensive peak load units.

PTES	BTES	ATES
<ul style="list-style-type: none"> • High storage capacity possible • Quick charging and discharging with high capacity • High specific heat capacity • Cheap storage medium with good heat transfer characteristics • Enables stratification 	<ul style="list-style-type: none"> • Requiring relatively small area of land • Very limited visual impact • Expandable • Limited risk of leakages (possible to close one loop) • Closed system • Long lifetime 	<ul style="list-style-type: none"> • Low investment costs • Low operation costs • Small physical footprint • Scalable, easy to expand • Low temperature storage (flexible application) • High storage capacity in each borehole-pair (1.2-1.4 GWh at 10 °C temp. difference and 2000 hours)

Disadvantages:

A generic disadvantage of PTES, BTES and ATES is that a suitable site in terms of e.g. soil or groundwater conditions must be available in order to make a seasonal storage possible.

PTES	BTES	ATES
<ul style="list-style-type: none"> • Requiring a relatively large area of land • Risk of difficult establishment (excavation) due to climatic conditions (rainfall) 	<ul style="list-style-type: none"> • Unknown sub-surface conditions (risk of higher investment costs) • Risk of heat loss due to ground water flow • Buffer tank required 	<ul style="list-style-type: none"> • Risk of thermal short circuit of ground water • Several parameters influence the feasibility • Low storage temperatures (20°C)

<ul style="list-style-type: none"> • Availability of site can be crucial for feasibility • Vulnerable liner and insulation materials, resulting in a risk of leakages, if not treated properly 	<ul style="list-style-type: none"> • Application of heat pump required • Slow charging and discharging 	<ul style="list-style-type: none"> • Open system (direct use of ground water in aquifer)
------------------------------------------------------------------------------------------------------------------------------------------------------------------------------------------------------------------------	--------------------------------------------------------------------------------------------------------------------------------	---------------------------------------------------------------------------------------------------------

Environment

- For PTES and BTES, there is the general risk of leakage of treated water.
- For especially ATES and BTES, there is a risk of heating of ground water surrounding the storage. Heating the aquifers to more than the legal 20°C (average temperature) may result in bacterial growth.
- If not planned properly, PTES can have a substantial visual impact on the surrounding landscape. This may be addressed and minimized in the design phase.

Research and development objectives

A general research and development objective is the improvement of modelling of seasonal heat storages in order to improve the planning security in investment decisions [5].

PTES

- Improvement of liners that can withstand a storage temperature of 90°C all year round. Current liners are built for short storage periods at max. temperature (approx. 90°C), e.g. in relation to solar thermal production peaks in the summer, and a rapid decrease in the storage temperature in the beginning of the heating season. The expected lifetime of current liners at constant storage temperature of 90°C is 3 years only. Although, in the SUNSTORE 3 project, 20 years with a max. storage temperature of 90°C, cf. the operation scheme as stated above, is guaranteed. Verification of liner lifetimes is required, e.g. through an accelerated test.
- Higher temperatures will improve the possibilities for application. Most PTES of today are in combination with solar thermal. In the future large scale PTES in the large district heating systems would require more hours with temperatures of 90°C because they store heat from waste incineration and industries and works as buffer storages for CHPs adding flexibility to the electricity production.
- Further development of insulated lids, moisture resistant at high temperature levels.
- Low-cost PTES for low temperature heat sources. Heat source for heat pumps, utilisation of the produced cooling for process cooling.

In conclusion, developing liner materials that are resistant to high temperatures and moisture-resistant insulation materials over long periods are key focus areas.

BTES

- Monitoring of key parameters at the BTES pilot plant in Brædstrup.
- Full-scale BTES, expected to be competitive with PTES, considering expected longer lifetime than PTES.

- Investigation of BTES established at locations with higher level of ground water (non-flowing). Location in water-saturated soil would imply a higher heat conductivity. Location of PTES in these areas is expensive – hence BTES could be a more feasible solution.

ATES

- High temperature storage in ATES requires more research in order to ensure reliable operation (low temperature storage in ATES is more mature, and is feasible and already proven in stable operation)
- Development of replicable screening program for suitable sites for ATES (e.g. methods to easily identify relevant aquifers, including information regarding e.g. flow. The tool could also be applied in relation to PTES.
- Further investigation of critical flow rates and heat loss in ATES and BTES.

Storage in geothermal reservoirs

Seasonal heat storage in geothermal reservoirs is being investigated in Denmark, including investigations of the selection of suitable geological formations, identification of risks associated to heat storage and determination of a suitable injection strategy [4, 7].

Examples of Market Standard Technology

In all examples prices are for the storage and related work and preparation, excluding heat pumps, heat exchangers and pipes connecting to the district heating system.

PTES

Denmark is a front-runner for PTES for district heating systems. Key data for a number of Danish seasonal heat storages are presented in Table 1.

PTES	Ottrup-gård	SUNSTORE 2 Marstal	SUNSTORE 3 Dronninglund	SUNSTORE 4 Marstal	Vojens	Gram	Toftlund
Project type*	Demonstration project				Commercial project		
Year of construction	1993-95	2003	2013	2011-12	2014-15	2014-15	2016-17
Size, m ³ (water)	1,500	10,000	60,000	75,000	210,000	125,000	85,000
Price, DKK million	1.68	5.0	17	19.9	37.3	32.2	30.6
Price, DKK/m ³	1,120	500	283	266	177	257	359
Price, DKK/kWh	38.6	7.8	3.1	3.3	3.06	3.18	4.54
Temp. difference, °C	35-60	35-90	10-89	17-88	40-90	20-90	20-90
Capacity, MWh	43.5	638	5,400	6,000	12,180	12,125	6,885
Charging and discharging cap. kW	390	6,510	26,100	10,500	38,500	30,000	22,000
Calc. heat loss, total, MWh/y	85	402	1,602	2,475	5,500	4,024	1,900
Measured heat loss, MWh/y [#]	70		1,175	2,927			

Table 1: Key data for seven Danish PTES [1, 13, 14, 16]. Heat loss data for Sunstore 3 from [10]

*Ottrupgård and the four sunstore projects was build as demonstration projects, whereas the three remaining are commercial. There is no measured heat loss from the three commercial projects.

[#]measured data for 1998-2001 (Pilot storage in Ottrupgård) [14], 2013 (Marstal) and 2014 (Dronninglund)

Regarding the measurement of heat loss data, it must be mentioned that the presented losses are calculated based on the differences in measurements at intake, PTES content and outtake.

BTES

There is currently one BTES in operation in a Danish district heating system (Brædstrup).

BTES	Drake Landing (Otokoks)	Crailsheim	Brødstrup
Year of construction	2006-07	2008	2011-12
Size, m ³ (soil)	34,000	37,500	19,000
Price, DKK million	3.37	3.9	1.9
Price, DKK/kWh	4.8	3.4	4.9
Number of boreholes	144		48
Depth, m	35		45
Temperature range, °C	35-65	20-70	12-50
Capacity (calc.), MWh	700	1,135	400
Charging and discharging cap. kW			300-600
Heat loss 1. Year, calc., MWh/y	280	305	148
Measured heat loss, MWh/y*			90

Table 2: Key data for BTES in three examples. The heat loss for Drake Landing is measured in year 4 [1]

*Measured for 2014-16 [14]

ATES

There is currently one ATES in operation in a Danish district heating system.

ATES	Bjerringbro
Year of construction	2013
T _{return} , °C	17
T _{forward} , °C	9
Capacity, kW	1,500
Temperature difference, heat, °C	8
Size, m ³ /h	160
Price, DKK million	19
Price, DKK/m ³ water	75-150
Price, DKK/kW	5,000-7,000

Table 3: Characteristics of the only ATES in Denmark in operation in relation to a district heating network. The price pr. kW is excluding transmission pipelines (the total price is DKK 12,000-13,000) [1].

Prediction of performance and costs

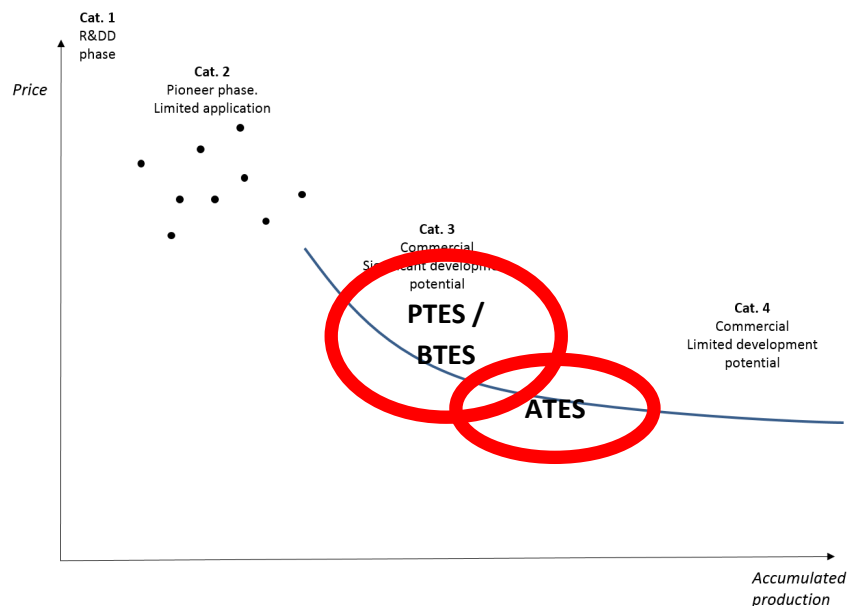

Figure 7: Technological development phases. Correlation between accumulated production volume (MW) and price.

PTES

Crucial knowledge regarding PTES in the context of Danish district heating systems has been gathered through the last decade. This makes it possible to avoid mistakes in the design and operation phase. Thus, PTES are categorized as “early category 3” as the key development potentials lie in increased standardization in work procedures as well as the development of high temperature resistant liners at feasible prices, which is to be seen as improvement of existing designs.

BTES

The one demonstration plant in Denmark (Brædstrup – pilot project) is evaluated very positively as a technical solution. However, no full-scale storage is yet implemented in Danish district heating systems. Further development of BTES is expected through means of standardization of processes and improved modelling of the energy system, resulting in optimized storages for the given system.

ATES

ATES is a well-proven technology in e.g. Sweden and The Netherlands, primarily for cooling of commercial buildings and alike. In the context of Danish district heating, it is still a niche technology. However, as many key assumptions and knowledge about the technology can be adjusted to the Danish context, ATES is assumed to be in development category 3, as there is yet only limited locally embedded expertise.

Uncertainty

The above is based on available information regarding the development of technical solutions in PTES, BTES and ATES. Hence the uncertainty as to the state-of-the-art data is very low. However, the results are sensible to the stated circumstances, system integration etc. I.e. the data can only be applied to the stated limitations as to e.g. soil conditions (soil material, absence of flowing groundwater etc.).

Additional remarks

Under Danish climatic conditions seasonal storage for solar heat typically requires 0.3-2 m³ store volume per m² solar collector, with solar heat contributing 20-40 % of the total heat load (cf. technology element Solar district heating in this Technology Data Catalogue). For systems with higher solar fraction, the marginal additional storage volume needs be about 4 m³ per m² [5 & 9].

Quantitative description

Technology	Pit Thermal Energy Storage (PTES)										
	2015	2020	2030	2040	2050	Uncertainty (2020)		Uncertainty (2050)		Note	Ref
Energy/technical data						Lower	Upper	Lower	Upper		
Form of energy stored	Heat										
Application	System										
Energy storage capacity for one unit (MWh)	4,500	4,500	4,500	4,500	4,500	4,500	4,500	4,500	4,500		
Output capacity for one unit (MW)	30	30	30	30	30	30	30	30	30	A	5
Input capacity for one unit (MW)	30	30	30	30	30	30	30	30	30	A	5
Round trip efficiency (%)	70	70	70	70	70	60	80	60	80	B	1, 5, 14
- Charge efficiency (%)	100	100	100	100	100	100	100	100	100	B	
- Discharge efficiency (%)	100	100	100	100	100	100	100	100	100	B	
Energy losses during storage (K / day)	0.08	0.08	0.08	0.08	0.08	0.04	0.1	0.04	0.1	B	12
Auxiliary electricity consumption (% of output)	2	2	2	2	2	2	2	2	2	C	5
Forced outage (%)	0	0	0	0	0	0	0	0	0		
Planned outage (weeks per year)	1	1	1	1	1	1	1	1	1		
Technical lifetime (years)	20	20	25	25	25	15	25	20	30	D	
Construction time (years)	1	1	1	1	1	1	1	1	1	E	
Financial data											
Specific investment (M€2015 / GWh _{Capacity})	0.58	0.58	0.54	0.51	0.47	0.47	0.62	0.39	0.54	F	5
- hereof equipment (%)	75	75	75	75	75	75	75	75	75		5
- hereof installation (%)	25	25	25	25	25	25	25	25	25		5
Fixed O&M (€2015/MWh _{Capacity} /year)	3	3	3	3	3	3	3	3	3	G	1, 5
Variable O&M (€2015/MWh _{Output})	0	0	0	0	0	0	0	0	0	G	1, 5
Technology specific data											
Storage volume for one unit (m ³)	70,000	70,000	70,000	70,000	70,000	70,000	70,000	70,000	70,000		
Storage medium	Water										
Max. storage temperature, hot(°C)	90	90	90	90	90	90	90	90	90		
Storage temperature, discharged (°C)	35	35	35	35	35	35	35	35	35	H	

Notes:

- A The charge/discharge capacity corresponds to an example where a solar fraction of 40 % was desired. Other input/output capacities (also relative to storage capacity) may occur for other purposes. Measurements from SUNSTORE 3 show approx. 80 % efficiency for a storage with heat pump.
- B Values in the table are without a heat pump. The storage loss depends on several parameters, such as store volume, insulation, whether a heat pump is part of the system etc. Round trip efficiency of approx. 80 % when applying a heat pump for cooling to 10 °C. (Dis-)charge losses 0 cf. Direct use of water from the connected district heating grid (without exchanger).
Losses are dependent on the temperature of the storage. 0.08 K/day at average temperature of approx. 78 °C, falling to 0.04 K/day at 56°C.
- C Approx. 100 MWh/year for pumps, at 2,000 fullload hours for the pumps, considering one full cycle
- D Current max. Technical lifetime for liners.
- E Excl. Extensive planning phase with possibly Environmental Impact Assessment etc. Careful timing of steps is mandatory, as the steps of excavation, building, installation of liners etc. Can be done within one summer. If not, the construction time expands to approx. 2 years.
- F Estimated from the cost of the 7 Danish plants, described in the text and due to effects of economy of scale, the total costs of a PTES in 2015 could be described in a formula: $Cost [M€] = 0.9 + 2.44 \cdot 10^{-5} \cdot V$, with V being the volume in m³. Corresponding to 37€/m³ at 70,000 m³ and 0.58 M€ per GWh_{Capacity}.
The costs are based on decent soil conditions, i.e. sand ground and not e.g. heavy clay.
The costs can be split as follows:
15 % Excavation and reinstallation of soil
35 % Bottom and side surfaces & insulation material
20 % Installation (of primarily liner)
15 % Piping
15 % Water (incl. desalination)
- G The Fixed O&M is set according to capacity of the Energy Storage specified in the top of the table. Corresponding to approx. 13,000 €/storage/year for e.g. divers for inspection, adding of possible leakages and minor fixes.
- H Cooling to lower temperatures is only possible when a heat pump is used to chill the PTES.
- I Total efficiency during a one year cycle, including losses during storage period.

References

- PlanEnergi, Teknologisk Institut, GEO & Grøn Energi, 2013, *Udredning vedrørende varmelagrings teknologier og store varmepumper til brug i fjernvarmesystemer*
- PlanEnergi 2017, based on latest three projects and tender material for two planned PTES (2017/18)
- Danish Energy Agency, 1988, Energy Technology Catalogue 38.01
- Schmidt, Sørensen (2018). Monitoring Results from Large Scale Heat storages for District Heating in Denmark. 14th International Conference on Energy Storage, 25-28 April 2018, Adana, Turkey

References

- [1] PlanEnergi, Teknologisk Institut, GEO & Grøn Energi, 2013, Udredning vedrørende varmelagringssteknologier og store varmepumper til brug i fjernvarmesystemer
- [2] Ellehauge & Kildemoes and COWI, 2007, Seasonal heat storages in district heating networks. A project (Preheat) funded by Intelligent Energy – Europe and the Danish Transmission System Operator Energinet.dk.
- [3] Mangold, 2007, Seasonal Heat Storage. Pilot projects and experiences in Germany, (www.solites.de). Presentation at the PREHEAT Symposium at Intersolar 2007, Freiburg, Germany, June 2007.
- [4] Henninger, Ellehauge et. al., 2008, Heat Storage Technologies Markets, Actors, Potentials, from the PREHEAT project, funded by the Intelligent Energy – Europe programme (www.preheat.org).
- [5] PlanEnergi (Danish company; www.planenergi.dk), which has been involved in several pit heat storages in Denmark and internationally.
- [6] Schossig, 2008, Technologies for thermal energy storage, presentation at the “Third International Renewable Energy Storage Conference (IRES 2008)”, Berlin, November 2008, Fraunhofer Institut, Solare Energiesysteme.
- [7] “HeHo - Heat Storage in Hot Aquifers”, Four-year research project supported by the Danish Council for Strategic Research (2011-2015).
- [8] Schmidt, 2017, Monitoring results Braedstrup 2016, Solites, Presentation.
- [9] Solar Heating Plants in Denmark, Simon Furbo, Bengt Perers and Federico Bava, Department of Civil Engineering, Technical University of Denmark
- [10] PlanEnergi et. Al., 2015, Sunstore 3, Final Report for EUDP 2009 projects 64009-0043 and 64010-0447.
- [11] Solites, <http://www.solites.de/> Personal communication, 2017
- [12] Danish Energy Agency, 1988, Energy Technology Catalogue 38.01
- [13] Sørensen, P. A. & Schmidt, T. (2018). Design and Construction of Large Scale Heat storages for District Heating in Denmark. 14th International Conference on Energy Storage, 25-28 April 2018, Adana, Turkey
- [14] Schmidt, Sørensen (2018). Monitoring Results from Large Scale Heat storages for District Heating in Denmark. 14th International Conference on Energy Storage, 25-28 April 2018, Adana, Turkey
- [15] Vang Jensen, Morten (2014). Seasonal pit heat storages – Guidelines for design of seasonal pit heat storages, SHC Task 45 Large Systems, Guidelines <http://task45.iea-shc.org/fact-sheets>

[16] Rambøll, consultancy, which has been involved in several pit heat storages in Denmark and internationally.

141 LARGE-SCALE HOT WATER TANKS

Contact information

Danish Energy Agency: Filip Gamborg, fgb@ens.dk

Energinet.dk: Rune Duban Grandal, rdg@energinet.dk

Author: Max Guddat, PlanEnergi

Publication date

November 2018

Amendments after publication date

Date	Ref.	Description

Brief technology description

Thermal storage options can be split into three different technologies [1]:

1. Sensible stores, which use the heat capacity of the storage material – mainly water for its high specific heat content per volume, low cost and non-toxic medium.
2. Latent stores, which make use of the storage material's latent heat during a solid/liquid phase change at a constant temperature.
3. Chemical stores, which use the heat stored in a reversible chemical reaction. Sorption stores, which use the heat of ad- or absorption of a pair of materials such as zeolite-water (adsorption) or water-lithium bromide (absorption), are examples of chemical stores.

The market is dominated by sensible hot water storage vessels due to the qualities, the cost, the simplicity and the versatility of water as a storage medium. Sensible stores may be constructed as steel, concrete or glass-fibre reinforced plastic tanks.

Sensible stores in context of this catalogue are typically insulated on-surface steel-constructions on a concrete foundation. They are connected to a district heating network and supplied with an inlet nozzle at the top and an outlet nozzle at the bottom for charging. The cycle is reversed for discharging. A tank may be supplied with more nozzles than the essential two, to increase the possibility of layering (and hence more efficient storage of heat less than nominal storage capacity).

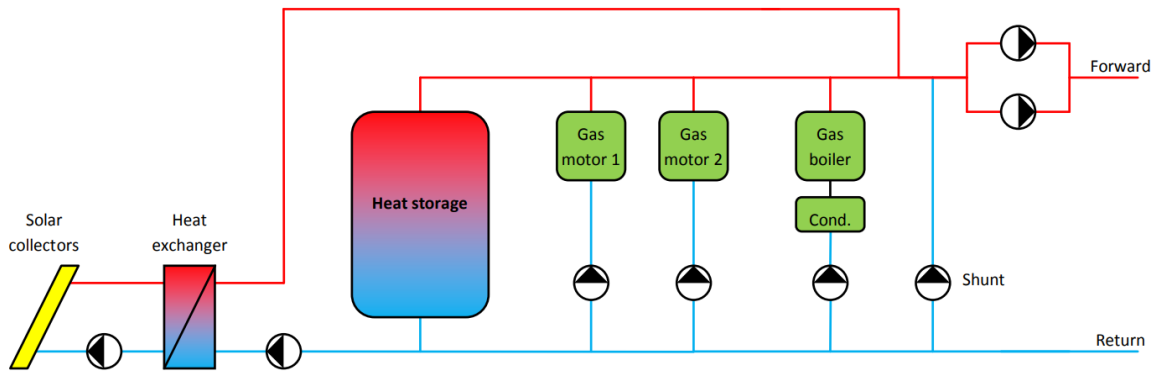

Figure 1: Principal scheme of the hydraulic integration of a large scale water tank in a simple district heating system [6].

Application in Danish District Heating Systems

In recent decades, steel tanks have been used as short-term storage in connection with most combined heat and power plants and for almost all biomass-heating plants in Denmark to control operation and to reduce emissions. Most of the installed tanks at small-scale CHP-plants were designed for operation of the CHP-plants according to the 3-part electricity tariff, which no longer applies. Water tanks are also applied in larger district heating systems, supplied by centralised CHP-plants, and in district heating systems with heat-only heat production. The application of water tanks is changing from a role defined by the demand of the electricity market to facilitating fluctuating renewable energy production e.g. solar thermal. [2]

The total volume of water tanks in Danish district heating systems was in 2013 approx. 875,000 m³, located on 284 district heating plants [2], with a typical tank capacity being 500-5,000 m³.

To increase energy efficiency in storage systems, it is often chosen to fill the large-scale water tanks with district heating water, i.e. treated water at pH 9.8, which impedes corrosion. Alternatively, tanks can be filled with pH-neutral water, which however necessitates an additional heat exchanger and pressurization of the tank, to avoid corrosion.

Energy efficiency

Steel tanks for hot water storage are a well-established technology. Typically, a steel tank for diurnal use in district heating applications is insulated with about 300 mm insulation (mineral wool), but for long-term storages, 450 mm may be more suitable [3].

The size and height/diameter factor also influence the heat loss. A theoretical calculation of three different sizes (500, 1,000 and 5,000 m³) with a height/diameter factor of 1.8 shows heat losses of 2.1 %, 1.7 % and 1.0 % per week at 90°C water temperature and 0°C outside temperature, 10 m/s wind and 300 mm insulation [2].

Input

Hot water, max. approx. 95°C. If the tank is pressurized higher temperature can be obtained. Eg. 100-120°C

Output

Hot water.

Typical capacities

Typical capacities vary by the district heating plant. Sizes of 500-5,000 m³ are very common for this purpose in a Danish district heating context, with an average tank size of approx. 3,000 m³. [2]

The estimated energy capacity in the Danish district heating system in 2017 is 56 GWh, based on an assumption of a temperature difference of 55K. However, in practice, only approximately 90 % can be utilized, and the available total capacity is therefore approximately 50 GWh. [2]

The capacity of the tanks in terms of energy depends on the temperature difference and therefore also the temperature levels. The change of production technology towards e.g. heat pumps and solar thermal results in lower temperatures (e.g. 70-80°C), whereas the temperature is higher (e.g. 90-100°C) if the heat is produced on e.g. a CHP-plant. Hence, the capacity of the tanks in terms of energy is likely to be reduced, depending on the heat production technology. [2]

Typical Storage Period

The typical storage period depends on the heat demand and varies from a few hours to approx. two weeks. Additionally, water tanks can be used for covering peak demands, i.e. to cover morning and evening peaks by charging the tank in the night and throughout the day.

In smaller district energy systems, large-scale water tanks can be used for seasonal storage, when the desired storage capacity is too small to necessitate e.g. a pit thermal energy storage (cf. Seasonal Heat Storage, chapter 60). For storages up to approx. 10,000 m³ storage volume, steel tanks have generally proven to be more cost-effective than e.g. small-scale pit heat storages.

Regulation ability and other system services

N.A.

Space Requirements

With a typical ratio height:diameter of 1:1.5-2.5 the space requirements for a steel tank with 300 mm insulation, 55K temperature difference, 40 m² for piping and service area and 90 % availability are as follows:

Storage volume	m ³	1000		3000		5000	
Storage capacity	MWh	58		173		288	
Ratio h:D		1.5	2.5	1.5	2.5	1.5	2.5
Space requirements	m ²	71.9	67.3	85.1	78.4	93.1	85.1
Space requirements	m ² /MWh	1.25	1.17	0.49	0.45	0.32	0.30

Table 1: Space requirements for examples.

Advantages/disadvantages

Advantages:

- Well-known technology
- Increases short-term flexibility of operation in district heating plants

- Can in some cases keep the pressure in district heating systems
- Cost-effective storage of heat
 - The most cost-effective storage medium for thermal energy storage at low (0 - 20°C) to medium (20 - 100°C) temperature is water, because it is relatively cheap, environmental friendly and convenient material. Furthermore, water has, compared to other common storage materials, a very high specific heat capacity as well as a very high volumetric heat capacity and possibility of temperature stratification.
- Low investment cost

Disadvantages:

- Space requirements
- Energy losses
- N₂ or steam is necessary as protection against oxygen for corrosion protection in pressure less tanks

Environment

Large tanks may have an influence on the surrounding landscape. However, as they are typically installed next to district heating plants, this influence is assessed to only have little impact.

The risk of leakage of treated water is a possible environmental threat. However, major leakages happen very seldom.

Research and development perspectives

The research and development of large steel tanks in Danish district heating systems is assessed to be limited to adjusted operation strategies of the existing technological solutions. This includes:

- Operation at lower temperatures and temperature differences in district heating grids, resulting in lower energy content per water volume.
- Use of large tanks for cooling storage.
- Using one tank for storage at different temperature levels to accommodate the optimal supply temperatures for heating and cooling purposes.

Examples of Market Standard Technology

Large scale water tanks are installed in approx. 280 district heating systems [2] and are thus widely applied.

Prediction of performance and costs

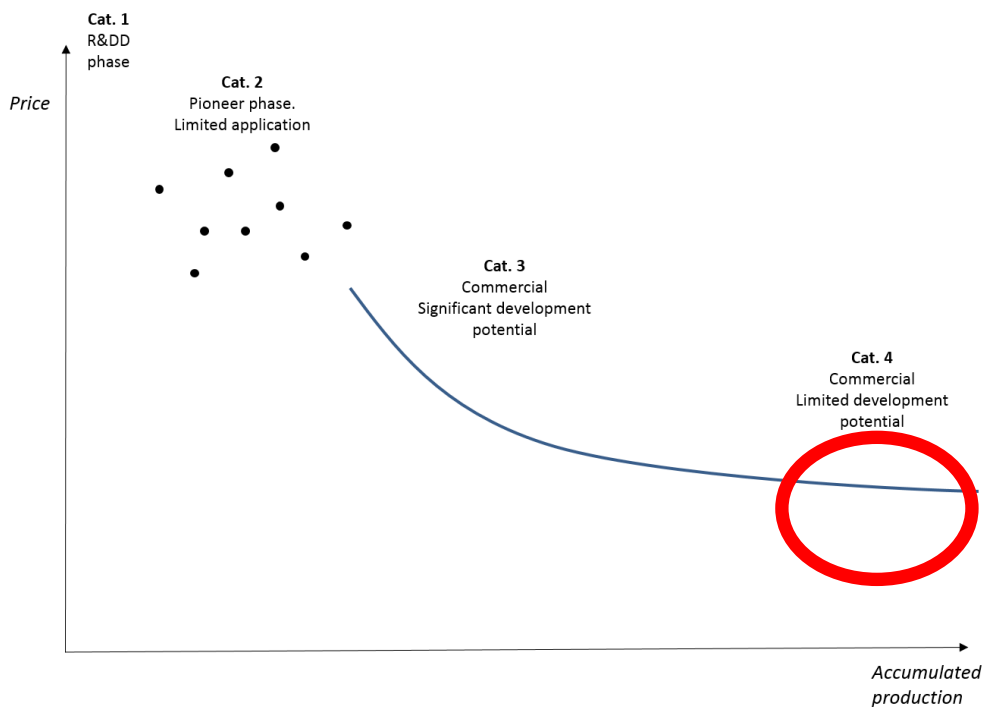

Figure 2: Technological development phases. Correlation between accumulated production volume (MW) and price.

Large-scale water tanks are a mature and proven technology; hence, the technology is in category 4 “Commercial”. The development potential comprises storage at different temperature levels.

Additional remarks

Economy of scale

Large-scale water tanks are characterized by a considerable effect of economy of scale. Cf. Figure 3, the unit price is best described in an exponential formula, as stated in note H in Section 0. However, as Figure 3 only indicates the change in CAPEX for the given sizes, it must be noted that the optimal size of a water tank must be evaluated over the total lifetime of the tank, including the benefits for operation flexibility it may contribute with in the specific energy system that the tank is installed in.

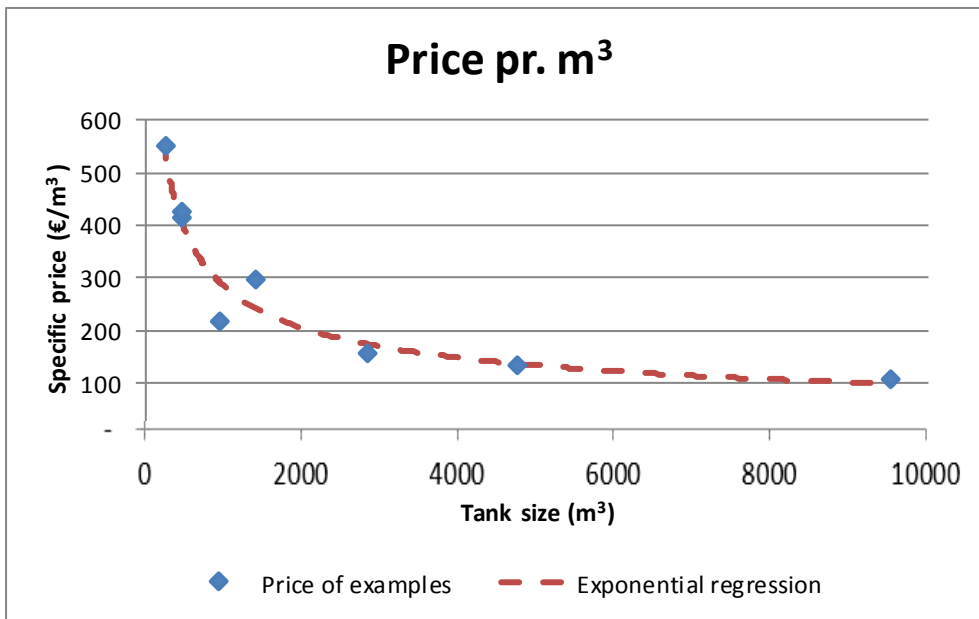

Figure 3: Specific price pr. m³ by total size of tank, incl. foundation [2 & 4].

Quantitative description

Technology	Large-Scale Hot Water Tanks (steel)										
	2015	2020	2030	2040	2050	Uncertainty (2020)		Uncertainty (2050)		Note	Ref
Energy/technical data						Lower	Upper	Lower	Upper		
Form of energy stored	Heat										
Application	System										
Energy storage capacity for one unit (MWh)	175	175	175	175	175	45	315	45	315	A	
Output capacity for one unit (MW)	2.9	2.9	2.9	2.9	2.9	0.8	5.3	0.8	5.3	B	7
Input capacity for one unit (MW)	2.9	2.9	2.9	2.9	2.9	0.8	5.3	0.8	5.3	B	7
Round trip efficiency (%)	98	98	98	98	98	96	99	96	99	J	2
- Charge efficiency (%)	100	100	100	100	100	100	100	100	100	C	
- Discharge efficiency (%)	100	100	100	100	100	100	100	100	100		
Energy losses during storage (% / day)	0.2	0.2	0.2	0.2	0.2	0.14	0.24	0.14	0.24		2
Auxiliary electricity consumption (% of output)	1	1	1	1	1	0	1	0	1	D	7
Forced outage (%)	0	0	0	0	0	0	3	0	3		7
Planned outage (weeks per year)	1	1	1	1	1	0	4	0	4	E	7
Technical lifetime (years)	40	40	40	40	40	30	50	30	50	F	2
Construction time (years)	0.5	0.5	0.5	0.5	0.5	0.5	1.0	0.5	1.0	G	7
Financial data											
Specific investment (M€2015 / GWh _{Capacity})	3.0	3.0	3.0	3.0	3.0	2.2	8.0	2.2	8.0	H	2, 7
- hereof equipment (%)	70	70	70	70	70	70	70	70	70		7
- hereof installation (%)	30	30	30	30	30	30	30	30	30		7
Fixed O&M (€2015/MWh _{Capacity} /year)	8.6	8.6	8.6	8.6	8.6	5	33	5	33	E	7
Variable O&M (€2015/MWh _{Output})	0	0	0	0	0	0	0	0	0	I	7
Technology specific data											
Tank volume of example (m ³)	3,000	3,000	3,000	3,000	3,000	1,500	5,000	1,500	5,000		
Typical temperature difference in storage (hot/cold, K)	55	55	55	55	55	30	60	30	60		

Notes:

- A Considering a temperature difference of 55K (hot/cold), 90% availability.
- B Considering a full charging cycle of 60 hours (2.5 days), cf. traditional application of steel tanks in Danish DH-plants. The capacity is practically limited by the available pipe dimensions for charge/discharge and the number of installed valves in the tank (in order to increase flow at same low turbulence).
- C As tanks are typically connected directly to the district heating supply/return hydraulic system, there is no loss due to the dis-/charging.
- D Less than 1 % of the stored energy for circulation pumps and N₂-production.
- E The Fixed O&M is set according to capacity of the Energy Storage specified in the top of the table. Corresponding to approx. 1500 €/tank/year. Typically limited to one inspection/year using a diver, if any at all.
- F Primarily limited by the extent to which the system is held corrosion-free.
- G Installation period for approval by authorities, site preparation, welding, connection, cleansing, initial filling and insulation. Additional delivery time for steel may apply.
- H CAPEX for large-scale water tanks are best described in a formula, due to significant impact of economy of scale. For 2015, the following equation is used to estimate the CAPEX in € pr. m³, based on data as presented in Figure 61.2: $7450 \cdot V^{(-0.47)}$, V=Water Volume of tank in m³. Development in CAPEX depends primarily on the development in steel prices.
- I Only variable O&M is electricity consumption for pumps and N₂-production as specified above.
- J Total efficiency during a one year cycle, including losses during storage period.

References:

- 2 PlanEnergi, Teknologisk Institut, GEO & Grøn Energi, 2013, Udredning vedrørende varmelagrings teknologier og store varmepumper til brug i fjern-
- 7 PlanEnergi, references from various projects in Danish district heating systems.

References

- [1] Energinet.dk, Energistyrelsen, 2015, Technology Data for Energy Plants – Generation of Electricity and District Heating, Energy Storage and Energy Carrier Generation and Conversion. 2015-version of the catalogue at hand.
- [2] PlanEnergi, Teknologisk Institut, GEO & Grøn Energi, 2013, Udredning vedrørende varmelagringsteknologier og store varmepumper til brug i fjernvarmesystemer, November 2013, available at https://ens.dk/sites/ens.dk/files/Forskning_og_udvikling/udredning_om_varmelagringsteknologier_og_store_varmepumper_i_fjernvarmesystemet_nov_2013.pdf [Last viewed 18.07.18]
- [3] Danish District Heating Association, January 2012.
- [4] Grøn Energi, 2017, Personal Communication
- [5] Pedersen, AS, Elmegaard, B, Christensen, CH et. al. 2014, Status and recommendations for RD&D on energy storage technologies in a Danish context, 2014
- [6] Sørensen P.A., Solar heat combined with other fuels, Solar District Heating Guidelines Fact Sheet 2.1, August 2012, available at http://www.euroheat.org/wp-content/uploads/2016/04/SDHtake-off_SDH_Guidelines.pdf [last viewed 18.07.18]
- [7] PlanEnergi, references from various projects in Danish district heating systems.

142 SMALL-SCALE HOT WATER TANKS

Contact information

Danish Energy Agency: Filip Gamborg, fgb@ens.dk

Energinet.dk: Rune Duban Grandal, rdg@energinet.dk

Author: Max Guddat, PlanEnergi

Publication date

May 2012

Amendments after publication date

Date	Ref.	Description
August 2019		Major update of text and data

Brief technology description

Hot water storage vessels in private homes are used for different purposes:

- Domestic hot water; to ensure sufficient flow for high demands such as showers and filling bath tubs. Basically a drum filled with water and equipped with a heating mechanism on the bottom or inside.
- Space heating; to increase operating periods for e.g. heat pumps and biomass boilers and hence facilitate more efficient operation of these technologies.
- As storages to facilitate shift load storage to capture the cheaper, off-peak electricity and using it at other times, effectively shifting portions of peak load to off-peak hours. Reshaping the load curve improves the utility's capacity factor and, by extension, its financial health.

For solar domestic hot water, the heat exchanger from the solar collectors is usually placed in the bottom of the store, cf. the lower coil in figure 1. Often, an extra coil is placed in the top of the store to raise the temperature by an additional heat source, when needed.

For shift load storage there is no need to have heat exchanger coils, if for example the store is a component in a closed circuit with a heat pump.

In Denmark, hot water vessels are typically made in steel, corrosion protected by enamel and an anode. Other countries also use stainless steel, which is generally found too costly in Denmark [1].

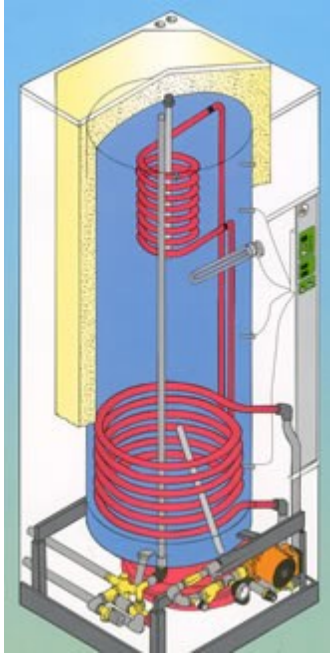

Figure 1: Typical domestic hot water store used for solar heating [1].

Input

Hot water.

Output

Hot water.

Typical capacities

To store domestic hot water, the volume is often 60 - 160 litres for a single-family dwelling, depending primarily on the heat source and the hot tap water demand in the building.

For domestic solar water heaters, with no seasonal storage, the store volume needs to be around 50-65 litres per m² solar collector [4].

If a large volume is needed, the limit is often determined by the available space, e.g. in the laundry room of the dwelling. A cupboard solution, 60 by 60 cm horizontal and 2+ metres high, has a water volume of up to 300 litres due to the space utilised for insulation [4; 5].

Typical Storage Period

The typical storage period is a few hours, facilitating appropriate operation of the heat production capacity, with close-to-constant operation of the heat source, at varying heat loads.

Regulation ability and other system services

N.A.

Space Requirements

Small buffer tanks come in different shapes and forms. The compact units (up to approx. 2-300 L) are usually designed as cabinet solutions (60x60 cm horizontal), to fit in utility rooms etc. Larger buffer tanks have a slightly larger horizontal (circular) footprint with a diameter of approx. 80-100 cm [5].

Advantages/disadvantages

Advantages:

- Can be used as storages to facilitate shift load storage to capture the cheaper, off-peak electricity and using it at other times, effectively shifting portions of peak load to off-peak hours. Reshaping the load curve improves the utility's capacity factor and, by extension, its financial health. In the same way, decentralized production units may be operated more efficiently when combined with a storage.
- Cheap and easy to produce (millions of 50-1,000 L produced internationally each year)
- Well proven technology

Disadvantages:

- Comparably large footprint, partly due to insulation.
- Depending on storage temperatures, legionella bacteria inside the tank may be an issue
- May cause high return temperature in district heating systems, which results in higher energy losses. Furthermore, the possibilities for lowering temperatures are weakened in traditional systems, during the summer time, and generally in low temperature district heating systems, due to the higher flow temperatures required compared to heat exchanger sub stations.

Environment

There is no local environmental impact from small-scale water tanks.

Research and development objectives

Tanks with high storage density and reduced losses are key to an increased solar heat share in households. Austrian research institute AEE INTEC [3] has recently inaugurated a pilot research facility. The heart of the test facility is two low-pressure vessels filled with 750 kg of zeolite beads or spheres each.

The storage density is 180 kWh/m^3 , which is approx. 4-5 more than that of regular hot water buffer tanks (depending on the temperatures in the storages).



Challenges remain and one of them is the costs of zeolite spheres. Despite zeolites being an important component in other industries, the market price for energy purposes is comparably high, making zeolite-storages unfeasible at current conditions [2].

Figure 2: Zeolite storage at AAE INTEC. [3]

Improvements of storages using water as storage medium are primarily within the area of intelligent storage operation through flexible storage temperatures in (parts of) the storage tanks. For this please refer to e.g. Cabeza et. al, 2014 [7].

Examples of Market Standard Technology

Small-scale water tanks are installed in most buildings with biomass boilers, heat pumps and/or solar thermal and many buildings with other heating sources.

Assumptions and perspectives for further development

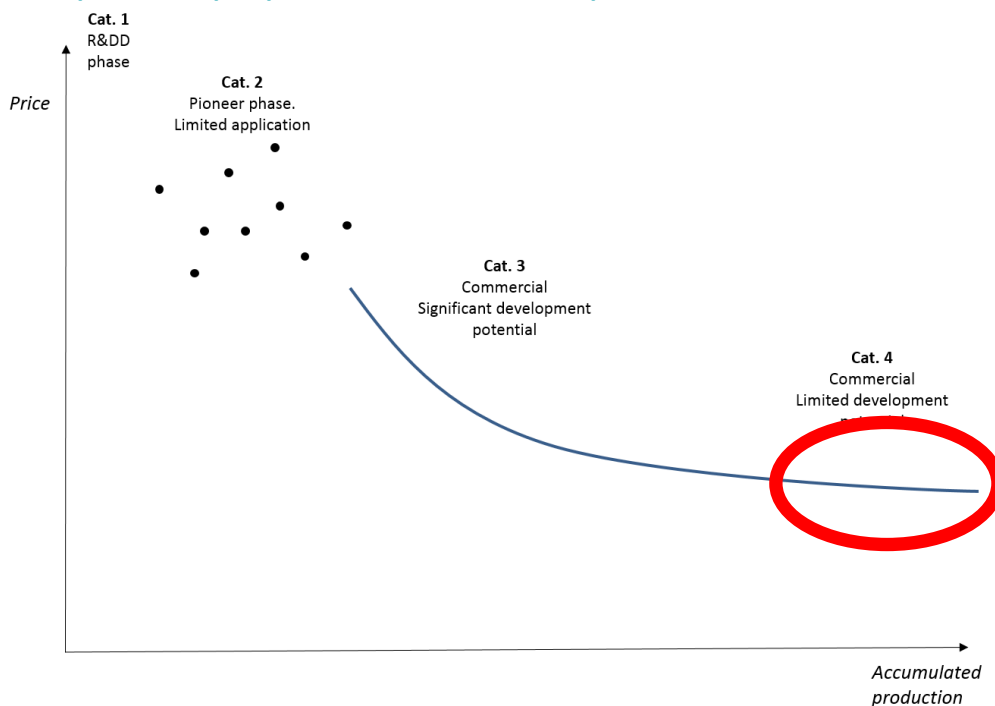

Figure 0.3: Technological development phases. Correlation between accumulated production volume (MW) and price.

Traditional water tanks are in category 4 “Commercial”, i.e. it is mature technology and there is only a limited development potential.

Additional remarks

The heat loss coefficient for a 90 liter store insulated by 5 cm PUR-foam is about 2.1 J/s per K, and about 2.9 J/s per K, if the volume is 300 liters. The coefficient is doubled, when the insulation thickness is halved.

Further information / additional reading:

- “Potentiale og muligheder for fleksibelt elforbrug med særligt fokus på individuelle varmepumper”(Opportunities for flexible electricity demand using heat pumps in private homes), Energinet.dk, January 2011.

Quantitative description

Technology	Small-Scale Hot Water Tanks (steel)										
	2015	2020	2030	2040	2050	Uncertainty (2020)		Uncertainty (2050)		Note	Ref
Energy/technical data						Lower	Upper	Lower	Upper		
Form of energy stored	Heat										
Application	Local										
Energy storage capacity for one unit (kWh)	3	3	3	3	3	2	19	2	19	A	
Output capacity for one unit (kW)	20	20	20	20	20	10	40	10	40		5
Input capacity for one unit (kW)	20	20	20	20	20	10	40	10	40		5
Round trip efficiency (%)	N/A	N/A	N/A	N/A	N/A	N/A	N/A	N/A	N/A	J	
- Charge efficiency (%)	100	100	100	100	100	100	100	100	100	B	
- Discharge efficiency (%)	100	100	100	100	100	100	100	100	100		
Energy losses during storage (% / hour)	2.1	2.1	2.1	2.1	2.1	2.5	1	2.5	1	I	
Auxiliary electricity consumption (% of output)	1	1	1	1	1	0	1	0	1	C	
Forced outage (%)	0	0	0	0	0	0	3	0	3		5
Planned outage (weeks per year)	1	1	1	1	1	0	4	0	4	D	
Technical lifetime (years)	30	30	30	30	30	15	50	15	50	E	5
Construction time (years)	0	0	0	0	0	0	0	0	0	F	6
Regulation ability											
Primary regulation (% per 30 sec)											
Secondary regulation (% per minute)											
Financial data											
Specific investment (€2015 per kWh)	410	410	410	410	410	510	130	510	130	F,G,L	5, 6
- hereof equipment (%)	50	50	50	50	50	40	35	40	35		6
- hereof installation (%)	50	50	50	50	50	60	65	60	65		6
Fixed O&M (€2015/tank/year)	50	50	50	50	50	25	80	25	80	D	5, 6
Variable O&M (€2015/MWh)	0.6	0.7	1	1.2	1.2	0	0.7	0	1.2	H	6
- of which is electricity costs (€/MWh)	0.6	0.7	1	1.2	1.2	0	0.7	0	1.2	K	
- of which is other O&M costs (€/MWh)	0	0	0	0	0	0	0	0	0		
Technology specific data											
Efficiency at typical cycle period (%)	92	92	92	92	92	97	90	97	90	I, B	
Tank volume of example (l)	90	90	90	90	90	50	300	50	300		
Typical temperature difference in storage (hot/cold, K)	30	30	30	30	30	30	60	30	60	A	8

Notes:

- A Considering a temperature difference of 30K (hot/cold), cf. DS12897:2016 [8], and 60K for large tanks, typically for solar thermal applications.
- B As tanks are typically connected directly to the hydraulic heating system of a building, there is no loss due to the dis-/charging. The heat loss of the tank will typically be utilised as spatial heating, if the tank is mounted inside the building.

- C Less than 1 % of the stored energy for circulation pumps.
- D Typically limited to replacement of the anode for every 3 years, potentially the control unit or valves and fittings.
- E Primarily limited by the extent to which the system is held corrosion-free (the enamelling is held undamaged).
- F Installation period assessed to be 3-8 hours each for two skilled workers, i.e. the construction site is cleared/prepared, varying by the tank size.
- G CAPEX cf. a stand-alone cabinet-solution, mounted, site-clearance/preparation and removal of existing heating source/storage not included. Cost for fittings etc. approx. 10 % of total CAPEX. Additional investment for electric heater of approx. 100 € may be added if necessary.
- H Only variable O&M is electricity consumption for pumps as specified above.
 - I Considering a heat loss of 60 W at temperature 65/35°C in the storage and 20°C ambient for the 90 l unit. Considering an idle/discharging cycle of total 4 hours.
 - J Round trip efficiency is not applicable for seasonal storage.
 - K The cost of auxiliary electricity consumption is calculated using the following electricity prices in €/MWh: 2015: 63, 2020: 69, 2030: 101, 2040: 117, 2050: 117. These prices include production costs and transport tariffs, but not any taxes or subsidies for renewable energy.
 - L CAPEX is related to storage volume. I.e. an increase of temperature difference in storage yields a lower specific investment per MWh.

References:

- 5 Metro-Therm A/S, 2019, sales department and homepage.
- 6 PlanEnergi, 2019
- 8 Danish standard, "Specification for indirectly heated unvented (closed) storage water heaters", DS12897:2016

150 UNDERGROUND STORAGE OF GAS

This chapter has been moved from the previous Technology Data Catalogue for Electricity and district heating production from May 2012. Therefore, the text and data sheets do not follow the same guidelines as the remainder of the catalogue.

Brief technology description

Large volumes of gas may be stored in underground reservoirs or as liquefied gas in tanks (e.g. LNG - liquefied natural gas). This technology element is about underground storage, of which there are three principal types:

Depleted gas reservoirs are the most prominent and common form of underground storage. They are the reservoir formations of natural gas fields that have produced all their economically recoverable gas. The depleted reservoir formation is readily capable of holding injected natural gas. Using such a facility is economically attractive because it allows the re-use, with suitable modification, of the extraction and distribution infrastructure remaining from the productive life of the gas field which reduces the start-up costs. Depleted reservoirs are also attractive because their geological and physical characteristics have already been studied by geologists and petroleum engineers and are usually well known. Consequently, depleted reservoirs are generally the cheapest and easiest to develop, operate, and maintain of the three types of underground storage.

However, off-shore depleted gas fields are generally quite expensive.

Aquifer reservoirs are underground, porous and permeable rock formations that act as natural water reservoirs. In some cases they can be used for natural gas storage. Usually these facilities are operated on a single annual cycle as with depleted reservoirs. The geological and physical characteristics of aquifer formation are not known ahead of time and a significant investment has to go into investigating these and evaluating the aquifer's suitability for natural gas storage.

Salt caverns allow no gas to escape from storage. The walls of a salt cavern are strong and impervious to gas over the lifespan of the storage facility. Once a suitable salt feature is discovered and found to be suitable for the development of a gas storage facility a cavern is created within the salt feature. This is done by the process of cavern leaching. Fresh water is pumped down a borehole into the salt. Some of the salt is dissolved leaving a void and the water, now saline, is pumped back to the surface. The process continues until the cavern is the desired size. Once created, a salt cavern offers an underground natural gas storage

vessel with very high deliverability. Cushion gas requirements are low, typically about 33 percent of total gas capacity.

Input

Underground storage is primarily used for natural gas (almost pure methane, CH₄), but other gasses may also be stored underground.

That may include hydrogen (H₂), but the surface facilities need be designed differently, as hydrogen is much more explosive and also aggressive towards steel structures. The costs of storing hydrogen would be larger, since the heating value per volume is about three times less (cf. Technology element 42).

If biogas (approx. 65 % CH₄ and 35 % CO₂) is to be stored underground, it would be instrumental to remove the CO₂ before storage. This is because stores are always wet, i.e. containing some water, and CO₂ in contact with water becomes acidic, posing potential problems for the surface facilities. Also, the energy density will be increased, when the CO₂ is removed.

Output

Same as input gas, but it will have to be cleaned before usage, e.g. water has to be removed.

Typical capacities

The characteristics of gas storage differ depending on the geological properties of the reservoir, which in turn define their use [2]:

	Depleted field	Aquifer	Salt cavern
Working gas volume ⁴	High	High	Relatively low
Cushion gas	~50 %	~80 %	~30 %
Injection rate*	Low	Low	High
Withdrawal rate*	Low	Low	High

*as compared to working gas volume

Working gas is the volume of gas that can be extracted during an operation of a facility.

Cushion gas (or base gas) is the share of residual gas that needs to be maintained to ensure appropriate reservoir pressurization.

⁴ A depleted field is often above 1 billion m³, an aquifer store from around 0.3 – 0.4 to above 1 billion m³, and salt caverns about 35 – 100 million m³ per cavern. There are several caverns in one store.

Using highly sophisticated technology, depths of up to 3,000 m are made accessible and cavern diameters of 60 to 100 m, heights of several hundred meters, and geometrical volumes of 800,000 m³ and more can be realized today [1].

Regulation ability

The short-term regulation characteristics of an underground gas store are not relevant for the overall gas system, as the gas transmission and distribution pipelines normally have substantial storage capacity (so-called line pack). If, for example, a power plant wishes to start up from zero to full load in a moment, the required gas volume is ready by the gate. The gas pressure in the pipeline will drop a little, much within the operational limits, and the pressure will soon rebuild by drawing gas from other parts of the system, incl. underground stores.

The primary regulation values of underground gas stores are as seasonal stores (gas production is fairly constant, while summer demand is much lower than winter demand) and as back-up supply-security in cases of emergency.

Examples of best available technology

The total gas storage capacity in Europe is around 67 billion m³. Of 125 storage facilities analyzed by Gas Storage Europe, 64 % were depleted fields, 26 % salt caverns, 8 % aquifers and 2 % LNG peak shaving [3].

Example, aquifer reservoir: Stenlille, Denmark. Gas is stored in porous water-saturated sandstone approx. 1.5 km below surface. Total gas volume 1.5 billion m³, working gas 0.6 billion m³.

Example, salt caverns: Lille Torup, Denmark. Gas is stored in 7 caverns 1-1.7 km below ground. Each cavern is 200-300 metres high and 40-60 metres in diameter. Total gas volume 0.7 billion m³, working gas 0.44 billion m³. The store can extract 8 million m³/day and inject about half this flow.

References

- [1] Deep Underground Engineering (www.deep.de).
- [2] "Underground Natural Gas Storage: ensuring a secure and flexible gas supply", presentation by Jean-Marc Leroy, President of Gas Storage Europe (a sub-division of Gas Infrastructure Europe; www.gie.eu.com), January 2011.
- [3] Gas Storage Europe's "Investment Database", February 2010 (www.gie.eu/maps_data/GSE/database/index.asp).

Data sheet

Cavern leaching

Plant for cavern leaching	Mill. €
Total	9.9

Establishment of one cavern, 100 million Nm3 (approx. 1.1 TWh)

	Mill. €
Construction and equipment	22
Cushion gas for one cavern (40% of total)	14
Total cost, 100 mio Nm3 active volume	36

Process equipment; injection 200,000 Nm3/hour (approx. 2200 MW), withdrawal 600,000 nM3/hour (approx. 6600 MW)

	Mill. €
Construction work	2.8
Compressors, incl. auxiliaries	30
Udtrækstog	13
Withdrawal equipment	4.5
Connections, transformer, regulation, and instruments	13
Total investment cost	63

A new greenfield store, equivalent to Lille Torup in Denmark, would require one leaching plant, 5 caverns, and one process plant.

Total investment cost 254 mill. €

Operation and maintenance, salt cavern, 400-500 million m3 working gas

	Mill. € per year
Electricity	0.7 - 1.1
Gas consumption to reheat extracted gas	0.13
Total, incl. administration	6.5

151 HYDROGEN STORAGE

This chapter has been moved from the previous Technology Data Catalogue for Electricity and district heating production from May 2012. Therefore, the text and data sheets do not follow the same guidelines as the remainder of the catalogue.

Brief technology description

Hydrogen serves as a storage and transportation medium for energy. In general there are five different ways of storing hydrogen [1]:

- storage of pressurised gas
 - in caverns
 - in tanks e.g. for mobile applications up to 700 bar
 - in pipelines between producers and consumers (like natural gas)
- storage of liquid hydrogen
 - liquefied at -253°C , stored in cryo-tanks
- storage via absorption
 - Metal hydride storage used in submarines commercially today, heavy
- storage in chemical compounds, including SNG, ammonia and synthetic liquid hydrocarbons (DME, Methanol)
- storage via adsorption
 - Adsorption at low temperatures on high surface area carbon and similar compounds, under development.

Input

Hydrogen

Output

Hydrogen

The lower heating value of hydrogen is 10.79 MJ/Nm^3 (0°C and 1.015 bar) or 3.00 kWh/Nm^3 , while the higher heating value is 12.75 MJ/Nm^3 . The density is 0.0899 kg/Nm^3 .

Typical plant capacities

Hydrogen storages can differ greatly in sizes from caverns of 100-100.000 GJ down to pressurised tanks of 300 bar with capacities of 0.4-2.5 GJ [1]⁵.

⁵ General Motors and QUANTUM Fuel System Systems Technology Worldwide has furthermore developed and tested a 700 bar hydrogen storage system which extends the range of a fuel cell vehicle by 60-70 percent compared to an equivalent-sized 350 bar system. (4)

Regulation ability

Production and storage of hydrogen is a tool to enhance regulation ability of the overall energy system, without having to convert the electricity into low value energy like heat. How fast the hydrogen can be converted into electricity and heat depends on the type and number of hydrogen converting fuel cells.

Environmental aspects

Hydrogen is, like electricity, an energy carrier, which is only as clean as the energy source from which it is produced.

Some emissions of hydrogen will take place during storage, distribution and utilisation of the hydrogen. Hydrogen emits to the stratosphere, where it connects with oxygen to form water. An increased amount of water in the stratosphere will lead to further destruction of the ozone layer. It is however calculated that the increase in water in the stratosphere due to hydrogen will be significantly less than the increases, which are expected already to have appeared in the stratosphere during the last 50 years. Therefore, it is uncertain whether future emissions of hydrogen may lead to further damages on the ozone layer [2+3].

Research and development

Most research in hydrogen storage is directed towards storage in tanks for mobile applications, where the challenge is to store hydrogen in tanks under high pressure or liquefied with low weight while ensuring safety and energy amounts for ranges comparable to cars run on fossil fuels today.

Examples of best available technology

When it is necessary to store large amounts of hydrogen in a future energy economy then hydrogen can be pumped into subterranean cavern storages. The method is already in use in UK (Tees Valley), France and the USA (ConocoPhillips Clemens Terminal built a 2500 tonnes cavern store in Texas in the 1980'es, while Praxair established a hydrogen cavern store, also in Texas, more recently). Caverns used for storage of natural gas could be used for the storage of hydrogen in the future.

References

- 1) http://www.hynet.info/hydrogen_e/index00.html
- 2) http://www.dmi.dk/dmi/brint_fra_brandsejlseller_kan_maske_skade_ozonlaget
- 3) <http://www.sciencemag.org/cgi/content/full/300/5626/1740>

Data sheet

Technology	Hydrogen storage, cavern					
	2015	2020	2030	2050	Note	Ref
Energy/technical data						
Output capacity, MW	2					1
Storage volume, MWh	10					1
Overall cycle efficiency, AC-AC (%)	35				A	1
Technical lifetime (year)	30					1
Financial data						
Investment storage, € per kWh storage volume	11				A+B+C	1
Investment converter, € per kW output capacity	3000				A+B+C	1
Fixed O&M (€/MW/year)						
Variable O&M (€/MWh)						

References:

- 1 "Economical and technical evaluation of energy storage systems", presentation by J. Oberschmidt & M. Klobasa, Fraunhofer Institut, at the "Third International Renewable Energy Storage Conference (IRES 2008)", Berlin, November 2008

Notes:

- A System: PEM electrolysis, storage of hydrogen at 30 bar, and a gas engine to convert back to AC.
 B The two investment components shall be added, cf. paragraph 1.3 in the introductory chapter.
 C Cost data are the same as in the 2010 catalogue, however inflated from price level 2008 to 2011 by multiplying with a general inflation factor 1.053

160 PUMPED HYDRO STORAGE

This chapter has been moved from the previous Technology Data Catalogue for Electricity and district heating production from May 2012. Therefore, the text and data sheets do not follow the same guidelines as the remainder of the catalogue.

Brief technology description

For bulk electricity storage in utility grids, pumped hydro power plants dominate, with approximately 100 GW in service around the globe [2].

A typical pumped hydro store (PHS) consists of two water reservoirs (lakes), tunnels that convey water from one reservoir to another, a reversible pump-turbine, a motor-generator, transformers, and transmission connection. The amount of stored electricity is proportional to the product of the volume of water and the height between the reservoirs. As an example, storing 1,000 MWh requires an elevation change of 300 m and a water volume of about 1.4 million m³.

A new PHS, including dams, has high capital expenditures and a long construction time. If an existing hydro plant is extended to also be a PHS, the investment per installed MW is significantly lower and the construction time between 2 and 3 years.

With this technology electricity is basically stored as potential energy. Others ways of storing electricity as potential energy may have similar characteristics.

Input

Electricity

Output

Electricity

Typical capacities

PHS facilities are dependent on local geography and currently have capacities up to 1,000 MW. In addition to large variations in capacities PHS is also very divers regarding characteristics such as the discharge time, which is ranging from several hours to a few days. Efficiency typically is in the range of 70 % to 80 %, due to the losses in the process of pumping water up into the reservoirs.

Regulation ability

The primary intent of PHS is to provide peaking energy each day. However, their duty can be expanded to include ancillary service functions, such as frequency regulation in the generation mode. A variable-speed system design allows providing ancillary service capability in the pumping mode as well, which increases overall plant efficiency [2].

Advantages/disadvantages

The advantage of PHS is the large volumes compared to other storages e.g. various batteries. In addition PHS does not use fossil fuel such as e.g. CAES.

A disadvantage with PHS is the need for differences in height between the two reservoirs. When a new PHS is not built in connection with an existing hydropower plant there are also environmental concerns in flooding large areas.

Research and development

In the 1890's PHS was first used in Italy and Switzerland. After over 100 years of development PHS is considered to be a mature technology. New developments include seawater pumped hydro storage that was built in Japan in 1999 (Yanbaru, 30 MW). It is also technically possible to have a pumped underground storage by using flooded mine shafts or other cavities.

A new (2009) Danish concept is storing electricity as potential energy by elevating sand. The sand is lifted by pumping water into a balloon underneath the sand, and then lowered by taking the water out through the pump, now acting as a turbine.

Additional remarks

There are frequently several hydro power plants on the same river, and the operation of these plants is to some degree interlinked. The benefits of a new PHS therefore depend also on the existing hydropower infrastructure.

For new large hydropower plants in OECD countries, capital costs are about 2400 USD/kW and generating costs around 0.03-0.04 USD/kWh. The cost of pumped storage systems depends on their configuration and use. They may be up to twice as expensive as an equivalent unpumped hydropower system. Depending on cycling rates, their generating costs may be similar to those of unpumped systems [1].

References

- [1] "Energy technology perspectives 2008", International Energy Agency, 2008.
- [2] "Capturing Power Grid", IEEE Power & Energy Magazine, July/August 2009, <http://www.electricitystorage.org/images/uploads/docs/captureGrid.pdf>

Data sheet

Technology	Pumped hydro storage					
	2015	2020	2030	2050	Note	Ref
Energy/technical data						
Generating capacity for one unit (MW)	10-1000	10-1000	10-1000	10-1000	A	2
Total efficiency (%) net	70 - 80	70 - 80	70 - 80	70 - 80	A	1
Technical lifetime (years)	50	50	50	50	A	1
Construction time (years)	2-3	2-3	2-3	2-3	A	
Financial data						
Investment, pump part (M€/MW)	0.6	0.6	0.6	0.6	B;C;A	1&2
Investment, total, greenfield plant (M€/MW)	< 4	< 4	< 4	< 4	D;A	4
Fixed O&M (€/MW/year) - 1-2% of investment	6-12,000	6-12,000	6-12,000	6-12,000	B;A	3
Variable O&M (€/MWh)	Depends on power price					

References:

- 1 BKK, presentation on Nygard Pumpekraftverk
- 2 Tonstad Pumpekraftverk, Sira-Kvina kraftselskap, 2002
- 3 BKK and Sira-Kvina
- 4 "Energy technology perspectives 2008", International Energy Agency, 2008.

Notes:

- A No significant technology advance or cost decrease is expected, since hydropower and water pumping are established technologies.
- B Based on the September 2004 exchange rate of 1NOK = 0,12€
- C Cost data are the same as in the 2005 catalogue, however inflated from price level 2002 to 2011 by multiplying with a general inflation factor 1.2306
- D Cf. paragraph 'Additional remarks' above.

161 COMPRESSED AIR ENERGY STORAGE

Contact information

Danish Energy Agency: Thomas Mandal Østergaard , tmo@ens.dk

Energinet.dk: Rune Duban Grandal, rdg@energinet.dk

Author: Allan Schrøder Pedersen, DTU, Department of Energy Conversion and Storage

Publication date

November 2018

Amendments after publication date

Date	Ref.	Description
December 2018		Formatting and internal references fixed

Brief Technology Description

Compression/expansion

Compressed Air Energy Storage (CAES) is a way of storing electrical energy mechanically and thus the input is electricity to drive a compression. In the most basic form of CAES electrical energy is used to compress air, which can subsequently be stored in pressure tanks or in huge amounts in underground formations, where such suitable formations are available. When release of the stored energy is required, the compressed air is used to drive a turbine able to generate electricity. The expansion of air is associated with a temperature drop.

When air is compressed, heat is released and constitutes a loss of energy during the storage operation because it dissipates to the external environment. However, if the heat may be stored intermediately (e.g. sensibly in ceramic material), the heat may be reinjected during the expansion process and thus it is not lost. This has an impact on the overall efficiency (electricity to electricity). This form of CAES is usually called Adiabatic CAES, A-CAES (or sometimes Advanced Adiabatic CAES, AA-CAES) because of the lack of exchange of heat between the storage system and the external environment. Additional forms of CAES have been proposed, such as isothermal CAES. For these additional forms of CAES there are currently no commercial installations and we will only consider CAES and AA-CAES here.

Presently CAES technology is used in combination with gas turbine combustion, which can be said to compensate for the temperature drop. Therefore CO₂ is released in traditional CAES.

Although the concept of CAES has been considered favorable for energy storage for many years for storing variable, renewable energy only two plants have been realized until now, the first in Huntorf, Germany, in 1978 and the second in McIntosh, Alabama, USA, in 1991. Interestingly, the Huntorf storage facility was constructed to balance nuclear power so that the nuclear generation could be run in an optimal way and the CAES facility could handle the differences between production and demand for electricity. None of the realized facilities are based on A-CAES, but only on CAES,

meaning that the round trip efficiencies are relatively low. Both plants have been operated with use of natural gas turbines to compensate for the lost heat (cf above).

Several excellent and more exhaustive technical descriptions of Compressed Air Energy Storage (CAES) and Adiabatic Compressed Air Energy Storage (A-CAES) are available in literature. Figure illustrates a plant diagram of two different CAES plants – see also further references in the “References” section.

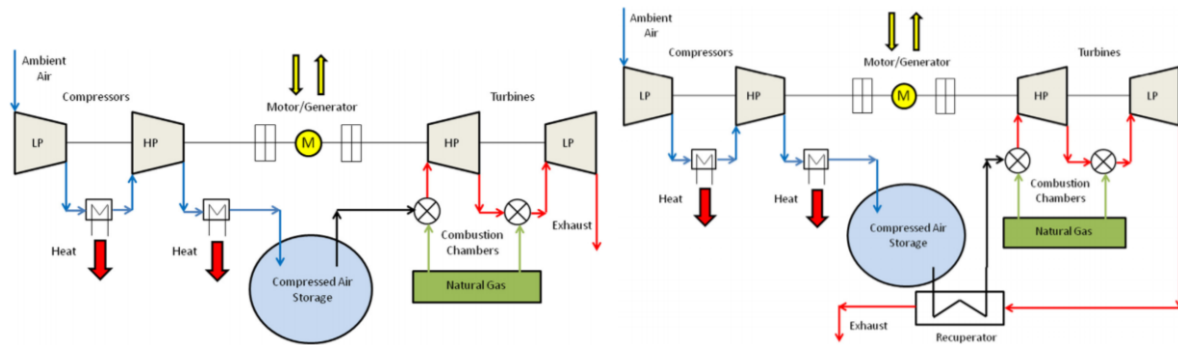

Figure 1: Operating principle of the CAES plant Huntorf (left) and the McIntosh (right) [1]

Table gives key data for the same two plants. The Huntorf plant uses 0.8 kWh of electricity and 1.6 kWh of gas to produce 1 kWh of electricity and was the world’s first CAES plant when it was commissioned in 1978 [2]. The newer McIntosh plant includes a recuperator which recycles waste heat from the exhaust stream and uses 0.69 kWh of electricity and 1.17 kWh of gas to produce 1kWh of electricity [2].

Type	Simple CAES process, two-stage NG combustors	2 nd generation CAES, recuperator, two-stage NG combustors
Location	Huntorf, Niedersachsen	McIntosh, Alabama
Commissioning	1978	1991
Turbine power	320 MW _{el}	110 MW _{el}
Generation capacity	~1 GWh	2.6 GWh
Thermal round trip efficiency	~42 %	~52 %
Specific cost	320 DM/kW _{el}	\$591/kW _{el}
Turbine start-up time	>9 min.	14 min.

Table 1: Data for the Huntorf and the McIntosh traditional CAES plants [3].

For A-CAES (a technology, which has not yet been realized) storage of heat has been proposed in ceramic materials like rocks or bricks at elevated temperatures (say 600 °C).

It is questionable how many traditional CAES plants will actually be built in the future. Many optimistic studies have been performed - particularly in the US - during the past 25 years, however it remains a fact that none have been built. In Denmark the preparation of new salt caverns is associated with environmental problems, as heavy metals are dissolved together with the salt as the cavern is solution-mined.

Air storage volumes

CAES depends completely on a connection to suitable storage volumes. Small units may utilize high pressure gas cylinders (surface level), but to allow for large amounts of energy (hundreds of MWh) CAES is usually planned and established in connection with large underground formations able to hold significant amounts of compressed air. Such formations could be depleted oil or gas fields, aquifers, salt caverns, lined rock caverns and abandoned mines [4]. An illustration of some of the storage principles is shown in Figure 2.

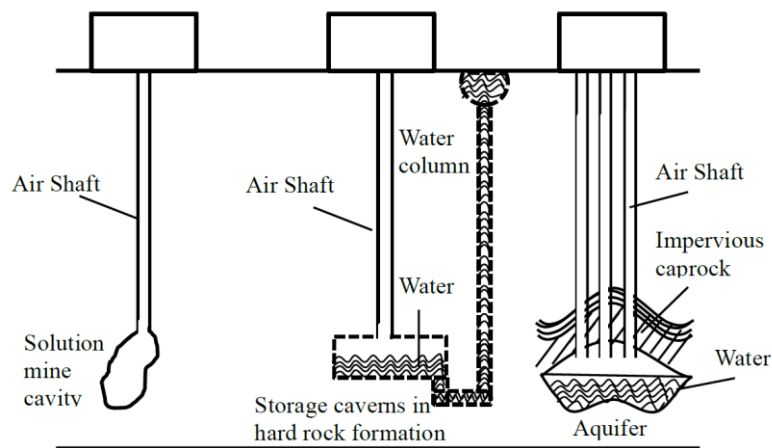

Figure 2: Various Geological Formations for Underground Storage [5]

The two existing CAES plants are connected to solution-mined caverns in salt domes. Such caverns are relatively cheaply and easily developed and suitable salt deposits are found in many places all over the world. However, the preparation of caverns may be restricted due to potential environmental issues and political opposition. Figure 3 shows the coincidence of large wind power potentials and salt deposits suitable for cavern excavation.

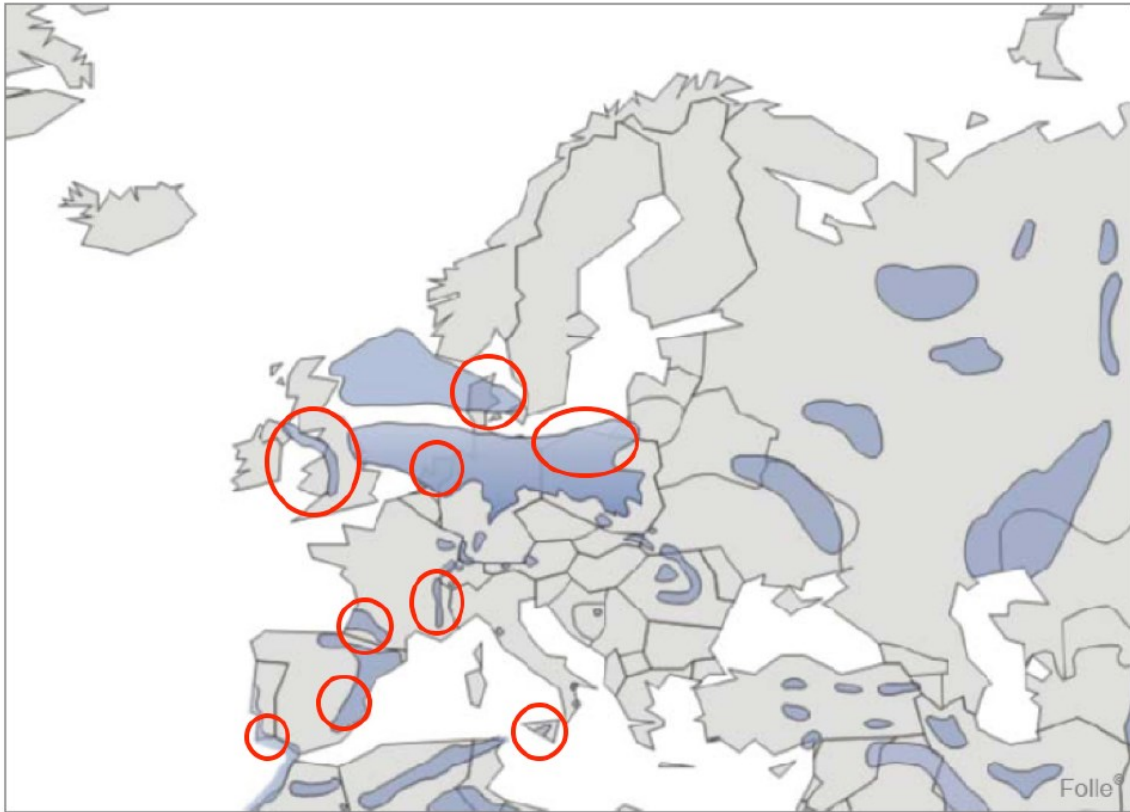

Figure 3: Coincidence of high wind potential (red circles) and salt domes in Europe (blue areas) [6]

Input/output

The input for CAES is electricity. For traditional CAES input of some fuel (usually natural gas) is required in the electricity output phase. For Adiabatic Compressed Air Energy Storage fuel is not required (see below).

The output for CAES is electricity. Traditional CAES also generates heat in the compression phase, whereas ACAES stores this heat and thus does not generate heat to the external environment.

Energy efficiency and losses

Figure 4 illustrates details of the energy lost by using CAES in the compression stage and in the expansion stage. The numbers which can be derived are a charging efficiency of about 80 % and a discharge efficiency of about 70 % leading to a round cycle efficiency of approx. 55 % (electricity to electricity). However, input of chemical fuel in this calculation complicates the calculation since the electricity that could have been produced from the fuel should be subtracted. Setting the electrical efficiency of chemical fuel to 35 % (see note A in Quantitative description) the output efficiency in Figure 4 would be 44 % leading to a round cycle efficiency of 44 %.

Energy transfer of CAES plants:

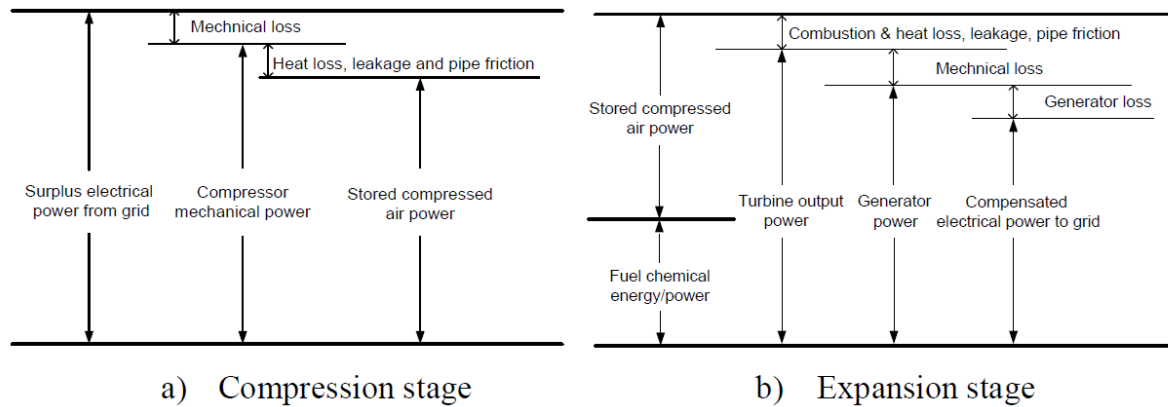

Figure 4: Energy transfer of a conventional CAES plant [7]. The source does not quote numbers but only graphics.

Regulation ability and other system services

Startup times of about 10 minutes are described in the literature for CAES [8]. This allows several ancillary services and thus both black starts, secondary reserves and reactive power system services are possible. Furthermore the technology is perfectly suited for load shifting (the original purpose of the Huntorf plant) within the limits of available storage and power capacity.

Typical characteristics and capacities

As mentioned above only two CAES plants have been realized until now and consequently it does not really make sense to state typical performance characteristics and capacities. The characteristics of the two existing plants can be seen in Table 2.



	Huntorf (1978) Germany	McIntosh (1991) USA
		
Turbine Power / Discharge time	Old 290 MW / 2 hrs New 320 MW / ~3 hrs	110 MW / 24 hrs
Compression Power / Charging time	60 MW / 8 hrs	50 MW / 38 hrs
Power ratio	0.19	0.45
Charge / Discharge time Ratio	2.7	1.6
Cavern Pressure	46 – 72 bara	45 – 74 bara
Efficiency	42%	54%
Heat Rate	6700 BTU/kWh (without heat Recuperator)	4100 BTU/kWh (with heat recuperator)
Availability	➤ 90 %	➤ 90 %
Reliability	➤ 97 %	➤ 97 %
Start-up reliability	➤ 95 %	➤ 95 %
Cavern	2 x 150'000 m ³ (Salt Cavern)	538'000 m ³ (Salt Cavern)

Table 2: Supplementary descriptive data for the Huntorf and McIntosh facilities. The indicated heat rates (thermal energy in over electrical energy out) can be recalculated to 1.96 kWh/kWh for Huntorf and 1.20 kWh/kWh for McIntosh [9].

As can be seen the CAES plants have been built for up to 50-60 MW charging power and 100-300 MW discharging power.

Based on the numbers shown in the above table the energy storage capacities of the plants are 480 MWh for Huntorf and 1,900 MWh for McIntosh.

The energy density of compressed air naturally depends on the pressure difference between upper and lower limit of the pressure variation. For the Huntorf facility the energy density is approximately 0.3 kWh/m³. For the McIntosh the number is about the same since the same pressure range is used. However, the energy densities (kWh/m³ and kWh/kg) associated with CAES is not considered relevant, one reason being that the technology is stationary.

It is interesting to note that both plants are utilizing salt domes as storage facility for the compressed air. Other proposed storage facilities are abandoned mines and aquifers, but these types have not yet been realized.

Figure 2 in the Electricity Storage chapter shows a comparison between CAES and several other energy storage technologies concerning discharge time and power rating. Clearly CAES is a bulk storage technology in class with pumped hydro and power to gas (not shown).

Typical storage period

The practical span of storage periods for CAES can be estimated from Figure 5 showing the number of starts per year for the Huntorf plant in the period from 1978 to 2000. In course numbers the numbers of starts vary in the range 50-200 with outliers up to 400 and down to about 25. This shows that practical storage periods range between hours and days. However, these storage periods reflect the facility's actual use pattern rather than the capability. Since air is stored in underground caverns in salt domes, which are very tight (cf. use of salt caverns for natural gas) the air can be stored for much longer time if so desired. The levelized cost of energy storage will increase if longer time periods are applied, but it can easily be done.

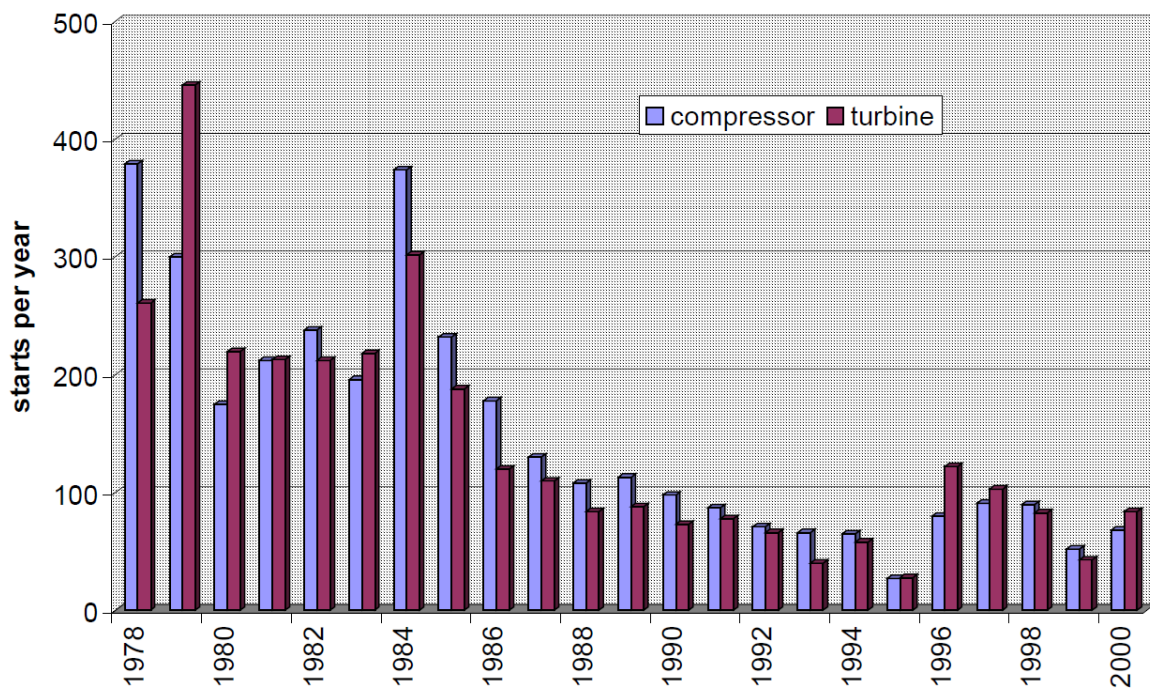

Figure 5: Number of compressor starts (charges) and turbine starts (discharges) for the Huntorf facility for the period between 1978 and 2000 [10]

Space requirement

The space requirement for a CAES facility can be seen from the following photo [11], which shows the Huntorf CAES plant from above. Thus an area of approx. 200x200 m (40,000 m²) is required for 320 MW_{el} output. However, according to reference [8] 1 acre, which corresponds to approximately 4000 m² (63x63 m), is required for a 100 MW output plant.



Figure 6: Aerial photo of the Huntorf facility [12] .

The placing of a CAES plant depends completely on accessibility to store large amounts of compressed air. Since the energy storage capacity depends on the volume of underground formations it is not possible to give a number in m^3/MWh . As mentioned the existing two plants utilize underground caverns in salt domes. Other structures may be used but the entrepreneur is not free to establish a CAES plant wherever needed and thus the 200 by 200 m^2 surface area (for 320 MW) mentioned above does not set the complete requirements.

Advantages/disadvantages

Advantages

The following advantages are cited from [8] :

- The CAES plant can provide significant energy storage (in the thousands of MWhs) at relatively low costs (approximately (in 2003 USD) $\$400/\text{kW}_{\text{ac}}$ to $\$500/\text{kW}_{\text{ac}}$). The plant has practically unlimited flexibility for providing significant load management at the utility or regional levels.
- Expanders have a large size range. Commercial turboexpander units range in size from 10 -20 MW_{ac} (Rolls Royce-Allison) to 135 MW_{ac} (Dresser-Rand) to 300-400 MW_{ac} (Alstom).
- The CAES technology can be easily optimized for specific site conditions and economics.
- CAES plants are capable of black start. Both the Huntorf and McIntosh plants have black start capability that is occasionally required.
- CAES plants have fast startup time. If a CAES plant is operated as a hot spinning reserve, it can reach the maximum capacity within a few minutes. The emergency startup times from cold conditions at the Huntorf and McIntosh plants are about 5 minutes. Their normal startup times are about 10 to 12 minutes.
- CAES plants have a ramp rate of about 30 % of maximum load per minute.
- A CAES plant can (and does) operate as a synchronous condenser when both clutches are opened (disconnecting the motor-generator from both the compressor train and the expander

train), and the motor-generator is synchronized to the grid. Reactive power can be injected and withdrawn from the grid by modulating the exciter voltages. Both the Huntorf and the McIntosh plant are used in this manner. Since this operation does not require the use of stored air, the plant operator can choose to operate the plant in this mode for as long as necessary.

- Danish installations could benefit from the widespread and developed district heating infrastructure. CAES installations can sell the heat generated in the gas compression phase and purchase the heat in the decompression phase, thus reducing the need for natural gas.

Disadvantages

- For traditional CAES the use of natural gas implies CO₂ emissions. However, for A-CAES there is no use of chemicals and no exhausts.
- Geographical placement is limited to places, where high pressure air can be stored in sufficient amount. Several geological underground formations are suitable, but the restriction puts limitations to where CAES can be placed.
- In the basic form (without intermediate heat storage) CAES shows a relatively low electricity to electricity efficiency around 45 % without recuperation.

Environment

The main environmental impacts from operating a CAES plant - except from surface footprint – relate to the use of fossil energy in the expansion phase [13]. This problem could be overcome by the development of A-CAES (Adiabatic CAES), where heat is stored from the compression phase and redelivered in the expansion phase.

However, in the construction phase it has been found that the environmental impacts correlate strongly with the size and method of construction of the underground storage cavity [14]. Particularly for solution mined salt caverns the dissolved salt may (depending on location) contain concentrations of heavy metals, which may not readily be disposed in rivers or lakes or even in the sea.

Research and Development Perspectives

Research and development efforts for CAES are directed towards improving the relatively low round cycle efficiency by intermediately storing the heat generated in the compression phase and reuse it during the expansion phase (ACAES) [15]. Figure 7 shows how the German utility company RWE envisages how a heat storage facility can be incorporated in a CAES plant. Heat may be stored at temperatures up to 600 °C or even higher in rock (stone) or other ceramic materials and the technology is being developed for a variety of purposes these years. Within a time perspective of 10-15 years it thus seems fair to anticipate that A-CAES will be commercially available. This development is expected to improve the power-to-power efficiency to around 70 % and bring A-CAES into a much more attractive efficiency class



Figure 7: RWE's vision for an ACAES plant [15].

Examples of market standard technologies

There is not a living market for CAES plants. As mentioned, only two plants have been built worldwide until now – in 1978 and 1991. It does not seem fair to take any of these as standard technologies. If the demand for CAES will increase at some point in the future it must be expected that CAES market standards will be developed based on up-to-date technologies for compressors, turbines and thermal energy storage (A-CAES).

Prediction of performance and costs

Efficiency until 2016

Recorded performance – in terms of electricity to electricity efficiency – for the Huntorf and McIntosh plants are 42 % and 54 % respectively [16]. The main reason for the difference is that the McIntosh plant utilizes recuperation of waste heat from the expansion turbine. Conventional CAES uses additional fuel in the discharge phase and thus has a not ignorable CO₂ emission.

In the Datasheet it is assumed, that a CAES plant built today will have the same efficiency as the McIntosh plant or maybe higher.

Efficiency 2020 - 2050

It must be expected that future CAES plants 10-15 years from now will be based on adiabatic CAES, which has a much better efficiency, estimated to be around 70 %. We are therefore likely to see a stepwise increase in efficiency of CAES at some point in the future, when appropriate thermal energy storage technology has been developed. Considering present activities within high-temperature energy storage technologies this point is estimated to be about 2030.

Cost

A-CAES comes at an increased cost, because of the addition of the thermal energy storage. For an indication of the price difference see Table 4.

It is questionable how many traditional CAES plants will actually be built in the future. Many optimistic studies have been performed - particularly in the US - during the past 25 years, however it remains a fact that none have been built. Since 2013 the Irish utility company Gaelectric has been working to establish a traditional CAES plant in Larne, Northern Ireland [17]. The company reports that plans are underway to establish CAES plants in the United Kingdom and in the Netherlands. Gaelectric states the total investment cost to be £300 million in the Larne CAES project, according to independent analysis by PMCA Economic Consulting [18]. The facility will generate up to 330 MW of power for periods of up to 6 hours. It will create demand of up to 200 MW during the compression cycle [18].

Documented prices for CAES plants are few and old. The individual technologies involved in a CAES plant (i.e. compressors, solution mining and turbines) existed before they were put together in a CAES plant. On the other hand the same technologies (or close to the same) have been further developed concerning performance and costs and the same (matured) development must be expected to continue for many years ahead showing a price decreases of 0.5-1%/year characteristic for such technologies. It should be noted here, though, that one source [19] quotes a report, which the author of this section has not been able to retrieve, in the following way:

A 2005 report on the economic impact of CAES suggests the following reasons:

1. Since regulated utilities grew through an increase in invested capital, there was no economic incentive to add CAES, which increases the efficiency of existing plants and decreases the total capital required to serve a given load;
2. Independent power producers in the US did not develop CAES because CAES did not qualify for Public Utility Regulatory Policies Act (PURPA) contracts, which were available only for renewable power plants or for cogeneration facilities.
3. There was a boom in power plant construction in the late 1990's, but a lack of available equipment prevented the development of new CAES plants. Until very recently, major turbine manufacturers had sold out production capacity and had not been willing to invest in the development of CAES turbines.

As mentioned above several researchers have estimated prices for CAES plants over recent years. It is likely that not all sources quoting such prices have actually developed prices themselves independently. Quite some redundancy is seen in estimated prices and looking into the literature you find that many authors actually rely on Electric Power Research Institute [8], [20].

Table 3 gives 2015 inflation-corrected prices for CAES plants in terms of EUR/kW and EUR/kWh [21]. The cost per kW varies from 300 EUR/kW to 1250 EUR/kW and costs per kWh prices vary between 0.09 EUR/ kWh and 120 EUR/ kWh.

For use in the data sheet the costs per kWh between 0 and 2 EUR/kWh have been disregarded because it is assumed, that only storage costs are included here (that is costs for mining the storage cavities).

Year of publication	Investments cost per discharge capacity		Investments cost per energy storage capacity		Reference no.
	\$/kW*	€/kW (2015 prices)	\$/kWh*	€/kWh (2015 prices)	
2003	450	460	1.0	1.0	12
2007	850	680			23
2007	890	710			24
2008	650	530	1.75	1.40	6
2009	750	580			25
2009	540	420	130	100	26
2010low	430	340	2	1.6	27
2010high	480	380			27
2011	1000	820	150	120	20
2011	900	740			22
2012low	400	320	2	1.6	8
2012high	1150	910	120	100	8
2012	400	320			28
2012			0.12	0.09	29
2013low	400	300	120	90	9
2013high	1000	740			9
2014low	500	420			16
2014high	1500	1250			16
2014	1400	1170			2
2015low**	300	410	0.6	0.8	30
2015high**	500	690	18	25	30
2016	1300	1220			31
2017***	750	660			18

Table 3: Prices for CAES plants from literature. Year, references and prices in source currency are given. The cost is converted into 2015 prices. *in reference year prices, **reference in £, ***reference in €.

Table 4 below gives yet another cost breakdown for CAES and A-CAES plants illustrating the cost differences between the two types. The total cost for A-CAES is seen to be 43 % higher than for conventional CAES. Comparing the table with Figure 3 above also gives an impression of the divergence (or uncertainty) of the prices (compare e.g. salt cavern cost fraction).

	Conventional CAES ²		Adiabatic CAES ³	
	Cost (\$2009/kW)	Cost Fraction (%)	Cost (\$2009/kW)	Cost Fraction (%)
Compressor	84	11	129	13
Heat Exchanger	33	4	150	15
High pressure expander	60	8	114	11
Low pressure expander	140	19	100	10
Electrical and Controls	44	6	60	6
Cavern Development	75	10	86	8
Construction materials and labor	215	29	255	25
Indirect Costs	98	13	137	13
Total	749	-	1031	-

Table 4: Cost breakdown for a conventional and adiabatic CAES system deployed with a salt cavern [22]. These costs represent a conventional system with 10 hours of storage and an oversized expander (110 MW) relative to the compressor (81 MW). Capital costs are expressed in terms of expander capacity. These costs represent an adiabatic CAES system with 10 hours of storage and oversized compressor (96 MW) relative to the expander (72 MW). Capital costs are expressed in terms of expander capacity.

Table 5 shows the costs for the energy storage components in \$/kWh. The share of the cost that can be related to the energy storage differs significantly depending on the storage media, from 0.3 % for *porous media* to 46 % for *hard rock (new cavern)*. The solution-mined salt caverns (which are relevant for Danish conditions) can be seen to be cheap in particular in comparison with hard rock solutions, the cost related to the salt mine energy storage makes up 3 % of the total.

Storage medium for CAES plant	Size (MWe)	Cost for power related plant components (\$/kW)	Cost for the energy storage components (\$/kWh)	Typical hours of storage for a plant	Total capital costs (\$/kWe)
Salt	200	350	1	10	360
Porous media	200	350	0.10	10	351
Hard rock (new cavern)	200	350	30	10	650
Surface piping	50	350	30	3	440

Table 5: CAES plant costs for various storage media [23], 2002

Figure 8 gives another cost breakdown for a CAES plant and shows the fraction of costs associated with developing the salt cavern. This fraction is about 40 %. It can be seen that the turbine is another costly component of the system and comprises about 30 % of costs. Comparison with the numbers in Table 4 also gives an indication of the uncertainty of prices stated in different reports and articles.

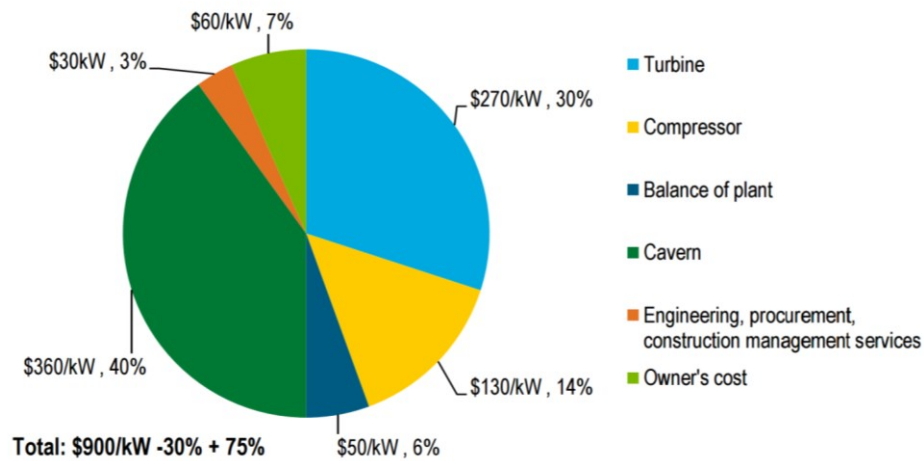

Figure 8: The capital cost breakdown for a CAES plant, approximately 262 MW net with 15 hours of storage and with storage in a solution-mined salt dome is assumed [24], 2012

Table 6 gives a detailed cost breakdown for CAES showing cost classes that are not often shown. The size of the designed plant was 150 MW charging and 83 MW discharging.

Project Title: PROJECT:		Hybrid CAES Yakima Min.		Scenario Name: Low Flow	
Project Name:		North America		Prep. By: --	
Proj. Location:		08JAN13		DOLLARS	
Estimate Date: 18:35:30		Est. Class:		Currency: USD	
Account	MH	Labor Cost	Matl Cost	Total Cost	Percentages
(2) Equipment	31,040	1,552,000	77,141,100	78,693,100	70% of TDC
(3) Piping	74,451	3,722,550	14,477,200	18,199,750	16% of TDC
(4) Civil	70,889	3,544,450	3,163,500	6,707,950	6.0% of TDC
(6) Instruments	7,085	354,250	1,151,400	1,505,650	1.0% of TDC
(7) Electrical	14,270	713,500	4,380,400	5,093,900	5.0% of TDC
(8) Insulation	21,762	1,088,100	796,100	1,884,200	2.0% of TDC
(9) Paint	8,158	407,900	89,700	497,600	<1.0% of TDC
Total Direct Field Costs	227,655	11,382,750	101,199,400	112,809,805	100.0% of TDC
	(TDMH)	(TDL)	(TDM)	(TDC)	
Indirect Field Costs				9,154,156	
				(IFC)	
Total Field Costs	227,655			121,963,961	69% of TIC
	(TFMH)			(TFC)	
Freight				4,047,976	4.0% of TDM
Taxes and Permits				6,324,963	5.6% of TDC
Engineering and HO	38,881			6,590,300	3.7% of TIC
Other Project Costs				10,373,000	5.8% of TIC
Contingency				26,874,100	15.3% of TIC
Total Non-Field Costs	38,881			54,210,339	30.7% of TIC
Project Total Costs				176,174,300	156.0% of TDC

Table 6: Overnight capital costs of hybrid CAES facility [25]

Prediction of performance

The perspectives for significantly improving performance of conventional CAES are not very positive. The technology relies on quite well known technology (i.e. compressors, expanders/turbines and cavern), which can indeed be purchased in a mature state already today.

Table 7 below shows results prepared by Black & Veatch for the National Renewable Energy Laboratory in the USA for a conventional CAES plant [24]. The lack of improved cost (inflation and deflation cleaned prices) and performance characteristics in this study is obvious for the period towards 2050. Data is simply the same in all columns over the period.

An informal communication with Energinet.dk (natural gas storage section) did not suggest any foreseen change in prices for solution mining salt caverns. In addition, solution mining is done quite rarely and thus not much data is available. Costs for solution mining depend strongly on local geographic and underground conditions.

Based on the fact that conventional CAES relies very much on well-known, well-proven and long existing technology components it is not anticipated that the costs for CAES plants will change significant towards 2050.

Year	Heat Rate (Btu/kWh)	Capital Cost (\$/kW)	Variable O&M (\$/MWh)	Fixed O&M (\$/kW-year)	Round-Trip Efficiency	FOR (%)	POR (%)	Construction Schedule (Months)	Min. Load (%)	Spin Ramp Rate (%/min.)	Quick Start Ramp Rate (%/min.)
2008	4910	927	–	–	–	–	–	–	–	–	–
2010	–	–	–	–	–	–	–	–	–	–	–
2015	4910	900	1.55	11.6	1.25	3	4	18	50	10	4
2020	4910	900	1.55	11.6	1.25	3	4	18	50	10	4
2025	4910	900	1.55	11.6	1.25	3	4	18	50	10	4
2030	4910	900	1.55	11.6	1.25	3	4	18	50	10	4
2035	4910	900	1.55	11.6	1.25	3	4	18	50	10	4
2040	4910	900	1.55	11.6	1.25	3	4	18	50	10	4
2045	4910	900	1.55	11.6	1.25	3	4	18	50	10	4
2050	4910	900	1.55	11.6	1.25	3	4	18	50	10	4

Table 7: Cost and performance projection for a 262 MW CAES plant [24]. The source does not explain how efficiency over 1 should be interpreted.

The energy storage cost target set by the European Commission for Thermal Energy Storage in 2030 is 28 €/kWh or 0.028 M€/MWh [26]. This will naturally add to the CAES price in 2030, when A-CAES is expected to gain market share. However, in 2050 this cost add-on is expected to be reduced by 50 % because of a steep learning curve and the effect of mass production by that time.

Quantitative description

Technology	Compressed Air Energy Storage										
	2015	2020	2030	2050	Uncertainty (2020)		Uncertainty (2050)		Note	Ref	
Energy/technical data					Lower	Upper	Lower	Upper			
Form of energy stored	Electricity to mechanical and heat										
Application	System, energy-intensive										
Energy storage capacity for one unit (MWh)	3000	3000	3000	3000	-	-	3000	10000	I	[3]	
Output capacity for one unit (MW)	300	300	300	300	-	-	300	500	I, J	[3]	
Input capacity for one unit (MW)	60	60	60	60	-	-	60	80	I, J	[9]	
Round trip efficiency (%)	55	60	70	72	55	55	64	72	A, B	(Nakhmkin & Patel)	
- Charge efficiency (%)	80	80	84	85	80	80	80	85		[7]	
- Discharge efficiency (%)	69	80	84	85	69	69	80	85		[7]	
Energy losses during storage (%/period)	Close to 0	0	0	0	0	0	0	0		[27]	
Auxiliary electricity consumption (% of output)	-	-	-	-							
Forced outage (%)	5	5	4	4	-	-	2	4	I, K	[9]	
Planned outage (weeks per year)	5	5	4	3	-	-	2	3	I, K	[9]	
Technical lifetime (years)	40	40	40	40	35	45	35	45		[20] [8]	
Construction time (years)	<3	<3	<3	<3	2	3	2	3		[8]	
Regulation ability											
Idle to full discharge (sec)	700	700	1000	1000	500	1000	800	1200	D, G	[3], [8]	
Full charge to full discharge (sec)	-	-	-	-					F		
Financial data											
Specific investment (M€2015 per MWh)	0.65	0.65	1.0	0.8	0.3	1.2	0.4	2.0	C, E	Table 3 [26]	
-Energy component (M€/MWh)	0.002	0.002	0.002	0.002	0.002	0.01	0.002	0.01	H	[23]	
-Capacity component (M€/MW)	0.6	0.6	0.9	0.9	0.3	1.2	0.3	1.2		[24]	
-Other project costs (M€/MWh)	0.085	0.085	0.085	0.085	0.08	0.09	0.08	0.09		[24]	
Fixed O&M (€2016/MW/year)	2460	2460	2460	2460	2000	4000	2000	4000		[20]	
Variable O&M (€2016/MWh)	2.46	2.46	2.46	2.46	2	3	2	3		[20]	
Technology specific data											
Specific investment ((€2016/kW)	640	640	640	640	-	-	550	640	C, K	Table 3	

Notes

- A. For efficiency it is assumed that that new CAES plants can be constructed with at least the same efficiency as the McIntosh plant.
- B. The use of gas in a CAES plant is assumed at the same efficiency as the average use of chemical fuels in the Danish electricity system, i.e. 35% in 2014
- C. In general it is assumed that at some point between 2020 and 2030 adiabatic CAES plants will dominate the market. This means that investment costs will increase and performance characteristics will improve.
- D. The obtainable ramping rate is likely to decrease after application of thermal energy storage. This is because the heat must be delivered to the storage material, which is a process that cannot be controlled independently.
- E. For the costs per kWh in Table 3 the data lying between 0 and 2 EUR/kWh have been disregarded because it is assumed, that only storage costs are included
- F. Operation not suitable nor relevant for CAES. Data not available.
- G. If a CAES plant is operated as a hot spinning reserve, it can reach the maximum capacity within a few minutes. The emergency startup times from cold conditions at the Huntorf and McIntosh plants are about 5 minutes. Their normal startup times are about 10 to 12 minutes [8]
- H. Energy component here taken as the cavern excavating
- I. New plants cannot be realized in 2020 because of lead time. Furthermore the upper limit for storage capacity of one unit is determined by cavern volume, which can be obtained practically without.
- J. Upper limit in 2050 is based on the author's assessment of technological development until then.
- K. Lower limit in 2050 is based on the author's assessment of technological development until then.

References

- [1] S. Karellas and N. Tzouganatos, "Comparison of the performance of compressed-air and hydrogen," vol. 29, 2014.
- [2] E. Barbour, "<http://energystoragesense.com/compressed-air-energy-storage/>," [Online].
- [3] S. Zunft, S. Freund and E. M. Schlichtenmayer, "Large Scale Electricity Storage with Adiabatic CAES," Paris, November 2014.
- [4] "Geological storage in Northern Ireland," Geological Survey of Northern Ireland. [Online].
- [5] P. Johnson, "ASSESSMENT OF COMPRESSED AIR ENERGY STORAGE SYSTEM (CAES)," Thesis Submitted to the University of Tennessee, University of Tennessee at Chattanooga, Chattanooga, Tennessee, USA, 2014.
- [6] R. W. S. Succar, "Compressed Air Energy Storage: Theory, Resources, And Applications For Wind Power," Energy Systems Analysis Group, Princeton Environmental Institute, Princeton University, April 2008.
- [7] J. W. X. Luo, "Overview on current development on Compressed Air Energy Storage, EERA Technical Report – CAES.," School of engineering, University of Warwick. Available on <http://integratedenergystorage.org/>. Accessed February 2017, December 2013.
- [8] I. Gyuk and S. Eckroad, "EPRI-DOE Hanbook of Energy Storage for Transmission and Distribution Applications,1001834, Final Report," EPRI and DOE, December 2003.
- [9] Nakhamkin and Brotel, "Second generation compressed air storage," in Energy Storage Forum Europe, Rome, 2012.
- [10] F. Crotagino, K.-U. Mohmeyer and R. Scharf, "Huntorf CAES / More than 20 years of successful operation," Orlando, April 2001.
- [11] "<https://dddusmma.wordpress.com/2014/05/30/storage-is-essential-for-wind-and-solar/>," Department of Energy, USA. [Online]. [Accessed 2017].
- [12] "<https://dddusmma.wordpress.com/2015/03/17/the-quest-for-storing-electricity/>," 17 March 2015. [Online]. [Accessed 2017].
- [13] A. Wänn, P. Leahy, M. Reidy, S. Doyle, H. Dalton and P. Barr, "Environmental performance of existing energy storage installations. Deliverable D.3.1. Available on www.store-project.eu. Accessed February 2017," stoRE project, 2012.
- [14] E. Bouman, M. M. Øberg and E. G. Hertwich, "LIFE CYCLE ASSESSMENT OF COMPRESSED AIR ENERGY STORAGE (CAES)," Gothenburg, 2013.
- [15] "ADELE – ADIABATIC COMPRESSED-AIR ENERGY STORAGE FOR ELECTRICITY SUPPLY. RWE Brochure.," RWE Power AG, Cologne, 2010.

- [16] "Energy Storage Technology Roadmap, Technology Annex, p. 5," International Energy Agency, March 2014.
- [17] Gaelectric. Accessed February 2017. [Online].
- [18] "Gaelectric energy storage: The missing link. Brochure by Gaelectric. Available on <http://www.gaelectric.ie/energy-storage-publications/>. Accessed February 2017," Gaelectric.
- [19] [Online].
- [20] D.Rastler, A. Akhil and D. Gauntlett, "Energy Storage System Costs 2011 update. Executive summary.," 2011.
- [21] "InflationData.com," InflationData, 2017. [Online]. [Accessed March 2017].
- [22] E. Drury, P. Denholm and R. Sioshansi, "The Value of Compressed Air Energy Storage in Energy and Reserve Markets," National Renewable Energy Laboratory, USA, 2009.
- [23] "Handbook for Energy Storage for Transmission or Distribution Applications. Report No. 1007189. Technical Update December 2002. Document can be found at: www.epri.com," EPRI, 2002.
- [24] "COST AND PERFORMANCE DATA FOR POWER GENERATION TECHNOLOGIES, Report prepared for the National Renewable Energy Laboratory, Available on <https://www.bv.com/docs/reports-studies/nrel-cost-report.pdf> (Accessed February 2017)," Black & Veatch, 2012.
- [25] B. McGrail, "Techno-economic Performance Evaluation of Compressed Air Energy Storage in the Pacific Northwest. Available on <http://caes.pnnl.gov/pdf/PNNL-22235.pdf>. Accessed February 2017," Pacific Northwest National Laboratory (operated by Battelle), 2013.
- [26] "Materials Roadmap Enabling Low Carbon Energy Technologies, Commission Staff Working Paper," European Commission, Brussels, 2011.
- [27] A. Bary, "Storing natural gas underground. Available on https://www.slb.com/~media/Files/resources/oilfield_review/ors02/sum02/p2_17.pdf (Accessed February 2017)," Oilfield review, 2002.
- [28] A. Cavallo, "Controllable and affordable utility-scale electricity from intermittent wind resources and compressed air energy storage (CAES)," vol. 32, pp. 120-127, 2007.
- [29] J. T. Dasand, "Compressed Air Energy Storage (Educational Chapter)," Iowa state University, 2012.
- [30] E. M. G.Locatellia, "Assessing the economics of large Energy Storage Plants with an optimisation methodology," vol. 83, April 2015.
- [31] "Energy Storage News," Energy Storage News, 2016. [Online].

- [32] P. Tayler, "Pathways for Energy Storage in the UK, Report 007," The Centre for Low Carbon Futures, March 2012.
- [33] H. Lund and G. Salgi, "The role of compressed air energy storage (CAES) in future sustainable energy systems," vol. 50, pp. 1172-1179, 2009.
- [34] M. Nakhamkin, M. Chiruvolu and C. Daniel, "Available Compressed Air Energy Storage (CAES) Plant Concepts. Available on http://www.espcinc.com/library/PowerGen_2007_paper.pdf. Accessed February 2017," ESPC and Towngas International Company, 2007.
- [35] J. Simmons, "Study of Compressed Air Energy Storage with Grid and Photovoltaic Energy Generation," The Arizona Research Institute for Solar Energy (AzRISE) - APS Final Draft Report., University of Arizona, 2010.

162 FLYWHEELS

Contact information

Danish Energy Agency: Thomas Mandal Østergaard , tmo@ens.dk

Energinet.dk: Rune Duban Grandal, rdg@energinet.dk

Author: Allan Schrøder Pedersen, DTU, Department of Energy Conversion and Storage

Publication date

December 2018

Amendments after publication date

Date	Ref.	Description

Brief Technology Description

Flywheels store energy mechanically as kinetic energy by bringing a mass into rotation around an axis. According to classical, mechanical physics the kinetic energy of a rotating mass m in distance r from the point of rotation can be expressed as:

$$E_{kin} = \frac{1}{2} \cdot I \cdot \omega^2,$$

where I is the moment of inertia – equal to $m \cdot r^2$ – and ω is the angular velocity (radians per second).

It is seen from this expression that the kinetic energy of a rotating flywheel increases proportionally to the mass and to the distance from the rotation point squared. The energy also increases proportionally to the angular velocity squared.

To maximize the stored energy for a given mass and rotation speed, the mass should be separated from the rotation point as much as possible. On the other hand the centrifugal force acting on the mass is defined as:

$$F_c = m \cdot r \cdot \omega^2$$

and thus the requirements to the materials binding the mass to the rotation center - increases proportionally to the separation distance. This fact sets limits to the maximal available distance because of the properties (tensile strengths) of known, available construction materials.

Whereas flywheels were formerly mainly constructed of metallic materials, modern flywheels are usually constructed – at least partially - by polymer/fiber composite materials. Flywheels are appropriate for fast dynamic energy storage for applications like peak shaving or long energy storage times. Large flywheels should preferably be designed from composite materials due to the high rotational speeds and the bigger strength to weight offered by these materials. Metallic rotors are mainly used for simple seconds to minutes energy

storage systems like UPS (uninterruptable power supplies). Thus, Amber Kinetics believes in steel as a suitable rotor material as seen on the photo to the right in Figure 1.



Figure 1: Photo of WattsUp Power's and Amber Kinetics' flywheels. The latter allowing for a look into the internal steel rotor whereas the first utilizes composite materials for the rotor [1].

Flywheels have been known and used for centuries in steam and combustion engines, whereas development of the independent energy storage potential has only been underway since the 1960s [2]. According to the reference given in [3] the world's largest flywheel has been in operation since 1985. It consists of 6 discs each with a diameter of 6.6 m and thickness 0.4 m, weighing 107 t. The system can supply 160 MW over a 30 sec period and has shown excellent reliability, particular concerning the mechanical construction. Another system developed by Okinawa Electric Company and Toshiba ROTES (ROTary Energy Storage) has been operated since 1996 [4]. The two examples indicate that flywheels represent highly reliable technology. This statement is supported by more recent data from Beacon Power, which states that their system is capable of more than 150,000 charge/discharge cycles at constant full power [5]. Such flywheel systems can be seen in Figure 2, with the addition of a separate fiber composite flywheel being carried by a forklift.



Figure 2: Photo of Beacon Power’s flywheels [6]. The fiber composite flywheel itself is seen to the right on the fork-lift. Each unit is 100 kW. Photo from manufacturer’s store.

A cross section of a flywheel system and the system installed in an operation environment can be seen in Figure 3.

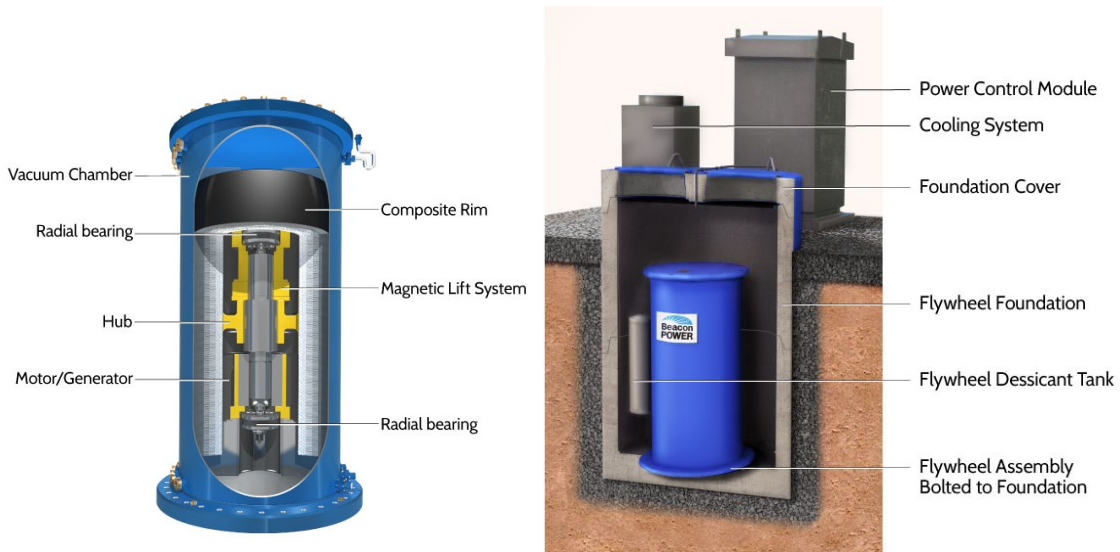

Figure 3: Drawing showing a cross section of the flywheel system and a visualization of how each module of a Beacon flywheel is mounted for operation [6]

Input/Output

The input for flywheels is electricity.

The output from flywheels is electricity.

In principle flywheels can also be charged and discharged mechanically, but in any practical perspective for grid applications electricity would be the input and output.

Energy efficiency and losses

Modern flywheels are operated in high vacuum to eliminate (or strongly reduce) aerodynamic drag. Likewise, the bearings are contact-less magnetic bearings, which means that the mechanical energy losses during a full storage cycle are negligible from a practical perspective. Flywheel technology in itself does not imply any significant energy loss even over prolonged periods. However, the power electronics taking care of converting primary power to the power format suitable for the flywheel and vice versa (the power electronics include rectifier, bus, inverter and converter) gives rise to loss of energy during the use of flywheels. These losses are naturally associated with charging and discharging the wheels and depends somewhat on the mode of operation. In 2018 WattsUp Power stated that stand by losses of today's flywheel technology is about 5% per day whereas round trip efficiency is 98 % for the wheel.

In contrast Beacon Power in 2009 stated that the energy loss would be about 15% for a full charge/discharge cycle, measured at the transformer terminals, whereas for typical operation providing frequency control the loss per cycle would be 6-7% [5].

Due to its mechanical design and working principle, flywheels have zero degradation in energy storage capacity over time. This is independent of how the system is operated and in particular independent of depth of charge and discharge, which is in noteworthy contrast to the properties of most electrochemical battery systems.

Regulation ability and other system services

Flywheels can absorb and release electro-mechanical energy extremely fast. The response time is up to 10 times faster than the response times of batteries, meaning that flywheels can react on demand and supply signals almost instantaneously. This property is attractive for providing ancillary services in the power grid and makes flywheels highly suitable for frequency regulation.

Due to the fast response time flywheels can provide ultrafast ancillary services to the grid, with reaction times down to 3 ms. In particular primary reserves – and even synthetic inertia - for maintaining grid frequency can easily be provided and managed by use of flywheels. The reason for flywheels sometimes outshining batteries for certain applications is their high ramping rate. The fast up and down ramping rates and the not ignorable storage capacity makes flywheels suitable [2] for

- Ramping (how fast an application can increase or decrease load)
- Peak Shaving
- Time Shifting (storing energy from one time to another)
- Frequency regulation
- Power quality (in particular voltage) – Power distribution grids strive to have a power factor as close to 1 as possible. Using flywheels, power utilities may vary active and re-active power to reach a perfect power factor.

An example illustrating the response time of a flywheel system can be seen on Figure 4.

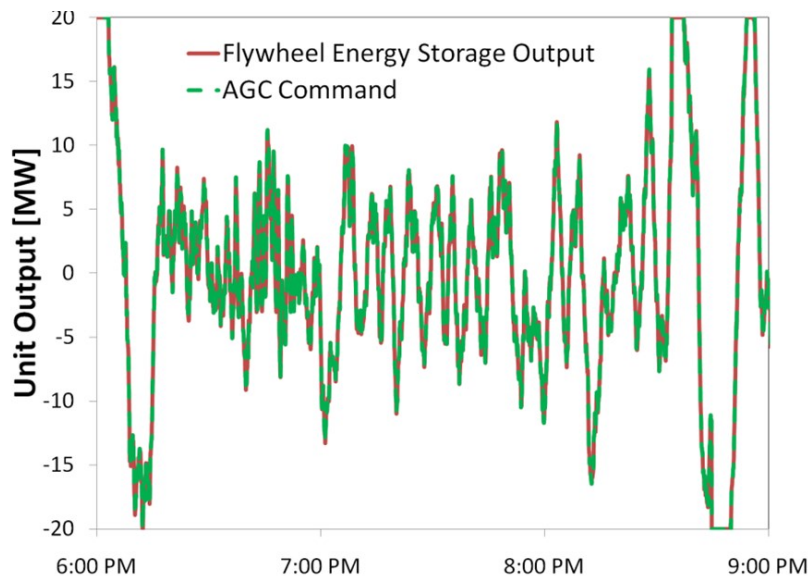

Figure 4: The reaction of a flywheel (MW input/output) in response to signals from the Automatic Generation Control. It can be seen that within the accuracy of the graph (please note the axis scaling) the flywheel follows signals completely. Source: Beacon Power.

Typical characteristics and capacities

Storage density

The energy storage density – whether on volume or weight basis – for flywheels (about 0.05 kWh/kg) is comparable to advanced batteries and in the range of 1-2 orders of magnitude lower than for chemical methods for storing energy (in ways similar to the natural energy storage media oil and gas). This is, however, not important for static applications. On the other hand flywheels have high power densities of about 1 kW/kg [7] also confirmed by WattsUp Power in February 2018.

Sizes of flywheel plants

Flywheels for energy storage can be produced and deployed in numerous sizes ranging from multi MW utility applications to small systems (few kW and kWh) intended for use in cars and buses. Until recently Beacon Power seemed to be the dominating producer of large scale flywheels. Their systems are based on a modular flywheel size (a single flywheel) of 100 kW and 25 kWh, with the standard unit size consisting of an assembly of 10 modules which can be combined in any multiple of 10. Such modules sum up to 1 MW and 250 kWh. Figure 5 shows a photo of an example of their systems that currently provides 20 MW of frequency regulation service.



Figure 5: Photo of Beacon Power flywheel installation in commercial operation in PJM, Hazle, Pennsylvania. The plant includes 200 flywheel modules lowered into the ground (5 on each side of a container). The plant currently provides 20 MW of frequency regulation service to PJM and reached full commercial operation in July 2014 [6].

Typical storage period

Flywheels can be constructed to store energy from seconds to years, but usually the storage period is shorter than days. Flywheels have relatively small standby losses, and the user or producer will design a flywheel for each specific application. Now a typical 10 second storage application could be a UPS (uninterruptable power supply) for hospitals or server centers. In other less typical applications like power peak shaving, the flywheel will be designed to store the power for days and in the most extreme conditions in space applications NASA's flywheel designs store the power for up to 3 years.

Space requirement

The land area requirement for flywheels naturally depends on the capacity of the installation. Figures 5 above gives indications of the area demand, additionally, Beacon Power states that the space required for an installation of 20 MW is 1 acre (approx. 4000 m²)

Advantages/disadvantages

Advantages

Flywheels are fast reacting, reliable, efficient and clean in terms of use of resources and waste disposal.

Some advantages and disadvantages are shown in Table 1.

Advantages and Disadvantages of Flywheel Energy Storage Relative to Other Energy Storage Technologies

Advantages	Disadvantages
Power and energy are nearly independent	Complexity of durable and low loss bearings
Fast power response	Mechanical stress and fatigue limits
Potentially high specific energy	Material limits at around 700M/sec tip speed
High cycle and calendar life	Potentially hazardous failure modes
Relatively high round-trip efficiency	Relatively high parasitic and intrinsic losses
Short recharge time	Short discharge times

Table 1: Advantages and disadvantages of Flywheel Energy Storage Relative to Other Energy Storage Technologies, 2003 [8]. Please note that the table reflects data from 2003, and may have been improved since then. For instance WattsUp is now using tip speed of 875 m/sec.

As an example of hazardous failure modes the crash of two Beacon Power flywheels in 2011 is prominent. The incident was described by the Beacon Power spokesman:

“flywheels failed due to flawed early production runs of the carbon fiber material used in their manufacture. The faulty flywheels spun out of balance and tilted to touch the chamber sides, which caused the flywheels to “grind down” into a heated “cotton candy-like material” of carbon fiber. Safety features in the chamber detected the rising temperature and released water to cool the units, which created steam that caused pressure to increase, blowing off chamber covers in an explosive manner” [9].

Environment

There are no particular environmentally hazardous aspects of flywheels. Materials and production methods imply the same environmental emissions as any manufacturing based on metals and polymers.

Under operation, there is no use of water, harmful chemicals or hazardous materials.

It can be argued that application of flywheels in the grid will save CO₂ emissions to the extent they improve the ability to utilize variable renewable energy production.

Research and Development Perspectives

In 2013 the European Association for Energy Storage (EASE) stated the following R&D needs for flywheels [10]:

1. Flywheel disc: Study of better materials for fibre flywheels (high density) should be carried out in order to reduce the total cost.

2. Electrical machines: High performance machines are required to be used in these devices and although permanent magnet machines seemed to be the best option, the high cost of the magnets has redirected the research to search new machine concepts with less magnets.
3. Bearings: Faster control systems are being developed to improve the bearings response and more efficient actuators are used to increase the performance of the complete system.
4. Power electronics: Increase the added value of the power electronics in an energy storage system, ensuring the robustness and reliability.
5. Digital control and communications: Communication improvements permit to control the system with guaranties of robustness, being able to analyse a lot of variables, maintaining a complete analysis of the application from anywhere, being easily integrated with some other subsystems.
6. Security case or frame: A better knowledge and a more wide experience in prototypes would reduce the cost in security.
7. Demonstration plants to demonstrate the convenience or not of flywheel technology for certain applications

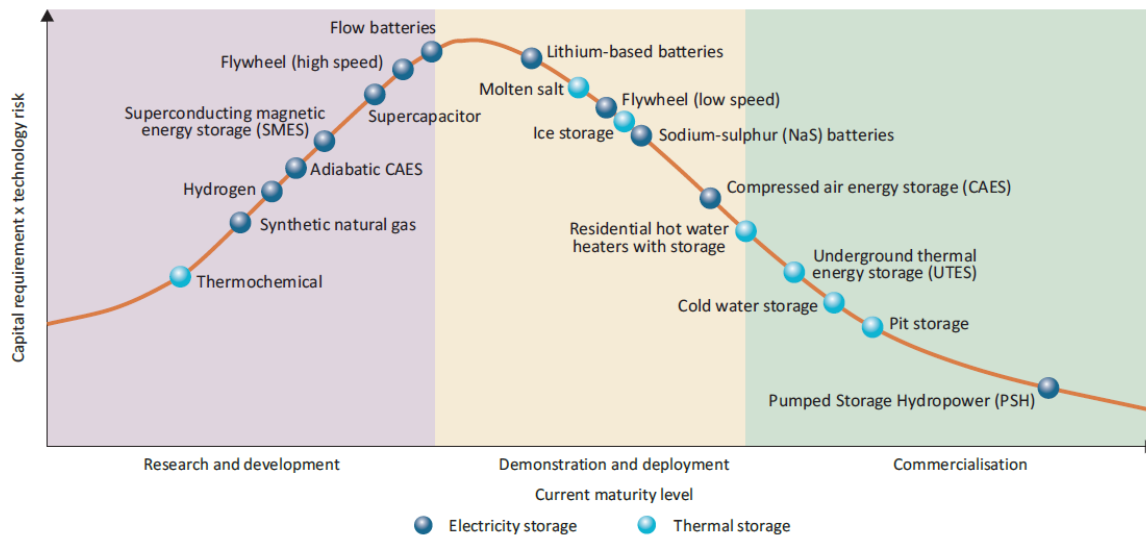

Figure 6: Ranking of energy storage technologies concerning maturity level [11]. Data published in 2013. Flywheels have moved to the next class of the figure since then.

Figure 6 shows how the International Energy Agency (IEA) considers the maturity of flywheels compared to other storage technologies. The ranking was published in 2013 and since then flywheels have gained maturity so that they are now used in commercial applications.

Flywheels are generally considered to be a little less mature technology than many batteries and in addition the cost is perhaps still too high to make them competitive on the commercial market somewhat depending on the specific application, though [12]. However, as described in the present document, flywheels also seem to be catching up rapidly and gain market shares although batteries are still dominating many energy storage

applications. In some applications – like grid stabilization for railways and large battery charging – flywheels are often a preferred solution.

Examples of market standard technologies

Test standards

SAE, the Society of Automotive Engineers, has developed standards [13] for smaller flywheels used in combination with combustion engines. The SAE Recommended Practice applies to flywheels used with internal combustion engines of spark ignition and diesel type. The document is intended to provide a uniform test procedure for flywheel assemblies to determine the rotational speeds at which they will either burst or withstand a specified limiting speed.

According to the IEC, International Electrotechnical Committee, [14] standards have only been developed for mature electrical energy storage systems (such as PHS, LA, NiCd, NiMH and Li-ion) and for those technologies various IEC standards exist. However, to the knowledge of the author of this section no standards exist for grid-connected flywheels.

Potential flywheel suppliers

A number of potential suppliers are listed below. Most manufacturers seem to concentrate their product development towards niche applications like the market for uninterrupted power supply. A simple check of the below web sites shows that some suppliers may not even really market flywheels in the sense that they have standard designs and products. However in relation to ancillary services particularly Beacon Power, Calnetix and recently WattsUp Power have pioneered a considerable development work and seem indeed to be reliable suppliers.

Active Power	www.activepower.com
Amber Kinetics	http://amberkinetics.com
Beacon Power	www.beaconpower.com
WattsUp Power	http://wattsuppower.com/about-us
CAT	http://www.cat.com/en_US/power-systems/electric-power-generation/ups-flywheel.html
Calnetix	https://www.calnetix.com/
Optimal Energy Systems	http://www.optimalenergysystems.com/
Pentadyne	http://www.pentadyne.com/
Piller GmbH	www.piller.com
Precise Power Corporation	http://www.precisepwr.com
Toshiba	http://www.toshiba.co.jp/thermal-hydro/en/hydro/products/facts/rotes.htm
Vycon	www.vyconenergy.com
Urenco Power Technologies	http://www.urengo.com/
Ricardo	http://www.ricardo.com/en-GB/Who-we-are/

Prediction of performance and costs

Performance and costs in 2017

Performance

Figure 7 is an excerpt from test data for a flywheel run in the New York ISO grid in the US. The extremely fast reaction time of flywheels is indicated (often superior to reaction times for batteries). There is no reason to anticipate improvement (or need for improvement) of this performance.

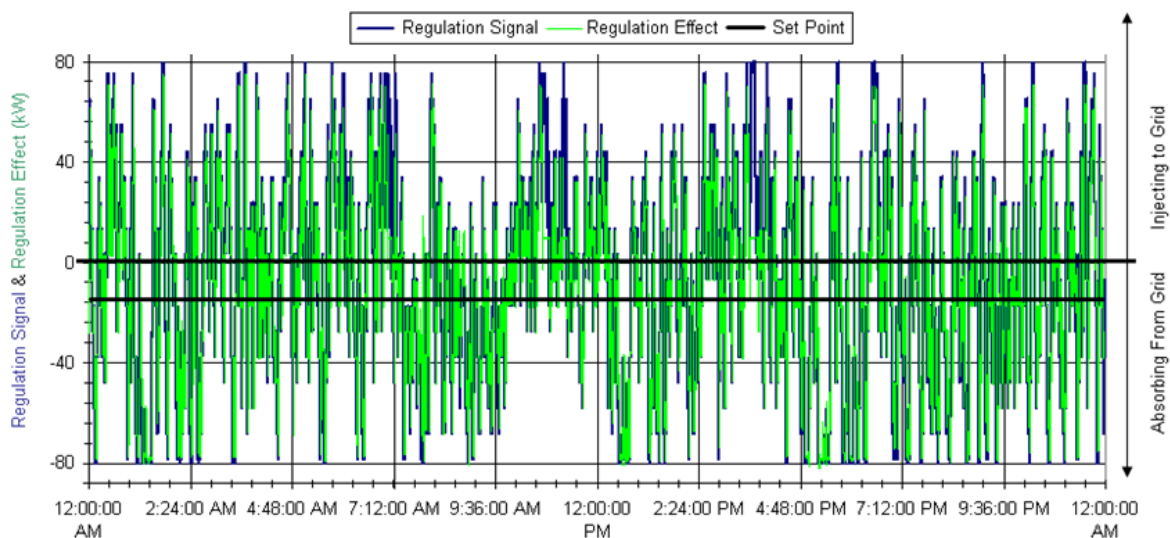

Figure 7: Test data run in the New York ISO grid in the US. The data shows regulation during one day and night after 8 months following fast changing frequency regulation signal. Availability to respond 97.2% of the time it was online. Source: Beacon Power.

Costs

System installation prices naturally depend on the individual location conditions and size of purchase.

Examples of prices for flywheels in 2010 and 2017 and comparison of these prices are shown in Table 2 which is based on information provided by Beacon Power in 2010 and by WattsUp Power (WUP) A/S in 2017 (numbers are based on recent sales).

Cost of flywheel 2010 and 2017			
Beacon Power plants 2010			
Discharge-/charge capacity	(MW)	1	0.2
Energy storage	(Wh/W)	0.25	0.25
Cost per charge capacity	M\$(2010)/ MW	2.9	8
Cost per capacity	M\$(2015)/ MW	3.1	8.5
Cost per charge capacity	M€(2015)/ MW	2.3	6.4
Cost per energy storage	M€(2015)/MWh	9.3	4.6
WattUp plants 2017			
Discharge-/charge capacity	(MW)	1	2
Energy storage	(Wh/W)	0.1	0.1
Cost per charge capacity	M€(2015)/ MW	0.20	0.16
Cost per energy storage	M€(2015)/MWh	2.0	1.6

Flywheel cost reduction 2010 to 2017		
		1
Cost per charge capacity	per MW	92%
Cost per energy storage	per MWh	79%

Table 2: Prices for flywheels and comparison of prices, information is provided by Beacon Power in 2016 and WattsUp Power (WUP) A/S in 2017 (numbers are based on recent sales)

In the examples in Table 2 significant drop in cost from 2010 to 2017 can be seen. The costs calculated per charging/discharging capacity has fallen approximately 90 % (for 1MW plants) and calculated relative to energy storage capacity it has decreased 80 %. This can indicate of that the prices in general have decreased significantly, even if the plants are not directly comparable as the energy storage capacities are not the same.

⁶ Beacon Power 2009:- Full system price for a 1MW(250kWh) system in the range of \$2.8-3 million/MW; -2 flywheel(200kW) system app. \$1.6 million/MW, both prices without VAT and to be adjusted for relative scope.

⁷ WattsUp Power 2017: Standard solutions optimized to stabilize MV/LV power transformers in the power grid. The system is sold in modular configurations. Each module has a capacity of 100kWh and a peak discharge capacity of 1 MW capacity. Full system price in the range of 1.5 million Dkk/MW and for a 2 MW (200kWh)system in the range of 2.5 million Dkk/MW, both prices without VAT and to be adjusted for relative scope.

One major reason for the dramatic decrease in flywheel prices is a corresponding decrease in materials prices for materials (polymer composite materials) used for production of the flywheel itself. In 2017, 40% of the total investments cost, including BoP, for flywheels arises from rotor materials costs [15]. The reason for the materials price decrease is the considerable market expansion for windmills, which use the same kind of materials and manufacturing routines for turbine rotor blades. This decrease in materials prices is expected to continue for the coming decade.

Table 3 shows historical flywheel prices as well as recent up-to-date prices for flywheel systems. Looking at the prices in the table it is difficult to predict a significant tendency neither in energy price nor in power price.

Year of publication	Investment cost per energy storage capacity		Investment cost per discharge capacity		Reference
	\$/kWh*	M€/MWh (2015 prices)	\$/kW*	M€/MW (2015 prices)	
2001			230	0.35	19
2003			300	0.35	10
2010		9.3		2.3	Beacon Power ⁸
2010		5		6.4	Beacon Power ⁹
2011	4000	3.1	1500	1.1	20
2012	1000	0.81	250	0.20	9
2012	14000	11	25000	20	9
2013	300	0.23	1333	1.0	22
2014			130	0.10	15
2015	6500	5.9	24	0.02	23
2015	1340	1.2	3360	3.0	24
2015	1570	1.4	3920	3.5	24
2015	3000	2.7			25
2017		0.3		0.03	WattsUp Power
2017		2.0		0.20	WattsUp Power ¹⁰
2017		1.6		0.16	WattsUp Power ¹¹

Table 3: Overview of energy- and power prices for flywheel storage systems, from different references and years, prices are updated to 2017 based on CPI index change. *Price year is the year of the publication.

⁸ Table 2 Beacon Power, plant size: 1 MW

⁹ Table 2 Beacon Power, plant size: 0.2 MW

¹⁰ Table 2 WattsUp Power, plant size: 2 MW

¹¹ Table 2 WattsUp Power, plant size: 1 MW

Maintenance

Maintenance costs decreased considerably from 2009 to 2017, as shown by information from Beacon Power 2009 and WattsUp Power 2017.

Data from Beacon Power 2009:

- Detailed operating and maintenance manuals available
- No onsite operator presence
- Remotely monitored
- Specific faults shut down systems and notify operators
- Flywheels monthly visual inspections
- Monthly BOP maintenance (pumps/fans/chillers/etc.)
- ~4-5% of capital cost/year

Data from WattsUp Power 2017:

- Detailed operating and maintenance manuals are available.
- No onsite operator presence.
- Remotely monitored.
- Specific errors/malfunxions shut down systems and notify operators.
- Flywheels yearly visual inspections.
- Maintenance cost < 1% of capital cost/year.
- Product life time +25 years on mechanics and 15 years on electronics.

The demand for inspection is reduced from once each month to once a year and the expected yearly cost of maintenance is reduced from 4-5% of capital cost to 0.01% of capital cost p.a. At the same time, the expected capital cost for WattsUp Power flywheel is a fifth to a tenth of the cost of Beacon Power meaning that the maintenance cost for a WattsUp Power flywheel in 2017 is less than 1 % of the maintenance cost for a Beacon Power flywheel in 2009.

Lifetime

The expected lifetime for a flywheel system in 2017 is in the range of 20-25 years for the wheel or more than 1,000,000 cycles.

Losses from flywheels are low and can be down to the range of 1%/year when left in a spinning state [16]. The practical number however is 5% (WattsUp).

Reliability: Mean time between failures 3.400.000 hours (Beacon Power).

Prediction of price and performance

As mentioned above a significant decrease of material prices for manufacturing the flywheel rotors has been seen over recent years and this development is believed to continue in years to come. Since the cost of the rotor in 2017 is about 40% of system costs a decrease in materials prices has a significant impact on the full system cost. This is the explanation why flywheel system prices have recently decreased up to 30%/year and is expected to continue decreasing significantly over the next decades.

The price prediction data given in Table 4 below are based on an evaluation of how the price decrease development can be anticipated towards 2050. In fact, the materials and production technology used for the wheels themselves are the same as used in wind turbine industry for rotor blades. The strong demand for new and more efficient wind turbines at lower price has driven a correspondingly strong decrease in materials prices, which has in turn had a parallel impact on flywheels. The same development is anticipated to go on approx. for the next 10 years supported also by learning processes and increased production volume. After 2025 a much more controlled – although still decreasing – price development for flywheel systems is expected.

Uncertainty

As described in the above section there is uncertainty to the flywheel price projection shown in the present document (Table 4 below). 40% of this uncertainty is linked to the corresponding development in wind turbine rotor blades and this effect is expected to decrease in the years towards 2050 due to increasing maturity of composite production technology. The remaining 60% of system price concerns more mature and well-known technology (e.g. electronics and control system), where the price projection is less uncertain. The price projection shown in Table 4 results from summing the estimations from the two contributions.

System delivery time

Delivery time for a flywheel system will depend somewhat on the local site schedule including permits from relevant authorities. But it seems that the delivery time in 2017 has been reduced to about half of the delivery time in 2009.

In 2009 Beacon Power informed that an optimistic schedule for flywheel delivery would be

- For purchase of 1-2 flywheels 0.1 MW approx. 9 months
- For purchase of 1 MW module around 12-15 months
- For purchase of 20 MW SEM initial operation after 12-15 months and full operation after 15 months

In 2017 WattsUp Power informed that delivery time for a flywheel system is 3-6 months, including planning. Laboratory tests are available within 2 – 4 weeks.

Quantitative description

Technology	Flywheels									
	2018	2020	2030	2050	Uncertainty (2020)	Uncertainty (2050)	Note	Ref		
Energy/technical data					Lower	Upper	Lower	Upper		
Form of energy stored	Electro-mechanical energy									
Application	Short and medium term grid services									
Energy storage capacity for one unit (MWh)	0,1	0,1	0,1	0,1	0.1	0.1	0.1	0.15	A, F, M	
Output capacity for one unit (MW)*	1	1	1	1	1	1	1	1.5	A, F, M	
Input capacity for one unit (MW)*	1	1	1	1	1	1	1	1.5	A, F, M	
Round trip efficiency (%)	98	98	98	98	98	99	98	99	G, M	
- Charge efficiency (%)	99	99	99	99	99	99.5	99	99.5	G, M	
- Discharge efficiency (%)	99	99	99	99	99	99.5	99	99.5	G, M	
Energy losses during storage (%/day)	5	3	1	1	2	5	0.5	1.5	H	[16]
Auxiliary electricity consumption (% of output)	0								C	
Forced outage (%)	0									[17]
Planned outage (weeks per year)	0									
Technical lifetime (years)	20	20	25	25	20	25	20	25	B, M	[17]
Construction time (years)	0.5	0.25	0.25	0.25	0.25	0.25	0.25	0.25	A, M	
Regulation ability										
Response time from idle to full-rated discharge (sec)	0.003	0.003	0.003	0.003	0.003	0.003	0.003	0.003	D, M	
Response time from full-rated charge to full-rated discharge (sec)	0.003	0.003	0.003	0.003	0.003	0.003	0.003	0.003	D, M	
Financial data										
Specific investment (M€2015 per MWh)	1	0.335	0.335	0.335	0.3	0.36	0.3	0.36	E, J, L	[18]
- energy component (M€2015 per MWh)	1	0.33	0.33	0.33	0.3	0.36	0.3	0.36	D	
- capacity component (M€2015 per MW)	0.1	0.1	0.1	0.1	0.1	0.1	0.09	0.1	D	
Fixed O&M (€2015/MW/year)	750	750	750	750	750	750	750	750	D, M	
Variable O&M (€2015/MWh)									I	[7]
Technology specific data										
Specific investment (M€2015/MW)	0.164	0.145	0.136	0.131	0.14	0.15	0.13	0.14	A	[18]
Specific energy (Wh/kg)	115	350	350	350	300	400	350	400	A	
Specific energy (Wh/l)	500	1500	1500	1500	1300	2000	1300	2000	A	
Cycle life	10 ⁶	10 ⁶	10 ⁶	10 ⁶	10 ⁶	10 ⁷	10 ⁶	10 ⁷	A	

Notes

- A. Data informed by WattsUp Power February 2018
- B. +25 years on mechanics. 15 years on electronics. Informed by WattsUp Power March 2017
- C. 150 W during upstart procedure for 7 min informed by WattsUp Power. After upstart auxiliary power is included in round trip efficiency
- D. Informed by WattsUp Power February 2018
- E. Confer also Table 2
- F. Please note that the mentioned 1 MW is standard size *of one unit* that can be assembled to larger entities functioning as “larger units” (somewhat similar to the case of cells in batteries). The displayed financial data is for a 2 MW plant. Flywheels can be connected and provide 20 MW regulation power and several MWh of storage capacity (this size is in commercial operation cf. Figure 5 above). Higher capacities can be obtained and the price per unit decreases when several units are purchased.
- G. Informed by WattsUp Power February 2018
- H. Loss per day measured by WattsUp Power. The projected losses towards 2050 is justified by results already now obtained by NASA
- I. The variable costs of flywheels are not directly related to the power put in and out. The data is based on storing (and discharging) 33 MWh per day in 350 days per year. Data from WattsUp Power.
- J. Displayed price information is based on recent WattsUp Power sales prices for two units (each 1 MW, 100 kWh). Price for one unit of 1 MW and 100 kWh is approx. 0.1 mill EUR. If several units are purchased unit price may be lower than by purchase of two units.
- K. Based on plans for increasing rotational speed by a factor 3 (WattsUp Power)
- L. The non-flywheel costs depend on the use of the flywheel. Demanding use patterns may increase non-flywheel costs from the 5 kEUR (as included here) to 75 kEUR per MWh
- M. Future uncertainties based on author’s best assessment

References

- [1] "<http://www.elp.com/articles/2016/01/amber-kinetics-signs-flywheel-energy-storage-contract-with-pge.html>," 2016. [Online]. [Accessed March 2017].
- [2] e. a. I. Gyuk, "Grid Energy Storage," US Department of Energy, 2013.
- [3] S.-i. Inage, "Prospects of Electricity Storage in Decarbonised Power Grids, IEA Working Paper Series," OECD/IEA, 2009.
- [4] "Toshiba Leading Innovation," Toshiba. [Online]. [Accessed March 2017].
- [5] "Fact sheet. Frequency Regulation and Flywheels," Beacon Power, 2010. Archived March 2017. Available on https://web.archive.org/web/20100331042630/http://www.beaconpower.com/files/Flywheel_FR-Fact-Sheet.pdf.
- [6] "<http://beaconpower.com>," Beacon Power. [Online]. [Accessed March 2017].
- [7] B. Z. a. S. Syri, "Electrical Energy Storage Systems: A comparative life cycle cost analysis," Renewable and Sustainable Energy Reviews, vol. 42, pp. 569-596, 2015.
- [8] I. P. ., E. S. Gyuk, "EPRI-DOE Handbook of Energy Storage for Transmission & Distribution Applications 1001834," US Department of Energy, Washington, 2003.
- [9] "timesunion," Times Union, 2011. [Online]. [Accessed March 2017].
- [10] "Joint EASE/EERA recommendations for a European Energy Storage Technology Development Roadmap towards 2030," EASE and EERA, Brussels, 2013.
- [11] "Technology Roadmap, Energy Storage," International Energy Agency, Paris, 2013.
- [12] N. K. Kohli, "Short-Term backup power through flywheel energy storage system. Available on <https://www.slideshare.net/Drnavinkumarkohli/ppt-fly-wheel-navin-kohli> (Accessed March 2017)," 2012.
- [13] S. o. A. E. I. SAE, "https://global.ihs.com/doc_detail.cfm?rid=GS&&item_s_key=00138611," IHS Markit, 2013. [Online]. [Accessed March 2017].
- [14] "Electrical Energy Storage," International Electrotechnical Commission, Geneva, Switzerland, 2011.
- [15] 2. Private communication with WattsUp Power.
- [16] W. Torell, "Lifecycle Carbon Footprint Analysis of Batteries vs. Flywheels, White Paper 209," Schneider Electric, 2015.

- [17] W. V. H. Susan M. Schoenung, "Long- vs. Short-Term Energy Storage Technologies Analysis. A Life-Cycle Cost Study," Sandia National Laboratories, Albuquerque, New Mexico 87185 and Livermore, California 94550, 2003.
- [18] "Lazard's levelized cost of storage - Version 2.0," Lazard, 2016.
- [19] e. a. P. Tayler, "Pathways for Energy Storage in the UK, Report 007," The Centre for Low Carbon Futures, March 2012.
- [20] "<https://www.calnetix.com/resource/flywheels/advantages-flywheels>," Calnetix. [Online]. [Accessed March 2017].
- [21] "<http://www.climatetechwiki.org/technology/jiqweb-es-fw>," [Online].
- [22] P. N. N. L. Daryl Brown, "Federal Technology Alert. DOE/EE-0286," Federal Energy Management Program, 2003.
- [23] "InflationData.com," InflationData, 2017. [Online]. [Accessed 2017].
- [24] "Materials Roadmap Enabling Low Carbon Energy Technologies, Commission Staff Working Paper," European Commission, Brussels, 2011.
- [25] "energy.gov," 2010. [Online]. [Accessed March 2017].
- [26] "Scientific American," Scientific American, 2011. [Online]. [Accessed March 2017].
- [27] e. a. M. Hedlund, "Flywheel Energy Storage for Automotive Applications," *Energies*, vol. 8, pp. 10636-10663, 2015.
- [28] 2009. [Online]. [Accessed March 2017].
- [29] Memoori, Smart Building Resesearch, 2017. [Online]. [Accessed MArch 2017].

180 LITHIUM-ION BATTERIES FOR GRID-SCALE STORAGE

Contact information

Danish Energy Agency: Thomas Mandal Østergaard , tmo@ens.dk

Energinet.dk: Rune Duban Grandal, rdg@energinet.dk

Author: Rasmus Rode Mosbæk, rasmus@hybridgreentech.com, Hybrid Greentech ApS

Author: Søren Højgaard Jensen, soren@hybridgreentech.com, Hybrid Greentech ApS

Publication date

January 2019

Amendments after publication date

Date	Description
15.03.2019	Corrections to the notes in the datasheet.
07.02.2019	A few errors in the datasheet has been corrected.

Content

Brief technology description

How does a Lithium-ion battery work?

Lithium-ion chemistries

Lithium-ion battery packaging

Components in a lithium-ion battery energy storage system

Input/Output

Energy efficiency and losses

Operational losses

Standby losses

Energy Efficiency

Regulation ability and other system services

Typical characteristics and capacities

Typical storage period

Space requirement

Advantages/disadvantages

Environment

Research and development perspectives

Examples of market standard technology

Prediction of performance and cost

Uncertainty

Data sheet

Frequency regulation and renewable energy integration cost examples

Acknowledgement

References

Brief technology description

How does a Lithium-ion battery work?

A lithium-ion battery or Li-ion battery (abbreviated as LIB) can store electric energy as chemical energy. Both non-rechargeable and rechargeable LIBs are commercially available. The non-rechargeable LIBs (also called primary cells) have long shelf-life and low self-discharge rates, and are typically fabricated as small button cells for e.g. portable consumer electronics, arm watches and hearing aids. Rechargeable LIBs (also named secondary cells) are applied in all kinds of consumer electronics, and is currently entering new markets such as electric vehicles and large-scale electricity storage. The rechargeable LIBs can be used to supply system level services such as primary frequency regulation, voltage regulation and load shifting, as well as for local electricity storage at individual households. Below we only focus on the rechargeable LIBs.

A LIB contains two porous electrodes separated by a porous membrane. A liquid electrolyte fills the pores in the electrodes and membrane. Lithium salt (e.g. LiPF_6) is dissolved in the electrolyte to form Li^+ and PF_6^- ions. The ions can move from one electrode to the other via the pores in the electrolyte and membrane. Both the positive and negative electrode materials can react with the Li^+ ions. The negative electrode in a LIB is typically made of carbon and the positive of a Lithium metal oxide. By convention, the negative and the positive electrode are also called the anode and the cathode respectively. Electrons cannot migrate through the electrolyte and the membrane physically separates the two electrodes to avoid electrons crossing from the negative to the positive electrode and thereby internally short circuiting the battery. The individual components in the LIB are presented in Figure 1.

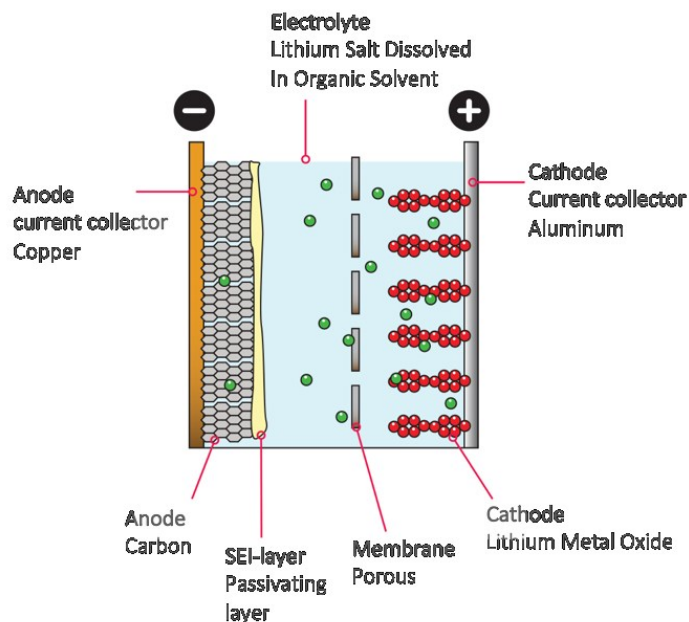

Figure 1. Schematic diagram of a typical LIB system displaying the individual components in the battery.

When the two electrodes are connected via an external circuit the battery start to discharge. During the discharge process electrons flow via the external circuit from the negative electrode to the positive. At the same time Li^+ ions leaves the negative electrode and flows through the electrolyte towards the positive electrode where they react with the positive electrode. The process runs spontaneously since the two electrodes are made of different materials. In popular terms the positive electrode “likes” the electrons and the Li^+ ions better than the negative electrode.

The energy released by having one Li^+ ion, and one electron, leaving the negative electrode and entering the positive electrode is measured as the battery voltage times the charge of the electron. In other words the battery voltage - also known as the *electromotive force*: *EMF* - measures the energy per electron released during the discharge process. *EMF* is typically a around 3-4 Volts and depends on the LIB cell chemistry, the temperature and the state of charge (SOC – see below). When e.g. a light bulb is inserted in the external circuit the voltage primarily drops across the light bulb and therefore the energy released in the LIB is dissipated in the light bulb. If the light bulb is substituted with a voltage source (e.g. a power supply) the process in the battery can be reversed and thereby electric energy can be stored in the battery.

The discharge and charge process is outlined in Figure 2. The battery is fully discharged when nearly all the Lithium have left the negative electrode and reacted with the positive electrode. If the battery is discharged beyond this point the electrode chemistries become unstable and start degrading. When the LIB is fully discharged the *EMF* is low compared to when it is fully charged. Each LIB chemistry has a safe voltage range for the *EMF* and the endpoints of the range typically define 0% and 100% state of charge (SOC), and the safe voltage range prevents complete Lithium removal. The discharge capacity is measured in units of Ampere times hours, Ah, and depends on the type and amount of material in the electrodes. Overcharging, or prolonged storage at high SOC also accelerates degradation.

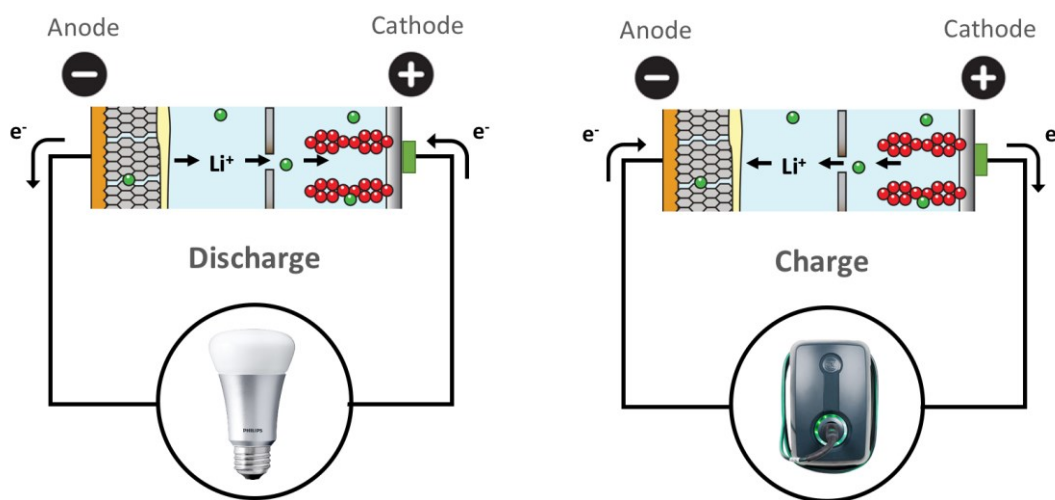

Figure 2. Schematic diagram of a LIB system in charge and discharge mode. During discharge the green Li^+ ions moves from the negative electrode (left side) to the positive electrode. The process is reversed during charge mode (right side).

The first lithium batteries were developed in the early 1970s and Sony released the first commercial lithium-ion battery in 1991. During the '90s and early 2000s the LIBs gradually matured via the pull from the cell-phone market. The Tesla Roadster was released to customers in 2008 and was the first highway legal serial production all-electric car to use lithium-ion battery cells. Further, around 2010 the LIBs expanded into the energy storage sector.

Lithium-ion chemistries

Table 1 shows a comparison of the three most widely used LIB chemistries for grid-connected LIB systems and the major manufactures. Other LIB chemistries such as LCO, LMO and NCA are generally not used for first life grid electricity storage and are therefore not included in the table. The numbers in the table are taken from cell manufactures, product or system suppliers. NMC is the most widely used of the three chemistries due to the increased production volume and lower prices lead by the automotive sector. The NMC battery has a high energy density but uses cobalt. The environmental challenges in using cobalt are described in the section: "Environment".

The LFP battery do not use cobalt in the cathode, but are not as widely used as NMC, and are therefore generally higher priced, primarily due to the lower production volumes.

Both NMC and LFP batteries have graphite anodes. The main cause for degradation of NMC and LFP LIBs is graphite exfoliation and electrolyte degradation which in particular occur during deep cycling when the SOC is decreased below 10%.

LTO LIBs are the most expensive cell chemistry of the three. In LTOs the graphite anode is replaced with a Lithium Titanate anode. The cathode of a LTO battery can be NMC, LFP or other battery cathode chemistries. The LTO battery is characterized by long calendar lifetime and high number of cycles.

Short name	Name	Anode	Cathode	Energy density Wh/kg	Cycles	Calendar life	Major manufactures	References
NMC	Lithium Nickel Manganese Cobalt Oxide	Graphite	Li Ni _{0.6} Co _{0.2} Mn _{0.2} O ₂	120-300	3000-10000	10-20 years	Samsung SDI LG Chem SK Innovation Leclanche Kokam	[1-5]
LFP	Lithium Iron Phosphate	Graphite	LiFePO ₄	50-130	6000-8000	10-20 years	BYD/Fenecon Fronius/Sony*	[6,7]
LTO	Lithium Titanate	LiTO ₂	LiFePO ₄ or Li Ni _{0.6} Co _{0.2} Mn _{0.2} O ₂	70-80	15000-20000	25 years	Leclanche Kokam Altairnano	[1,3,4,8]

Table 1. A comparison of four widely used LIB chemistries.

*Residential energy storage system. All other systems are multi-MWh size.

Lithium-ion battery packaging

The most common packaging styles for LIB cells are presented in Figure 3. Examples are provided in Figure 4. Figure 3(a) show a schematic drawing of a cylindrical LIB cell. Cylindrical cells find widespread applications ranging from laptops and power tools to Tesla's battery packs. Figure 4(a) shows Tesla's 21700 cylindrical LIB cell which is 21 mm in diameter and 70 mm in length. The cell is produced in Tesla's Gigafactory 1 for Tesla Model 3 [9]. Figure 3(b) outline a coin LIB cell. Coin cells are usually used as primary cells in portable consumer electronics, watches and hearing aids. Since they are not used for secondary cells (rechargeable) in grid-connected LIB Battery Energy Storage Systems they are not described further in this text. Figure 3(c) displays a schematic drawing of a prismatic LIB cell. Prismatic LIB cells are often used in industrial applications and grid-connected LIB Battery Energy Storage Systems. The Samsung SDI prismatic LIB cell is shown in Figure 4(b). This cell type is used in the BMW i3 [10]. Figure 3(d) shows a schematic drawing of a pouch LIB cell. Figure 4(c) shows an LG Chem pouch NMC LIB cell used in LG Chem's grid-connected LIB Battery Energy Storage Systems. Pouch LIB cells are also used in electric vehicles such as the Nissan Leaf [11].

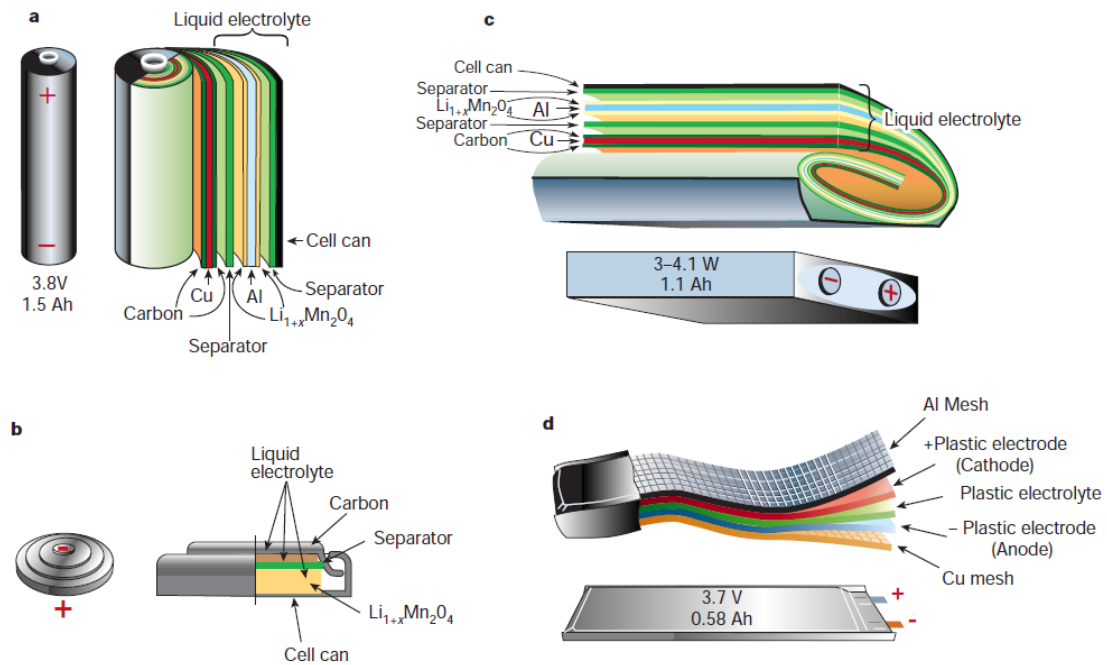

Figure 3. Schematic drawing showing the shape, packaging and components of various Li-ion battery configurations [12]. (a) Cylindrical; (b) coin; (c) prismatic; and (d) pouch.



Figure 4. Examples of LIB cells. (a) Tesla 21700 cylindrical NMC LIB cell [13]. (b) Samsung SDI prismatic LIB cells [14]. (c) LG Chem pouch NMC LIB cell [15].

Components in a lithium-ion battery energy storage system

Figure 5 provides an overview of the components in a LIB storage system with interface to the power grid. In LIB storage systems battery cells are assembled into modules that are assembled into packs. The battery packs include a Battery Management System (BMS). The BMS is an electronic system that monitors the battery conditions such as voltage, current, and temperature and protects the cells from operating outside the safe operating area. A Thermal Management System (TMS) regulates the temperature for the battery and storage system. The TMS depends on the environmental conditions, e.g. whether the system is placed indoor or

outdoor. Further an Energy Management System (EMS) controls the charge/discharge of the grid-connected LIB storage from a system perspective. Depending on the application and power configuration the power conversion system may consist of one or multiple power converter units (DC/AC link). For system coupling a transformer may be needed for integration with higher grid voltage levels. The grid integration provides services to the grid such as increased reliability, load shifting, frequency regulation etc. The services are described further below in the section “Regulation ability and other system services”. Value generation and profit is created by selling the services to grid Transmission System Operators (TSOs). Battery capacity may be sold to the TSOs in full or partially, allowing for alternate use of the remaining capacity, for example local load management, energy trading or DSO services. Appropriate sizing of the battery and power conversion systems is essential to maximize the revenue. Technical and economic aspects of a battery storage system, system coupling and grid integration are summarized in Table 2.

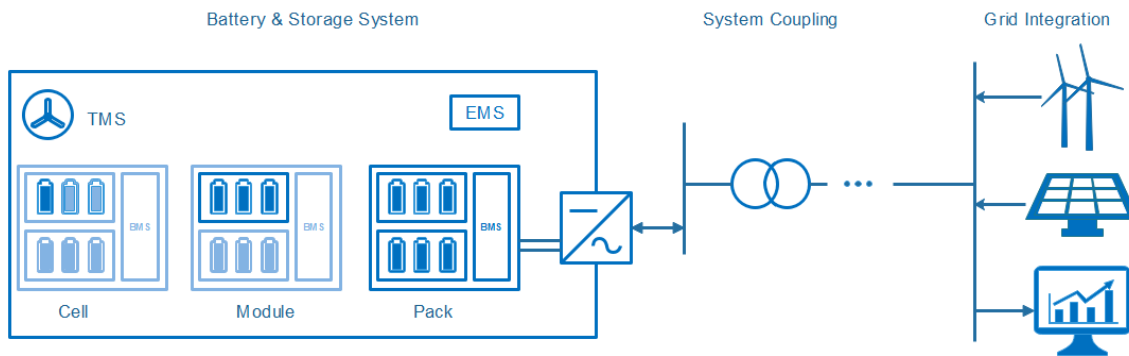

Figure 5. Schematic drawing of a battery storage system, power system coupling and grid interface components. Keywords highlight technically, and economically relevant aspects. Modified from [16].

	Battery & Storage System	System Coupling	Grid Integration
Technical	Battery System (Cell, Module, Pack) Battery Management System (BMS) Energy Management System (EMS) Thermal Management System (TMS)	Power Electronics (AC/DC) & Transformer Environmental Conditions	Application Specific Profile Local Connection / Grid Level of Integration Dispatching according to operator.
Economic	CAPEX: Battery system and sizing OPEX: Degradation and Efficiency Operation Control Strategy	CAPEX: Power Electronics/ Placement of System OPEX: Conversion Efficiency	CAPEX: Regulatory Framework OPEX: Regulatory Framework Profit / Savings via Application

Table 2. Formalized overview of the battery storage system, power system and grid interface components considering both technical and economic aspects. Modified from [16].

Input/Output

Input and output are both electricity. Electricity is converted to electrochemical energy during charge and converted back to electricity during discharge in the reaction process described in the section: “How does a Lithium-ion battery work?”.

Energy efficiency and losses

The losses in a LIB can be divided in operational and standby losses. The operational losses are first described, then the standby losses. Finally the energy efficiency is discussed.

Operational losses

The operational losses occur when energy is discharged or charged to/from the grid. It includes the conversion losses in the battery and the power electronics.

When the LIB is not operated its voltage U equals the EMF . However, during discharge or charge the battery voltage U change due to current I passing the internal resistance R_i in the LIB. The voltage change ΔU can be described using Ohms law

$$\Delta U = U - EMF = R_i I \quad (1)$$

and the loss in the internal resistance is defined as

$$P_{\text{loss}} = \Delta U I = R_i I^2 \quad (2)$$

Equation (2) explains how the loss increases with increasing current.

The LIB provides a DC current during discharge and needs a DC current input for charging. Before the electricity is sent to the grid the inverter converts the DC current to AC. The inverter loss typically increases gradually from around 1% to 2% when increasing the relative conversion power from 0% to 100% [17].

Standby losses

Unwanted chemical reactions cause internal current leakage in the LIB. The current leakage leads to a gradual self-discharge during standby. The self-discharge rate increases with temperature and the graph below shows the remaining charge capacity as function of time and temperature for a LIB. The discharge rate is the slope of the curve and is around 0.1% per day at ambient temperature.

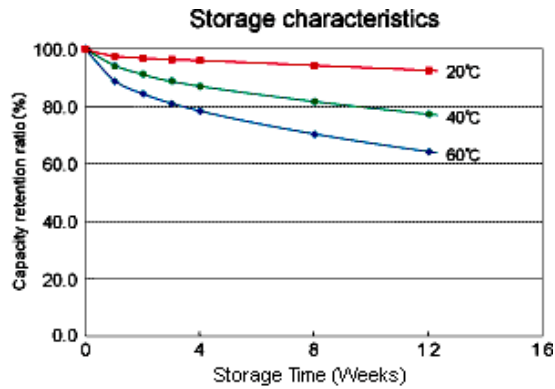

Figure 6. Remaining charge capacity for a typical LIB as function of storage time [18].

Besides the self-discharge in the cell, a LIB electricity storage system requires power to operate the auxiliary balance of plant (BOP) components. Figure 5 outlines the BOP components which include the inverter, BMS, EMS and TMS. The relative energy loss to the BOP components depends on the application, and a careful operation strategy is important to minimize their power consumption [17]. The standby loss E_{stb} is the sum of the energy losses during standby due to self-discharge and power consumption in the BOP components.

Energy Efficiency

The conversion roundtrip efficiency of the LIB cell is the discharged energy divided with the charged energy. The battery conversion efficiency decreases with increasing current since the P_{loss} increases. An example of a LIB cell conversion efficiency is shown in Figure 7. The C-rate is the inverse of the time it takes to discharge a fully charged battery. At a C-rate of 2 it takes ½ hour and at a C-rate of 6 it takes 10 minutes.

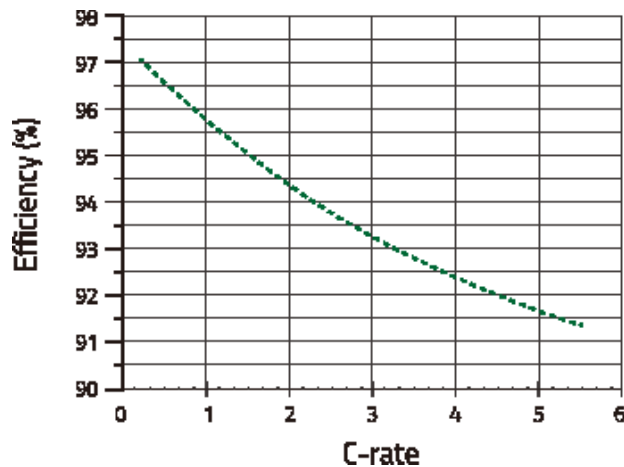

Figure 7. Conversion round trip efficiency vs. C-rate for one of Kokam's NMC-based lithium polymer batteries [19].

The system conversion roundtrip efficiency $\eta_{\text{Conversion}}$ considers losses which occur on the conversion path from the energy charged $E_{\text{Charge,AC}}$ and the energy discharged $E_{\text{Discharge,AC}}$ from/to the grid. It includes the conversion losses in the battery and power electronics

and can be written as

$$\eta_{\text{Conversion}} = \frac{E_{\text{Discharge,AC}}}{E_{\text{Charge,AC}}} \quad (3)$$

The total roundtrip efficiency η_{Total} further includes the standby losses:

$$\eta_{\text{Total}} = \frac{E_{\text{Discharge,AC}}}{E_{\text{Charge,AC}} + E_{\text{stb}}} \quad (4)$$

Here E_{stb} denotes the energy required from the grid to continuously operate BOP and maintain state of charge. The various types of losses makes η_{Total} heavily dependent on the application. As an example, an 11 MW/4.4 MWh LIB system was installed in Maui, Hawaii for wind ramp management, essentially smoothing the output of an 21 MW wind farm [20]. The total roundtrip efficiency for this system is around 80 % [21]. Lazard uses an estimate of 85% [22]. To summarize, the total roundtrip loss typically consist of 2-5% related to the cell, 2-4% to the power electronics and the rest to standby losses.

Regulation ability and other system services

Grid-connected LIBs can absorb and release electrical energy fast. The response time of grid-connected LIBs are strongly dependent on control components, EMS, BMS and TMS as well as the power conversion system (PCS).

The competitive installation cost (outlined below) makes grid-connected LIB BESS (Battery Energy Storage System) suitable for a broad range of applications [23] such as **peak load shaving** where the BESS provides or recieves energy to reduce peaking in a power system. In relation to this BESS can promote **renewable integration**, e.g. time or load shifting of photovoltaic power from day to night. Further the BESS can provide **transmission congestion relief** where locally deployed BESS reduces the load in the transmission and distribution system. In this way the BESS can help defer expensive upgrades of the transmission and distribution network.

The fast response time enables the use of BESS for a broad range of primary control provisions. These include **Frequency regulation** where the BESS are used to alleviate deviations in the AC frequency. Today, frequency regulation is the main application of stationary BESS systems deployed worldwide. The BESS can also be used to improve network **reliability** by reacting immediately after a contingency. Here the BESS can help maintaining stability in the power system until the operator has re-dispatched generation. Moreover, the BESS can effectively be used for **black-starting** distribution grids and LIB-BESS systems are suitable for enhancing the **power quality** and reducing **voltage deviations** in distribution networks. The BESS can further be used to

provide *spinning reserves* and regulate *active and reactive power* thereby improving the network voltage profile. This can improve the integration of renewable energy.

Typical characteristics and capacities

The frame or shelf that holds the batteries is called a rack, i.e. the battery pack (Figure 5) without the BMS. The energy per rack is typically 60-166 kWh [2,24] and the size is e.g. 415mm x 1067 mm x 2124 mm (W x D x H) for a 111kWh rack from Samsung SDI [2] and 520 mm x 930 mm x 2200 mm (W x D x H) for a 166.4 kWh rack from LG Chem [24]. Both companies use the NMC chemistry. The weight of the Samsung SDI rack is 1170 kg and the C-rate is 0.5 during charge and up to 6 during discharge [2]. For the LG Chem system the weight is 1314 kg. This gives an energy density of 118 kWh/m³ and 0.095 kWh/kg for the Samsung SDI system and 156 kWh/m³ and 0.127 kWh/kg for the LG Chem system. The C-rate for the LG Chem systems ranges from around 0.3 to +1 but is not specified in detail. For this reason the Samsung SDI system is used to specify energy and power density in the data sheet (Table 3). For the Samsung SDI system the power density in charge-mode is 50 kW/m³ and 0.047 kW/kg. In discharge-mode it is 708 kW/m³ and 0.569 kW/kg.

Typical storage period

Several aspects of the LIB technology put an upper limit to the feasible storage period. The self-discharge rate makes storage periods of several months unfeasible. The BOP power for standby operation adds parasitic losses to the system which further limits the feasible standby time. Unwanted chemical reactions in the LIB gradually degrade the battery and limit the calendar lifetime. This calls for shorter storage periods in order to obtain enough cycles to reach positive revenue.

For LIBs the total number of full charge-discharge cycles within the battery lifetime is limited between a few thousands up to some ten-thousands. The exact number depends on the chemistry, manufacturing method, design and operating conditions such as temperature, C-rate and calendar time. This impacts the type of suitable applications. For instance due to the different degree of usage, the LTO chemistry may find more use on the FCR-N¹² market while others like NMC may be preferred for the FCR-D market.

LIB systems have been deployed to provide frequency response with a response time ranging from seconds to minutes [25], and the systems are increasingly used for renewables time shifting with typical storage periods of a few hours [17,25].

¹² FCR-N: Frequency Containment Reserve for Normal operation. FCR-D: Frequency Containment Reserve for Disturbances

Space requirement

The racks and battery packs are typically assembled in containers and the energy per 40 feet container is 4-6 MWh for NMC batteries [2,24]. The foot-print of a 40-feet container is 29.7 m². This gives a space requirement around 5-7.5 m²/MWh.

Advantages/disadvantages

Within the last decade the commercial interest for electricity storage using LIB systems has increased dramatically. The production volume is still limited and there is a promising potential for cost reductions through upscaling. The technology is stand-alone and requires a minimum of service after the initial installation.

Containers come in standard sizes. For small systems this impacts the LIB system CAPEX, however when the system size exceed several container units, the price can be considered fairly linear. Compared to e.g. fuel cell technology the CAPEX per storage capacity is relatively high. This is because the electricity is stored in the battery electrodes whereas for fuel cells the electricity is stored as a separate fuel. Adding incrementally more energy capacity to a battery system is therefore relatively expensive. The relatively high energy specific CAPEX combined with the gradual self-discharge and parasitic losses in the BOP make the technology less attractive for long-term storage beyond a few days.

Environment

A US-EPA report stated in 2013 that across the battery chemistries, the global warming potential impact attributable to LIB production including mining is substantial [26]. More specifically a recent review on life-cycle analysis (LCA) of Li-Ion battery production estimates that “on average, producing 1 Wh of storage capacity is associated with a cumulative energy demand of 328 Wh and causes greenhouse gas (GHG) emissions of 110 g CO_{2,eq}” [27].

The LIB cathode material NMC contains toxic cobalt and nickel oxides. About 60% of the global production of cobalt comes from DR Congo and the environmental health risks and work conditions in relation to the cobalt mining raises ethical concerns [28]. Visual Capitalist believes the cobalt content in NMC could decrease to 10% already in 2020 [29] from 20 % today by changing from a 6-2-2 ratio to a 8-1-1 ratio.

Starting about two years ago, fears of a lithium shortage almost tripled prices for the metal [30], and the demand for lithium will not fall anytime soon. According to Bloomberg New Energy Finance the electric car production alone is expected to increase more than thirtyfold by 2030. However, the next dozen years will drain less than 1 percent of the reserves in the ground, according to BNEF. One should be sceptic of this statement as battery makers are likely going to rapidly increase mining capacity to meet the demand.

Research and development perspectives

Currently a wide range of government and industry-sponsored LIB material, cell, and system level research is taking place. Some of the ongoing material research to further increase the energy density of LIB cells includes high-voltage electrolytes allowing charging voltages of up to 5 volts [31] and silicon nanoparticle based anodes

to boost the charge capacity [32]. Several research and development activities focus on improving the cycle lifetime of LMO cells [33–35].

Some of the most promising post Li-ion technologies include Lithium Sulphur batteries that use Sulphur as an active material. Sulphur is abundantly available at reasonable price and allows for very high energy densities of up to 400 Wh/kg. Also Lithium air batteries have received considerable attention. Since one of the active materials, oxygen, can be drawn from the ambient air, the lithium-air battery features the highest potential energy and power density of all battery storage systems. Due to the existing challenges with electrode passivation and low tolerance to humidity, large-scale commercialization of the lithium-air battery is not expected within the next years.

Several non-lithium-based battery chemistries are being investigated. Aluminum Sulphur batteries may reach up to 1000 Wh/kg with relatively abundant electrode materials, but are still in the very early development phase [36].

Besides the materials research, improved cell design, BMS, TMS and EMS technology and operation strategy can improve storage efficiency considerably [17].

Although LIB systems for electricity storage are now commercially available, the R&D is still in its relatively early phase and is expected to contribute to future cost reductions and efficiency improvements.

Examples of market standard technology

Grid scale turn-key LIB systems are commercially available from a wide range of suppliers. Referenced examples are shown in Table 3. Two larger grid-connected LIB systems are installed in Denmark: **A)** In Nordhavn, Copenhagen, Denmark a 630kW/460kWh was installed by ABB for Radius Elnet and Ørsted in 2017. This set the scene for Ørsted's first steps into commercial battery storage. For Ørsted the following energy storage projects are under development: a 20MW battery storage near Liverpool in UK and a 1 MW storage pilot project in Taiwan [37]. **B)** Lem Kær Wind Farm was Vesta's pilot project for energy storage which participates in the DK frequency regulation market. Vestas is working on Kennedy Power Plant that integrates wind and solar with grid-scale energy storage and will feature a 2MW / 4MWh grid-scale LIB storage system to provide ancillary services, test energy arbitrage and reduce curtailment.

Globally the two largest grid-scale LIB storage systems are the Mira Loma Substation in California which features 20MW/80MWh using 400 Tesla Powerpack 2 [38,39] and the Neoen's Hornsdale Wind Farm which features 100MW/129MWh [40], both systems provide peak shaving.

The Laurel Mountain, West Virginia, USA grid-scale LIB storage system at 32MW/8MWh [41] is designed for frequency regulation and with high power to energy ratio compared to the Tesla grid-scale LIB storage systems which are designed for peak shaving with a lower power to energy ratio.

Image	Location	Primary usage	Year	Power capacity	Techn. provider	Ref.
	Energylab Nordhavn, Copenhagen, Denmark	Frequency Regulation Peak Shaving Voltage Regulation Harmonic Filtering	2017	630 kW 460 kWh NMC	ABB for Radius Elnet / Ørsted	[42]
	Lem Kær Wind Farm, Denmark	Frequency regulation	2014	400kW LFP and 1.2MW LTO	Altairnano and A123 for Vestas	[43]
	Mira Loma Substation, California, USA	Peak Shaving	2016	20 MW 80 MWh	Tesla	[38,39]
	Neoen's Hornsdale Wind Farm, South Australia	Peak Shaving	2017	100 MW 129 MWh	Tesla	[40]
	Laurel Mountain, Belington, West Virginia, USA	Frequency Regulation and Renewable Energy Integration	2011	32 MW 8 MWh	AES and A123	[41]

Table 3. Example of market standard technology for grid-connected LIB systems.

Prediction of performance and cost

The recent industry average LIB pack cost forecast taken from Bloomberg's New Energy Outlook 2018 is shown in Figure 8 [44]. The current LIB price is close to 200\$/kWh and the forecast (dotted line) predicts a battery price of 70 \$/kWh by 2030. Further, the forecasted added installed capacity between now and 2050 is estimated to 1291 GW [44]. Using Bloombergs 18% learning rate and the predicted capacity growth, this results in a forecasted 50\$/kWh in 2040 and 40 \$/kWh in 2050.

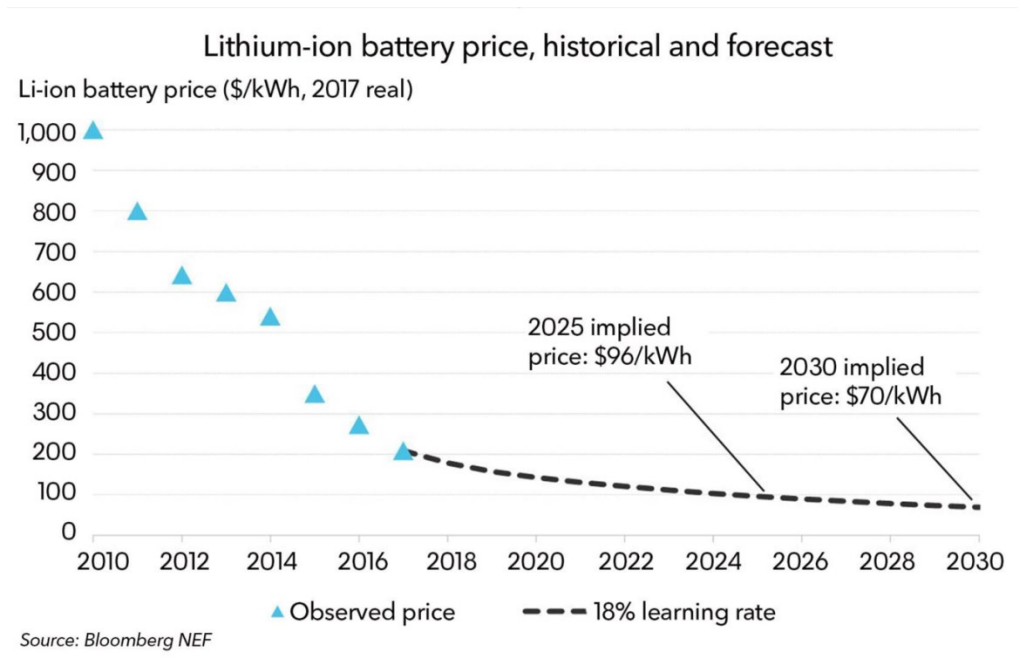

Figure 8: Historical and forecasted Lithium-ion battery pack cost [44].

TESLA through its Gigafactory is reported to be 4-5 years ahead of the industry average with a pack cost level of US\$190/kWh already in 2016 and indications have been reported of US\$ 100/kWh before 2020 [45] and US\$ 80/kWh soon thereafter [46].

The cost reductions are backed up by a rapid increase in the LIB production capacity as shown in Figure 9. The production capacity is expected to grow from 28 GWh in 2016 to 174 GWh by 2020 representing an impressive five-fold growth in four years [47].

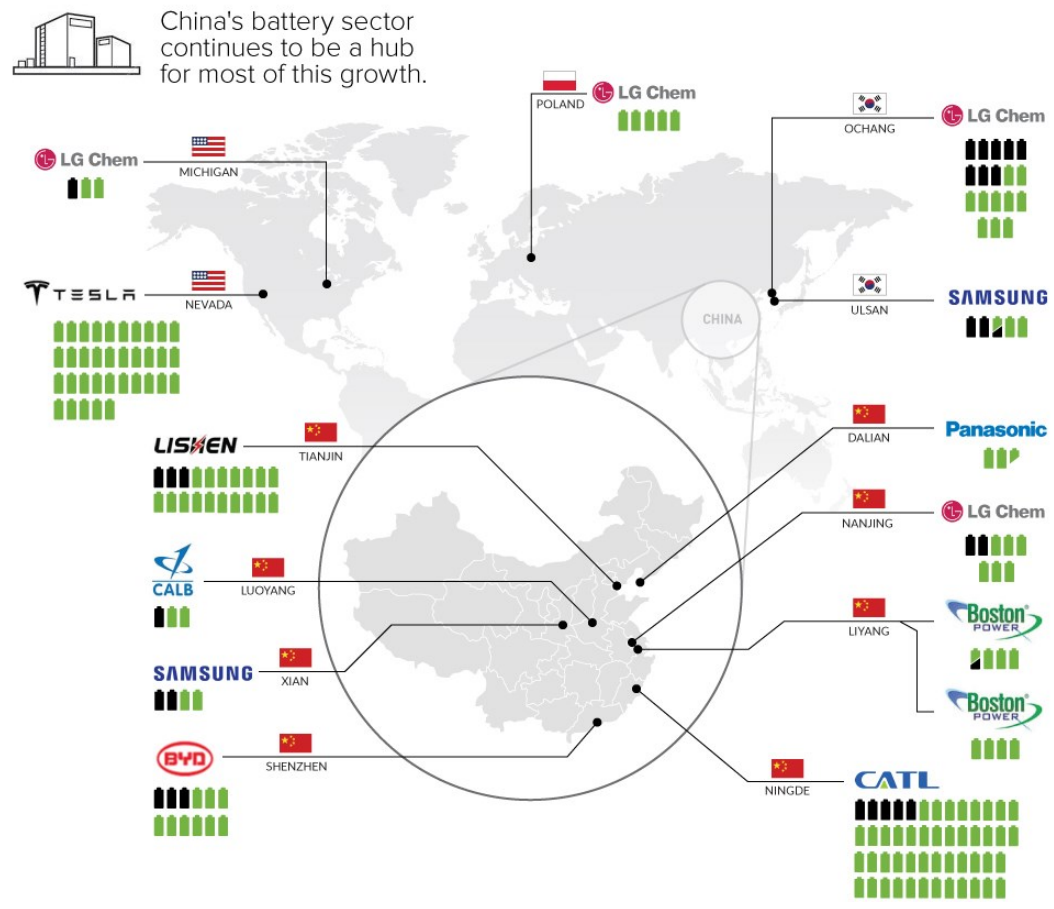
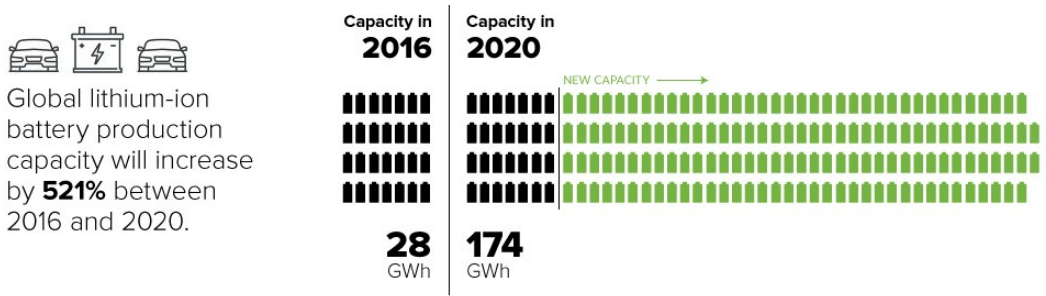

Figure 9: Projected growth in LIB manufacturing capacity over next few years, total and divided on technology producers [47]. Each battery represents a production capacity of one GWh per year.

The forecasted decrease in battery pack cost (Figure 8) and increase in production capacity (Figure 9) aligns with a forecasted steep growth rate of the utility-scale application market as shown in Figure 10. The installed capacity is estimated to reach 14 GW in 2023 [48]. Globaldata predicts this capacity level could be reached already in 2020 [49].

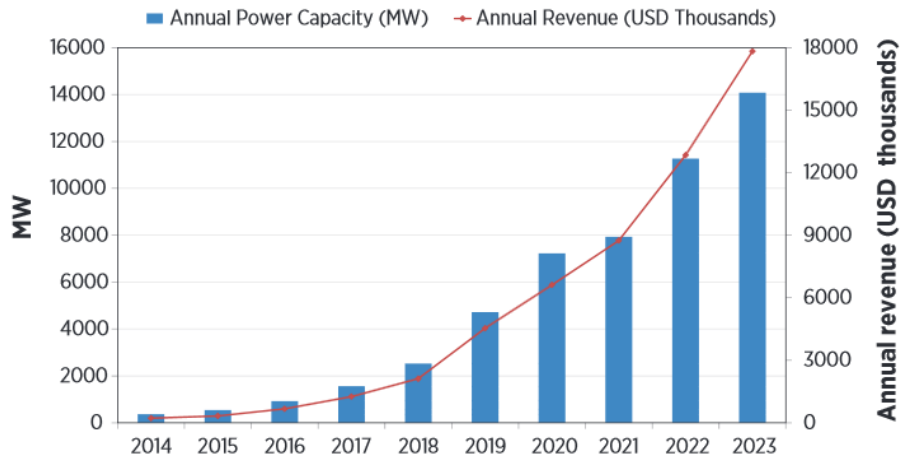

Figure 10: Worldwide forecast of battery storage capacity (MW) and annual revenue (USD) for utility-scale applications [48].

Uncertainty

The LIB price forecasts imply a broad range of uncertainties. If the learning rate is not 18% as estimated in Bloomberg’s New Energy Outlook 2018 [44], but rather 12-16% as estimated earlier [50], the forecasted price reductions will be smaller. Having a 12% learning rate, the 2050 price ends at 70 \$/kWh instead of 40 \$/kWh. With a 14% and 16% learning rate the 2050 price ends respectively at 60 \$/kWh and 50 \$/kWh.

As shown in Figure 11 Tesla/Panasonic seems 4 to 5 years ahead of the industry average cost per kWh. The figure also indicates differences in the forecasted cost reduction. The Tesla forecast indicates pack prices as low as 50 \$/kWh already in 2025.

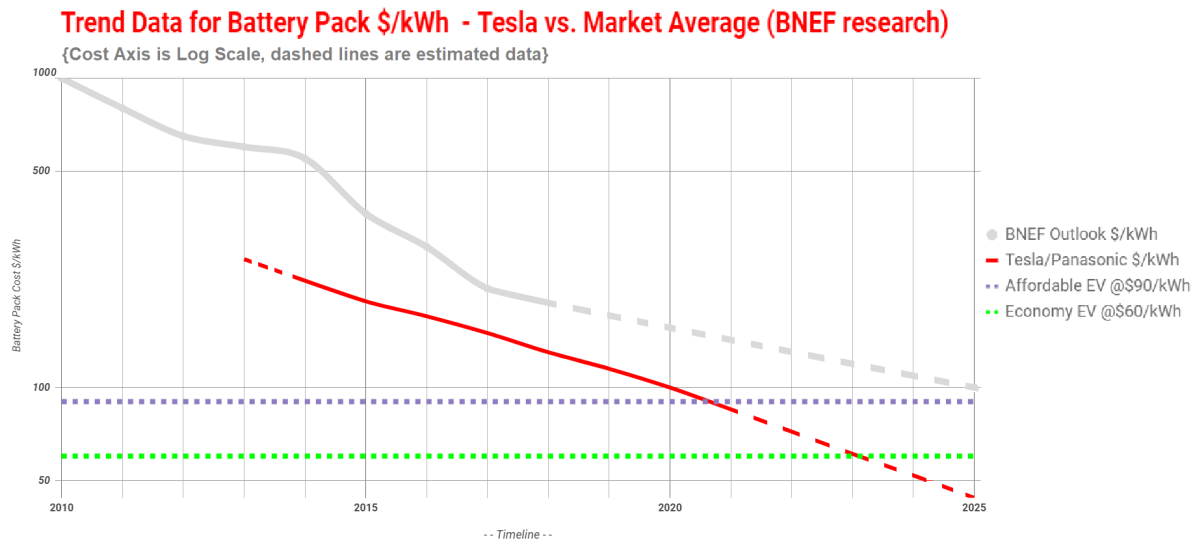

Figure 11: Trend data for Tesla/Panasonic vs. Bloombergs forecasts for LIB pack cost [44,45].

The spread in the current and predicted price shown in Figure 11 indicates a substantial uncertainty in the current and forecasted cost. The estimated 90% confidence interval is 170-80 \$/kWh in 2020 and for the 2050 LIB price is estimated to be 30-75 \$/kWh.

Data sheet

The data sheet table summarizes the development predictions. The assumptions for the predictions are discussed in the sections above.

Technology	Lithium-ion NMC battery (Utility-scale, Samsung SDI E3-R135)											
	2015	2020	2030	2040	2050	Uncertainty (2020)		Uncertainty (2050)		Note	Ref	
Energy/technical data						Lower	Upper	Lower	Upper			
Form of energy stored	Electricity											
Application	System, power- and energy-intensive											
Energy storage capacity for one unit (MWh)	3.2	6	7	8	8	5	9	7	12	A	[2,14]	
Output capacity for one unit (MW)	9.6	18	21	24	24	16	21	22	28	A,B	[2,14]	
Input capacity for one unit (MW)	1.6	3	3.5	4	4	2.7	3.5	3.7	4.7	A,B	[2,14]	
Round trip efficiency (%) AC	91	91	92	92	92	90	92	91	94	C	[3,21,22,51]	
Round trip efficiency (%) DC	95	95	96	96	96	95	96	95	97	C	[3,21,22,51]	
- Charge efficiency (%)	98	98	98.5	98.5	98.5	98	98.5	98	99	D	[2]	
- Discharge efficiency (%)	97	97	97.5	97.5	97.5	97	98	97	98	D	[2]	
Energy losses during storage (%/day)	0.1	0.1	0.1	0.1	0.1	0.05	0.2	0.05	0.15	E	[18,50,52]	
Forced outage (%)	0.4	0.38	0.35	0.3	0.25	0.2	0.5	0.1	0.3	F		
Planned outage (weeks per year)	0.2	0.2	0.1	0.1	0.1	0.1	0.25	0.05	0.2	F		
Technical lifetime (years)	15	20	25	30	30	15	25	20	45	G	[3,5,8,14]	
Construction time (years)	0.25	0.2	0.2	0.2	0.2	0.2	0.25	0.1	0.25		[38]	
Regulation ability												
Response time from idle to full-rated discharge (sec)	<0.08	<0.08	<0.08	<0.08	<0.08	<0.08	<0.08	<0.08	<0.08	H	[53]	
Response time from full-rated charge to full-rated discharge (sec)	<0.08	<0.08	<0.08	<0.08	<0.08	<0.08	<0.08	<0.08	<0.08	H	[53]	
Financial data												
Specific investment (M€2015 per MWh)	0.708	0.432	0.302	0.194	0.135	0.320	0.554	0.066	0.305	I	[44,48]	
- energy component (M€/MWh)	0.308	0.132	0.062	0.044	0.035	0.070	0.189	0.026	0.115	J	[44]	
- capacity component (M€/MW) PCS	0.29	0.27	0.16	0.1	0.06	0.24	0.51	0.04	0.25	K	[54–56]	
- other project costs (M€/MWh)	0.11	0.1	0.08	0.05	0.04	0.09	0.11	0.02	0.11	L	[22,40,54]	
Fixed O&M (k€2015/MW/year)	0.54	0.54	0.54	0.54	0.54	0.45	0.54	0.40	0.54	M	[22]	
Variable O&M (€2015/MWh)	2.1	2.0	1.8	1.7	1.6	0.4	5.6	0.3	2.5	N	[55]	
Technology specific data												
Energy storage expansion cost (M€2015/MWh)	0.418	0.232	0.142	0.094	0.075	0.16	0.259	0.046	0.176	O	[44,48]	
Output capacity expansion cost (M€2015/MW)	0.29	0.27	0.16	0.1	0.06	0.24	0.51	0.04	0.25	P	[54–56]	
Alternative Investment cost (M€2015/MW)	0.39	0.33	0.20	0.12	0.08	0.28	0.58	0.05	0.31	Q	[41,44,48,54–56]	
Lifetime in total number of cycles	6000	14000	30000	40000	50000	10000	16000	20000	70000	R	[3–5,14]	
Specific power (W/kg)	569	700	900	1000	1200	600	900	1000	2000	S	[2,24]	
Power density (kW/m ³)	708	800	1000	1200	1400	750	900	1200	2000	S	[2,24]	
Specific energy (Wh/kg)	95	105	139	174	209	100	140	150	300	S	[2,24]	
Energy density (kWh/m ³)	118	130	173	216	260	150	200	200	400	S	[2,24]	

** 1 € = 1.14 US\$

Data Sheet Notes:

- A. One unit defined as a 40 feet container including LIB system and excluding power conversion system. Values for 2015-2030 are taken from Samsung SDI brochures for grid-connected LIBs from 2016 and 2018 [2,14]. This unit of 3.2MWh/9.6MW (3C) is a typical size grid scale battery. The Specific investment cost under financial data is provided for a 1MWh : 1MW (1C) battery. Cost examples of a 2MWh/8MW and a 16MWh/4MW battery are given in the section below.
- B. Power input/output are set to 0.5/3 times the energy capacity as it is the standard grid-connected LIBs designed for power purposes [2,14]. It is noted that the power capacity is strongly dependent on the battery type and chemistry.
- C. The gradual change towards lower C-rates following the transition from frequency regulation to renewable integration promotes lower C-rates. Therefore the average DC roundtrip efficiency is expected to increase slightly. The RT eff. vs. C-rate is exemplified in Figure 7 [3,51]. The AC roundtrip efficiency includes losses in the power electronics and is 2-4% lower than the DC roundtrip efficiency. The total roundtrip efficiency further includes standby losses making the total roundtrip efficiency typically ranging between 80% and 90% [21,22].
- D. The C-rate is 0.5 during charge and up to 6 during discharge for the Samsung SDI batteries [2,14]. The presented conversion efficiencies assume average discharge C-rates in 2015-2020 around 3 and charge C-rates around 0.5.
- E. Lithium-ion battery daily discharge loss. The central estimates for self-discharge of Li-ion batteries range between 0.05% and 0.20% a day in 2016 and are expected to stay flat to 2030.
- F. It is expected not to have any outage during lifetime of the grid-connected LIB. Only a few days during the e.g. 15 years life time is needed for service and exchanging fans and blowers for thermal management system and power conversion system. Forced outage is expected to drop with increasing robustness following the learning rate and cumulated production. Planned outage is expected to decrease after 2020 due to increased automation.
- G. Current state-of-the-art NMC LIB has 20 years lifetime. The NMC lifetime is expected to reach LTO lifetime by 2020 and 30 years lifetime for grid-connected LIBs in 2040 and 2050 as photovoltaic power systems have today [3,5,8,14].
- H. The response time is obtained from simulated response time experiments with hardware in the loop [53].
- I. The system specific forecasts includes rack, TMS, BMS, EMS and PCS (Figure 5). The forecast is calculated as the sum of the PCS, the battery cell, and other costs. The system specific forecast is exclusive power cables to the site and entrepreneur work for installation of the containers [44,48]. The specific investment cost is the total cost of a 1MWh : 1MW (1C) battery. Cost examples of a 2MWh/8MW and a 16MWh/4MW battery are given in the section below.
- J. The battery pack cost forecast is provided in Figure 8 and the related text [44].
- K. Power conversion cost is strongly dependent on scalability and application. The PCS cost is based on references [54–56] and reflects the necessity for high power performance and compliance to grid codes to provide ancillary services, bidirectional electricity flow and two-stage conversion, as well as the early stage of development and the fact that few manufacturers can guarantee turnkey systems. Inverter replacement is expected every 10 years. The bidirectional inverter given here has more or less the same charge and discharge capacity (MW).
- L. Other costs include construction costs and entrepreneur work. These costs heavily dependent on location, substrate and site access. Power cables to the site and entrepreneur work for installation of the containers are included in other costs. Therefore other costs are assumed to – roughly – correlate with the system size. Automation is expected to decrease other costs from 2030 and onwards. Estimates are aggregated from the literature [22,40,54].
- M. Fixed O&M is assumed to be constant, although the O&M may depend on the application [22].
- N. Variable O&M is assumed to be 2.1 €/MWh in 2015 with a range of 0.4 – 5.6 [55].

- O. Since multi-MWh LIB systems are scalar, the energy storage expansion cost is here estimated to be equal to the energy component plus the “other costs” [44,48].
- P. Since multi-MW LIB systems are scalar, the capacity expansion cost equals the capacity component cost [54–56].
- Q. The alternative investment cost in M€2015/MW is specified for a 4C, 0.25 h system as for the Laurel Mountain, West Virginia, USA grid-scale LIB storage system [41]. I.e. the alternative investment cost is 25% of the energy storage expansion cost plus the PCS cost [41,44,48,54–56].
- R. Cycle life specified as the number of cycles at 1C/1C to 80% state-of-health. Samsung SDI 2016 whitepaper on ESS solutions provide 15 year lifetime for current modules operating at C/2 to 3C [14]. Steady improvement in battery lifetime due to better materials and battery management is expected. Kokam ESS solutions are also rated at more than 8000-20000 cycles (80-90% DOD) based on chemistry [3]. Thus for daily full charge-discharge cycles, the batteries are designed to last for 15-50 years if supporting units are well functioning. Lifetimes are given for both graphite and LTO anode based commercial batteries from Kokam. Cycle lives are steadily increasing over last few years as reflected in 2020/2030 numbers [4,5,14].
- S. Specific power, power density, Specific energy and energy density is provided for discharge mode, starting with the values provided in the section “Typical characteristics and capacities”. A charge/discharge conversion factor of 12 can be derived from this section. The expected development depends on the successive R&D progress as indicated in the section “Research and development perspectives” [2,24].

Frequency regulation and renewable energy integration cost examples

The aim with this technology catalogue is to provide a brief insight into the technical aspects, current status, and forecasted price level of the LIB BESS technology. In relation to this, and to help the reader obtaining realistic prices indications, we provide two simple installation cost calculation examples below. One for frequency regulation in 2020 and one for energy integration in 2030. The examples are based on the data in the Data sheet. For simplicity neither O&M expenses nor interest rates are included in the calculations.

Frequency regulation in 2020: 4C-rate, 2 MWh BESS system. 20 years operation time.

Cost items:

2 MWh “energy component”, year 2020

2 MWh “other project costs”, year 2020

8 MW PCS “capacity component” (10 years lifetime, i.e. one in year 2020 and one in year 2030)

$$\text{CAPEX: } 2 \cdot (0.132 \text{ M€} + 0.10 \text{ M€}) + 8 \cdot (0.27 \text{ M€} + 0.16 \text{ M€}) = 3.90 \text{ M€}$$

Energy integration in 2030: ¼C-rate, 16 MWh BESS system. 25 years operation time.

Cost items:

16 MWh “energy component”, year 2030

16 MWh “other project costs”, year 2030

4 MW PCS “capacity component” (10 years lifetime, i.e. one in year 2030 and one in year 2040. No extra PCS is assumed for the last 5 years)

$$\text{CAPEX: } 16 \cdot (0.132 \text{ M€} + 0.10 \text{ M€}) + 4 \cdot (0.16 \text{ M€} + 0.10 \text{ M€}) = 4,75 \text{ M€}$$

Acknowledgement

Arghya Bhowmik, DTU is acknowledged for inspiration via a previous draft of the technology.

References

- [1] Leclanche. Lithium Ion Technology and Product Description, (2018). <http://www.leclanche.com/technology-products/leclanche-technology/lithium-ion-cells/>
- [2] Samsung. ESS Batteries by Samsung SDI Top Safety & Reliability Solutions, (2018). http://www.samsungsdi.com/upload/ess_brochure/201809_SamsungSDI_ESS_EN.pdf
- [3] L. Kokam Co. Total Energy Storage Solution Provider, (2018). http://kokam.com/data/2018_Kokam_ESS_Brochure_ver_5.0.pdf
- [4] L. Kokam Co. Kokam Li-ion / Polymer Cell, (2017). http://kokam.com/data/Kokam_Cell_Brochure_V.4.pdf
- [5] StoraXe. StoraXe Industrial & Infrastructure Scalable battery storage system, (2018). https://www.ads-tec.de/fileadmin/download/doc/brochure/Datasheet_Energy_Industrial_EN.pdf
- [6] Fronius. Fronius Energy Package, (2018). <http://www.fronius.com/en/photovoltaics/products/all-products/solutions/fronius-storage-solution/fronius-energy-package/fronius-energy-package>
- [7] Fenecon. Fenecon Commercial 50-series Battery Module | Battery Rack, (2018). https://www.fenecon.de/en_US/page/infocenter#fenecon-industrial
- [8] Altairnano. 24 V 60 Ah Battery Module, (2016). <https://altairnano.com/products/battery-module/>
- [9] S. Weintraub, Electrek. Tesla Gigafactory tour roundup and tidbits: ‘This is the coolest factory in the world’, (2016). <https://electrek.co/2016/07/28/tesla-gigafactory-tour-roundup-and-tidbits-this-is-the-coolest-factory-ever/>
- [10] M. Kane, InsideEVs. BMW i3 Samsung SDI 94 Ah Battery Rated For 524,000 Miles, (2018). <https://insideevs.com/lets-look-at-the-specs-of-the-samsung-sdi-94-ah-battery/>
- [11] Qnovo. Inside the Battery of a Nissan Leaf, (2018). <https://qnovo.com/inside-the-battery-of-a-nissan-leaf/>

- [12] J.M. Tarascon, M. Armand. Issues and challenges facing rechargeable lithium batteries, *Nature*, **414** (2001) 359. doi:10.1038/35104644
- [13] Shutterstock. Tesla 2170 battery cell stock photos, (2018). <https://www.shutterstock.com/search/tesla+2170+battery+cell>
- [14] Samsung, Smart Battery Systems for Energy Storage, (2016). http://www.samsungsdi.com/upload/ess_brochure/Samsung SDI brochure_EN.pdf
- [15] Inside EVs. LCChem Prismatic Cell, (2018). https://insideevs.com/wp-content/uploads/2015/12/ess_cell1.jpg
- [16] H.C. Hesse, M. Schimpe, D. Kucevic, A. Jossen. Lithium-ion battery storage for the grid - A review of stationary battery storage system design tailored for applications in modern power grids, *Energies*, **10** (2017) 2107. doi:10.3390/en10122107
- [17] M. Schimpe, M. Naumann, N. Truong, H.C. Hesse, S. Santhanagopalan, A. Saxon, A. Jossen. Energy efficiency evaluation of a stationary lithium-ion battery container storage system via electro-thermal modeling and detailed component analysis, *Appl. Energy*. **210** (2018) 211. doi:10.1016/j.apenenergy.2017.10.129
- [18] Electropaedia. Battery Performance Characteristics - How to specify and test a battery, (2018). <https://www.mpoweruk.com/performance.htm>
- [19] L. Kokam Co. Lithium Ion Polymer Cells - High Energy High Power | Kokam Battery Cells, (2018). <http://kokam.com/cell/>
- [20] Sempra Renewables. Auwahi Wind, (2012). <http://www.semprarenewables.com/project/auwahi-wind/>
- [21] A.H. Fathima, K. Palanisamy. Renewable systems and energy storages for hybrid systems, Ed(s): A. Hina Fathima, *et al.*, in *Hybrid-renewable energy systems in microgrids*. Woodhead Publishing (2018), pp. 162. <https://doi.org/10.1016/B978-0-08-102493-5.00008-X>
- [22] Lazard. Levelized Cost of Storage (2017)., <https://www.lazard.com/perspective/levelized-cost-of-storage-2017/>
- [23] R. Hidalgo-León *et al.* A survey of battery energy storage system (BESS), applications and environmental impacts in power systems, 2017 IEEE 2nd ETCM pp. 1–6. doi:10.1109/etcm.2017.8247485.
- [24] LG Chem. Change your energy. Change your life., (2018). http://www.lgchem.com/upload/file/product/LGChem_Catalog_Global_2018.pdf
- [25] Researchinterfaces. Lithium-ion batteries for large-scale grid energy storage, (2018). <https://researchinterfaces.com/lithium-ion-batteries-grid-energy-storage/>
- [26] U.S. EPA. Application of Life-Cycle Assessment to Nanoscale Technology: Lithium-ion

- Batteries for Electric Vehicles, United States Environ. Prot. Agency. (2013) 1–119. doi:10.1038/nchem.2085.
- [27] J.F. Peters, M. Baumann, B. Zimmermann, J. Braun, M. Weil. The environmental impact of Li-Ion batteries and the role of key parameters – A review, *Renew. Sustain. Energy Rev.* **67** (2017) 491–506. doi:10.1016/j.rser.2016.08.039
- [28] The Washington Post. The environmental impact of cobalt mining, (2018). https://www.washingtonpost.com/news/in-sight/wp/2018/02/28/the-cost-of-cobalt/?utm_term=.eebc6c00f0de
- [29] Visualcapitalist. Nickel: The Secret Driver of the Battery Revolution, (2017). <http://www.visualcapitalist.com/nickel-secret-driver-battery-revolution/>
- [30] Bloomberg. We're Going to Need More Lithium, (2017). <https://www.bloomberg.com/graphics/2017-lithium-battery-future/>
- [31] R. Petibon, J. Xia, L. Ma, M.K.G. Bauer, K.J. Nelson, J.R. Dahn. Electrolyte System for High Voltage Li-Ion Cells, *J. Electrochem. Soc.* **163** (2016) A2571–A2578. doi:10.1149/2.0321613jes
- [32] A. Casimir, H. Zhang, O. Ogoke, J.C. Amine, J. Lu, G. Wu. Silicon-based anodes for lithium-ion batteries: Effectiveness of materials synthesis and electrode preparation, *Nano Energy.* **27** (2016) 359–376. doi:10.1016/j.nanoen.2016.07.023
- [33] M. Saulnier, A. Auclair, G. Liang, S.B. Schougaard. Manganese dissolution in lithium-ion positive electrode materials, *Solid State Ionics.* **294** (2016) 1–5. doi:10.1016/j.ssi.2016.06.007
- [34] E.-Y. Kim, B.-R. Lee, G. Yun, E.-S. Oh, H. Lee. Effects of binder content on manganese dissolution and electrochemical performances of spinel lithium manganese oxide cathodes for lithium ion batteries, *Curr. Appl. Phys.* **15** (2015) 429–434. doi:10.1016/j.cap.2015.01.029
- [35] S. Lee, E.-Y. Kim, H. Lee, E.-S. Oh. Effects of polymeric binders on electrochemical performances of spinel lithium manganese oxide cathodes in lithium ion batteries, *J. Power Sources.* **269** (2014) 418–423. doi:10.1016/j.jpowsour.2014.06.167
- [36] eeNews Power Management. Revolutionary solid state rechargeable aluminium-sulfur battery project starts, (2017). <http://www.eenewspower.com/news/revolutionary-solid-state-rechargeable-aluminium-sulfur-battery-project-starts>
- [37] Ørsted. Ørsted takes first steps into commercial energy storage, (2018). <https://orsted.com/en/Media/Newsroom/News/2018/04/Orsted-takes-first-steps-into-commercial-battery-storage>
- [38] Tesla. Addressing Peak Energy Demand with the Tesla Powerpack, (2016). https://www.tesla.com/da_DK/blog/addressing-peak-energy-demand-tesla-powerpack?redirect=no
- [39] Electrek. Tesla quietly brings online its massive - biggest in the world - 80 MWh Powerpack

station with Southern California Edison, (2017). <https://electrek.co/2017/01/23/tesla-mira-loma-powerpack-station-southern-california-edison/>

- [40] Tesla. Tesla Powerpack to Enable Large Scale Sustainable Energy to South Australia, (2017). https://www.tesla.com/da_DK/blog/Tesla-powerpack-enable-large-scale-sustainable-energy-south-australia?redirect=no Page
- [41] Energy Storage Association. Frequency Regulation Services and a Firm Wind Product: AES Energy Storage Laurel Mountain Battery Energy Storage, (2018). <http://energystorage.org/energy-storage/case-studies/frequency-regulation-services-and-firm-wind-product-aes-energy-storage>
- [42] ABB. Battery energy storage system PQpluS, (2018). <https://new.abb.com/high-voltage/capacitors/lv/bess-products/PQpluS>
- [43] S. Saylor, Philip C. Kjær. Rasmus Lærke. Ancillary Services Provided from Wind Power Plant Augmented with Energy Storage, (2014). <https://www.ieee-pes.org/presentations/gm2014/PESGM2014P-000718.pdf>
- [44] Bloomberg New Energy Finance. New Energy Outlook 2018, (2018). <https://bnef.turl.co/story/neo2018.pdf?autoprint=true&teaser=true>
- [45] CleanTechnica. \$100/kWh Tesla Battery Cells This Year, \$100/kWh Tesla Battery Packs In 2020, (2018). <https://cleantechnica.com/2018/06/09/100-kwh-tesla-battery-cells-this-year-100-kwh-tesla-battery-packs-in-2020/>
- [46] Wardsauto. Two Tidbits From CES: Better Cybersecurity and Cheaper EV Batteries, (2017). <https://www.wardsauto.com/ideaxchange/two-tidbits-ces>
- [47] Visualcapitalist. China Leading the Charge for Lithium-Ion Megafactories, (2017) <http://www.visualcapitalist.com/china-leading-charge-lithium-ion-megafactories/>
- [48] International Renewable Energy Agency. IRENA Battery Storage Report, (2015). http://www.irena.org/-/media/Files/IRENA/Agency/Publication/2015/IRENA_Battery_Storage_report_2015.pdf
- [49] Windpower Engineering & Development. Global battery energy-storage system installed capacity will exceed 14 GW by 2020, (2016). <https://www.windpowerengineering.com/business-news-projects/global-battery-energy-storage-system-installed-capacity-will-exceed-14-gw-2020/>
- [50] International Renewable Energy Agency. Electricity Storage and Renewables: Costs and Markets To 2030, (2017). <http://www.irena.org/publications/2017/Oct/Electricity-storage-and-renewables-costs-and-markets>
- [51] Danish Technological Institute. BESS project Smart grid ready Battery Energy Storage System for future grid, (2017). https://www.energiforskning.dk/sites/energiteknologi.dk/files/slutrappporter/bess_final_report_forskel_10731.pdf

- [52] H. Chen, T.N. Cong, W. Yang, C. Tan, Y. Li, Y. Ding, Progress in electrical energy storage system: A critical review, *Prog. Nat. Sci.* **19** (2009) 291–312. doi:10.1016/j.pnsc.2008.07.014
- [53] D.M. Greenwood, K.Y. Lim, C. Patsios, P.F. Lyons, Y.S. Lim, P.C. Taylor, Frequency response services designed for energy storage, *Appl. Energy*. **203** (2017) 115–127. doi:10.1016/j.apenergy.2017.06.046
- [54] R. Benato, G. Bruno, F. Palone, R.M. Polito, M. Rebolini, Large-scale electrochemical energy storage in high voltage grids: Overview of the Italian experience, *Energies*. **10** (2017) 1-17. doi:10.3390/en10010108
- [55] B. Zakeri, S. Syri, Electrical energy storage systems: A comparative life cycle cost analysis, *Renew. Sustain. Energy Rev.* **42** (2015) 569–596. doi:10.1016/j.rser.2014.10.011
- [56] G. Huff, A.B. Currier, B.C. Kaun, D.M. Rastler, S.B. Chen, D.T. Bradshaw, W.D. Gauntlett, DOE/EPRI electricity storage handbook in collaboration with NRECA, (2015). <https://www.sandia.gov/ess-ssl/publications/SAND2015-1002.pdf>

181 VANADIUM REDOX FLOW BATTERY

Contact information

Danish Energy Agency: Thomas Mandal Østergaard , tmo@ens.dk

Energinet.dk: Rune Duban Grandal, rdg@energinet.dk

Author: Rune Christensen (runch@dtu.dk), DTU Energy

Publication date

December 2018

Amendments after publication date

Date	Ref.	Description

Brief technology description

Vanadium redox flow batteries also known simply as Vanadium Redox Batteries (VRB) are secondary (i.e. rechargeable) batteries. VRB are applicable at grid scale and local user level. Focus is here on grid scale applications.

VRB are the most common flow batteries. A flow battery consists of a reaction cell stack, where the electrochemical reactions occur, at least one storage tank filled with electrolyte (anolyte) consisting of reactants in solution for the negative battery electrode, i.e., the anode, at least one storage tank filled with electrolyte (catholyte) consisting of reactants in solution for the positive battery electrode, i.e., the cathode, piping connecting the storage tanks with the reaction cell stack, and mechanical pumps to circulate the electrolytes in the system. A schematic of a traditional flow battery can be seen in Figure 1. The region bordered by the grey electrodes is the reaction cell stack.

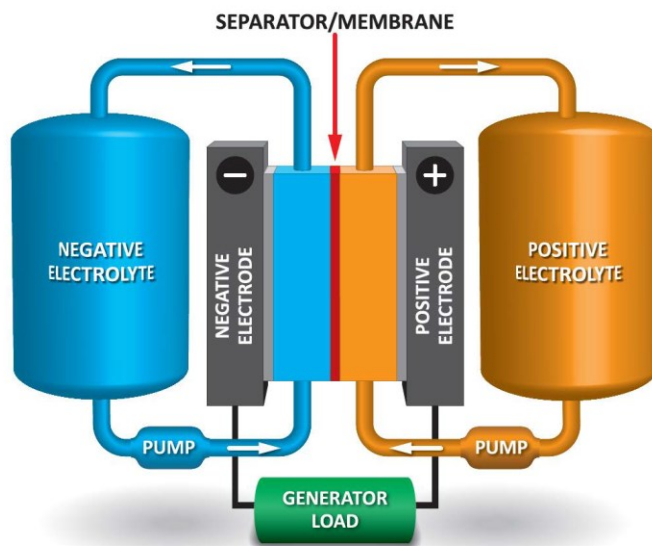

Figure 1: Schematic of flow battery [1].

The anolyte reactive species are V^{2+} and V^{3+} ions. The catholyte reactive species are VO_2^+ and VO^{2+} ions with the V atom in oxidation state +5 and +4, respectively. Traditionally, the reactive species have been dissolved with concentrations of 1.5 - 2 M in aqueous sulfuric acid solutions with an acid concentration of 2-5 M [2].

When pumped into the reaction cell the anolyte and catholyte will be separated by a proton conducting (polymer) membrane. An illustration of reaction cell components and a full reaction stack can be seen in Figure 2.

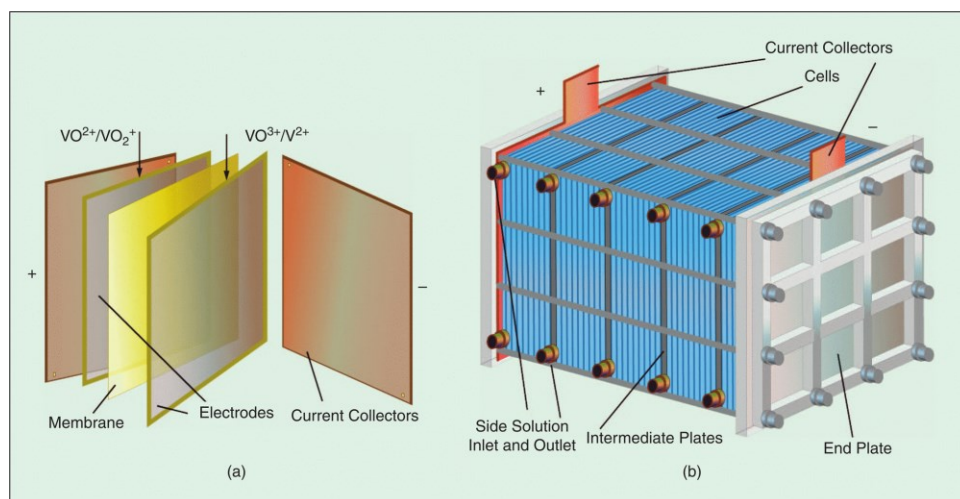
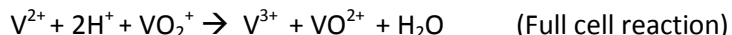

Figure 2: a) Reaction cell. b) Typical stack [2].

During discharge the following reaction occurs in the cell as two protons pass through the membrane and an electron pass through an external circuit.



During charge the reverse reaction occurs. The full reaction provides a cell voltage of 1.26 V. The battery operates at ambient temperatures.

Flow batteries are different from other batteries by having physically separated storage and power units. The volume of liquid electrolyte in storage tanks dictates the total battery energy storage capacity while the size and number of the reaction cell stacks dictate the battery power capacity. The energy storage capacity and power capacity can thus be varied independently according to desired application and customer demand [2].

A VRB installation consists, as a minimum, of a VRB unit as described above, a battery management system, and a power conversion system connecting the battery unit to the grid. For a more detailed technology description the reader is referred to “Encyclopedia of Electrochemical Power Sources” [3].

Input/output

Primary input and output are both electricity. Electricity is converted to electrochemical energy during charge and converted back to electricity during discharge in the reaction process described above.

Energy efficiency and losses

Electrolyte left in the cell stack during idle periods will self-discharge over time resulting in an energy loss. As the electrolyte volume in the cell stack is generally small compared to the total electrolyte volume, the total energy loss from self-discharge will be at most 2 % of stored energy during any idle period [4]. The mechanical pumps require energy. The energy used by the mechanical pumps is included in determination of battery efficiency and should thus not be treated as a separate loss.

For individual VRB reaction cells the energy conversion efficiency can be as large as 90 % at low current densities [3]. The grid-to-grid efficiency is reported by multiple sources to be approximately 70 % at constant rated discharge power [1], [4], [5]. UniEnergy Technologies reports 75 % energy efficiency for frequency regulation application and 70 % energy efficiency for peak shaving application [6]. Vionx Energy reports a DC efficiency of 78 % and an AC efficiency of 68 % for their units operating at rated capacity [5].

Regulation ability and other system services

The response time (i.e. the time it takes for the battery to supply a requested charge or discharge power) is according to manufactures < 100 ms if electrolyte is already present in the reaction cell [4], < 1 s if electrolyte must first be pumped into the cell [5], and < 1 min if the pumps are turned off [5]. Large scale VRB installations have been demonstrated to be routinely capable of operating for 30 s at 150 % rated power capacity [7].

Grid scale battery operation depends on the application. Batteries used for time shifting will generally complete a single charge/discharge cycle over 24 hours. Batteries used for various other grid services including stabilization of input from renewables as exemplified below will often not undergo traditional battery cycling but frequently switch between being charged and discharged according to demand.

Due to its short response time combined with the ability to independently vary installation size of energy storage capacity and power capacity, VRB installations can provide a range of system services. The manufacturer UniEnergy Technologies lists the following applications for grid and utility installations: T&D deferral (avoid need to upgrade transmission and distribution equipment), flex capacity/ramping, load shifting, and ancillary services [6].

Typical characteristics and capacities

Examples of recently commissioned grid-scale VRB installations are listed Table 1.

Location	Yokohama, Japan	Hokkaido, Japan	Braderup, Germany	Pullman, Washington, USA
Commissioning year	2012	2016	2014	2015
Energy Storage Capacity	5 MWh	60 MWh	1 MWh	4 MWh
Power Capacity	1 MW	15 MW	325 kW	1 MW
Technology provider	Sumitomo Electric Industries	Sumitomo Electric Industries	UniEnergy Technologies	UniEnergy Technologies

Table 1: Selected grid-scale VRB installations [6], [8], [9].

The non-exhaustive DOE Global Energy Storage Database [1], [9] lists 21 different installations of at least 100 kW commissioned since 2011. The 21 installations have been supplied by at least 8 different manufactures. A 200 MW/800 MWh installation is currently under construction in Dalian in China [9].

The energy density and specific energy for two selected commercial units are shown in Table 2.

Manufacturer	Energy density (Wh/m³)	Specific energy (Wh/kg)
UniEnergy Technologies	9040	11.8
Sumitomo Electric Industries	5880	7.1

Table 2: Energy density and Specific energy for commercial VRB units [4], [10].

Typical storage period

The typical storage period depends on operation. It ranges from minutes to hours for grid scale installations [11]. The storage time is not technologically limited. Energy can be stored for extended periods of time as is the case in small local user level VRB units used for emergency power.

Space Requirement

The installation in Hokkaido, Japan (Table 1) commissioned in 2016 occupy a total land area of 5000 m² [12]. This corresponds to a land use of 83.3 m²/MWh.

UniEnergy Technologies have in promotional material suggested that an installation with 240 MWh storage capacity would occupy a land area of 4000 m² [6]. This corresponds to a land use of 16.7 m²/MWh. This is the lowest value found.

The largest land usage found for current commercially available grid scale VRB units is 140.2 m²/MWh [10].

Advantages/disadvantages

General advantages and disadvantages of batteries in comparison to other technologies for energy storage are listed in Table 4.

Advantages	Disadvantages
Short response time	
Flexible installation size	Relatively short lifetime ¹³
High energy efficiency	
Versatile application	Large investment cost
Relatively compact	
Low maintenance	

Table 4: General advantages and disadvantages of batteries in comparison to other technologies for energy storage

In comparison to other grid-scale batteries, VRB and other flow batteries have the significant advantage that the energy storage capacity and power capacity can be varied independently and optimized for a specific application. In contrast to molten sodium batteries (Na-S and Na-NiCl₂) also applicable for grid scale applications, VRB operate at ambient temperatures. The reactants in a VRB are in a solution. This allows the full energy storage capacity of the battery to be utilized without battery degradation in contrast to batteries where charge/discharge products are solid state [1]. VRB have long technical lifetime in comparison to other batteries. Current batteries are reported by multiple manufactures to have unlimited cycle lifetime within the technical lifetime (up to 20 years). Due to the large technical and cycle lifetime compared to other batteries, VRB have the lowest levelized cost of storage (€/kWh per cycle) among grid scale batteries [2]. VRB also have the advantage that the electrolytes can easily be recycled and reused [1]. As vanadium is the active specie in both anolyte and catholyte, leakage of reactants from one electrolyte into the storage container of the other electrolyte will, in contrast to other flow batteries, not result in electrolyte contamination but only loss of energy storage capacity. The energy storage capacity can be regained by re-balancing the volume and vanadium content of the two electrolyte solutions [1]. VRB are by manufactures promoted as being very safe [6].

VRB and other flow batteries have relatively low grid-to-grid energy efficiencies in comparison to other batteries. This is a consequence of losses related to mechanical pumping of electrolyte, undesired electrical currents known as shunt currents, which allows electrons to bypass the external circuit, and leakage of reactant vanadium ions through the reaction cell membrane. Even though the energy density and specific energy for VRB have recently increased, they remain relatively low in comparison to other batteries [1], [13]. The cost of

¹³ Although some batteries have lifetimes as long as 20 years (VRB), battery lifetimes in general are shorter than that of PHS (60 years) and CAES (50 years) [28].

vanadium has historically been high and have recently increased by approximately 50 % [14], [15]. The raw material cost of vanadium has previously been estimated to contribute \$140/kWh to the battery cost, which corresponds to approximately 20 % of the total investment costs for a VRB installation [16]. The absolute minimum energy storage capacity cost of VRB with the currently used reaction chemistry is approximately 70 \$/kWh, assuming a cost of V_2O_5 at 6 \$/lb [17] is used as source of vanadium [18]. The future cost of vanadium might be higher. Currently, demand exceeds supply and prices have increased to approximately 9 \$/lb for V_2O_5 [14], [15].

R&D can and has previously allowed lower-cost sources of vanadium to be used as raw material [1]. The vanadium reactants have the potential to corrode the membrane. High quality and large cost membranes must thus be used in VRB reaction cells [1], [13]. Alternatively, the membrane must be replaced within the technical lifetime of the battery.

Environment

The active reactants in VRB are vanadium ions. Besides being relatively expensive, vanadium might also pose environmental risk factors, which are yet to be fully determined [19]. Most VRB components can be recycled [1]. The vanadium electrolyte is if possible directly reused. Otherwise the vanadium is extracted before further disposal or recycling [1]. Some of the initial investment into raw material vanadium might be regained in this process. The cell membranes might be highly acidic or alkaline after end of battery life and should thus be treated as corrosive material during recycling or disposal [19].

Research and development perspectives

VRB are under rapid development. There is significant potential for R&D to reduce cost of all battery components [20], [21]. An example is research in use of non-aqueous electrolytes [2]. The minimum cost will, however, likely be limited by the vanadium cost. The vanadium cost is not fixed in the sense that there is a potential for use of lower cost vanadium sources in production than those traditionally used [1].

There is a significant potential for cost reduction of flow batteries by using alternative reaction chemistries, i.e., other redox couples than vanadium [21]. Grid scale redox flow batteries could potentially be based on, e.g., zinc-bromide, bromide-polysulphide, iron-chromium, and zinc-chloride [21].

Examples of market standard technology

Grid scale turn-key VRB installations are commercially available from several currently operating manufactures as shown in the non-exhaustive list in Table 5. The market appears volatile with VRB manufactures frequently entering the market or ceasing to operate.

Manufacturer	Website
Gildemeister Energy Solutions	http://www.energy.gildemeister.com/en
REDTEnergy	http://www.redtenergy.com
Rongke Power	http://www.Rongkepower.com
Sumitomo Electric Industries	http://global-sei.com/
UniEnergy Technologies	http://www.uetechnologies.com/
Vionx Energy	http://www.Vionxenergy.com

Table 5: Some currently operating VRB manufactures.

The Danish company VisBlue (<http://www.visblue.com>) provides VRB installations marketed for local users of up to 100kW/500kWh in size.

Two examples of standard units are presented below. Performance data for the Uni.System unit manufactured by UniEnergy Technologies is listed in Figure 3. A Uni.System unit consists of 5 standard 20 foot containers [6]. Data for VNX1000 type units with variable energy storage capacity is listed in Figure 4.

UNI.SYSTEM™ (AC) PERFORMANCE DATA

Peak Power	600 kW _{AC}		
Maximum Energy	2.2 MWh _{AC}		
Discharge time	2h	4h	8h
Power	600 kW _{AC}	500 kW _{AC}	275 kW _{AC}
AC (Roundtrip) Efficiency	≈70%		
Voltage	12.47kV +/- 10%		
Current THD (IEEE 519)	<5%THD		
Response Time	<100ms		
Reactive Power	+/- 450kVAR		
Humidity	95%RH noncondensing		
Footprint	820 ft ² (76m ²)		
Envelope	41'[W] x 20'[D] x 9.5'[H] (12.5m[W]x6.1m[D]x2.9m[H])		
Total Weight	375,000 lbs (170,000 kg)		
Cycle and Design Life	Unlimited cycles over the 20 year life		
Ambient Temp.	-40°F to 122°F (-40°C to 50°C)		
Self Discharge	Max 2% of stored energy		

Figure 3: Performance data for Uni.System unit [4].



ENERGY STORAGE MODULE	VNX1000-6	VNX1000-8	VNX1000-10
Energy Storage (MWh)	6 MWh	8 MWh	10 MWh
Usable Depth of Discharge	100%	100%	100%
Life	20 years (unlimited cycles)		
Power Rating	1 MW AC [2 Stack Containers]		
DC Footprint	185 m ² / 2,000ft ²	195 m ² / 2,100ft ²	205 m ² / 2,200ft ²
DC Efficiency (stack)	78%	78%	78%
DC Voltage	500V–800V DC operating range		
AC Efficiency	68%	68%	68%
Signal Response	<1 Second electrolyte pumps ON <1 Minute electrolyte pumps OFF		
Interconnection Standard	IEEE 1547		
Operating Ambient Temperature	-40°C to +45°C / -40°F to 113°F		
Relative Humidity	0 to 100%		

Figure 4: Data for various VRB configurations from Vionx [5].

Prediction of performance and cost

Data for 2015

The balance between power capacity and energy storage capacity in battery installations, which for flow batteries at least in principle can be adjusted according to customer demand, will influence the “energy component” cost, as it is defined here. The ratio can be quantified through the discharge time at rated power, h . The cost of the battery including electrolyte storage and reaction stack per MWh, i.e., the energy component in the data sheet below, is given by

$$C_E = C_{elec} + C_{stack} / h$$

where C_{elec} is the cost of electrolyte and storage tanks and C_{stack} is the cost of the reaction stack and other parts of the system including pumps. According to IRENA [22], $C_{elec} = 347 \text{ €2016/kWh}$ and $C_{stack} = 1313 \text{ €2016/kW}$. A similar reaction stack cost has previously been found [23]. Thus

$$C_E = 347 \text{ €/kWh} + 1313 \text{ €/kW} / h$$

O&M costs are obtained from Carlsson et al. [24] (assumed similar to 2013 values), and Zakeri and Syri [25].

Previously, the membrane in the reaction stack has required replacement after approximately 8 years of use [26]. This does, however, not appear to be the case in all currently available technological designs [6].

Assumptions for the period 2020 to 2050

Estimates for 2020 and 2030 in the data sheet below are based on data from IRENA [22], [27], [28]. Values in USD have been converted to € using an exchange rate of 0.86.

As discussed in the Chapter Electricity Storage, the current PCS cost including grid connection is 0.4-0,5 M€/MW. This is used as reference value for the “capacity component”. The inverter costs, which account for approximately 50 % of cost [19], [25], [29], is predicted to decrease by 20 % in 2020 and 50 % in 2030 [22], [27]. The other 50 % of cost is assumed constant. Cost reductions of capacity components is assumed to not occur beyond 2030.

2050 financial figures predicted from learning curves have previously found cost reductions of 7.5 % from the period 2030 to 2050 for the cost per power capacity [30]. Although power and energy storage capacity will likely not follow identical development in cost, the 7.5 % cost reduction is assumed to apply to both. This neglects the possibility that the raw material cost of vanadium might increase.

“Other project costs” is assumed to be 8 % of CAPEX (here “Specific investment”), as per data from EPRI [19].

O&M costs are assumed to be constant in the given units.

No development in calendar lifetime, and efficiency is assumed to take place beyond 2030. The regulatory ability is assumed to not improve.

Learning curves and technological maturity

The level of maturity for grid scale VRB is early “Category 3: Commercial technologies with moderate deployment”. Based on the current commercial situation with large market volatility it is difficult to establish general learning curves based on past installations. It has been attempted [18]. The reported uncertainties are, however, of a magnitude making the predicted price range 120-1,160 US\$/kWh by 2040. The approach of IRENA [22], [27], [28] is thus preferred for predictions.

Uncertainty

Uncertainties for 2020 and 2030 are when possible obtained from IRENA [22], [28]. Uncertainties in 2050 are assumed to be percentagewise similar to those in 2030. For the “capacity component” the maximum values for PCS cost found by Zakeri and Syri [25] are used as baseline. The uncertainties are calculated for future years by keeping the relative uncertainty compared to the cost prediction constant.

The uncertainties for O&M costs are determined using the literature review by Zakeri and Syri [25]. The uncertainties are calculated from the expected value using the relative difference between the extrema and the average in the literature review. Uncertainties are in general large.

Additional remarks

Since battery units are highly modular and equipment is the main cost of full installations, a close to linear scaling in total cost vs. installation size is expected from a technological point of view. Significant financial benefits from increasing installation sizes will rely on negotiations with manufacturers.

Even though VRB and other flow batteries have high commercial potential, rapid cost reduction of alternative storage solutions, e.g., Li-ion batteries might halter commercial deployment and technological development of VRB and other flow batteries. This can prevent VRB and other flow batteries from reaching full commercial potential

Quantitative description

Technology	Vanadium Redox Battery (VRB)									
	2015	2020	2030	2050	Uncertainty (2020)		Uncertainty (2050)		Note	Ref
Energy/technical data	Lower		Upper		Lower		Upper			
Form of energy stored	Electricity									
Application	System, power- and energy-intensive									
Energy storage capacity for one unit (MWh)	2.0	2.0	2.0	2.0	0.4	800	0.4	800	A,M	[4]+[9]
Output capacity for one unit (MW)	0.5	0.5	0.5	0.5	0.1	200	0.1	200	A,M	[4]
Input capacity for one unit (MW)	0.5	0.5	0.5	0.5	0.1	200	0.1	200	A,M	[4]
Round trip efficiency - DC (%)	78	78	78	78	62	88	67	95	B	[5];[22]
- Charge efficiency (%)	-	-	-	-	-	-	-	-		
- Discharge efficiency (%)	-	-	-	-	-	-	-	-		
Energy losses during storage (%/day)	0	0	0	0	0	0.2	0	0.2	C	[4];[22]
Forced outage (%)	0.5	0.5	0.5	0.5	0	5	0	5	D,M	[1]
Planned outage (weeks per year)	0	0	0	0	0	0	0	0	D,M	[1]
Technical lifetime (years)	20	20	20	20	6	23	8	32		[4];[28]+[22]
Construction time (years)	1	1	1	1	0.2	2	0.2	2	E,M	[9]
Regulation ability										
Response time from idle to full-rated discharge (sec)	0.1	0.1	0.1	0.1	0.005	2	0.005	2	F,G	[4]+[30]
Response time from full-rated charge to full-rated discharge (sec)	0.07	0.07	0.07	0.07	0.004	1.4	0.004	1.4	F,G,M	[1]
Financial data										
Specific investment (M€2015 per MWh)	0.75	0.60	0.35	0.33	0.53	1.15	0.30	0.58	H	[22]+[27]/[19]
- energy component (M€/MWh)	0.58	0.45	0.24	0.22	0.38	0.94	0.19	0.44	H, I	[22]+[27]
- capacity component (M€/MW)	0.45	0.41	0.33	0.33	0.43	0.48	0.35	0.39	H	[22]+[25]+[27]/[19]
- other project costs (M€/MWh)	0.06	0.05	0.03	0.03	0.04	0.09	0.02	0.05	J	[19]
Fixed O&M (% total investment)	2.0	2.0	1.5	1.5	0.8	4.1	0.6	3.1		[24]+[25]/[2]
Variable O&M (€2015/MWh)	0.9	0.9	0.9	0.9	0.2	2.8	0.2	2.8		[25]/[2]
Technology specific data										
Alternative Investment cost (M€2015/MW)	3.0	2.4	1.4	1.3	2.1	4.6	1.2	2.3	H	[22]+[31]+[27]/[19]
Lifetime in total number of cycles	-	-	-	-	-	-	-	-	K	[1]
Specific power (W/kg)	2.9	2.9	2.9	2.9	1.45	3.63	1.45	3.63	A,L,M	[4]
Power density (W/m ³)	2260	2260	2260	2260	1130	2825	1130	2825	A,L,M	[4]
Specific energy (Wh/kg)	11.8	11.8	11.8	11.8	5.90	14.75	5.90	14.75	A,L,M	[4]
Energy density (Wh/m ³)	9040	9040	9040	9040	4520	11300	4520	11300	A,L,M	[4]

Notes:

- A One Uni.System unit from UniEnergy Technologies. Installation sizes vary from tens of kW to hundreds of MW.
- B Efficiency varies depending on use.
- C Energy losses depend on idle situation. If pumps are off and electrolyte not present in the reaction stack no energy loss occurs. This increases response time (see above). Self-discharge only occurs for electrolyte inside the reaction stack. This is a relatively small volume and the self-discharge will be at most 2 % over time for typical installations. Losses related to stand-by energy consumption of pumps are not included.
- D Some companies guarantee at least 99.5% uptime.
- E Depends highly on the installation.
- F Time is less than 100 ms for idle situation with electrolyte in reaction stack and pumps on [4]. Less the 1 s if electrolyte must first be pumped [5]. Less than 1 min if pumps are not on [5]. PCS might be limiting the response time.
- G Might in practice be limited by PCS.
- H Valid for installations with rated discharge times of 4 hours. Use equation in "Prediction of performance and cost" above to calculate for installations with a different rated discharge time.
- I Composed of both electrolyte etc. at 347 €/kWh and stack at 1313 €/kW [22].
- J Value for utility T&D installations with discharge time of 4 hours used.
- K Manufactures state unlimited number of cycles during technical lifetime [4], [5].
- L Varies with capacity to storage ratio. Is significantly lower for some manufactures.
- M Uncertainties are based on a qualified guess.

References

- [1] M. Manahan, N. Jewell, D. Link, and B. Westlake, "Program on Technology Innovation: Assessment of Flow Battery Technologies for Stationary Applications," *EPRI*, 2016.
- [2] M. Guarnieri, P. Mattavelli, G. Petrone, and G. Spagnuolo, "Vanadium Redox Flow Batteries: Potentials and Challenges of an Emerging Storage Technology," *IEEE Ind. Electron. Mag.*, vol. 10, no. 4, pp. 20–31, 2016.
- [3] M. Skyllas-Kazacos, "SECONDARY BATTERIES – FLOW SYSTEMS | Vanadium Redox-Flow Batteries," in *Encyclopedia of Electrochemical Power Sources*, 2009, pp. 444–453.
- [4] UniEnergy Technologies, "Uni.System product data," 2016.
- [5] Vionx Energy, "VNX 1000 SERIES Product data," 2017.
- [6] UniEnergy Technologies, *Product material: Maximizing Value Thorough UET Energy Storage*. 2015.
- [7] Z. Yang *et al.*, "Electrochemical Energy Storage for Green Grid," *Chem. Rev.*, vol. 111, no. 5, pp. 3577–3613, May 2011.
- [8] Sumitomo Electric Group, *REDOX FLOW BATTERY: Product material*. 2016.
- [9] "DOE Global Energy Storage Database." [Online]. Available: <https://www.energystorageexchange.org/>. [Accessed: 29-Mar-2017].
- [10] Sumitomo Electric Group, "Container Type Redox Flow Battery System," 2017.
- [11] IEC, "Electrical Energy Storage," 2011.
- [12] "Sumitomo Electric Industries, Ltd. | Press Release (2013) Selected to be Subsidized by the Governmental Program for Urgent Demonstration Project of Large-scale Energy Storage Systems." [Online]. Available: http://global-sei.com/news/press/13/prs088_s.html. [Accessed: 30-Mar-2017].
- [13] J. Cho, S. Jeong, and Y. Kim, "Commercial and research battery technologies for electrical energy storage applications," *Prog. Energy Combust. Sci.*, vol. 48, pp. 84–101, Jun. 2015.
- [14] T. Biesheuvel and M. Burton, "It's Boom Time for Vanadium, Ruthenium and Cobalt - Bloomberg," *Bloomberg Markets*, 2017. [Online]. Available: <https://www.bloomberg.com/news/articles/2017-08-23/obscure-metal-used-to-fight-crusaders-has-surged-67-in-a-month>. [Accessed: 06-Dec-2017].
- [15] C. K. Charlotte Radford, Anna Xu, "GLOBAL VANADIUM WRAP: Prices rise across the board amid tight supply of V2O5 | Metal Bulletin.com," 2017. [Online]. Available: <https://www.metalbulletin.com/Article/3768052/GLOBAL-VANADIUM-WRAP-Prices-rise-across-the-board-amid-tight-supply-of-V2O5.html>. [Accessed: 18-Dec-2017].
- [16] M. Moore, R. Counce, J. Watson, and T. Zawodzinski, "A Comparison of the Capital Costs of a Vanadium Redox-Flow Battery and a Regenerative Hydrogen-Vanadium Fuel Cell," *J. Adv. Chem. Eng.*, vol. 5, no. 4, pp. 5–7, 2015.
- [17] M. C. S. U.S. Geological Survey, "VANADIUM (Data in metric tons of vanadium content unless otherwise

noted),” 2014.

- [18] O. Schmidt, A. Hawkes, A. Gambhir, and I. Staffell, “The future cost of electrical energy storage based on experience rates,” *Nat. Energy*, vol. 2, no. 8, p. 17110, Jul. 2017.
- [19] G. Huff *et al.*, “DOE/EPRI 2013 electricity storage handbook in collaboration with NRECA,” *Rep. SAND2013- ...*, no. July, p. 340, 2013.
- [20] L. Baumann and E. Boggasch, “Experimental assessment of hydrogen systems and vanadium-redox-flow-batteries for increasing the self-consumption of photovoltaic energy in buildings,” *Int. J. Hydrogen Energy*, vol. 41, no. 2, pp. 740–751, 2016.
- [21] O. Teller *et al.*, “Joint EASE/EERA Recommendations for a European Energy Storage Technology Development Roadmap Towards 2030,” 2013.
- [22] IRENA, “Electricity storage and renewables: Costs and markets to 2030 - Cost-of-service tool. Version 1.0,” 2017.
- [23] G. Kear, A. A. Shah, and F. C. Walsh, “Development of the all-vanadium redox flow battery for energy storage: a review of technological, financial and policy aspects,” *Int. J. Energy Res.*, vol. 36, no. 11, pp. 1105–1120, Sep. 2012.
- [24] J. E. Al Carlsson, “ETRI 2014 - Energy Technology Reference Indicator projections for 2010-2050,” 2014.
- [25] B. Zakeri and S. Syri, “Electrical energy storage systems: A comparative life cycle cost analysis,” *Renew. Sustain. Energy Rev.*, vol. 42, pp. 569–596, 2015.
- [26] M. Skyllas-Kazacos and J. F. McCann, “Chapter 10 – Vanadium redox flow batteries (VRBs) for medium- and large-scale energy storage,” in *Advances in Batteries for Medium and Large-Scale Energy Storage*, 2015, pp. 329–386.
- [27] K.-P. Kairies, “Battery storage technology improvements and cost reductions to 2030: A Deep Dive,” *Int. Renew. Energy Agency Work.*, 2017.
- [28] P. Ralon, M. Taylor, and A. Ilas, *Electricity storage and renewables: costs and market to 2030*, no. October. 2017.
- [29] R. Benato, G. Bruno, F. Palone, R. Polito, and M. Rebolini, “Large-Scale Electrochemical Energy Storage in High Voltage Grids: Overview of the Italian Experience,” *Energies*, vol. 10, no. 1, p. 108, Jan. 2017.
- [30] L. Sigrist and E. Peirano, “E-Highway2050: Battery Storage Technology Assessment,” in *WP3 workshop April 15th*, 2014.
- [31] I. Renewable Energy Agency, “IRENA-IEA-ETSAP Technology Brief 5: Electricity Storage,” 2012.

182 NA-S BATTERY

Contact information

Danish Energy Agency: Thomas Mandal Østergaard , tmo@ens.dk

Energinet.dk: Rune Duban Grandal, rdg@energinet.dk

Author: Rune Christensen (runch@dtu.dk), DTU Energy

Publication date

December 2018

Amendments after publication date

Date	Ref.	Description

Brief technology description

Na-S batteries are secondary (i.e. rechargeable) batteries and are designed for system level applications. They are both power-intensive and energy-intensive. Larger installations (34 MW – 50 MW) are used for time shifting of production from renewable or conventional production plants. Smaller installations (400 kW – 8 MW) are used as back-up power, for off-grid applications, and for ancillary services. [1]–[3]

Na-S battery cells consist of a molten sodium anode, a molten sulfur cathode, and a β -alumina oxide solid state electrolyte (BASE) incased in a single tube. A schematic of a Na-S battery cell can be seen in Figure 1.

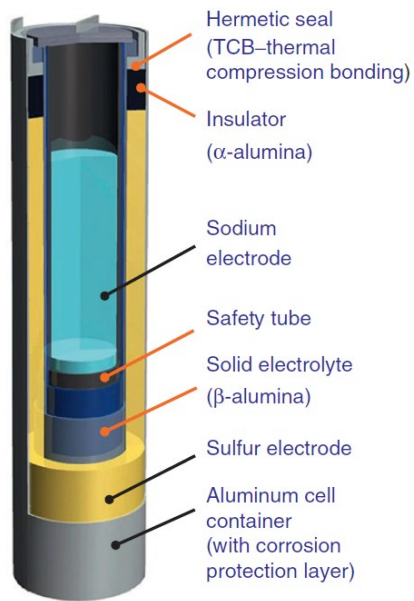
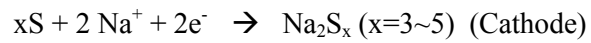
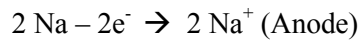
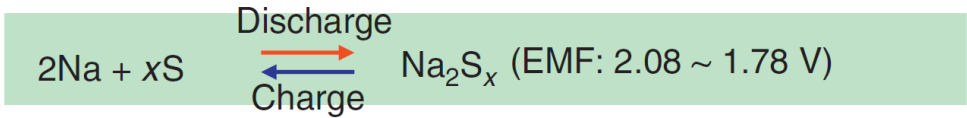
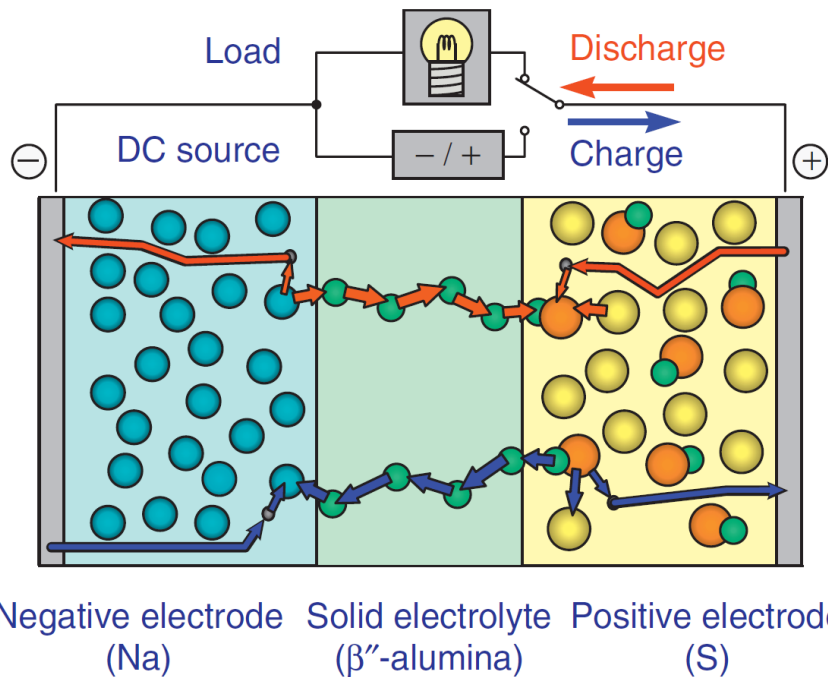

Figure 1: Schematic of a Na-S battery cell. [4]

The reactions taking place during discharge on the cathode and anode sides of the battery are [5], [6]



During charge the reverse reaction occurs. A graphical schematic of the reaction process and the full cell reaction can be seen in Figure 2.



- Na, elemental sodium
- Na⁺, sodium ion
- S, elemental sulfur
- Na₂S_x, sodium polysulfide
- e⁻, electron

Figure 2: Graphical schematic of the reaction process and the full cell reaction. EMF: electromotive force. [4]

During continued discharge the value of x in Na₂S_x will gradually decrease and more sodium rich discharge products will be formed. The reaction occurs at a potential of 1.78 – 2.08 V at 350 °C depending on the state of battery charge. Relatively high temperatures (300-350 °C) are required for the reaction to take place. Elevated temperatures are required to keep the electrodes molten (98 °C for Na, 115 °C for S, and > 250 °C for Na₂S_x products [7]). A temperature of 300 °C or more is required to ensure sufficient Na ion conductivity through the BASE. The production of BASE has large impact on both battery performance and cost [6].

Cells are arranged in modules with thermal enclosures to minimize heat loss. An illustration of a module can be seen in Figure 3.

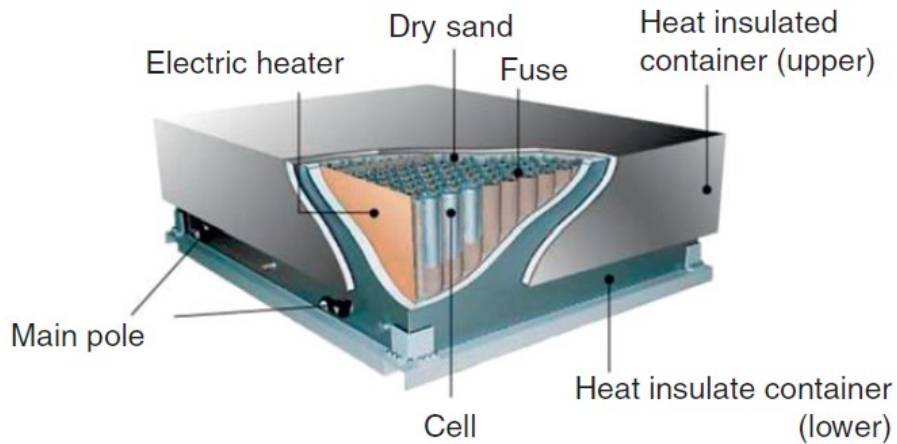

Figure 3: Illustration of Na-S battery module. [4]

A Na-S battery installation consists of one or more Na-S battery units containing the battery modules (shown in Figure 3), a battery management system, and a power conversion system required to connect the batteries to the grid. A schematic and a picture of an older 1 MW Na-S battery installation can be seen in Figure 4. For current market standard units see “

An alternative research route is to use the Na-S chemistry in a flow battery [20], [21].

Due to the similarity with Na-NiCl₂ batteries, synergies in research and development efforts can be expected.

Examples of market standard technology”.

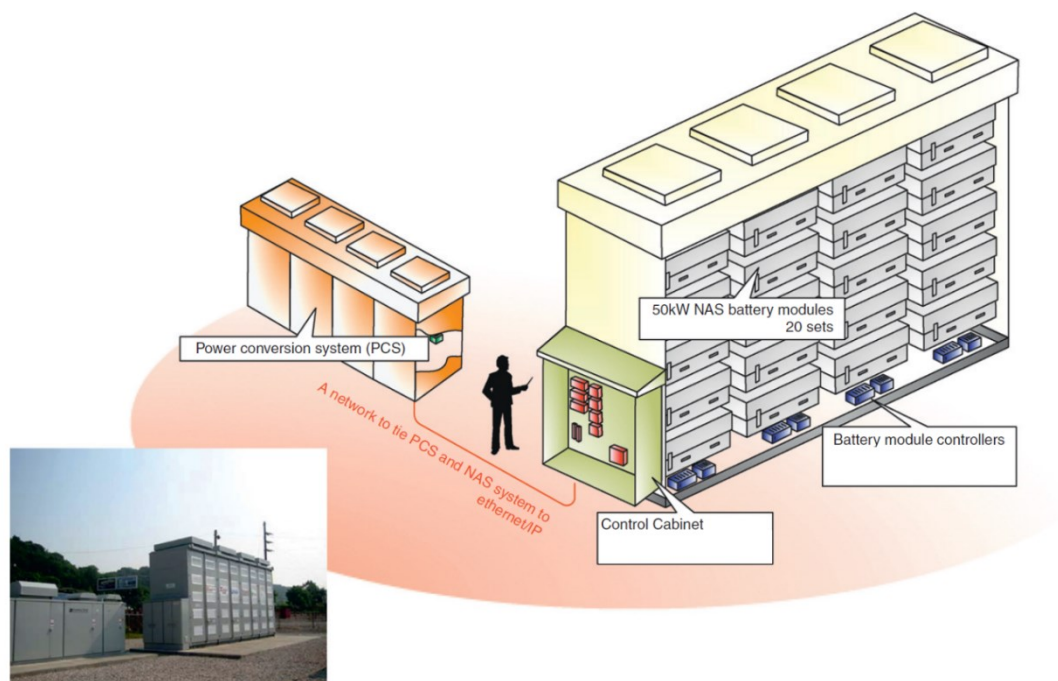

Figure 4: Schematic and picture of a 1 MW Na-S battery installation. [4]

For a more detailed technology description the reader is referred to “Encyclopedia of Electrochemical Power Sources” [8].

Input/Output

Primary input and output are both electricity. Electricity is converted to electrochemical energy during the charge process and converted back to electricity during the discharge process as described above.

Energy efficiency and losses

The heat loss from each battery module will be 2.2 – 4.0 kW [4]. This loss amounts to approximately 1 % per hour, and the Na-S batteries are thus not ideal for long term storage. During continued operation, which can include some hours of idle time, the Ohmic losses in the charge/discharge reaction will balance the heat loss [8]. The heat loss should thus not be treated as an independent source of energy loss during operation as it is included in the battery efficiency. Simple air cooling is sufficient for maintaining temperature and build into standard battery units. The battery temperature should be maintained to prevent the electrodes from solidifying since freeze-thaw cycles significantly reduce battery lifetime [9].

Individual battery cells have been measured with efficiencies at 89 % [9]. The efficiency of a grid size battery unit including auxiliary losses has been measured to be 83 % for an Italian installation primarily used for time shifting [9]. Reliable data for the efficiency in operation mode with constant power adjustment is not available for recently produced Na-S battery units.

Regulation ability and other system services



The response time (i.e. the time it takes for the battery to supply requested charge or discharge power) is according to the manufacture <1 ms at operation temperature[10]. Measurements find that the battery can change from full rated charging power to full rated discharging power in less than 50 ms [9] This is possibly limited by the power conversion system (PCS). Na-S batteries are able to provide energy pulses above rated discharge power for up to minutes at a time [8]. Pulses can be as large as 6 times rated power capacity for 30 s [11]. The other systems in the total installation, e.g., the PCS, and the grid connection must, however, be dimensioned accordingly for the pulse power capability to be utilized. This will increase cost.

Grid scale battery operation depends on the application. Batteries used for time shifting will generally complete a single charge/discharge cycle over 24 hours. Batteries used for various other grid services including stabilization of input from renewables will often not undergo traditional battery cycling but frequently switch between being charged and discharged according to demand.

Due to its short response time combined with relatively large storage and power capacity, Na-S batteries can provide a range of system services. NGK Insulators states: "The NAS battery systems also provide additional functions, including primary reserve, secondary reserve, load balancing and voltage control." [1]

Typical characteristics and capacities

Na-S battery installations come in two typical sizes. The larger installations used for time shifting have 34-50 MW capacity with 6-7.2 hours of storage capacity at full load (245-300 MWh). Information for three such installations are shown in Table 4. Smaller installations of up to 8 MW capacity have been installed during the last 20 years in 200 different locations [1]. In all cases the storage capacity corresponds to 6-8 hours of full power output capacity. As the batteries are highly modular, the installation size can be easily be varied according to demand. The power capacity to storage capacity is, however, for currently available commercial products fixed at a ratio of 1:6-8 [10].

Location	Rokkasho village, Aomori, Japan	Campania Region (3 sites), Italy	Buzen City, Fukuoka, Japan
			
Commissioned	2008	2015	2016

Storage capacity	245 MWh	250 MWh	300 MWh
Power capacity	34 MW	34.8 MW	50 MW
Energy density		<41.6 kWh/m ³ *	26 kWh/m ³
Specific energy		<76 Wh/kg**	56 Wh/kg
Total land use	17.5 m ² /MWh	77 m ² /MWh	47 m ² /MWh

Table 4: Larger Na-S battery installations [1], [9], [12]. *Value for individual battery assembly units. ** Value for individual battery modules

New installations will for economic reasons likely consist of the standard commercially available units mentioned in

An alternative research route is to use the Na-S chemistry in a flow battery [20], [21].

Due to the similarity with Na-NiCl₂ batteries, synergies in research and development efforts can be expected.

Examples of market standard technology. NGK Insulators states that container type units as those used for the Buzen City installation will decrease construction time and cost compared to previous installations.

The lifetime in number of cycles for Na-S batteries depend on the usage. The number of cycles can be increased by utilizing less than the full storage capacity in each cycle as can be seen in Figure 5. The ratio of energy discharged from the battery relative to the fully charged state is referred to as the Depth of Discharge (DoD). At 0 % DoD the battery is fully charged. At 100 % DoD the battery is fully discharged.

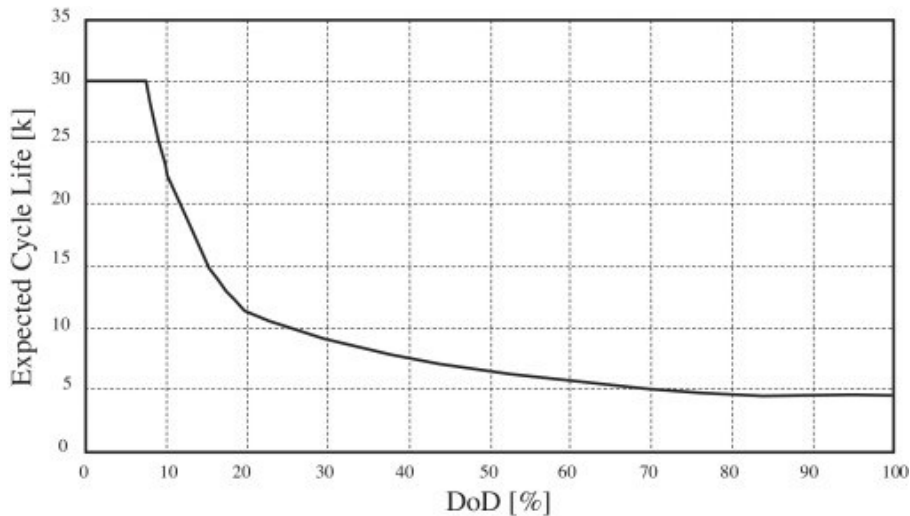

Figure 5: Expected number of cycles (in thousands) as function of Depth of Discharge (DoD) during cycles [9].

A Na-S battery used for time shifting with daily cycles of >80 % DoD will have an expected lifetime of 4500 cycles. If used for grid services, the average DoD will likely be smaller increasing the expected cycle lifetime. The technical lifetime is expected to be 15 years at a usage of 300 cycles at >80 % DoD per year [13] [14]. Longer technical lifetimes have not been reported. This is potentially due battery lifetime being limited by cycle lifetime during standard battery operation. An extended technical lifetime might not be obtainable by simply reducing the number of annual cycles or DoD for various reasons such as corrosion.

Typical storage period

The typical storage period depends on operation. It ranges from minutes to hours. With charge/discharge times of 6-8 h the normal storage period will be on this scale for optimal battery storage utilization.

Space Requirement

Space requirement per MWh are given in Table 4. The space requirements in Table 4 are calculated by dividing the total land use of the installations with the storage capacities. Footprint of current grid scale installations vary from 17.5 to 77 m²/MWh. The footprint is highly sensitive to the layout of the installation and the used battery units and other equipment. The value of 47 m²/MWh for Buzen City, where highly standardized container units are installed, is likely the most representative for future grid scale installations.

Advantages/disadvantages

General advantages and disadvantages of batteries in comparison to other technologies for energy storage are listed in Table 4.

Advantages	Disadvantages
Short response time	
Flexible installation size	Relatively short lifetime
High energy efficiency	
Versatile application	Large investment cost
Relatively compact	
Low maintenance	

Table 5: General advantages and disadvantages of batteries in comparison to other technologies for energy storage

Compared to many other batteries, Na-S batteries have the advantage that they are composed of inexpensive and abundant raw materials. Therefore, they have the potential to be very low cost and be manufactured on very large scale. Na-S batteries are well proven and developed for grid scale applications and have been commercially available for grid scale purposes for 15 years. They are well suited for energy intensive storage applications but can also be used for power intensive purposes. The cost per MW power capacity is, however, larger than for batteries mainly intended for power intensive applications. Na-S batteries have significant pulse power capabilities, i.e. they can operate at higher power than rated for short durations of time [8], [11].

Na-S batteries require high temperatures and should remain heated, as the battery can only survive a limited (in the order of 20) freeze-thaw cycles in which the temperature is lowered and the molten electrodes solidify [9]. They are thus not suited for longer periods of idle storage with resulting heat losses but should ideally always be charging or discharging for optimal utilization. The market for Na-S batteries is currently limited, due to only one commercial manufacturer existing. Due to the elevated temperatures and the highly reactive molten electrode materials, safety concerns and requirements are also higher for Na-S batteries than most other types of batteries. However, only one safety incident has been reported as a battery caught fire in 2011 [6].

Environment

The batteries contain molten sodium, sulfur and polysulfides. These all pose potential safety risks. Detailed safety and risk assessments are available in references [4], [9]. Sodium is the only material which must be recycled as hazardous [4].

Research and development perspectives

It is not possible to quantify the full potential for improvements through R&D at the given time. The potential is however, estimated to be substantial in terms of both technical and financial specifications [15].

All critical components of the battery are undergoing active research. These include the BASE, the sealing materials, the sodium electrode, the sulfur electrode, and battery interfaces [16]. Research efforts are especially focused on geometry optimizations [17] [18] and improvement of Na ionic conductivity through the BASE [19]. New solid electrolytes to replace BASE are also being considered [15].

An alternative research route is to use the Na-S chemistry in a flow battery [20], [21].

Due to the similarity with Na-NiCl₂ batteries, synergies in research and development efforts can be expected.

Examples of market standard technology

NGK Insulators is the only commercial manufacturer of Na-S batteries. They currently supply two types of modular units which are shown in Figure 6. These modular units can be used to form installations of the desired size. The recently installation in Buzen City consist of container type units such as the units shown in Figure 6.

New container type unit

The NAS battery system is a “Plug and Play” design built around standard 20 foot ocean freight containers. The containerized design expedites transportation and installation and helps minimize installation costs.

Rated Output	800kW and 4,800kwh
Configuration	Four container subunits, series connected. A subunit includes six NAS modules, each rated at 33kW and 200kWh.
Dimension	6.1W x 5.6D x 5.5H (m)
Weight	86tonnes

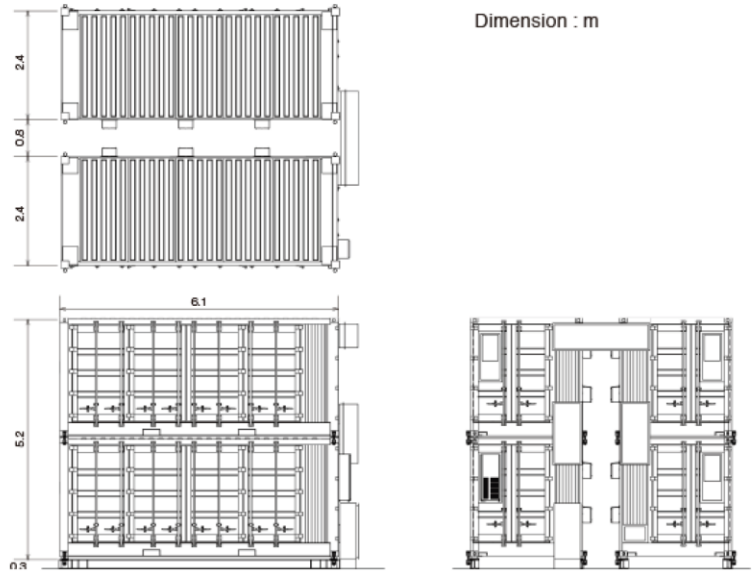

Package type unit

The enclosure package and battery modules are installed on site. This design achieves more compact system comparing with containerized design.

Rated Output	1,200kW and 8,640kWh
Configuration	40 NAS modules, each rated at 30kW and 216kWh.
Dimension	10.2W x 4.4D x 4.8H (m)
Weight	132tonnes

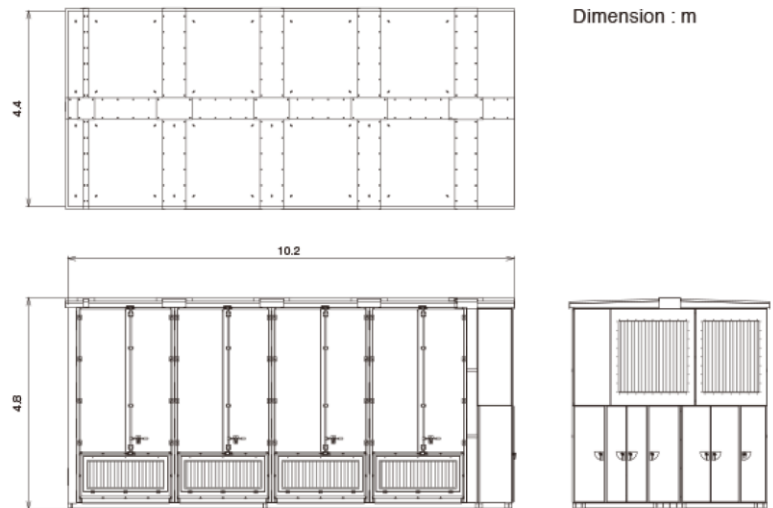

Figure 6: Commercial units available from NGK Insulators (<https://www.ngk.co.jp/nas/>) [10].

Prediction of performance and cost

Data for 2015

The Italian case (Campania Region) presented above has been used for economic data to as large an extent as possible [9], [22]. A significant reason for placing emphasis on this specific installation is that the owner, Italian grid operator Terna, has made financial and measured technical data available. Using real data is preferred

over the use of estimates. However, it should be noted, that the cost might be relatively large compared to the market situation since Terna, for safety considerations following a 2011 fire incident in a Na-S battery, have requested fewer battery cells in each module than standard.

The balance between power capacity and energy storage capacity in battery installations will influence the investment costs per MW and MWh. The ratio can be quantified through the discharge time at rated power, h . It is nearly constant at 6-7.2 hours for currently available units. h is used to calculate the investment cost per storage capacity from the investment cost per power capacity.

O&M costs are obtained from Carlsson et al. [23] (assumed similar to 2013 values), and Zakeri and Syri [24].

Assumptions for the period 2020 to 2050

Estimates for 2020 and 2030 in the data sheet below are based on data from IRENA [25]–[27]. Values in USD have been converted to € using an exchange rate of 0.86. The specific investment cost is adjusted to account for an expected decrease in h for the most common market-standard units from 7.2 h to 6 h.

As discussed in the Chapter Electricity Storage, the current PCS cost including grid connection is 0.4-0,5 M€/MW. This is used as reference value for the “capacity component”. The inverter costs, which account for approximately 50 % of cost [13], [22], [24], is predicted to decrease by 20 % in 2020 and 50 % in 2030 [25], [26]. The other 50 % of cost is assumed constant. Cost reductions of capacity components is assumed to not occur beyond 2030.

2050 values of the battery cost (here “energy component”) predicted from learning curves have previously found cost reductions of approximately 10 % [23] and 25 % [28] for the period 2030 to 2050. The average (17.5 %) is used for the energy component cost in 2050.

“Other project costs” is assumed to be 14 % of CAPEX (here “Specific investment”), as was the case for the Terna unit [29].

O&M costs are assumed to be constant in the given units.

No development in calendar lifetime, cycle lifetime, and efficiency is assumed to take place beyond 2030. The regulatory ability is assumed to not improve.

Learning curves and technological maturity

Cost has been reduced with the introduction of large scale production of highly standardized units [12]. The level of maturity for system level scale is late “Category 2: Pioneer Phase” but entering “Category 3: Commercial technologies with moderate deployment”.

Uncertainty

As the technology is just about to enter Category 3 level maturity, a technology development track cannot yet be established without large uncertainty. Uncertainties for 2020 and 2030 are when possible obtained from IRENA [26], [27]. Uncertainties in 2050 are assumed to be percentagewise similar to those in 2030. For the

“capacity component” the maximum values for PCS cost found by Zakeri and Syri [24] are used as baseline. The uncertainties are calculated for future years by keeping the relative uncertainty compared to the cost prediction constant.

The uncertainties for O&M costs are determined using the literature review by Zakeri and Syri [24]. The uncertainties are calculated from the expected value using the relative difference between the extrema and the average in the literature review. Uncertainties are in general large.

Additional remarks

Since battery units are highly modular and equipment is the main cost of a full installation, a close to linear scaling in total cost vs. installation size is expected from a technological point of view. Significant financial benefits from increasing installation sizes will rely on negotiations with the manufacturer.

Even though Na-S batteries have high commercial potential, rapid cost reduction of alternative storage solutions, e.g., Li-ion batteries, might halter commercial deployment and technological development of Na-S batteries. This can prevent Na-S batteries from reaching full commercial potential.

Quantitative description

Technology	NaS battery									
	2015	2020	2030	2050	Uncertainty (2020)		Uncertainty (2050)		Note	Ref
Energy/technical data	Lower		Upper		Lower		Upper			
Form of energy stored	Electricity									
Application	System, power- and energy-intensive									
Energy storage capacity for one unit (MWh)	250	300	300	300	30	3000	30	3000	A,B,Q	[9]
Output capacity for one unit (MW)	35	50	50	50	5	500	5	500	A,B,Q	[9]
Input capacity for one unit (MW)	35	50	50	50	5	500	5	500	A,B,Q	[9]
Round trip efficiency - DC (%)	83	83	85	85	71	92	74	96	C	[9];[26]
- Charge efficiency (%)	-	-	-	-	-	-	-	-		
- Discharge efficiency (%)	-	-	-	-	-	-	-	-		
Energy losses during storage (%/day)	0	0	0	0	0	1	0	1	D,Q	[11];[30];[26]
Forced outage (%)	0	0	0	0	0	2	0	2	E,Q	[13]
Planned outage (weeks per year)	0	0	0	0	0	0	0	0	F,Q	[13]
Technical lifetime (years)	15	19	24	24	10	28	14	36	G	[13];[25]+[27]
Construction time (years)	0.5	0.5	0.5	0.5	0.2	2.0	0.2	2.0	Q	[1]
Regulation ability										
Response time from idle to full-rated discharge (sec)	0.001	0.001	0.001	0.001	0.001	0.02	0.001	0.02	H	[10]+[28]
Response time from full-rated charge to full-rated discharge (sec)	0.050	0.050	0.050	0.050	0.001	0.05	0.001	0.05	H,I,Q	[9]
Financial data										
Specific investment (M€2015 per MWh)	0.46	0.37	0.23	0.20	0.25	0.73	0.13	0.39	G	[22];[25]+[26]
- energy component (M€/MWh)	0.31	0.25	0.14	0.11	0.18	0.50	0.08	0.23	G, J	[22]+[26]
- capacity component (M€/MW)	0.63	0.41	0.33	0.33	0.22	0.78	0.18	0.64	G, K	[22]+[26]
- other project costs (M€/MWh)	0.06	0.05	0.03	0.03	0.04	0.10	0.02	0.05	G	[22]+[26]
Fixed O&M (% total investment)	1.5	1.5	1.5	1.5	0.8	7.2	0.8	7.2	G,L,M	[23];[24]
Variable O&M (€2015/MWh)	1.8	1.8	1.8	1.8	0.3	5.6	0.3	5.6	G	[24]+[23]
Technology specific data										
Alternative investment cost (M€2015/MW)	3.3	2.2	1.4	1.2	1.5	4.4	0.8	2.3	G	[22];[25]+[26]
Lifetime in total number of cycles	4500	5600	7500	7500	1100	11200	1500	15000	N, G	[9];[25]+[27]
Specific power (W/kg)	9.3	9.3	9.3	9.3	6.98	11.63	6.98	11.63	O,P,Q	[10]
Power density (W/m ³)	4300	4300	4300	4.300	3225	5375	3225	5375	O,P,Q	[10]
Specific energy (Wh/kg)	56	56	56	56	42	70	42	70	O,P,Q	[10]
Energy density (Wh/m ³)	26000	26000	26000	26000	19500	32500	19500	32500	O,P,Q	

Notes:

- A Specific Italian installation from 2015 used here as example. Assuming installations similar to Buzen City discussed above to become standard in the future.
- B Highly modular technology type with near linear scaling between total cost and installation size. Power and storage capacity cannot be varied independently.
- C Grid size unit including balancing and auxiliary losses. Excluding converters. Assumes no improvement between 2030 and 2050.
- D Ohmic losses maintain the temperature of the battery during operation. Losses are thus included in round trip efficiency [7]. No electrical self-discharge. If idle the heat loss is as much as 1 % of storage capacity per hour but highly variational. IRENA reports as “worst” value of 1.0 % [26]
- E Forced outage is minimal. Only reported case is a 2011 fire incident [9].
- F On the order of 1 h per year.
- G Assumptions for development and uncertainty discussed above in “Prediction of performance” and “Uncertainty”.
- H Due to absence of predictions in literature, no development is assumed as an estimate.
- I Measurement. Possibly limited by PCS.
- J Includes “Batteries” from reference [22] for 2015 values.
- K Includes “PCS-SCI”, “Auxiliary equipment”, and “Switching and actuating equipment” from reference [22] for 2015 values.
- L Highly uncertain. Reported in range 2000 to 17300 €/2015/MW/year [24]
- M Does not include replacement costs. The batteries do not need replacement within lifetime [13],[10].
- N See Figure 5.
- O Data for standard NGK container unit.
- P Not the technological maximum values, i.e., the density of single cells, but the specifications for a full market-standard commercial product.
- Q Uncertainties are based on a qualified guess.

References

- [1] NGK Insulators LTD, "Case Studies." pp. 1–13, 2016.
- [2] "DOE Global Energy Storage Database." [Online]. Available: <https://www.energystorageexchange.org/>. [Accessed: 29-Mar-2017].
- [3] IEC, "Electrical Energy Storage," 2011.
- [4] C.-H. Dustmann and A. Bito, "SECONDARY BATTERIES – HIGH TEMPERATURE SYSTEMS | Safety," in Encyclopedia of Electrochemical Power Sources, 2009, pp. 324–333.
- [5] B. Dunn, H. Kamath, and J.-M. Tarascon, "Electrical Energy Storage for the Grid: A Battery of Choices," Science (80-.), vol. 334, no. 6058, pp. 928–935, 2011.
- [6] J. Cho, S. Jeong, and Y. Kim, "Commercial and research battery technologies for electrical energy storage applications," Prog. Energy Combust. Sci., vol. 48, pp. 84–101, Jun. 2015.
- [7] J. Garche and C. K. Dyer, Encyclopedia of electrochemical power sources. Academic Press, 2009.
- [8] R. Holze, "SECONDARY BATTERIES – HIGH TEMPERATURE SYSTEMS: Sodium-Sulfur," in Encyclopedia of Electrochemical Power Systems, vol. 200, 2009, pp. 302–311.
- [9] M. Andriollo et al., "Energy intensive electrochemical storage in Italy: 34.8 MW sodium-sulphur secondary cells," J. Energy Storage, vol. 5, pp. 146–155, Feb. 2016.
- [10] NGK Insulators LTD, "Structure of NAS Energy Storage System," 2016. [Online]. Available: <https://www.ngk.co.jp/nas/specs/>.
- [11] H. Chen, T. N. Cong, W. Yang, C. Tan, Y. Li, and Y. Ding, "Progress in electrical energy storage system: A critical review," Prog. Nat. Sci., vol. 19, no. 3, pp. 291–312, 2009.
- [12] NGK Insulators LTD, "The World's Largest NAS Battery Installation Commences Operation Short Installation Period Achieved through Containerized, Compact Format," 2016. [Online]. Available: <http://www.ngk.co.jp/english/news/2016/0303.html>.
- [13] G. Huff et al., "DOE/EPRI 2013 electricity storage handbook in collaboration with NRECA," Rep. SAND2013- ..., no. July, p. 340, 2013.
- [14] NGK Insulators LTD, "Comparison of Battery Technologies | Why NAS? | NAS." [Online]. Available: <https://www.ngk.co.jp/nas/why/comparison.html>. [Accessed: 13-Sep-2017].

- [15] O. Teller et al., "Joint EASE/EERA Recommendations for a European Energy Storage Technology Development Roadmap Towards 2030," 2013.
- [16] Z. Wen, Y. Hu, X. Wu, J. Han, and Z. Gu, "Main Challenges for High Performance NAS Battery: Materials and Interfaces," *Adv. Funct. Mater.*, vol. 23, no. 8, pp. 1005–1018, Feb. 2013.
- [17] G. Kim, Y.-C. Park, Y. Lee, N. Cho, C.-S. Kim, and K. Jung, "The effect of cathode felt geometries on electrochemical characteristics of sodium sulfur (NaS) cells: Planar vs. tubular," *J. Power Sources*, vol. 325, pp. 238–245, Sep. 2016.
- [18] S. I. Kim, W. Il Park, K. Jung, and C.-S. Kim, "An innovative electronically-conducting matrix of the cathode for sodium sulfur battery," *J. Power Sources*, vol. 320, pp. 37–42, Jul. 2016.
- [19] K. . Ahlbrecht, C. Bucharsky, M. Holzapfel, J. Tübke, and M. J. Hoffmann, "Investigation of the wetting behavior of Na and Na alloys on uncoated and coated Na- β -alumina at temperatures below 150 °C," *Ionics (Kiel)*, pp. 1–9, Mar. 2017.
- [20] X. Yu and A. Manthiram, "Ambient-Temperature Sodium-Sulfur Batteries with a Sodiated Nafion Membrane and a Carbon Nanofiber-Activated Carbon Composite Electrode," *Adv. Energy Mater.*, vol. 5, no. 12, pp. 1–6, 2015.
- [21] X. Yu and A. Manthiram, "Performance Enhancement and Mechanistic Studies of Room-Temperature Sodium–Sulfur Batteries with a Carbon-Coated Functional Nafion Separator and a Na₂S/Activated Carbon Nanofiber Cathode," *Chem. Mater.*, vol. 28, no. 3, pp. 896–905, Feb. 2016.
- [22] R. Benato, G. Bruno, F. Palone, R. Polito, and M. Rebolini, "Large-Scale Electrochemical Energy Storage in High Voltage Grids: Overview of the Italian Experience," *Energies*, vol. 10, no. 1, p. 108, Jan. 2017.
- [23] J. E. Al Carlsson, "ETRI 2014 - Energy Technology Reference Indicator projections for 2010-2050," 2014.
- [24] B. Zakeri and S. Syri, "Electrical energy storage systems: A comparative life cycle cost analysis," *Renew. Sustain. Energy Rev.*, vol. 42, pp. 569–596, 2015.
- [25] K.-P. Kairies, "Battery storage technology improvements and cost reductions to 2030: A Deep Dive," *Int. Renew. Energy Agency Work.*, 2017.
- [26] IRENA, "Electricity storage and renewables: Costs and markets to 2030 - Cost-of-service tool. Version 1.0," 2017.
- [27] P. Ralon, M. Taylor, and A. Ilas, "Electricity storage and renewables: costs and market to 2030," no. October. 2017.
- [28] L. Sigrist and E. Peirano, "E-Highway2050: Battery Storage Technology Assessment," in WP3 workshop April 15th, 2014.

- [29] R. Benato et al., "Sodium nickel chloride battery technology for large-scale stationary storage in the high voltage network," *J. Power Sources*, vol. 293, pp. 127–136, 2015.
- [30] G. L. Soloveichik, "Battery Technologies for Large-Scale Stationary Energy Storage," *Annu. Rev. Chem. Biomol. Eng.*, vol. 2, pp. 503–27, 2011.

183 NA-NICL₂ BATTERIES

Contact information:

Danish Energy Agency: Thomas Mandal Østergaard , tmo@ens.dk

Energinet.dk: Rune Duban Grandal, rdg@energinet.dk

Author: Rune Christensen (runch@dtu.dk), DTU Energy

Publication date

December 2018

Amendments after publication date

Date	Description
15.03.2019	Correction in the datasheet to the “Energy storage capacity for one unit (MWh)”, “Output capacity for one unit (MW)” and “Input capacity for one unit (MW)”. Correction to note I.

Brief technology description

Na-NiCl₂, or Sodium-nickel chloride, batteries are secondary (i.e. rechargeable) batteries. They are also known as ZEBRA (Zeolite Battery Research Africa Project) batteries. They are applicable for both power-intensive and energy-intensive electrical energy storage. They can be used on both grid level and for mobile applications such as electric and hybrid vehicles [1].

Na-NiCl₂ batteries are similar to the more mature Na-S batteries. The key components of a Na-NiCl₂ battery cell are the molten sodium anode, a ceramic β-alumina oxide solid state electrolyte (BASE), and a porous cathode, where the reactant is NiCl₂. The cathode also contains liquid NaAlCl₄ to obtain sufficient ionic conductivity [2], [3]. A schematic of a cell can be seen in Figure 1.

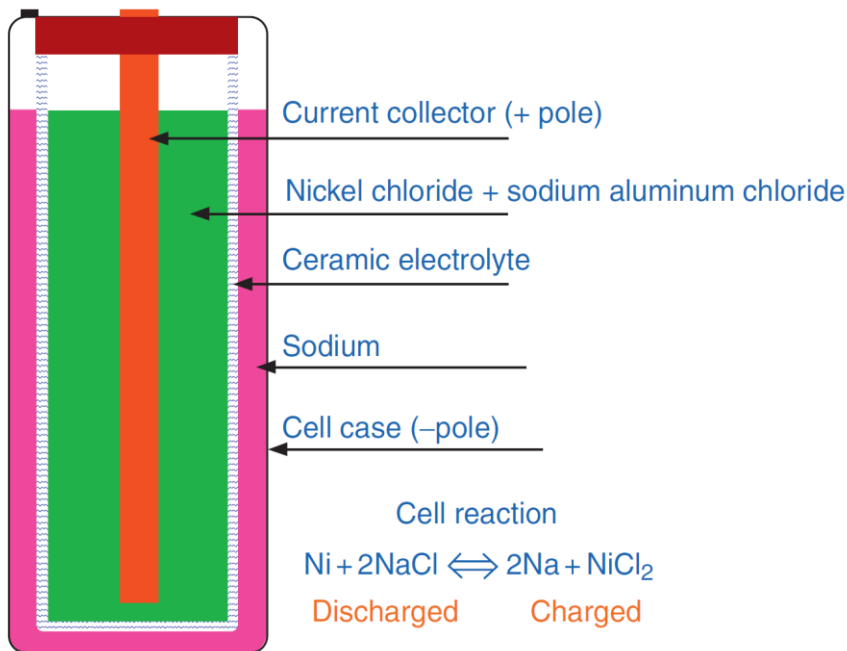

Figure 1: Schematic of Na-NiCl₂ battery cell. The “Ceramic electrolyte” is BASE [1].

A picture of five connected cells and the components used to manufacture a cell can be seen in Figure 2.

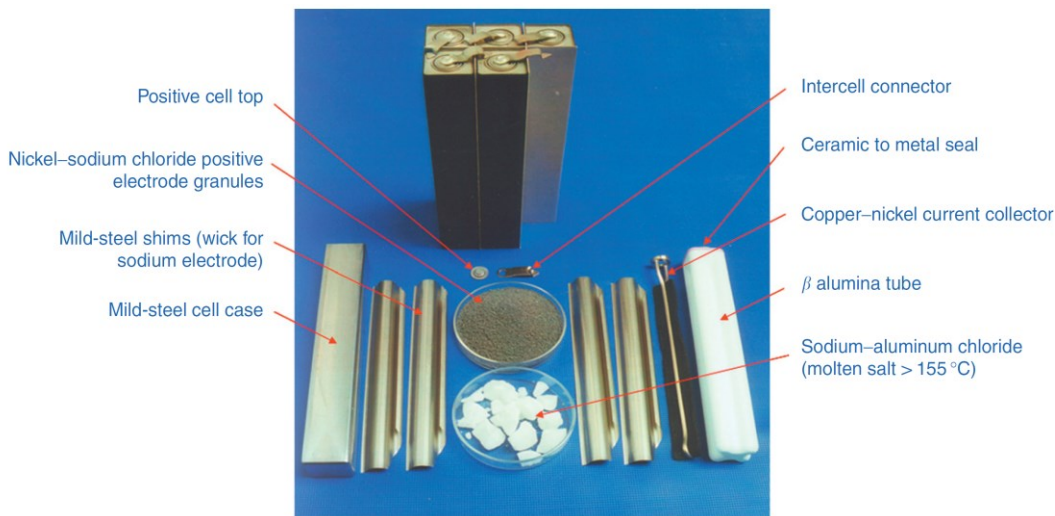
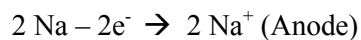
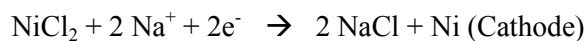

Figure 2: Na-NiCl₂ battery cell components [1].

Cells are assembled in a fully discharged state. This allows the sodium to be supplied in the form of NaCl as can be seen from the discharge reaction:





During charge the reverse reaction occurs. The reaction has a full cell potential of 2.58 V at 300 °C. The operating temperature is 250 °C to 350 °C to ensure sufficient Na ionic conductivity through the BASE [4]. A lower limit operation temperature of 150 °C is required to maintain liquid NaAlCl₄ [1]. An illustration of the charging reaction can be seen in Figure 3.

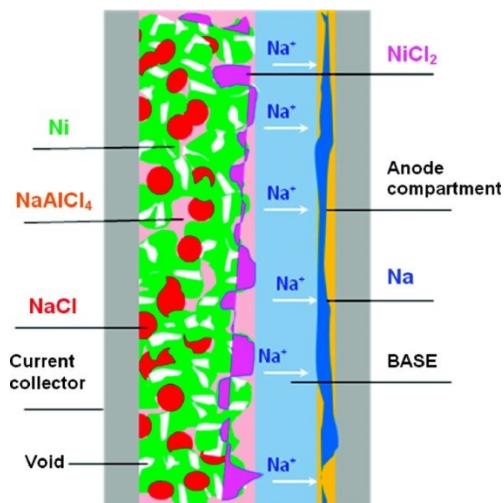

Figure 3: Illustration of Na-NiCl₂ charging process [2].

The battery cells are connected in battery units with thermal insulation, heating and cooling systems, and various control systems. Battery modules can be combined in larger battery units for grid scale applications. Current commercial grid scale units are shown in Section “Examples of market standard technology”. A grid scale Na-NiCl₂ battery installation consists as a minimum of a unit containing the battery modules, a battery management system, and a power conversion system required to connect the batteries to the grid.

For a more detailed technology description the reader is referred to “Encyclopedia of Electrochemical Power Sources” [1].

Input/output

The primary input and output are both electricity. Electricity is converted to electrochemical energy during charge. The electrochemical energy is converted back to electricity during discharge in the reaction process described above.

Energy efficiency and losses

Heat loss is reported to be less than 0.6 % of total energy storage capacity per hours for a 17.8 kWh battery module and less than 0.3 % of total storage capacity per hour for a 35.7 kWh battery module [1]. The heat loss depends on the specific assembly unit. Heat loss in large battery installations consisting on multiple assembly

units, e.g., 10 identical container assembly units, each containing multiple battery modules is expected to scale approximately linearly with installation size. The heat loss in percentage of total energy storage capacity is thus approximately independent of total installation size. During continued operation, which can include some hours of idle time, the Ohmic losses in the charge/discharge reaction will balance the heat loss. The heat loss should thus not be treated as an independent source of energy loss during operation as it is included in the battery efficiency. Simple air cooling is sufficient for maintaining temperature during operation and build into standard battery units.

Na-NiCl₂ batteries can be repeatedly cooled to ambient temperatures and reheated, i.e. undergo so-called freeze-thaw cycles, without any decrease to battery lifetime [1], [4], [5]. Typical time scales are days to solidify during cooling and tens of hours to liquidize during reheating [6]. Na-NiCl₂ batteries should remain heated during shorter idle periods.

At grid scale battery operation, the DC efficiency of a Na-NiCl₂ module has been measured to 90 % [7]. A 0.5 MW Na-NiCl₂ battery unit has been measured to 89 % [4]. Auxiliary losses, e.g., from cooling account for approximately 2 % [7].

Regulation ability and other system services

Standard recharging is slower than discharging the battery, i.e. the standard charging input will be lower than the rated output capacity. Commercial data states 6-8 hours to recharge a battery with 3 hour capacity at rated discharge capacity [1], [8]. Fast recharge at a rated equal to or above the rated output power is possible at the cost of decreased energy efficiency and accelerated battery degradation [9]. At low charge/discharge rates (approximately 1/3 of rated power) the full battery energy storage capacity can be used. At rated power output only 80 % of storage capacity should be utilized to prevent accelerated degradation [4].

The response time (i.e. the time it takes for the battery to supply requested charge or discharge power) is stated to be 20 ms [10] and measured to be less than 1 second when the battery is operational [4]. The response time from non-operational mode with the battery at operating temperature takes 45 seconds. [4].

Given the necessary power conversion system (PCS) equipment etc. is installed, Na-NiCl₂ batteries are able to provide energy pulses of up to at least 3 times rated power capacity for periods measured as long as 30 min but with storage capacity reduced by a factor of two compared to rated discharge rate [4]. The effect of such operation on battery lifetime is not known.

Grid scale battery operation depends on the application. Batteries used for time shifting will generally complete a single charge/discharge cycle over 24 hours. Batteries used for various other grid services including stabilization of input from renewables will often not undergo traditional battery cycling but frequently switch between being charged and discharged according to demand.

Na-NiCl₂ batteries can provide a range of system services. The manufacturer FZSoNick states the following applications: Load levelling, power quality, renewable resource optimization, and utility grid ancillary services [8].

Typical characteristics and capacities

Some noteworthy European stationary installations of Na-NiCl₂ batteries are listed in Table 1.

Name	Location	Year of commissioning	Storage capacity	Rated power output capacity
FIAMM Green Energy Island	Almisano, Italy	2010	230 kWh	180 kW
EDF EN Gabardone Project	Colombiers, France	2013	70 kWh	20 kW
Terna Storage Lab 1+2 (3 installations)	Codrungianos (Sardinia) and Ciminna (Sicily), Italy	2014 and 2015	4150 kWh 2000 kWh 4150 kWh	1200 kW 1000 kW 1200 kW

Table 1: Selected Na-NiCl installations in Europe [4], [11], [12].

The energy density and specific energy calculated for the Energy Spring 164 system from FZSoNick [8] (See Figure 5) is 32.8 kWh/m³ and 56 Wh/kg, respectively.

Typical storage period

The storage period for Na-NiCl₂ batteries depends on the operation of the batteries and can range from minutes to hours.

Space Requirement

For the Energy Spring 164 system from FZSoNick [8], the footprint of a single battery assembly unit is 10.5 m²/MWh. Data is not available for footprint of full installations of Na-NiCl₂ batteries. Assuming Na-NiCl₂ battery assembly units will occupy a similar fraction of total installation area as Na-S battery units, the total installation footprint can be estimated to 70 – 116 m²/MWh on the basis of large recent Na-S battery installations [13]–[15]. This estimate takes into consideration that the battery unit footprint is 1.5 times larger per MWh for current commercially available Na-NiCl₂ battery units than commercially available Na-S battery units (See Figure 5 and reference [16]).

Advantages/disadvantages

General advantages and disadvantages of batteries in comparison to other technologies for energy storage are listed in Table 3.

Advantages	Disadvantages
Short response time	
Flexible installation size	Relatively short lifetime
High energy efficiency	
Versatile application	Large investment cost
Relatively compact	
Low maintenance	

Table 3: General advantages and disadvantages of batteries in comparison to other technologies for energy storage

Even compared to other batteries, Na-NiCl₂ batteries are considered reliable and low maintenance [8], [17]. Na-NiCl₂ are high temperature batteries, however they can operate at lower temperatures than Na-S batteries. They can in contrast to Na-S batteries withstand repeated cooling and reheating without degradation [4], [5]. They have significant pulse power capabilities, i.e. they can operate at higher power than rated for short durations of time [18][19]. They are among the most efficient large scale batteries. They are, despite the highly reactive molten sodium electrode and elevated temperatures, considered relatively safe due to intrinsic safety features [4], [18], [20].

The batteries are currently expensive compared to other batteries for grid scale application for both energy intensive and power intensive applications. There is currently only one trading manufacturer. The energy storage capacity is directly coupled to the usage of nickel, which account for 47% [21] to 60 % [22] of raw material costs. The raw material cost of nickel is approximately 18 \$/kWh at a price of 11.6 \$/kg [21]–[23]. Cost of Ni is currently not critical to the overall battery cost but could become significant in case of large production cost reductions.

Environment

Operating batteries contain molten sodium, which pose a potential safety and environmental risks. Risk analyses can be found in References [4], [20]. Raw materials used in the production of Na-NiCl₂ batteries are nonhazardous and globally available [20]. Discharged batteries can easily be recycled and the nickel reclaimed [17], [20]. A detailed Life Cycle Assessment (LCA) can be found in Reference [24].

Research and development perspectives

It is not possible to quantify the full potential for improvements through R&D at the given time. The potential is however, estimated to be substantial in terms of both technical and financial specifications [25].

All critical components of the battery are undergoing active research. These include the BASE, the sealing materials, the sodium electrode, the cathode, and battery interfaces. Research efforts are especially focused on geometry optimizations and improvement of Na ionic conductivity through the BASE. New solid electrolytes to replace BASE are also being considered [25].

Research is also going into slightly changed chemistries which would change the battery characteristics significantly [3], [26].

Due to the similarity with Na-S batteries, synergies in research and development efforts can be expected.

Examples of market standard technology

FZSoNick, a subsidiary of FIAMM, is the only currently trading commercial manufacturer of Na-NiCl₂ batteries [8]. Illustration and technical specifications available at below referenced URL are presented for a grid scale assembly unit in Figure 4 - Figure 5. Units are highly modular and can be combined to an installation of desired size.



Figure 4: Energy Spring 164 system from FZSoNick [8].

Energy Spring 164 Technical Specification for configuration of 64 ST523

Battery / Chemistry Type	NaNiCl ₂
Constant Power Discharge (Rated)	400 kW for 3 hours
Nominal Energy Capacity	1.4 MWh (100% DOD)
System Rating (Voltage, Current Capacity)	Nom. 620 VDC, Nom. 2432 Ah
Min / Max Operative System Voltages	500 VDC / 700 VDC
Standard Charge / Discharge hours	8 hours of charge, 3 hours of discharge
Standard Circuit Design	Up to 64 battery modules connected in parallel
Enclosure Dimensions	L: 6058 mm / 238.5 in H: 2896 mm / 114 in W: 2438 mm / 96 in
Weight (metric ton)	25 t (with battery modules), 10 t (without battery modules)
Heater Consumption during floating	<10 kW
Ventilation	Not need Air Conditioning, only forced-air ventilation for power electronics
Design Cycle Life	4500 Cycles at 80% DOD
Product / Material Specifications	Please refer to ST523 battery specifications
BMS Characteristics	Please refer to ST523 battery specifications

Figure 5: Specifications for Energy Spring 164 system from FZSoNick [8]. http://www.fzsonick.com/media/369733/20161221_energy-spring-164_datasheet-a4.pdf

Prediction of performance and cost

Data for 2015

The Italian “Terna Storage Lab” installation reported above has been used for economic data to as large extend as possible [4], [12]. A significant reason for placing emphasis on this specific installation is that the owner, Italian grid operator Terna, has made financial and measured technical data available. This is preferred over estimates.

The balance between power capacity and energy storage capacity in battery installations will influence the investment costs per MW and MWh. The ratio can be quantified through the discharge time at rated power, h , and has historically varied. Calculated as a weighted average for the “Terna Storage Lab”, h is 3 hours. This is similar to h for currently available commercial grid-scale units.

O&M costs are obtained from Carlsson et al. [27] (assumed similar to 2013 values for Na-S batteries in good agreement with EPRI data [28]), and Zakeri and Syri [29]. It is highly uncertain how O&M costs will change in the future with deployment of highly standardized container type units.

Assumptions for the period 2020 to 2050

Estimates for 2020 and 2030 in the data sheet below are based on data from IRENA [30]–[32]. Values in USD have been converted to € using an exchange rate of 0.86.

As discussed in the Chapter Electricity Storage, the current PCS cost including grid connection is 0.4-0,5 M€/MW. This is used as reference value for the “capacity component”. The inverter costs, which account for approximately 50 % of cost [13], [22], [24], is predicted to decrease by 20 % in 2020 and 50 % in 2030 [25], [26]. The other 50 % of cost is assumed constant. Cost reductions of capacity components is assumed to not occur beyond 2030.

2050 values of the battery cost (here “energy component”) predicted from learning curves have previously found cost reductions of approximately 10 % [23] and 25 % [28] for the period 2030 to 2050 for Na-S batteries. As Na-S and Na-NiCl₂ batteries have similar cost drivers, the average (17.5 %) is used for the energy component cost in 2050.

“Other project costs” is assumed to be 8 % of CAPEX (here “Specific investment”), as was the case for the Terna unit [29].

O&M costs are assumed to be constant in the given units.

No development in calendar lifetime, cycle lifetime, and efficiency is assumed to take place beyond 2030. The regulatory ability is assumed to not improve.

Learning curves and technological maturity

The level of maturity for grid scale Na-NiCl₂ batteries is “Category 2: Pioneer Phase”. Based on the current commercial situation it is not possible to establish learning curves. The technology is for grid scale applications suffering from slow rate of deployment compared to other grid scale batteries despite being relatively old. It is doubtful whether grid scale Na-NiCl₂ batteries will ever achieve Category 3 maturity: “Commercial technologies with moderate deployment”.

Uncertainty

As the technology is in Category 2 level maturity, a technology development track cannot yet be established without large uncertainty. Uncertainties for 2020 and 2030 are when possible obtained from IRENA [26], [27]. Uncertainties in 2050 are assumed to be percentagewise similar to those in 2030. For the “capacity component” the maximum values for PCS cost found by Zakeri and Syri [24] are used as baseline. The uncertainties are calculated for future years by keeping the relative uncertainty compared to the cost prediction constant.

The uncertainties for O&M costs are determined using the literature review by Zakeri and Syri [24]. The uncertainties are calculated from the expected value using the relative difference between the extrema and the average in the literature review. Uncertainties are in general large.

Additional remarks

Since battery units are highly modular and equipment is the main cost of a full installation, a close to linear scaling in total cost vs. installation size is expected from a technological point of view. Significant financial benefits from increasing installation sizes will rely on negotiations with the manufacturer.

Even though Na-NiCl₂ batteries have high commercial potential, rapid cost reduction of alternative storage solutions, e.g. Li-ion batteries could halt commercial deployment and technological development of Na-NiCl₂ batteries. This can prevent Na-NiCl₂ batteries from reaching full commercial potential.

Quantitative description

Assumptions for prediction of development are discussed above.

Technology	Na-NiCl ₂ battery									
	2015	2020	2030	2050	Uncertainty (2020)		Uncertainty (2050)		Note	Ref
Energy/technical data					Lower	Upper	Lower	Upper		
Form of energy stored	Electricity									
Application	System, power- and energy-intensive									
Energy storage capacity for one unit (MWh)	3.43	4.15	4.15	4.15	3.11	5.19	3.11	5.19	A,B,P	[12]+[11]
Output capacity for one unit (MW)	1.13	1.2	1.2	1.2	0.90	1.50	0.90	1.50	A,B,P	[12]+[11]
Input capacity for one unit (MW)	0.42	0.45	0.45	0.45	0.34	0.56	0.34	0.56	C,P	[34]+[8]
Round trip efficiency DC(%)	87	87	87	87	81	93	83	95	D	[4]+[7]; [31]
- Charge efficiency (%)	-	-	-	-	-	-	-	-		
- Discharge efficiency (%)	-	-	-	-	-	-	-	-		
Energy losses during storage (%/day)	0	0	0	0	0	15	0	15	E,P	[35]+[5];[31]
Forced outage (%)	0	0	0	0	0	2	0	2	F,P	[8]
Planned outage (weeks per year)	0	0	0	0	0	0	0	0	F,P	[8]
Technical lifetime (years)	15	17	23	23	9	25	12	33		[28]+[8];[30]+[32]+[31]
Construction time (years)	0.5	0.5	0.5	0.5	0.2	2.0	0.2	2.0	G,P	[11]
Regulation ability										
Response time from idle to full-rated discharge (sec)	0.02	0.02	0.02	0.02	0.001	0.02	0.001	0.02		[10]/[4]+[33]
Response time from full-rated charge to full-rated discharge (sec)	0.5	0.5	0.5	0.5	0.001	0.5	0.001	0.5	H,P	[4]
Financial data										
Specific investment (M€2015 per MWh)	1.0	0.42	0.26	0.23	0.32	0.53	0.18	0.30	I, J	[12]+[28]; [30]+[31]
- energy component (M€/MWh)	0.76	0.26	0.14	0.11	0.21	0.32	0.09	0.14	K	[12]; [31]
- capacity component (M€/MW)	0.48	0.41	0.33	0.33	0.30	0.58	0.25	0.47	L	[12]; [31]
- other project costs (M€/MWh)	0.08	0.03	0.02	0.02	0.03	0.04	0.01	0.02		[12]
Fixed O&M (% total investment)	1.5	1.5	1.5	1.5	0.9	2.0	0.9	2.0	M	[29]+[28]+[27]
Variable O&M (€2015/MWh)	0.6	0.6	0.6	0.6	0.4	2.1	0.4	2.1	N	[29]
Technology specific data										
Alternative investment cost (M€2015/MW)	3.0	1.4	0.9	0.8	1.1	1.8	0.6	1.0	I	[12]+[28]
Lifetime in total number of cycles	4500	4500	4500	4500	1500	11300	1500	11300	O	[4]+[8];[30]+[32]
Specific power (W/kg)	16	16	16	16	12	20	12	20	O,P	[8]
Power density (W/m ³)	9350	9350	9350	9350	7012	11687	7012	11687	O,P	[8]
Specific energy (Wh/kg)	56	56	56	56	42	70	42	70	O,P	[3]
Energy density (Wh/m ³)	32700	32700	32700	32700	24525	40875	24525	40875	O,P	[3]

- A. Italian batteries (Codrongianos (Sardinia) and Ciminna (Sicily)) used as standard.
- B. Highly modular technology type with near linear scaling between total cost and installation size. Power and storage capacity cannot be varied independently.
- C. Can fast recharge with rate identical to discharge rate. Standard charge/discharge time is 8/3 h.
- D. Efficiency varies depending on use. Loss due to balance of system is approximately 2 % higher than for Li-ion batteries with similar PCS equipment [7]
- E. During intended continuous operation, Ohmic losses maintain the temperature of the battery. Losses are thus included in round trip efficiency. No electrical self-discharge. Heat losses during idle periods on the order of 0.5 %/h discussed above. IRENA finds self-discharge per day to vary between 0.1 % and 15 % depending on unit and use [31]
- F. Highly reliable and with no downtime required for maintenance during lifetime according to manufacturer.
- G. Can be down to 2 months.
- H. Measurement. Possibly limited by PCS.
- I. For 2015, the specific storage to power capacity ratio is set to the average value for Italian “Terna Storage Lab” batteries. For future installations, the 4150 kWh and 1200 kW system is assumed.
- J. Development rates from IRENA are used for prediction of future cost [30]
- K. Includes “Batteries” from reference [12]
- L. Includes “PCS-SCI”, “Transformer”, “Auxiliary equipment”, “Switching and actuating equipment”, and “System Controls & Instrumentation (SCI)” from reference [12].
- M. Assumed similar to Na-S batteries in good agreement with data from EPRI [28]
- N. Highly uncertain. Average value given. Reported in range 0.38 to 2.1 [29]
- O. Data for Energy Spring 164 system from FZSoNick. Irena do not expected improvements on cell level. Improvements on installation level might occur [32]
- P. Uncertainties are based on a qualified guess.

References

- [1] J. L. Sudworth and R. C. Galloway, "SECONDARY BATTERIES – HIGH TEMPERATURE SYSTEMS | Sodium–Nickel Chloride," in *Encyclopedia of Electrochemical Power Sources*, 2009, pp. 312–323.
- [2] Z. Yang et al., "Electrochemical Energy Storage for Green Grid," *Chem. Rev.*, vol. 111, no. 5, pp. 3577–3613, May 2011.
- [3] X. Lu, G. Li, J. Y. Kim, J. P. Lemmon, V. L. Sprenkle, and Z. Yang, "A novel low-cost sodium–zinc chloride battery," *Energy Environ. Sci.*, vol. 6, no. 6, p. 1837, 2013.
- [4] R. Benato et al., "Sodium nickel chloride battery technology for large-scale stationary storage in the high voltage network," *J. Power Sources*, vol. 293, pp. 127–136, 2015.
- [5] G. L. Soloveichik, "Battery Technologies for Large-Scale Stationary Energy Storage," *Annu. Rev. Chem. Biomol. Eng.*, vol. 2, pp. 503–27, 2011.
- [6] B. Parkhideh, "Project : Storage Technologies for Hybrid Electric Buses - Subject : ZEBRA Battery," 2006.
- [7] M. Pietrucci, "Progetti Pilota Power Intensive: Descrizione degli impianti e delle tecnologie," 2017.
- [8] FZSoNick, "DATASHEETS," 2017. [Online]. Available: <http://www.fzsonick.com/en/emea/energy-storage/prodotti/spring,-mod-164,-324.aspx>.
- [9] M. Hosseinifar and A. Petric, "Effect of High Charge Rate on Cycle Life of ZEBRA (Na/NiCl₂) Cells," *J. Electrochem. Soc.*, vol. 163, no. 7, pp. A1226–A1231, 2016.
- [10] T. V Rachel Carnegie Douglas Gotham David Nderitu Paul Preckel, "Utility Scale Energy Storage Systems," 2013.
- [11] "DOE Global Energy Storage Database." [Online]. Available: <https://www.energystorageexchange.org/>. [Accessed: 29-Mar-2017].
- [12] R. Benato, G. Bruno, F. Palone, R. Polito, and M. Rebolini, "Large-Scale Electrochemical Energy Storage in High Voltage Grids: Overview of the Italian Experience," *Energies*, vol. 10, no. 1, p. 108, Jan. 2017.
- [13] NGK Insulators LTD, "Case Studies." pp. 1–13, 2016.
- [14] NGK Insulators LTD, "The World's Largest NAS Battery Installation Commences Operation Short Installation Period Achieved through Containerized, Compact Format," 2016. [Online]. Available: <http://www.ngk.co.jp/english/news/2016/0303.html>.
- [15] M. Andriollo et al., "Energy intensive electrochemical storage in Italy: 34.8 MW sodium-sulphur secondary cells," *J. Energy Storage*, vol. 5, pp. 146–155, Feb. 2016.
- [16] NGK Insulators LTD, "Structure of NAS Energy Storage System," 2016. [Online]. Available: <https://www.ngk.co.jp/nas/specs/>.
- [17] K. Bradbury, "Energy Storage Technology Review," *A Br. Introd. to Batter.*, no. September, pp. 1–33, 2010.

- [18] IEC, "Electrical Energy Storage," 2011.
- [19] A. Colthorpe, "NGK's NAS sodium sulfur grid-scale batteries in depth E," Energy Storage News, 2017.
- [20] C.-H. Dustmann and A. Bito, "SECONDARY BATTERIES – HIGH TEMPERATURE SYSTEMS | Safety," in Encyclopedia of Electrochemical Power Sources, 2009, pp. 324–333.
- [21] R. C. Galloway, -Mes-Dea Sa, and C.-H. Dustmann, "ZEBRA Battery -Material Cost Availability and Recycling," vol. 1519, 2003.
- [22] H.-J. Chang, N. L. Canfield, K. Jung, V. L. Sprenkle, and G. Li, "Advanced Na-NiCl₂ Battery Using Nickel-Coated Graphite with Core– Shell Microarchitecture."
- [23] Fred Lambert, "Breakdown of raw materials in Tesla's batteries and possible bottlenecks | Electrek," Electrek, 2016. [Online]. Available: <https://electrek.co/2016/11/01/breakdown-raw-materials-tesla-batteries-possible-bottleneck/>. [Accessed: 12-Sep-2017].
- [24] S. Longo, V. Antonucci, M. Cellura, and M. Ferraro, "Life cycle assessment of storage systems: the case study of a sodium/nickel chloride battery," J. Clean. Prod., vol. 85, pp. 337–346, 2014.
- [25] O. Teller et al., "Joint EASE/EERA Recommendations for a European Energy Storage Technology Development Roadmap Towards 2030," 2013.
- [26] X. Lu et al., "Liquid-metal electrode to enable ultra-low temperature sodium–beta alumina batteries for renewable energy storage," Nat. Commun., vol. 5, pp. 5884–5901, Aug. 2014.
- [27] J. E. Al Carlsson, "ETRI 2014 - Energy Technology Reference Indicator projections for 2010-2050," 2014.
- [28] G. Huff et al., "DOE/EPRI 2013 electricity storage handbook in collaboration with NRECA," Rep. SAND2013- ..., no. July, p. 340, 2013.
- [29] B. Zakeri and S. Syri, "Electrical energy storage systems: A comparative life cycle cost analysis," Renew. Sustain. Energy Rev., vol. 42, pp. 569–596, 2015.
- [30] K.-P. Kairies, "Battery storage technology improvements and cost reductions to 2030: A Deep Dive," Int. Renew. Energy Agency Work., 2017.
- [31] IRENA, "Electricity storage and renewables: Costs and markets to 2030 - Cost-of-service tool. Version 1.0," 2017.
- [32] P. Ralon, M. Taylor, and A. Ilas, Electricity storage and renewables: costs and market to 2030, no. October. 2017.
- [33] L. Sigrist and E. Peirano, "E-Highway2050: Battery Storage Technology Assessment," in WP3 workshop April 15th, 2014.
- [34] J. Garche and C. K. Dyer, Encyclopedia of electrochemical power sources. Academic Press, 2009.
- [35] H. Chen, T. N. Cong, W. Yang, C. Tan, Y. Li, and Y. Ding, "Progress in electrical energy storage system: A critical review," Prog. Nat. Sci., vol. 19, no. 3, pp. 291–312, 2009.