

ENERGINET - DANISH OFFSHORE WIND 2030

Burial Assessment Study

North Sea I - Nymindegab North Export Cable Route



P2719_R6490_Rev1 | 21 August 2024

Intertek Metoc

Exchange House, Station Road, Liphook, Hampshire GU30 7DW, United Kingdom

DOCUMENT RELEASE FORM

Energinet - Danish Offshore Wind 2030

P2719_R6490_Rev1

Burial Assessment Study

North Sea I - Nymindégab North Export Cable Route

Author/s

Mitch Foster, Christopher Carroll, Joe Freaan, Harry Haspell

Project Manager



Stephane Theurich

Authoriser



Andrew Page

Rev No	Date	Reason	Author	Checker	Authoriser
Rev 0	07/08/2024	Original issue	HSH	SLT	APA
Rev 1	21/08/2024	Updated following client comments	SLT	APA	APA

Intertek Metoc is the trading name of Metoc Ltd, a member of the Intertek group of companies.

SUMMARY

Intertek Metoc (Intertek) has been commissioned by Energinet Eltransmission A/S (the Client) to undertake a Burial Assessment Study (BAS) for the North Sea Nymindégab North Export Cable Route.

Intertek has reviewed available cable burial technologies and methodologies that can be considered as potential solutions for the Kattegat export cable and has undertaken a burial assessment study using survey data results supplied by the Client.

Intertek has reviewed geophysical/geotechnical data (from the 2023/2024 survey undertaken by GeoXYZ) and identified different geological zone along the route. Burial tools and trenching methods have then been assessed for each of these zones.

Table S-1 highlights the burial tool trenching methods and their likely performance along the route.

Table S-1 Burial Tool Assessment Results

Trenching Method	Trenching Method Performance
Low Power ROV	Low performance in one zone where non jettable soils are present within trench depth.
High Power ROV	High performance in all zones as soils within operational limits are present.
Jet Sled	Moderate performance expected in two zones with medium - high strength clay.
Tractor Jetting	Low performance in most zones due to sinkage in very soft seabed.
Plough	High Performance in all zones as soils within operational limits are present.
Chain Cutting	Low performance in most zones due to sinkage in very soft seabed.

For the North Sea Nymindégab North cable route the high powered Jetting ROV should achieve the depth of lowering in zones 4 to 28. For zone 1 to 3, as water depth <10m, specialist nearshore jetting tools would be recommended. Cable ploughs should achieve depth of lowering in all zones.

CONTENTS

	DOCUMENT RELEASE FORM	I
	SUMMARY	II
	ABBREVIATIONS	I
1.	INTRODUCTION	1
1.1	Scope	1
1.2	Background	1
1.3	Purpose of this Study	2
1.4	Relevant Data used in Present Study	4
1.5	Definition of Trenching Parameter	4
1.6	Limitations	5
1.7	Report Structure	6
2.	MARKET ASSESSMENT - CABLE BURIAL TECHNOLOGIES & METHODS	7
2.1	BAS Methodology	7
2.2	Cable Burial Methods	7
2.3	Market Assessment of Cable Trenching Tools	17
3.	GEOLOGICAL ASSESSMENT	20
3.1	Introduction	20
3.2	Methodology for Geological Assessment/Groupings	20
3.3	Geological Zones	21
3.4	Pre-installation Activities	22
3.5	Crossing of Third-party Assets	22
4.	BURIAL ASSESSMENT STUDY	23
5.	CONCLUSIONS	26
5.1	Burial Tool Assessment Results	26
5.2	Potential Contractors	26
	REFERENCES	28
APPENDIX A	Market Assessment – Available Tools	A-1
APPENDIX B	Burial Assessment Table	B-1

LIST OF TABLES AND FIGURES

Tables

Table S-1	Burial Tool Assessment Results	II
Table 1-1	North Sea Nymindégab North Export Cable Route	2
Table 1-2	Data Used	4
Table 2-1	Market Assessment - Summary of Tool Types	18
Table 3-1	Granular Material Density Classification	20
Table 3-2	Cohesive Material Intrinsic Strength	20
Table 3-3	Geological Zones	21
Table 4-1	Performance Ratings	23
Table 4-2	BAS Overview Table	24
Table 5-1	Burial Tool Assessment Results	26
Table 5-2	Contractors	26
Table B-1	Granular Material Density Classification	B-1
Table B-2	Cohesive Material Intrinsic Strength	B-1
Table B-3	Performance Ratings	B-1

Figures

Figure 1-1	Danish Offshore Wind 2030 Investigated Offshore Wind Farm Areas and the Associated Export Cable Corridors (1500m wide)	1
Figure 1-2	Export Cable Route Overview	3
Figure 1-3	Definition of Burial Terms used in Report	5
Figure 2-1	Tool Feasibility Depending on Soil Conditions	7
Figure 2-2	Example of free-flying ROV Jet Trencher	9
Figure 2-3	Example of Tracked ROV Jet Trencher	10
Figure 2-4	Example of Jet Sled Trencher	11
Figure 2-5	Example of Tractor Jet Trencher	12
Figure 2-6	Example of Mechanical Cutting Trencher	13
Figure 2-7	Example of Cable Plough	14
Figure 2-8	Jet trencher pitch and roll abilities	16
Figure 2-9	Cable Plough	16
Figure 2-10	Vessel Fed Jetting	16

ABBREVIATIONS

BAS Burial Assessment Study	m Meter
CBRA Cable Burial Risk Assessment	m/hr Meter per hour
CLB Cable Lay Barge	MW MegaWatt
CPT Cone Penetrometer Test	OD Outer Diameter
DoL Depth of Lowering	PLB Post Lay Burial
D_r Relative Density	PLGR Pre Lay Grapple Run
HVDC High Voltage Direct Current	PSD Particle Size Distribution
HP Horsepower	RAG Red Amber Green
HP High Power	RMDOL Recommended Minimum Depth of Lowering
HP Horsepower	ROV Robotic Operated Vehicle
KP Kilometre Point	SLB Simultaneous Lay and Burial
km Kilometre	TDOL Target Depth of Lowering
KW KiloWatt	ToC Top of Cable
kPa Kilo Pascal	TTD Target Trench Depth
LP Low Power	VC Vibro Core
MBR Minimum Bend Radius	
MPa Mega Pascal	

1. INTRODUCTION

1.1 Scope

Intertek Metoc (Intertek) have been commissioned by Energinet Eltransmission A/S to undertake a Burial Assessment Study (BAS) for the North Sea Nymindégab North export cable route.

This report is limited to a review of preliminary geophysical and geotechnical survey data and reports from the 2023/2024 survey undertaken by GeoXYZ and builds on work completed by Intertek for the Cable Burial Risk Assessment (Ref P2719_R6455_Rev1).

1.2 Background

Denmark is developing further offshore wind energy areas and related infrastructure in the Danish North Sea, the inner Danish Waters, and the Danish Baltic Sea as per a decision made by the Danish Parliament in 2022. It is understood that five main subsea cable connections will connect the offshore wind energy in the areas of North Sea I, Kattegat, and Kriegers Flak II to the Danish mainland. There will be three cable routes from North Sea I, one from Kattegat, and one from Kriegers Flak II as illustrated in the below overview map.

Figure 1-1 Danish Offshore Wind 2030 Investigated Offshore Wind Farm Areas and the Associated Export Cable Corridors (1500m wide)

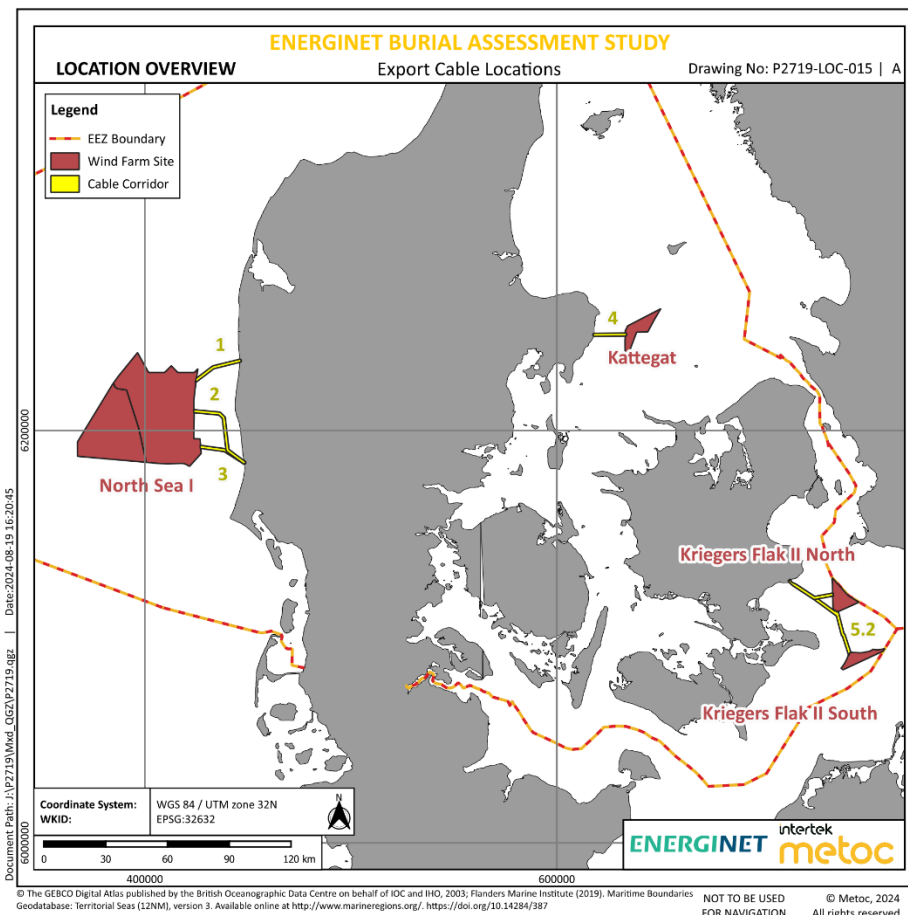

It is understood that the width of the corridors for the route survey is 1500 m. Energinet anticipates that at least two cables are planned for each corridor. The length of the routes is detailed below in Table 1-1.

Table 1-1 North Sea Nymindégab North Export Cable Route

No.	Cable Route	Length [km]
2	NS I – Nymindégab North	Ca. 41 km

An overview of the route is provided below in Figure 1-2.

1.3 Purpose of this Study

The purpose of this report is twofold.

Firstly, to provide a review of available cable burial technologies that can be considered as potential solutions for the forthcoming project. A market assessment of different burial tools is presented.

Secondly, it will undertake a high-level burial assessment study of the North Sea Nymindégab North cable route using the geological groundmodel and route zonation. The study will recommend burial methodologies to achieve the target trench depth derived from the cable burial risk assessment study.

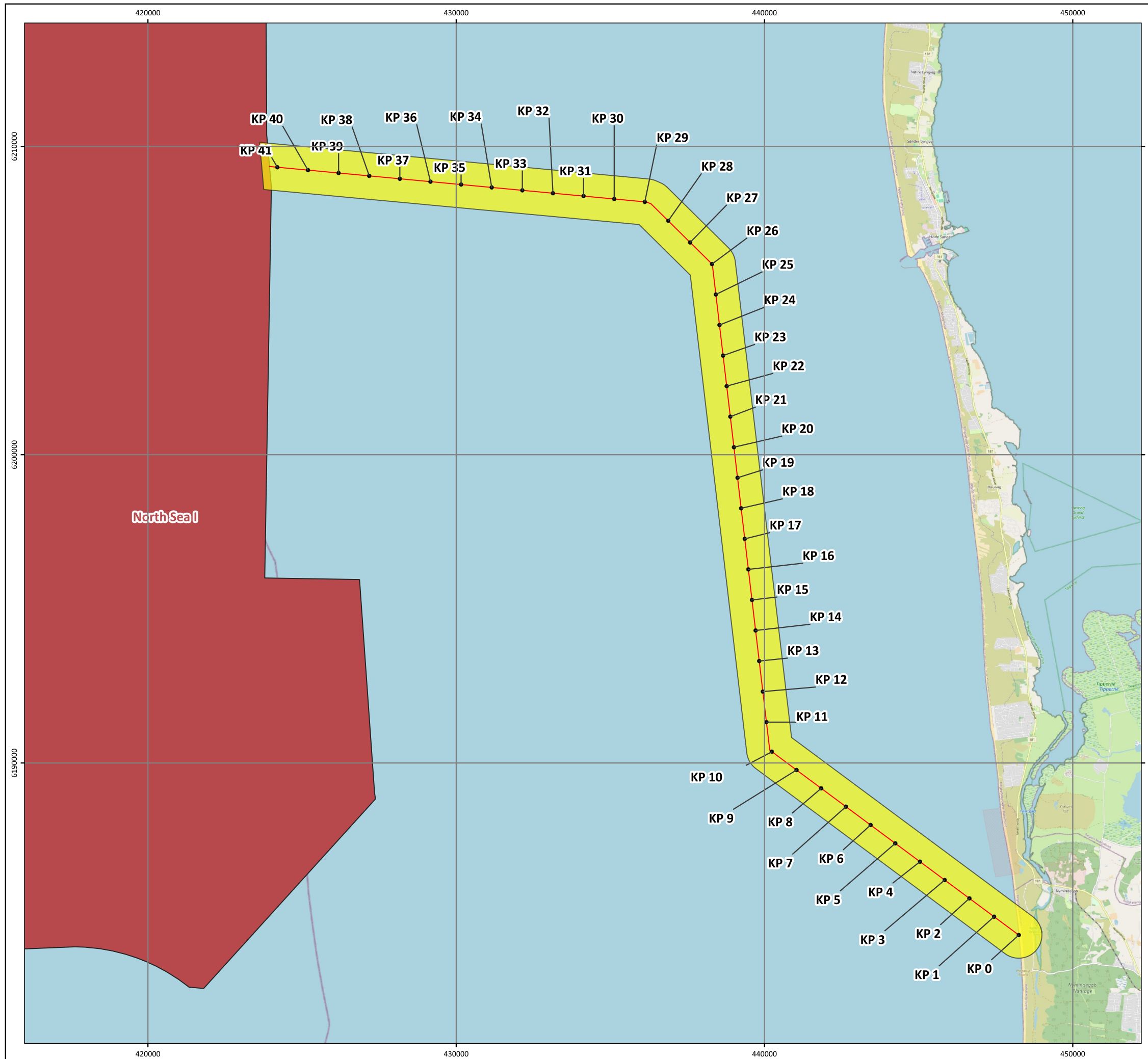

CABLE BURIAL RISK ASSESSMENT NORTH SEA I - NYMINDEGAB NORTH

LOCATION OVERVIEW

Cable Route

Drawing No: P2719C-LOC-001

B

Legend

- KP
- Cable Route
- Cable Corridor (1.5km)
- Wind Farm Site



NOT TO BE USED FOR NAVIGATION

Date	2024-06-20 16:38:46
Coordinate System	ETRS89 / UTM zone 32N
WKID	EPSG:25832
Scale @A3	1:125,000
Data Sources	ENERGINET; NUTS
File Reference	J:\P2719\Mxd_QGZ\P2719C\01_LOC \P2719C_LOC.qgz
Created By	Lewis Castle
Reviewed By	Emma Langley
Approved By	Stephane Theurich

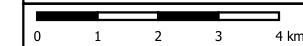

© Metoc, 2024
All rights reserved

1.4 Relevant Data used in Present Study

Cable Burial Risk Assessment (CBRA) for the route Ref P2719_R6455_Rev1: The study provides a comprehensive and probabilistic assessment of anchor risks along the route using location specific vessel data together with additional layers of conservatism to determine the depth of lowering of the cable bundle along the route to achieve a return period of interaction greater than 10,000 years.

Data obtained from the geophysical and geotechnical campaigns and other relevant data sources are presented in **Table 1-2** below.

Table 1-2 Data Used

Data Type	Name	Information
Survey Bathymetry	NS_ECR2_MBES_XYZ_025m.xyz	0.5m resolution bathymetry over a 1500m survey corridor
	NS_ECR2_CONTOURS_LIN.shp	0.5m bathymetry contours over the extent of the survey corridor
Open-Source Bathymetry	EMODnet Bathymetry	EMODnet Digital Terrain Model (DTM) is generated for European sea regions from selected bathy survey data sets (1975 to 2013 using SBES & MBES) and composite DTMs, while gaps with no data coverage are completed by integrating the GEBCO Digital Bathymetry. 200m Resolution
AIS Data	Intertek_P2671_AIS_Data	5-minute time series data of shipping from 07/02/2023 to 06/02/2024 +/- 5nm either side of the route centreline provided by Exmile Solutions Ltd
Geology	Shallow Geological Isopach	Draft shallow geological isopach interpreted from sub-bottom profiler data and correlated with side scan sonar imagery and bathymetric digital terrain model data
Geotechnical Samples	Vibrocore, Cone Penetrometer Tests and grab sample logs	Draft geotechnical sample logs from Vibrocore (VC), Cone Penetration Test (CPT) and Grab Sample (GS)
Desktop Study	Screening of seabed geological conditions for the offshore wind farm area North Sea Nymindgab North and the adjacent cable corridor area	Geological desktop study of the area undertaken by GEUS
CBRA	P2719_R6455_Rev1	Cable Burial Risk Assessment

1.5 Definition of Trenching Parameter

Intertek has used the Carbon Trust’s definition of Depth of Lowering (DOL) for this study. This is illustrated in **Figure 1-3**.

Figure 1-3 Definition of Burial Terms used in Report

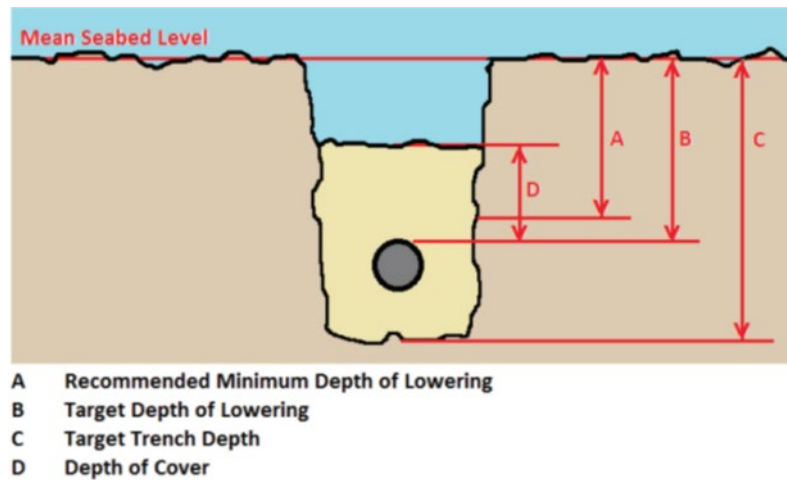

Recommended Minimum Depth of Lowering (RMDOL)

This is the minimum DOL recommended for protection from the external threats. It is the direct output of the fishing risk assessment and the probabilistic anchor risk assessment and includes a factor of safety (FoS).

Target Depth of Lowering (TDOL)

This is the depth that will be specified as the target depth to the cable installation contractor. TDOL is a depth which makes best use of what is achievable by industry standard burial tools to gain additional depth beyond RMDOL without incurring a step change in costs. Target DOL is also a practical application of depth which considers the effect burial depth has on tool stability.

Target Trench Depth (TTD)

This is the trench depth cable installation contractors determine is required to meet TDOL. This is driven by cable properties and the selected trenching tool and is usually the diameter of the cable plus between 0.1 m and 0.4 m beyond the TDOL.

Depth of Cover (DoC)

The thickness of material on top of the cable after trenching. DoC can vary depending on the sediment type and tidal cycles I.E in areas of fine sand or in stormy locations

1.6 Limitations

This study uses the geological ground model and zonation interpreted for the Cable Burial Risk Assessment using the data listed in **Table 1-2** provided at the time of analysis. It is important to note that, as of the completion of this analysis and the writing of this report, the geophysical interpretation, geotechnical factual and integrated reports were not available from the survey contractor. Additionally, no alignment charts were available. Intertek's analysis of the soils conditions along the route is based solely on the analysis of the draft geotechnical coring and cone penetrometer logs. This study provides a high-level assessment of the tool type abilities in the soil conditions present along the route. More detail on the confidence levels and the number of passes to achieve the Depth of Lowering (DoL) would need to be tool specific and require all the results from the geotechnical lab testing.

An assessment of depth of cover was beyond the scope of this study. This would require a separate study which would be tool specific and require all the results from the geotechnical lab testing and metocean results to determine bedload transport along the route.

1.7 Report Structure

The structure of this report is as follows:

- Section 1 – Introduction
- Section 2 – Market Assessment of Cable Burial Technologies and Methods
- Section 3 – Geological Assessment
- Section 4 – Burial Assessment Study
- Section 5 – Conclusions
- Appendix A – Available tools
- Appendix B – Intertek BAS Table

2. MARKET ASSESSMENT - CABLE BURIAL TECHNOLOGIES & METHODS

2.1 BAS Methodology

Intertek have conducted a thorough selection process for trenching tools based on previous experience and literature reviews, focusing on capability and suitability for excavating the soil conditions indicated to be present along the proposed route. The process includes a route appraisal considering factors like water depth, soil types, and the required DoL based on the CBRA.

For trenching the most important parameters for selecting the most suitable burial method and predicting trencher performance are the undrained shear strength of clays (S_u), and for sands; the grain size (PSD), and relative density (D_r).

The BAS table is the result of an in-depth review of the geophysical and geotechnical data available along the route, categorising it into zones of similar soils, considering the required DoL from the CBRA. A Red Amber Green (RAG) rating is applied to each zone indicating the suitability and performance of the various burial methods.

This report includes an illustrative BAS table and summarises the findings, providing a comprehensive overview of trenching methods, tool selection, and burial assessment across different zones.

2.2 Cable Burial Methods

The principal burial methods for submarine cables fall into three categories: water jetting, mechanical cutting and ploughing. The properties of the soil through which the trench is to be excavated is critical for all three methods, as each uses a different technique. The plough is equipped with a share, that shears through the soil displacing it to form a trench, the water jet tools employ jet nozzles to erode or liquify the soil and mechanical cutters rely on hardened picks to cut the soil or weak rock. **Figure 2-1** (Ref: Brunning et al, 2014. OTC 24833,) shows how the applicability of the three excavation categories varies with changing soil conditions.

Figure 2-1 Tool Feasibility Depending on Soil Conditions

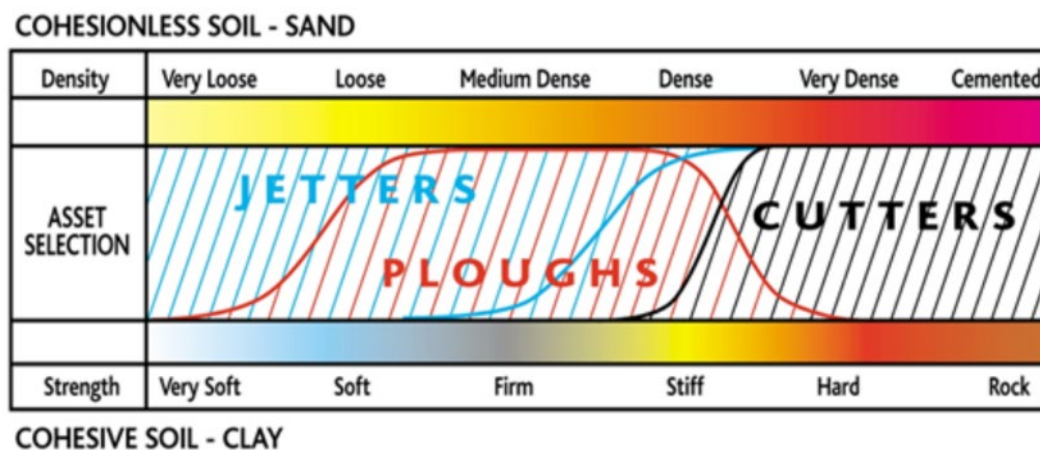

Each method has their advantages and disadvantages depending on soil type and the cable installation method, either simultaneous lay and burial (SLB) or post lay burial (PLB). Whilst it is possible to select a different tool optimised for each soil zone identified in the BAS, this approach is often neither practical nor economical for the installation contractor. Consequently, a contractor will endeavour to

offer just one tool capable of trenching in all of the soil types present along the route, ideally in a single pass, which may result in a compromise on tool selection and a risk of not achieving the required DoL. Where the required DoL is not achieved in a single pass remedial works are often required, which can include further trenching passes (if feasible), or additional protection such as matting or rock installation. This report only considers the primary trenching method and does not consider remedial works.

The three main categories of trenching tools are as follows.

2.2.1 Jetting Tools

Jet trenchers all have the same common design philosophy, based on delivering high pressure and/or high-volume water through a series of nozzles arranged along the forward face of a pair of swords placed either side of the cable, without physically interacting with it.

Water pumps to supply the swords can either be located on the deck of the vessel, pumping water down to the trencher on the seabed which limits operation depth to <20-30m, or the trencher is equipped with submersible pumps enabling them to operate in water depths of 10m to 1000m.

Jet trencher swords are available in different lengths, typically between 1.0m and 3.0m long which can be changed offshore, depending on the target trench depth (TTD). Jetting swords are generally highly flexible in terms of nozzle configuration which can also be optimised based on the TTD and soil conditions.

In sands, the jetting process fluidises the soil turning it into a slurry through which the relatively heavy cable sinks to the base of the trench. For this process to occur the cable must have a specific gravity >1.8, and is therefore a key parameter to ensure that the cable does not 'float' within the jetted trench.

In order for the cable to sink to the base of the trench the soil has to remain fluidised until the cable touches down. This is a function of the trencher speed, grain size, trench depth and cable parameters - Specific Gravity (SG) & Minimum Bend Radius (MBR). Issues can arise where coarse grained soils (gravels & cobbles) are present, as these tend to settle out before the cable touches down, resulting in reduced depth of lowering.

In clays, the jetting process cuts through the clay and spoil is carried out of the trench by the flow of water. Efficient and economical jetting in clays is limited to undrained shear strengths of up to 40 kPa for low powered tools, but a few high-powered tools can jet in clays up to 120-150kPa. Approaching these upper limits jetting becomes more difficult, resulting in reduced speed and higher forces on the swords which must be retracted to avoid damage, resulting in reduced DOL.

Jet trenchers are available in several formats suitable for both shallow and deep water, SLB or PLB operations. Four primary types are discussed in detail below.

2.2.1.1 Free-flying ROV Jet Trenchers (<800HP)

Free-flying ROV's are light weight (neutrally buoyant) low powered jet trenchers suited to burying small diameter cables (typically <100mm OD) in loose to medium dense sands and extremely low to low strength clays, typically up to a maximum of 40kPa. They are used for PLB trenching operations with the advantage that due to their size they can be mobilised on a variety of vessels from barges to supply vessels and are capable of performing multiple passes. Disadvantages are that they are limited on soil strength and susceptible to currents, especially if operating broadside to the current which can result in trenching having to be suspended or under extreme circumstances, 'blown' off the cable, risking damage to both the trencher and cable.

Figure 2-2 Example of free-flying ROV Jet Trencher



Jan De Nul – PT1

2.2.1.2 Tracked / Skid ROV Jet Trenchers (>1000HP)

Tracked or skid mounted ROV's are ballasted to be negatively buoyant (typically 500 – 1000kg) when trenching ensuring that they remain stable on the seabed. Skid mounted ROV's rely on thrusters to push the ROV along, whereas tracked ROV's use hydraulic motors to drive the tracks. Tracked ROV's are often preferred as it enables the pilots to steer the ROV and control trenching speed, especially in high currents.

Most jet trenchers in this class have installed power of 1000 to 1600 HP to drive both LP/HP subsea water pumps, motors for tracked vehicles, and thrusters for positioning/aligning the trencher when landing astride the product. They are capable of trenching products from 100mm to 900mm in diameter and trench depths up to 3.0m.

Due to the increased power, they can trench loose to very dense sands/gravels, and extremely low to high strength clay typically up to 75kPa, although 1500HP trenchers have jetted in 120-150kPa clay depending on the product specification and target trench depth.

They are used for PLB trenching operations with the advantage that they are extremely flexible, can adjust to different required DoL's along the route and can perform multiple passes. Due to their size and complexity, they are typically permanently mounted on a Trencher support vessel as a dedicated

launch and recovery system (LARS) is required often enabling the trencher to operate in sea states up to Beaufort¹ 5/6.

Figure 2-3 Example of Tracked ROV Jet Trencher



DeepOcean -UT-1

2.2.1.3 Jet Sled Trenchers

Sled based trenchers are typically used for SLB cable installations where they are deployed from the lay vessel and towed behind in the same way as a plough. They differ slightly from other jetting machines as the cable is loaded into the jet sled and positively placed at the required depth with a depressor. However, instead of a plough share the sled has a stinger with a series of nozzles arranged along the forward face such the stinger acts as a single jet sword. Water supply can be provided from deck pumps for shallow water routes, or subsea pumps for deeper water. Jet sleds are typically light weight, basic tools with minimal instrumentation, and are ideally suited to shallow water routes, with shallow TTD in uniform very loose to medium dense sands, or low strength clays. Where very dense sands or higher strength clays are expected the required DoL is unlikely to be achieved. As jet sleds are single pass tools their selection requires high level of confidence that the required DoL can be achieved along the entire route.

¹ The Beaufort scale is a system used to estimate wind speed based on observed conditions. Beaufort 5, known as a fresh breeze, has wind speeds of 17-21 knots (19-24 mph or 29-38 km/h), causing small trees to sway and moderate waves with many whitecaps at sea. Beaufort 6, a strong breeze, has wind speeds of 22-27 knots (25-31 mph or 39-49 km/h), making large branches move, whistling heard in telephone wires, and umbrellas difficult to use, with larger waves and extensive whitecaps at sea.

Figure 2-4 Example of Jet Sled Trencher



Asso HydroPlough

2.2.1.4 Tractor Jet Trenchers / Hybrid

Tractor based trenchers are used for PLB cable installations. They can be jetting only or also equipped with a chain cutter as discussed in **Section 2.2.2**. As Tractor jet trenchers are heavy, they ideally require a firm seabed to prevent sinkage although some models can be fitted with wider tracks and buoyancy to reduce the bearing pressure. The jetting tool is usually located on rear mounted arm which can be adjusted vertically to vary the TTD and is equipped with an integrated depressor to positively place the cable at the required depth. Tractor jet trenchers also offer a more stable platform with good traction on firm seabed and are unaffected by high currents unlike ROV based trenchers which may need to stop. As with all mechanical trenchers they have high maintenance requirements compared with ROV jet trenchers.

Where Tractor trenchers can operate in in Jetting or cutting mode or both simultaneously, they are referred to as Hybrid trenchers.

Figure 2-5 Example of Tractor Jet Trencher

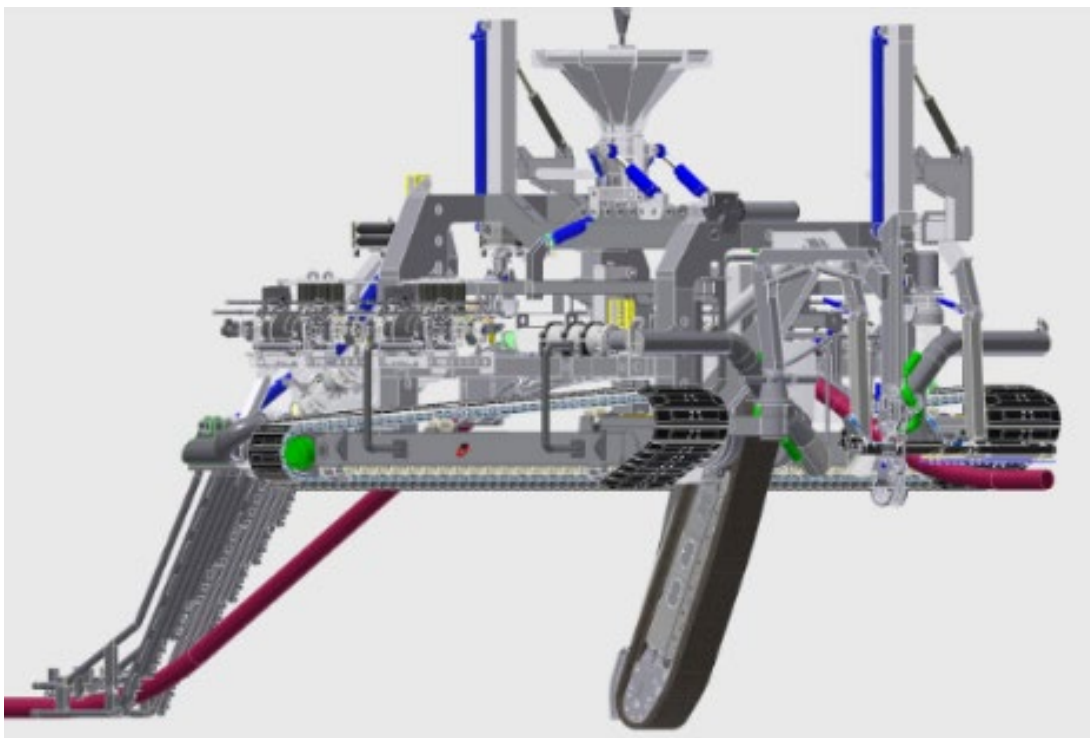

Boskalis CBT2400

2.2.2 Mechanical Cutting Tools

Mechanical cutting tools physically excavate a trench using a series of picks mounted on either a boom mounted chain cutter, or a rock wheel. They are often also equipped with eductors or dredge pumps to remove spoil from the trench to prevent cut material settling out before the cable touches down.

Mechanical cutters are typically heavy tractor-based units weighing circa 40-70 Te in air, which require a large DP2 support vessel equipped with an A-frame for launch and recovery and a firm seabed to prevent sinkage. Chain cutters are available to cut trenches between 2.0m to 3.2m in depth, whereas rock wheels can typically trench up to 1.2m. Trench width is fixed, being determined by the width of the cutting tool. They have high maintenance requirements compared with other burial methods with the cutting chain or picks requiring frequent replacement.

Chain cutters are designed primarily for very dense sands and gravels, high strength clay and very weak rock, whereas rock wheels are designed exclusively for rock. The soils data indicates that rock is not present along the route, consequently rock wheels are not considered further. They are also sensitive to gravelly, cobbly soils that can jam the cutting chain or block the dredging heads, and sinkage / traction problems where extremely low to low strength clays or very loose sands are present at seabed.

Mechanical cutters are designed for PLB operations and only capable of performing a single pass. The vehicle has to lift and load the cable into a trough that passes over the top of cutter boom to protect it from damage, and as the machine moves forward the cable is then positively placed into the cut trench at the required depth by a rear mounted depressor. Cable diameter and MBR are therefore critical parameters to ensure that the cable can pass through the trencher without incurring damage.

Mechanical cutters are ideally suited to short sections of a route where non-jettable soils are present and can be used in conjunction with a HP ROV jet trencher to provide a seamless multi-method solution. Some High Powered ROV tracked trenchers have a 'cassette' system whereby a jetting

cassette can be swapped offshore for a cutting cassette or vice-versa enabling one chassis to perform both jetting and cutting. Hybrid jet/cutting tractors are also available which can provide simultaneous cutting and jetting providing the same solution.

Figure 2-6 Example of Mechanical Cutting Trencher

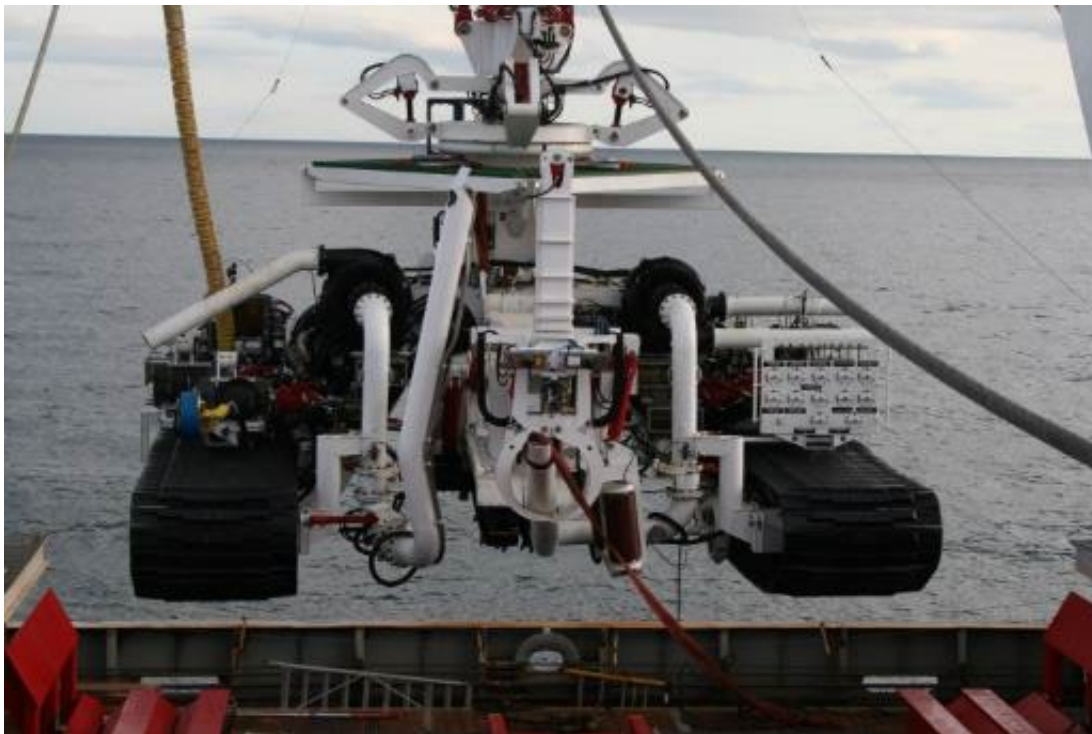

Helix Robotics I-trencher

2.2.3 Cable Ploughs

Cable ploughs are typically used for SLB cable installations and are therefore deployed from the stern of the lay vessel and towed behind. They are suitable for a wide range of soil conditions from extremely low to high strength clays and loose to dense sands/gravels.

Ploughs are capable of variable burial up to 3.0m below seabed in a single pass, as the cable must be loaded into a trough that passes over the share. This cuts a narrow vertical sided slot into which the cable is then positively placed at the required depth by an integral depressor. Cable diameter and MBR are therefore critical parameters to ensure that the cable can pass through the plough without incurring damage. Cable ploughs are designed based on a maximum tow force, typically between 50Te and 150Te, and the lay vessel must have the capability of providing this tow force in order to pull the plough along.

Tow force is a function of trench depth and soil conditions, with the undrained shear strength of clays and the grain size/relative density of sands being critical parameters. Where soils comprise fine very dense sand, or high strength clay, tow force may reach the upper limit. Under these circumstances, speed may slow to an unacceptable level, risking damage to the tow winch and/or plough. To reduce the tow force, the only option available is to reduce the trench depth, thus increasing the speed to an acceptable level. Some cable ploughs also have a jetting capability with subsea pumps providing high pressure water through a series of forward-facing nozzles arranged along the front face of the share. This can reduce tow forces by up to 20%.

Figure 2-7 Example of Cable Plough



Enshore PCP

2.2.4 Cable Properties

This burial assessment study has assumed the burial of a HVAC three core power cable with an outer diameter (OD) of 250 to 270mm.

It should be noted that the cable diameter must be added to the required DoL to acquire the TTD, which must be less than the maximum trench depth for the tool, as detailed in **Table 2-1**.

2.2.5 Seabed Slopes

In general cable burial can be undertaken either as a simultaneous lay and burial operation or as a two-phase methodology whereby the cable is laid onto the seabed first and then a secondary operation is undertaken for cable burial.

Potential installers will need to assess the bathymetry of the route and the properties of the sediment to determine the optimum installation solution as all trenching systems have limitation on the amount of inline slope angles and side slope angles that they can work on. Micro-routing and seabed preparation activities can be undertaken to ensure that the tool limitations are not exceeded.

In general, these machines are more sensitive to cross-slopes as the tendency to creep sideways down-slope over distance has to be resisted. Certain cable lay ploughs may be able to traverse side slope up to 10 degrees (direct communication from IHC). Seabed sediments and the actual tool and its track record will dictate if it is able to work on higher side slopes. Cable jet trenchers are able to traverse

side slopes up to 5 degrees as illustrated in **Figure 2-8**. Higher slide slopes may be possible depending on the soils and the tool.

Figure 2-8 Jet trencher pitch and roll abilities

Roll	0-5°	5-12°	12-20°	>20°
Pitch				
0-5°	G	Y	R	R
5-12°	G	Y	R	R
12-20°	Y	Y	R	R
>20°	R	R	R	R

Source: Personal communication from John Davies – Canyon Helix

2.2.6 Shallow Water Operations

Limitations to cable burial operations in shallow waters are two-fold. Limitations in the vessel’s ability to approach the coastline due vessel draught and water depths and limitations of trenching tools requiring enough water depth for manoeuvring or for jetting.

Vessel limitations

Cable Lay Vessels (CLV) are generally limited by their draught to 10 to 15m water depth contour (LAT). The CLV will generally position itself at this contour. For open cut trench shore crossing methodology the cable will be floated to the shore. If the shore crossing is being undertaken by a trenchless solution (e.g. horizontal directional drilling, direct pipe, microtunnel) then ideally the marine exit point should be as close to the 10m water depth contour to allow the cable to be buried from that exit point.

Trenching tool limitations

Shallow water operations are not suitable for all trenching tools. Free flying ROV jet trenchers will require a minimum water depth for manoeuvring. Trenching tools which rely on pumps to feed water for jetting systems such as jet trenchers or jetting ploughs will require at least 10m water depth (LAT) for the pumps to work effectively.

Cable ploughs and mechanical cutters can be operated from above the water line. Some specialist jetting tools have been modified so the pumps are fed water from the vessel.

Figure 2-9 Cable Plough



Source: Prysmian

Figure 2-10 Vessel Fed Jetting

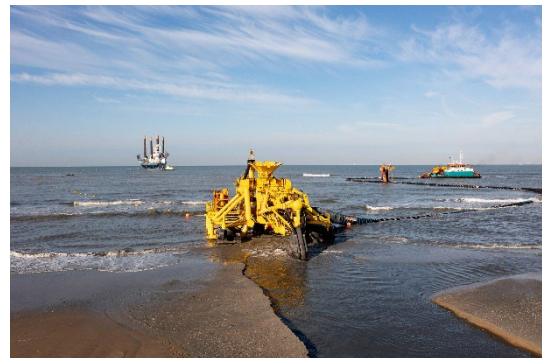

<Source: www.jandenul.com

2.3 Market Assessment of Cable Trenching Tools

A non-exhaustive listing of the different tools commercially available is presented in **Table 2-1** listed by Trenching Contractor in alphabetical order.

For power output of the tool the most commonly referenced unit is horsepower (HP). Where a manufacturer only provides the value in kiloWatts (kW) then a conversion to HP is provided on the basis of $1\text{kW} = 1.34102\text{ HP}$ with the original supplied kW value in brackets.

The maximum undrained shear strength (kPa) for clays that the tool is capable of excavating is included where provided. If this information is not included by manufacturer/operator, then it is stated as '-'.

Maximum trench depth that the tools can achieve is included where provided. However, this is subject to cable specification and soil conditions.

Appendix A present details of tools categorised into:

- **Jetting**
- **Cutting**
- **Cutting / Jetting**
- **Cutting & Jetting (Hybrid)**
- **Ploughing**
- **Ploughing & Jetting**

Table 2-1 Market Assessment - Summary of Tool Types

Tool Name	Tool Type	Method	Total Power (HP)	Max Water Depth (m)	Max Trench Depth (m)	Max Undrained Shear Strength (kPa)
AssoJet III - Mk 1	HP ROV - Tracked / skid	Jetting	970	1500	3.0	120 - 150
AssoJet III - Mk 2	HP ROV - Tracked / skid	Jetting	1160	1500	3.4	120 - 150
AssoTrencher IV - Mk12	Tractor	Cutting	1160	1500	2.3	3000
AssoTrencher IV - Mk9	Tractor	Cutting	1050	700	3.0	3000
AssoTrencher IV - Mk13	Tractor	Cutting	1160	800	2.3	3000.
AssoTrencher-V-Mk3	Tractor	Cutting / Jetting	710	100	2.4 / 3.4	3000 / 120
Asso Hydroplow	Jet sled	Jetting	-	150	2 / 3 / 4	120
Boskalis CBT2400	Tractor	Cutting & Jetting (+Hybrid)	2400	1000	3.3	-
Enshore PCP	Plough (130Te Tow force)	Ploughing	400	1500	2.4	300 - 600
Enshore - T1	Tractor	Jetting	697	1000	2.0	40 kPa
Enshore ENS1600	Tractor	Cutting & Jetting (+Hybrid)	1610	1500	3.2 / 5.0	1200 / 75
Deep Ocean UT1	HP ROV Tracked / Skid	Jetting	2816	1500	3	75 - 100
Deep Ocean T1000	HP ROV Tracked	Jetting	1000	2000	3	80
Global Marine – Atlas	LP ROV free flying	Jetting	400	2000	2	100
Global Marine – Hi Plough	Plough (80Te Tow Force)	Ploughing + jetting	670	2000	3.25	150
Helix Robotics - i-Trencher	Tractor	Cutting	1680	1500	2.7	600
Helix Robotics T1200	HP ROV -Tracked	Jetting	1200	3000	3	120
Helix Robotics T1500	HP ROV -Tracked	Jetting	1500	3000	3	150
Helix Robotics T1400	HP ROV - Tracked	Cutting & Jetting (+Hybrid)	1400	1500	2 / 3	250 / 100
Jan De Nul - PT1	HP ROV skid	Jetting	2000	2000	2.5	-
Jan De Nul - UTV1200	Tractor	Cutting / Jetting	1200	500	1.6 / 3	400 / 100

Tool Name	Tool Type	Method	Total Power (HP)	Max Water Depth (m)	Max Trench Depth (m)	Max Undrained Shear Strength (kPa)
Jan De Nul - Swordfish	Tractor	Cutting / Jetting	1600	500	2 / 3	400 / 125
JD-Contractor A/S Subjet III	LP ROV - Tracked	Jetting	400	200	1.8	-
LD Travocean - ROVJET 400 series	LP ROV Tracked / Free flying	Jetting	400	2500	2	-
LD Travocean - ROVJET 605	LP ROV LP ROV Tracked / Free flying	Jetting	600	1000	2.2	-
LD Travocean - ROVJET1200	HP ROV Tracked / Free flying	Jetting	1200	500	3	-
LD Travocean - ROVJET1612	Tracked / Free Swimming Combination	Jetting	1600	500	3	-
LD Travocean – TJV06	Jet Sled	Jetting	300	60	2	-
LD Travocean – TM03	Tractor	Cutting	450	120	2.3	-
NKT – Jet Plough	Plough (75Te Tow force)	Ploughing + jetting	1000		2.1	200
Nexans Capjet mini	HP ROV Wheeled	Jetting	1341	50	-	-
Nexans CapJet A	HP ROV Wheeled/skid	Jetting	1341	1550	3.2	-
Nexans CapJet B	HP ROV Wheeled/skid	Jetting	268	1000	3.2	40
Pharos Q1000	HP ROV Tracked / skid	Jetting	1000	1000	3.0	-
Prysmian - Seamole	HP ROV Tracked	Jetting	1200	2000	2.4	-
Prysmian – SeaRex (SMD BT2100)	Tractor	Cutting & Jetting	-	500	2.5 / 3.0	10000 / -
Prysmian – HD3	Plough (150Te Tow force)	Ploughing + jetting	335	1000	3.3	-
Prysmian – Hydroplow	Jet Sled	Jetting	1273	50	2 - 6	-
Van Oord Dig-it (SMD Q1600)	HP ROV - Tracked	Jetting / Cutting	1600	1000	3 / 1.6 - 2.0	-

3. GEOLOGICAL ASSESSMENT

3.1 Introduction

This section presents the breakdown of the Kattegat cable route based on seabed conditions indicated to be present following a review of the available geotechnical and geophysical data.

The geotechnical information has been assessed and categorised based on parameters from the CPT logs such as tip resistance and undrained shear strength. **Table 3-1** outlines the limits that define the descriptors used when describing granular material for the BAS zones. **Table 3-2** outlines the limits that define the descriptors used when describing cohesive material for the BAS zones. These follow BS EN ISO 14688-2:2004.

Table 3-1 Granular Material Density Classification

Relative Density	Tip Resistance (q_c MPA)	Intertek Assumed Density ($D_r\%$)
Very Loose	0 – 2.5	<15
Loose	2.5 – 5	15 – 35
Medium Dense	5 – 10	35 – 65
Dense	10 – 20	65 – 85
Very Dense	>20	> 85

Table 3-2 Cohesive Material Intrinsic Strength

Consistency Descriptor	Approximate q_c range for MPa (Tip Resistance)	Intertek Assumed Shear Strength (KPa)
Very Soft (Extremely Low)	0 – 0.4	<10
Soft (Very Low)	0.4 – 0.8	10 – 20
Firm (Low)	0.8 – 1.5	20 – 40
Still (Medium)	1.5 – 3	40 – 75
Very Stiff (High)	> 3	75 – 150
Hard (Very High)		> 150

3.2 Methodology for Geological Assessment/Groupings

This study uses the geological ground model and zonation interpreted for the Cable Burial Risk Assessment using the data listed in **Table 1-2** provided at the time of analysis. It is important to note that, as of the completion of this analysis and the writing of this report, the geophysical interpretation, geotechnical factual and integrated reports were not available from the survey contractor. Additionally, no alignment charts were available. Intertek's analysis of the soils conditions along the route is based solely on the analysis of the draft geotechnical coring and cone penetrometer logs.

3.3 Geological Zones

A total of 27 geological zones have been identified along the cable route from the Cable Burial Risk Assessment Study.

Table 3-3 Geological Zones

Zone	Geology - Upper 3m below seabed	Start KP	End KP
1	0.1 of Extremely Low Strength clay overlying medium Dense Sand	0.00	4.00
2	0.1 of Extremely Low Strength clay, 0.9 of low strength clay overlying medium dense sand	3.995	7.745
3	0.1 of Extremely Low Strength Clay, 1.3 of Low Strength clay overlying High Strength Clay	7.745	9.535
4	0.2 of Extremely Low Strength Clay, 0.6 of Very Low Strength Clay overlying Medium Dense Sand	9.535	10.235
5	0.1 of Extremely Low Strength clay, 1.2 of Low Strength Clay overlying Medium Dense Sand	10.235	13.785
6	0.1 of Extremely Low Strength clay, 2 of Very Low Strength Clay overlying Medium Dense Sand	13.785	17.175
7	0.1 of Extremely Low Strength clay overlying Low Strength Clay	17.175	18.795
8	0.1 of Extremely Low Strength Clay, 1 of Very Low Strength Clay, overlying Medium Dense Sand	18.795	20.735
9	0.2 of Loose Sand, 1.4 of Very Low Strength Clay, 0.4 of Loose Sand	20.735	21.535
10	0.2 of Extremely Low Strength Clay, 1.6m of Very Low Strength Clay, 0.7 of Very Loose Sand	21.535	22.02
11	0.2 of Extremely Low Strength Clay, 1.4 of Very Low Strength Clay overlying Medium Dense Sand	22.02	22.53
12	0.2 of Extremely Low Strength Clay, 1.4 of Very Low Strength Clay overlying Medium Dense Sand	22.53	24.5
13	0.3 of Extremely Low Strength Clay, 0.6 of Very Low Strength Clay, overlying Medium Dense Sand	24.5	25.475
14	0.1 of Extremely Low Strength Clay, 1.3 of Very Low Strength Clay, Overlying Medium Dense Sand	25.475	26.275
15	0.15, of Extremely Low Strength Clay, 1m of Very Low Strength Clay overlying Loose Sand	26.275	27.34
16	0.15, of Extremely Low Strength Clay, 1m of Very Low Strength Clay overlying Loose Sand	27.34	31.02
17	0.1, of Extremely Low Strength Clay, 1m of Very Low Strength Clay overlying Medium Dense Sand	31.02	31.55
18	0.1 of Extremely Low Strength Clay, 1m of Very Low Strength Clay overlying Loose Sand	31.55	32.29
19	0.05, of Extremely Low Strength Clay, 0.5m of Medium Dense Sand, overlying Low Strength Clay	32.29	33.405

Zone	Geology - Upper 3m below seabed	Start KP	End KP
20	0.1, of Extremely Low Strength Clay, overlying Medium Dense Sand	33.405	34.41
21	0.1, of Extremely Low Strength Clay, 0.6 of Loose Sand overlying Medium Dense Sand	34.41	35.27
22	0.2, of Extremely Low Strength Clay, 0.6 of Very Low Strength Clay overlying Medium Dense Sand	35.27	36.165
23	0.35, of Loose Sand, 1.6 of Medium Strength Clay overlying Medium Dense Sand	36.165	36.65
24	0.1, of Extremely Low Strength Clay, 0.5 of Very Low Strength Clay overlying Medium Dense Sand	36.65	37.255
25	0.3, of Very Low Strength Clay, overlying Medium Dense Sand	37.255	38.23
26	0.2 of Very Low Strength Clay. 0.4 of Low Strength overlying Medium Dense Sand	38.23	39.185
27	0.2 of Extremely Low Strength Clay, 0.4 of Very Low Strength Clay overlying Medium Dense Sand	39.185	41

3.4 Pre-installation Activities

Pre-installation activities for the cable installation depend on soil conditions and seabed features along the route. These activities might include but not be limited to pre lay grapnel run (PLGR), boulder removal, sandwave pre-sweeping, UXO identification and clearance, construction of third-party asset crossings and pre-trenching.

It was beyond the scope of this study to define these activities in detail, but the anticipated pre-installation activities are detailed in the BAS table in **Appendix B**.

3.5 Crossing of Third-party Assets

The route does not cross third-party assets.

4. BURIAL ASSESSMENT STUDY

This section combines the geological assessment and (Section 3) and the cable burial methods (Section 2) to determine appropriate burial strategy and tool requirements.

The geological assessment has identified 27 different zones along the cable route. The zones are based on areas with similar soils and the required DoL from the CBRA.

The six burial methods discussed in **Section 2** are categorised as follow:

- Low Power ROV Jetting - free flying/skid/tracked jet trenchers <800HP.
- High Power ROV Jetting - Tracked / skid ROV jet trenchers >1000HP.
- Towed jet sled.
- Tractor jet trencher
- Cable plough
- High Power ROV / Tractor chain cutter

Against each zone the six burial methods have a RAG performance rating applied indicating their suitability and performance for the soil conditions present and required DoL. The rating is presented in **Table 4-1**.

Table 4-1 Performance Ratings

Notation	Description	Tool Requirements
H	High Performance	Tool is suitable and the required DoL should be achieved.
M	Moderate Performance	Tool is suitable but DoL may not be achieved over the entire zone.
L	Low Performance	Tool is not suitable and DoL may not be achieved.

Where High performance is indicated for the entire route, those tools are considered capable of achieving the required DoL in a single pass. Where Moderate performance is indicated, it is possible that the required DoL may not be achieved along the entire route, necessitating remedial measures, or a combination of methods. Where Low performance is indicated, these tools are either considered to be unnecessary (e.g. cutting tools in jettable soils) or unsuitable (e.g. Tractor trencher sinking into very soft seabed). An overview of the BAS results can be found in **Table 4-2**. The full BAS table is in **Appendix B**.

Table 4-2 BAS Overview Table

Zone	Geology - Upper 3m Below Seabed	Start KP	End KP	Segment Distance (km)	DOL	LP ROV Jetting	HP ROV Jetting	Jet Sled	Tractor Jetting	Cable Plough	Chain Cutter
1	0.1 of Extremely Low Strength clay overlying medium Dense Sand	0.00	4.00	3.995	0.6	H	H	H	H	H	L
2	0.1 of Extremely Low Strength clay, 0.9 of low strength clay overlying medium dense sand	3.995	7.745	3.75	1.1	H	H	H	L	H	L
3	0.1 of Extremely Low Strength Clay, 1.3 of Low Strength clay overlying High Strength Clay	7.745	9.535	1.79	1.2	M	H	M	L	H	H
4	0.2 of Extremely Low Strength Clay, 0.6 of Very Low Strength Clay overlying Medium Dense Sand	9.535	10.235	0.7	1	H	H	H	L	H	L
5	0.1 of Extremely Low Strength clay, 1.2 of Low Strength Clay overlying Medium Dense Sand	10.235	13.785	3.55	1.2	H	H	H	L	H	L
6	0.1 of Extremely Low Strength clay, 2 of Very Low Strength Clay overlying Medium Dense Sand	13.785	17.175	3.39	1.2	H	H	H	L	H	L
7	0.1 of Extremely Low Strength clay overlying Low Strength Clay	17.175	18.795	1.62	1.2	H	H	H	L	H	L
8	0.1 of Extremely Low Strength Clay, 1 of Very Low Strength Clay, overlying Medium Dense Sand	18.795	20.735	1.94	1.15	H	H	H	L	H	L
9	0.2 of Loose Sand, 1.4 of Very Low Strength Clay, 0.4 of Loose Sand	20.735	21.535	0.8	1.05	H	H	H	L	H	L
10	0.2 of Extremely Low Strength Clay, 1.6m of Very Low Strength Clay, 0.7 of Very Loose Sand	21.535	22.02	0.485	1.05	H	H	H	L	H	L
11	0.2 of Extremely Low Strength Clay, 1.4 of Very Low Strength Clay overlying Medium Dense Sand	22.02	22.53	0.51	1.05	H	H	H	L	H	L
12	0.2 of Extremely Low Strength Clay, 1.4 of Very Low Strength Clay overlying Medium Dense Sand	22.53	24.5	1.97	1.25	H	H	H	L	H	L
13	0.3 of Extremely Low Strength Clay, 0.6 of Very Low Strength Clay, overlying Medium Dense Sand	24.5	25.475	0.975	0.9	H	H	H	L	H	L
14	0.1 of Extremely Low Strength Clay, 1.3 of Very Low Strength Clay, Overlying Medium Dense Sand	25.475	26.275	0.8	1.2	H	H	H	L	H	L

Zone	Geology - Upper 3m Below Seabed	Start KP	End KP	Segment Distance (km)	DOL	LP ROV Jetting	HP ROV Jetting	Jet Sled	Tractor Jetting	Cable Plough	Chain Cutter
15	0.15, of Extremely Low Strength Clay, 1m of Very Low Strength Clay overlying Loose Sand	26.275	27.34	1.065	1.2	H	H	H	L	H	L
16	0.15, of Extremely Low Strength Clay, 1m of Very Low Strength Clay overlying Loose Sand	27.34	31.02	3.68	1.5	H	H	H	L	H	L
17	0.1, of Extremely Low Strength Clay, 1m of Very Low Strength Clay overlying Medium Dense Sand	31.02	31.55	0.53	1.15	H	H	H	L	H	L
18	0.1 of Extremely Low Strength Clay, 1m of Very Low Strength Clay overlying Loose Sand	31.55	32.29	0.74	1.15	H	H	H	L	H	L
19	0.05, of Extremely Low Strength Clay, 0.5m of Medium Dense Sand, overlying Low Strength Clay	32.29	33.405	1.115	0.6	H	H	H	H	H	L
20	0.1, of Extremely Low Strength Clay, overlying Medium Dense Sand	33.405	34.41	1.005	0.6	H	H	H	H	H	L
21	0.1, of Extremely Low Strength Clay, 0.6 of Loose Sand overlying Medium Dense Sand	34.41	35.27	0.86	0.8	H	H	H	H	H	L
22	0.2, of Extremely Low Strength Clay, 0.6 of Very Low Strength Clay overlying Medium Dense Sand	35.27	36.165	0.895	0.75	H	H	H	L	H	L
23	0.35, of Loose Sand, 1.6 of Medium Strength Clay overlying Medium Dense Sand	36.165	36.65	0.485	0.95	L	H	M	L	H	H
24	0.1, of Extremely Low Strength Clay, 0.5 of Very Low Strength Clay overlying Medium Dense Sand	36.65	37.255	0.605	0.75	H	H	H	L	H	L
25	0.3, of Very Low Strength Clay, overlying Medium Dense Sand	37.255	38.23	0.975	0.6	H	H	H	L	H	L
26	0.2 of Very Low Strength Clay. 0.4 of Low Strength overlying Medium Dense Sand	38.23	39.185	0.955	0.95	H	H	H	L	H	L
27	0.2 of Extremely Low Strength Clay, 0.4 of Very Low Strength Clay overlying Medium Dense Sand	39.185	41	1.815	1	H	H	H	L	H	L

5. CONCLUSIONS

5.1 Burial Tool Assessment Results

The interpretation of geophysical/geotechnical data for the North Sea Nymindégab North route has identified 27 different zones.

Each trenching tool method has been assessed as shown in the BAS table, for each zone, and the results are as follows:

Table 5-1 Burial Tool Assessment Results

Trenching Method	Trenching Method Performance
LP Jetting ROV	Low performance in one zone where non jettable soils are present within trench depth.
HP Jetting ROV	High performance in all zones as soils within operational limits are present.
Jet Sled	Moderate performance expected in two zones with medium - high strength clay
Tractor Jetting	Low performance in most zones due to sinkage in very soft seabed.
Plough	High Performance in all zones as soils within operational limits are present.
Chain Cutting	Low performance in most zones due to sinkage in very soft seabed.

For the North Sea Nymindégab North cable route the high powered Jetting ROV should achieve the depth of lowering in zones 4 to 28. For zone 1 to 3, as water depth <10m, specialist nearshore jetting tools would be recommended. Cable ploughs should achieve depth of lowering in all zones.

5.2 Potential Contractors

A non-exhaustive list of potential marine contractors who currently have HP jetting ROV and cable plough capabilities are listed in Table 5-2 below.

Table 5-2 Contractors

Marine Cable Contractors	HP Jetting ROV	Plough
Asso Subsea	Yes	
Boskalis		Yes
Deep Ocean	Yes	Yes
Deme	Yes	
Engineering Technology Applications		Yes
Enshore		Yes
Global Marine		Yes
Helix Robotics	Yes	Yes
Jan de Nul	Yes	Yes
JD-Contractor		

Marine Cable Contractors	HP Jetting ROV	Plough
Loius Dreyfus TravOcean	Yes	Yes
Nexans	Yes	
NKT		Yes
Pharos	Yes	
Prysmian	Yes	Yes
Van Oord	Yes	

REFERENCES

- 1 GEOxyz, 2024. Bathymetry

- 2 GEOxyz, 2024. Geotechnical Report and VC & CPT logs

- 3 GEOxyz, 2024. Geotechnical Sample Locations Shapefile

- 4 Intertek, 2024. North Sea I - Nymindégab North Export Cable Route Cable Burial Risk Assessment

- 5 Brunning, Paul & Machin, J.. (2014). Applications and Performance of Trenching Technologies in Asia-Pacific. 10.4043/24833-MS.

- 6 BS EN ISO 14688-2:2004 Geotechnical investigation and testing. Identification and classification of soil. Principles for a classification

APPENDIX A

Market Assessment – Available Tools

A.1.1 Jetting Only

Jetting Only

Jan De Nul - PT1



- Total Power = 2049 HP (150 kW)
- 2000m max water depth
- 2.0m max trenching depth
- Maximum kPa for cohesive sediments not stated

Nexans CapJet Mini



- Power output 1341 HP (1 MW system)
- Maximum water depth = 50m
- Maximum soil strength: Unknown

Nexans CapJet A

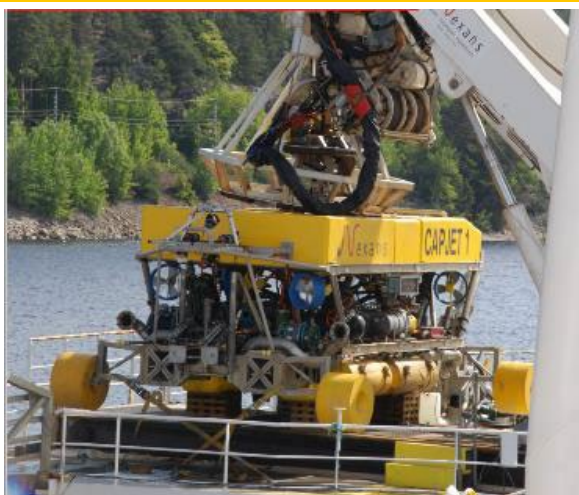

- Power output 1341 HP (1000 kW)
- Maximum water depth = 1000m or 1550m
- Jetting mode 3.2m max trench depth
- Maximum soil strength: not defined

Nexans CapJet B

Jetting Only



- Power output not defined.
- 268 HP (200 kW water pumps) 20-30 bars pressure
- Maximum water depth = 1000m or 1550m
- Jetting mode 3.2m max trench depth
- Maximum soil strength: 40kPa

JD-Contractor A/S Subjet III



- Power output 400 HP (300 kW) jetting Power (18 Bar @ 450 m³/h)
- 200m maximum water depth
- 1.8m max trenching depth
- kPa range not defined

Assodivers – AssoJet III Mk1



- Power output 697 HP (2x 260 kW)
- 1500m max water depth
- Jetting mode 3.0m max trenching depth
- Suitable for soils with shear up to 120-150 kPa

Assodiver – AssoJet III Mk2

Jetting Only



- Power output 697 HP (2x260 kW)
- 1500m max water depth
- Jetting mode 3.2m max trenching depth
- Suitable for soils with shear up to 120-150 kPa

DeepOcean UT-1

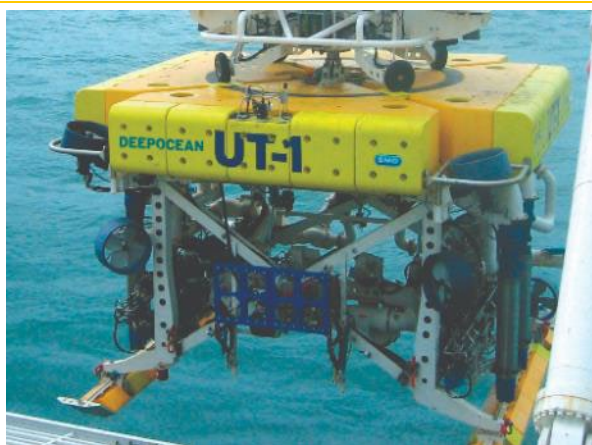

- Power output 2816 HP (2.1 MW)
- 1500m maximum water depth
- Jetting mode 3.0m max trench depth.
- Suitable for a range of soil types, including sands to soft clays” typically up to 25 kPa.

Prysmian - SeaMole



- Power output 1200 HP (Total Jetting Power = 1000 HP (745 kW))
- 2000m max water depth
- Jetting mode 3.0m max trenching depth. 2.5m trenching depth in “strong soils” kPa values not defined.

LD Travocean 400

Jetting Only



- Power output 400 HP (300 kW)
- 2500 max water depth
- 2.0m max trenching depth
- kPa range not defined

LD Travocean 605



- Total power = 600 HP (440 kW)
- 1000m water depth
- 2.2m max trenching depth
- kPa range not defined

Asso Hydroplow



- 150m maximum water depth
- 4.0m max trenching depth
- Suitable for soils with shear up to 120 kPa

Enshore T1 Trencher

Jetting Only

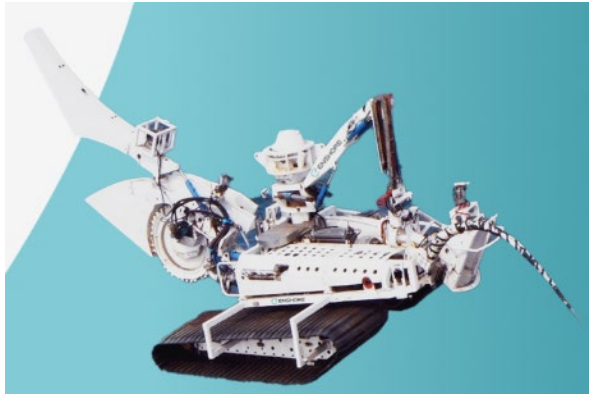

- Total power 697 HP
- 1000m maximum water depth
- 2.0m max trenching depth
- Suitable for soils with shear up to 20 kPa

Deep Ocean T1000



- Total power 1000 HP
- 2000m maximum water depth
- 3.0m max trenching depth
- Suitable for soils with shear up to 80 kPa

Global Marine – Atlas

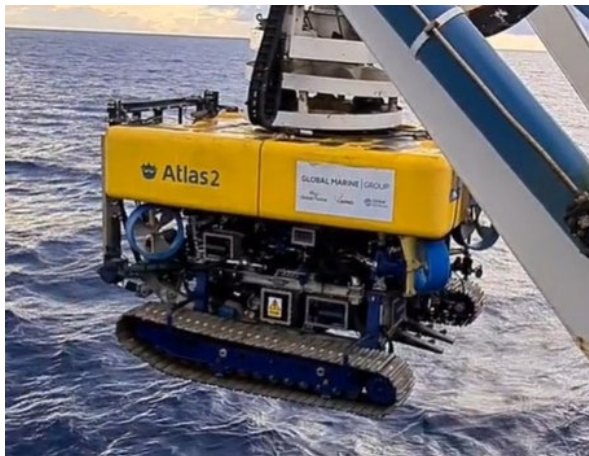

- Total power 400 HP
- 2000m maximum water depth
- 2.0m max trenching depth
- Suitable for soils with shear up to 100 kPa

Helix Robotics T-1200

Jetting Only



- Total power 1200 HP
- 3000m maximum water depth
- 3.0m max trenching depth
- Suitable for soils with shear up to 120 kPa

Helix Robotics T-1500



- Total power 1500 HP
- 3000m maximum water depth
- 3.0m max trenching depth
- Suitable for soils with shear up to 150 kPa

LD Travocean - ROVJET1200



- Total power 1200 HP
- 500m maximum water depth
- 3.0m max trenching depth

LD Travocean - ROVJET1612

Jetting Only



- Total power 1600 HP
- 500m maximum water depth
- 3.0m max trenching depth

LD Travocean – TJV06

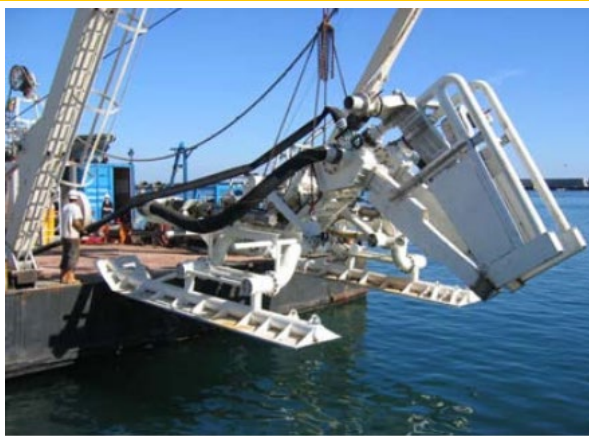

- Total power 300 HP
- 60m maximum water depth
- 2.0m max trenching depth

Pharos Q1000



- Total power 1000 HP
- 1000m maximum water depth
- 3.0m max trenching depth

Prysmian - Hydroplow

Jetting Only

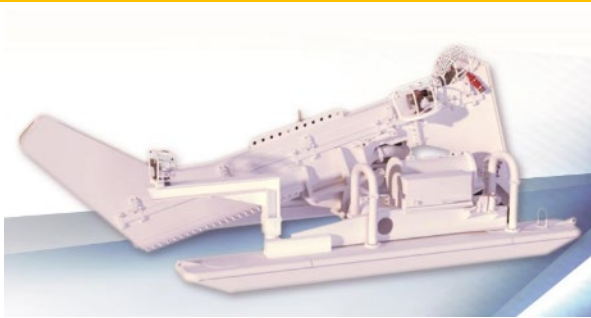

- Total power 1273 HP
- 50m maximum water depth
- 2.0 - 6.0m max trenching depth

A.1.2 Cutting Only

Cutting Only

Helix Robotics -i-Trencher

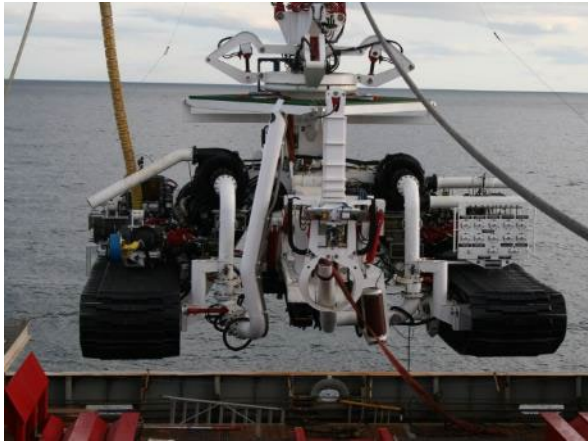

Power output 1680 HP (1250 kW)

1500m maximum water depth

Cutting mode: 2.7m max trench depth.

Suitable for a range of soil types, including sands and very soft to hard clays. up to 600 kPa.

AssoTrencherIV Mk9



Power output 2091 HP (1560 kW)

1500m maximum water depth

Cutting chain mode: 2.25m max trench depth.
Suitable for a range of hard sediments to very weak rock - 3 MPa

Cutting wheel mode: 1.25m max trench depth.
Suitable for a range of hard sediments to weak / moderately strong rock - 50 MPa

AssoTrencherIV Mk12



Power output 2091 HP (1560 kW)

1500m maximum water depth

Cutting chain mode: 2.3m max trench depth. Suitable for a range of hard sediments to very weak rock - 3 MPa

Cutting wheel mode: 1.25m max trench depth.
Suitable for a range of hard sediments to weak / moderately strong rock - 50 MPa

AssoTrenchersIV Mk13

Cutting Only



- Power output 2091 HP
- 800m maximum water depth
- Cutting chain mode: 2.3m max trench depth. Suitable for a range of hard sediments to very weak rock - 3 MPa
- Cutting wheel mode: 1.25m max trench depth. Suitable for a range of hard sediments to weak / moderately strong rock - 50 MPa

LD Travocean – TM03



- Power output 450 HP
- 120m maximum water depth
- Max Trench Depth 2.3m

A.1.3 Jetting / Cutting

Jetting / Cutting

Prysmian – SeaRex

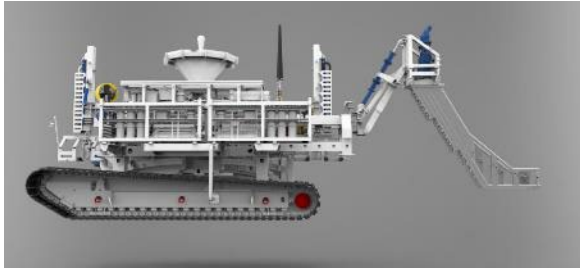

- Power output not provided
- 500m maximum water depth
- Jetting mode 3.0m max jet trenching depth kPa not defined.
- Chain cutter mode 2.5m max trenching depth at soils 10 MPa.
- Wheel cutter mode 1.5m max trenching depth in sediments up to 50MPa.

Jan De Nul – UTV 1200



- Power output 1200 HP (900 kW)
- 500m maximum water depth
- Jetting mode 3m max trenching depth for soils up to 100 kPa
- Chain cutting mode 1.6m max trench depth in soils up to 400 kPa

Asso Trencher V – Mk3

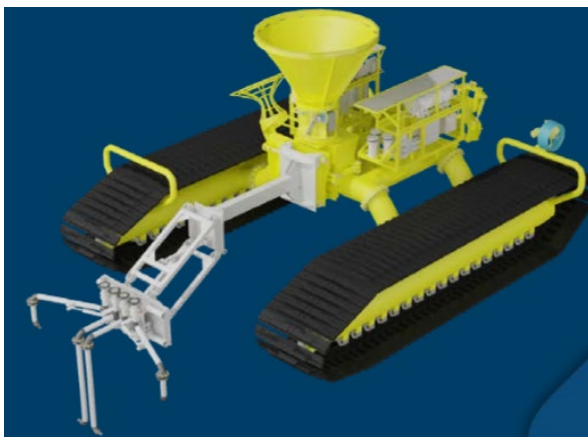

- Power output 737 HP (550 kW)
- 200m max water depth
- Jetting mode 2.2m max trench depth for soils of up to 120kPa
- Chain cutting mode 2.2m max trench depth for soils of up to 3MPa
- Wheel cutter mode 1.3m max trench depth for soils of up to 50MPa
- Cutting mode 1.0m max back jetting swords to prevent material collapsing and backfilling trench.

SMD QTrencher 1600 (e.g., Van Oord's Digt)

Jetting / Cutting



- Power output 1600 HP (1200 kW)
- 3000m max water depth
- Jetting mode 3.0m max jet trenching depth. "Suitable for soils with shear up to 100 kPa"
- Chain cutter mode to 2.0m max trench depth.
- Rock cutter wheel to 1.2m max trench depth.

Global Marine – Hi Plough



- Power output 670 HP
- 2000m max water depth
- Jetting mode 3.25m max jet trenching depth. Suitable for soils with shear up to 150 kPa

Jan De Nul - Swordfish



- Power output 1600 HP
- 500m max water depth
- Jetting mode 3.5m max jet trenching depth.
- Suitable for soils with shear up to 400 kPa in Jetting mode, 125 kPa in cutting mode.

A.1.4 Cutting & Jetting (Hybrid)

Cutting & Jetting (Hybrid)

Boskalis CBT2400

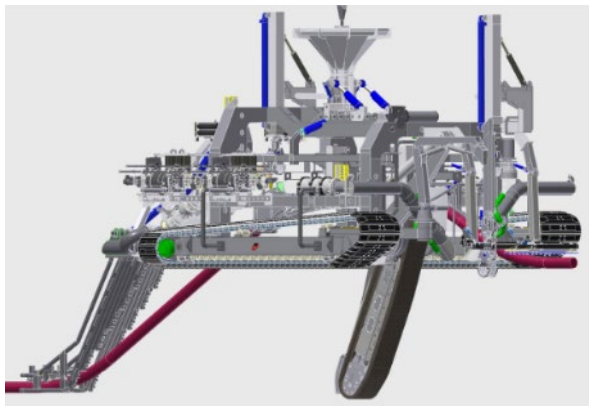

- Power output 2400 HP
- 1000m max water depth
- Max trenching depth of 3.3m

Enshore ENS1600

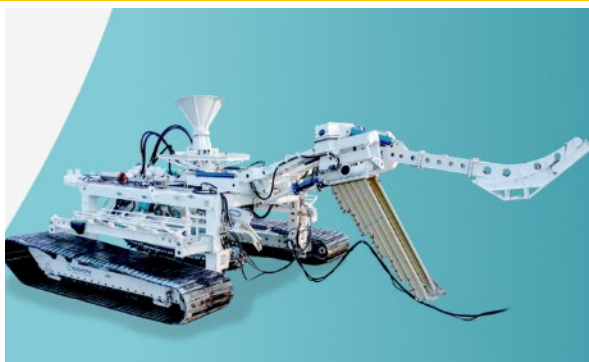

- Power output 1610 HP
- 1500m max water depth
- Max trenching depth of 5.0 m
- Suitable for soils with shear up to 75 kPa

Helix Robotics T1400



- Power output 1400 HP
- 1500m max water depth
- Max trenching depth of 2.0 m
- Suitable for soils with shear up to 250 kPa

A.1.5 Ploughing

Ploughing

Enshore PCP



- Power output 400 HP
- 1500m max water depth
- Max trenching depth of 2.4 m
- Suitable for soils with shear up to 300 – 600 kPa

APPENDIX B

Burial Assessment Table

Table B-1 Granular Material Density Classification

Relative Density	Tip Resistance (q_c MPA)	Intertek Assumed Density (Dr%)
Very Loose	0 – 2.5	<15
Loose	2.5 – 5	15 – 35
Medium Dense	5 – 10	35 – 65
Dense	10 – 20	65 – 85
Very Dense	>20	> 85

Table B-2 Cohesive Material Intrinsic Strength

Consistency Descriptor	Approximate q_c range for MPa (Tip Resistance)	Intertek Assumed Shear Strength (KPa)
Very Soft (Extremely Low)	0 – 0.4	<10
Soft (Very Low)	0.4 – 0.8	10 – 20
Firm (Low)	0.8 – 1.5	20 – 40
Still (Medium)	1.5 – 3	40 – 75
Very Stiff (High)	> 3	75 – 150
Hard (Very High)		> 150

Table B-3 Performance Ratings

Notation	Description	Tool Requirements
H	High Performance	Tool is suitable and the required DoL should be achieved.
M	Moderate Performance	Tool is suitable but DoL may not be achieved over the entire zone.
L	Low Performance	Tool is not suitable and DoL may not be achieved.

Zone ID, EP and Length					Water Depth (m below LST)			Known Co-located Infrastructure/Obstacles	Shallow Soils Geology						Geotechnical data used		Post-up Activities				Recommended Minimum Depth of Laying (m)	LP ROV Rating	HP ROV Rating	Jet Sled	Trencher Rating	Cable Plough	Chain Cutter	Comments				
DIG ID	Zone ID	Start EP	End EP	Length (m)	M50	M55	M58		Layer 1 Dominant Sediment Type	Layer 1 Thickness (m)	Layer 1 Categorization for Anchor Penetration Calculation	Layer 2 Dominant Sediment Type	Layer 2 Thickness (m)	Layer 2 Categorization for Anchor Penetration Calculation	Layer 3 Dominant Sediment Type	Layer 3 Thickness (m)	Layer 3 Categorization for Anchor Penetration Calculation	Mobile Features (where applicable)	CPT	VC									FLOR	Seabed Preprocessing	Beacon removal	USD Identification and Clearance
1	1	0.00	4.00	4.00	6.3	0.0	2.0	None Present	CLAY/LLSILT	0.1	EXTREMELY LOW STRENGTH CLAY (<10 kPa)	SAND	2	MEDIUM DENSE SAND			Yes	GT_CPT_021 GT_VC_043	GT_VC_021 GT_VC_043	YES	Yes	NO	YES	0.60	H*	H*	H*	H*	H*	L*	As water depth <10m vessel not getting test required and measurability of ROV might be compromised *Performance rating based on specialist seabed tools only	
2	2	4.00	7.75	3.75	10.0	0.0	7.0	None Present	CLAY/LLSILT	0.1	EXTREMELY LOW STRENGTH CLAY (<10 kPa)	CLAY/LLSILT	0.9	MEDIUM STRENGTH CLAY (10 to <75 kPa)	SAND	2	MEDIUM DENSE SAND	No	GT_CPT_022 GT_CPT_023 GT_CPT_023	GT_VC_022 GT_VC_023 GT_VC_023	YES	No	NO	YES	1.10	H*	H*	H*	H*	H*	L*	As water depth <10m vessel not getting test required and measurability of ROV might be compromised *Performance rating based on specialist seabed tools only
3	3	7.75	9.54	1.79	12.2	0.7	11.0	None Present	CLAY/LLSILT	0.1	EXTREMELY LOW STRENGTH CLAY (<10 kPa)	CLAY/LLSILT	1.3	MEDIUM STRENGTH CLAY (10 to <75 kPa)	CLAY/LLSILT	0.8	HIGH STRENGTH CLAY (>75 kPa)	No	GT_CPT_024	GT_VC_024	YES	No	NO	YES	1.20	M*	H*	M*	L*	H*	H*	As water depth <10m vessel not getting test required and measurability of ROV might be compromised *Performance rating based on specialist seabed tools only
4	4	9.54	10.24	0.70	13.5	1.0	12.0	None Present	CLAY/LLSILT	0.2	EXTREMELY LOW STRENGTH CLAY (<10 kPa)	CLAY/LLSILT	0.6	MEDIUM STRENGTH CLAY (10 to <75 kPa)	SAND	0.4	MEDIUM DENSE SAND	No	GT_CPT_025	GT_VC_025	YES	No	NO	YES	1.00	H	H	H	L	H	L	
5	5	10.24	13.79	3.55	16.8	1.1	14.0	None Present	CLAY/LLSILT	0.1	EXTREMELY LOW STRENGTH CLAY (<10 kPa)	CLAY/LLSILT	1.2	MEDIUM STRENGTH CLAY (10 to <75 kPa)	SAND	0.8	MEDIUM DENSE SAND	No	GT_CPT_026 GT_CPT_027 GT_CPT_028 GT_CPT_029	GT_VC_026 GT_VC_027 GT_VC_028 GT_VC_029	YES	No	NO	YES	1.20	H	H	H	L	H	L	
6	6	13.79	17.38	3.59	18.4	1.4	17.0	None Present	CLAY/LLSILT	0.1	EXTREMELY LOW STRENGTH CLAY (<10 kPa)	CLAY/LLSILT	2	MEDIUM STRENGTH CLAY (10 to <75 kPa)	SAND	1.4	MEDIUM DENSE SAND	No	GT_CPT_028 GT_CPT_031 GT_CPT_032	GT_VC_028 GT_VC_031 GT_VC_032	YES	No	NO	YES	1.20	H	H	H	L	H	L	
7	7	17.38	18.80	1.42	19.3	1.5	18.0	None Present	CLAY/LLSILT	0.1	EXTREMELY LOW STRENGTH CLAY (<10 kPa)	CLAY/LLSILT	4	MEDIUM STRENGTH CLAY (10 to <75 kPa)			No	GT_CPT_033 GT_CPT_034	GT_VC_033 GT_VC_034 rev01	YES	No	NO	YES	1.20	H	H	H	L	H	L		
8	8	18.80	20.74	1.94	19.3	1.6	18.0	None Present	CLAY/LLSILT	0.1	EXTREMELY LOW STRENGTH CLAY (<10 kPa)	CLAY/LLSILT	1	MEDIUM STRENGTH CLAY (10 to <75 kPa)	SAND	4	MEDIUM DENSE SAND	No	GT_CPT_035	GT_VC_035 rev01	YES	No	NO	YES	1.15	H	H	H	L	H	L	
9	9	20.74	21.64	0.90	19.3	1.7	18.0	None Present	CLAY/LLSILT	0.2	EXTREMELY LOW STRENGTH CLAY (<10 kPa)	CLAY/LLSILT	1.4	MEDIUM STRENGTH CLAY (10 to <75 kPa)	SAND	0.4	LOOSE SAND	No	GT_CPT_036	GT_VC_036 rev01	YES	No	NO	YES	1.05	H	H	H	L	H	L	
10	10	21.64	22.03	0.40	19.3	1.5	17.0	None Present	CLAY/LLSILT	0.2	EXTREMELY LOW STRENGTH CLAY (<10 kPa)	CLAY/LLSILT	1.6	MEDIUM STRENGTH CLAY (10 to <75 kPa)	SAND	0.7	VERY LOOSE SAND	No	GT_CPT_037 GT_CPT_038	GT_VC_037 rev01 GT_VC_038	YES	No	NO	YES	1.05	H	H	H	L	H	L	
11	11	22.03	22.53	0.51	19.2	1.6	17.0	None Present	CLAY/LLSILT	0.2	EXTREMELY LOW STRENGTH CLAY (<10 kPa)	CLAY/LLSILT	1.4	MEDIUM STRENGTH CLAY (10 to <75 kPa)	SAND	2	MEDIUM DENSE SAND	No	GT_CPT_039 GT_CPT_040 GT_CPT_041	GT_VC_039 GT_VC_040 GT_VC_041	YES	No	NO	YES	1.05	H	H	H	L	H	L	
12	12	22.53	24.50	1.97	19.2	1.5	17.0	None Present	CLAY/LLSILT	0.2	EXTREMELY LOW STRENGTH CLAY (<10 kPa)	CLAY/LLSILT	1.4	MEDIUM STRENGTH CLAY (10 to <75 kPa)	SAND		MEDIUM DENSE SAND	No	GT_CPT_039 GT_CPT_040 GT_CPT_041	GT_VC_039 GT_VC_040 GT_VC_041	YES	No	NO	YES	1.25	H	H	H	L	H	L	
13	13	24.50	25.48	0.98	18.4	1.5	17.0	None Present	CLAY/LLSILT	0.1	EXTREMELY LOW STRENGTH CLAY (<10 kPa)	CLAY/LLSILT	0.6	MEDIUM STRENGTH CLAY (10 to <75 kPa)	SAND		MEDIUM DENSE SAND	No	GT_CPT_042	GT_VC_042	YES	No	NO	YES	0.90	H	H	H	L	H	L	
14	14	25.48	26.28	0.80	18.4	1.5	17.0	None Present	CLAY/LLSILT	0.1	EXTREMELY LOW STRENGTH CLAY (<10 kPa)	CLAY/LLSILT	1.3	MEDIUM STRENGTH CLAY (10 to <75 kPa)	SAND	4.6	MEDIUM DENSE SAND	No	GT_CPT_043	GT_VC_043	YES	No	NO	YES	1.20	H	H	H	L	H	L	
15	15	26.28	27.34	1.07	19.3	1.7	18.0	None Present	CLAY/LLSILT	0.15	EXTREMELY LOW STRENGTH CLAY (<10 kPa)	CLAY/LLSILT	1	MEDIUM STRENGTH CLAY (10 to <75 kPa)	SAND	1.2	LOOSE SAND	No	GT_CPT_044 GT_CPT_045 GT_CPT_046 GT_CPT_047 GT_CPT_048 GT_CPT_049	GT_VC_044 GT_VC_045 GT_VC_046 GT_VC_047 GT_VC_048 GT_VC_049	YES	No	NO	YES	1.20	H	H	H	L	H	L	
16	16	27.34	31.02	3.68	22.0	1.8	21.0	None Present	CLAY/LLSILT	0.15	EXTREMELY LOW STRENGTH CLAY (<10 kPa)	CLAY/LLSILT	1	MEDIUM STRENGTH CLAY (10 to <75 kPa)	SAND	1.2	LOOSE SAND	No	GT_CPT_044 GT_CPT_045 GT_CPT_046 GT_CPT_047 GT_CPT_048 GT_CPT_049	GT_VC_044 GT_VC_045 GT_VC_046 GT_VC_047 GT_VC_048 GT_VC_049	YES	No	NO	YES	1.50	H	H	H	L	H	L	
17	17	31.02	31.95	0.93	22.0	2.0	22.0	None Present	CLAY/LLSILT	0.1	EXTREMELY LOW STRENGTH CLAY (<10 kPa)	CLAY/LLSILT	1	MEDIUM STRENGTH CLAY (10 to <75 kPa)	SAND	4	MEDIUM DENSE SAND	No	GT_CPT_050	GT_VC_050	YES	No	NO	YES	1.15	H	H	H	L	H	L	
18	18	31.95	32.29	0.34	23.0	2.0	22.0	None Present	CLAY/LLSILT	0.1	EXTREMELY LOW STRENGTH CLAY (<10 kPa)	CLAY/LLSILT	1	MEDIUM STRENGTH CLAY (10 to <75 kPa)	SAND	4	LOOSE SAND	No	GT_CPT_051	GT_VC_051	YES	No	NO	YES	1.15	H	H	H	L	H	L	
19	19	32.29	33.41	1.12	23.0	2.0	23.0	None Present	CLAY/LLSILT	0.05	EXTREMELY LOW STRENGTH CLAY (<10 kPa)	SAND	0.5	MEDIUM DENSE SAND	CLAY/LLSILT	1.45	MEDIUM STRENGTH CLAY (10 to <75 kPa)	No	GT_CPT_052	GT_VC_052	YES	No	NO	YES	0.60	H	H	H	H	H	L	
20	20	33.41	34.41	1.01	23.7	2.4	23.0	None Present	CLAY/LLSILT	0.1	EXTREMELY LOW STRENGTH CLAY (<10 kPa)	SAND	5	MEDIUM DENSE SAND			No	GT_CPT_053	GT_VC_053	YES	No	NO	YES	0.60	H	H	H	H	H	L		
21	21	34.41	35.27	0.86	24.0	2.7	23.0	None Present	CLAY/LLSILT	0.1	EXTREMELY LOW STRENGTH CLAY (<10 kPa)	SAND	0.6	LOOSE SAND	SAND	2.2	MEDIUM DENSE SAND	No	GT_CPT_054	GT_VC_054	YES	No	NO	YES	0.80	H	H	H	H	H	L	
22	22	35.27	36.17	0.90	24.3	2.0	24.0	None Present	CLAY/LLSILT	0.2	EXTREMELY LOW STRENGTH CLAY (<10 kPa)	CLAY/LLSILT	0.2	MEDIUM STRENGTH CLAY (10 to <75 kPa)	SAND	2.2	MEDIUM DENSE SAND	No	GT_CPT_055	GT_VC_055	YES	No	NO	YES	0.75	H	H	H	L	H	L	
23	23	36.17	36.65	0.48	24.3	2.4	23.0	None Present	SAND	0.25	LOOSE SAND	CLAY/LLSILT	1.6	MEDIUM STRENGTH CLAY (10 to <75 kPa)	SAND	1.8	MEDIUM DENSE SAND	No	GT_CPT_056	GT_VC_056	YES	No	NO	YES	1.35	L	H	M	L	H	H	LP rating and jet sled may not achieve the required DCL in a single pass. Subsequent removal capacity of most of ROV jet sleds and jet sleds, resulting in reduced DCL.
24	24	36.65	37.26	0.60	24.7	2.5	24.2	None Present	CLAY/LLSILT	0.1	EXTREMELY LOW STRENGTH CLAY (<10 kPa)	CLAY/LLSILT	0.4	MEDIUM STRENGTH CLAY (10 to <75 kPa)	SAND	2.8	MEDIUM DENSE SAND	Yes	GT_CPT_057	GT_VC_057	YES	Yes	NO	YES	1.05	H	H	H	L	H	L	
25	25	37.26	38.23	0.98	25.1	2.0	24.0	None Present	CLAY/LLSILT	0.3	MEDIUM STRENGTH CLAY (10 to <75 kPa)	SAND	5	MEDIUM DENSE SAND			Yes	GT_CPT_058	GT_VC_058	YES	Yes	NO	YES	0.60	H	H	H	L	H	L		
26	26	38.23	39.19	0.95	25.6	2.4	25.0	None Present	CLAY/LLSILT	0.2	MEDIUM STRENGTH CLAY (10 to <75 kPa)	SAND	0.4	LOOSE SAND	SAND	3	MEDIUM DENSE SAND	Yes	GT_CPT_059	GT_VC_059	YES	Yes	NO	YES	1.05	H	H	H	L	H	L	
27	27	39.19	39.75	0.56	25.8	2.4	25.0	None Present	CLAY/LLSILT	0.2	EXTREMELY LOW STRENGTH CLAY (<10 kPa)	CLAY/LLSILT	0.4	MEDIUM STRENGTH CLAY (10 to <75 kPa)	SAND	2.6	MEDIUM DENSE SAND	No	GT_CPT_060 GT_CPT_061	GT_VC_060 GT_VC_061	YES	No	NO	YES	1.00	H	H	H	L	H	L	
28	28	39.75	41.00	1.25	26.5	2.5	26.0	None Present	CLAY/LLSILT	0.2	EXTREMELY LOW STRENGTH CLAY (<10 kPa)	CLAY/LLSILT	0.4	MEDIUM STRENGTH CLAY (10 to <75 kPa)	SAND	2.6	MEDIUM DENSE SAND	No	GT_CPT_060 GT_CPT_061	GT_VC_060 GT_VC_061	YES	No	NO	YES	1.00	H	H	H	L	H	L	